

# PROGRAMMER

INSTRUCTION MANUAL

---

Please read this manual before using the machine.  
Please keep this manual within easy reach for quick reference.

---

BAS-300F Series  
KE-436B, 436C

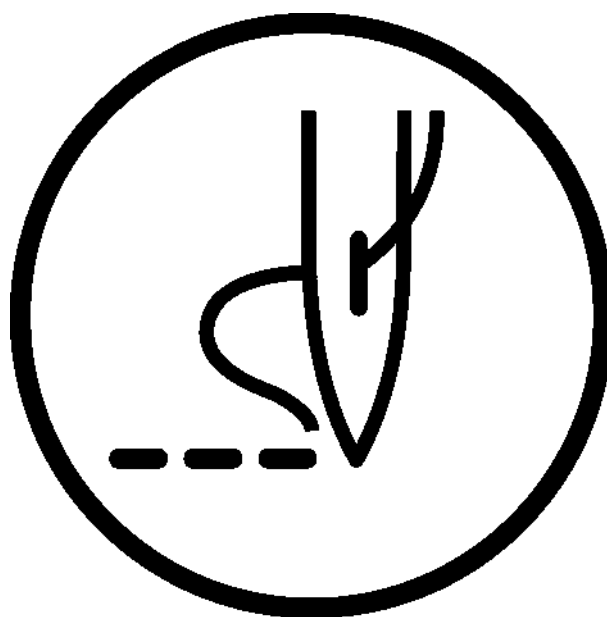

---

**brother**<sup>®</sup>

Thank you very much for purchasing the Brother Industrial Sewing Machine.

Please read this "Programmer Instruction Manual" and the separate volume "Instruction Manual" carefully before using the machine.





Operation of this industrial sewing machine is usually carried out in front of moving parts such as the needle and the needle thread take-up. These parts may cause personal injuries. Please follow the operational and safety instructions by the experts/instructors and use this machine correctly.



























# Contents

## Chapter 1 Preparations of operation

- Connection ..... 8
- Handling the programmer ..... 9
  - After use ..... 9
- Turning power ON/OFF ..... 10
  - Turning power ON ..... 10
  - Turning power OFF ..... 11
- Handling of floppy disk ..... 12
  - Protecting data in floppy disks ..... 13
  - Setting a Floppy Disk to the Floppy Disk Drive ..... 13
- Contents ..... 14
- Notes for programming ..... 15

## Chapter 2 Programming with Help Function

- Please read before programming ..... 18
  - Panel description and usage ..... 18
  - Display screen ..... 19
  - Programming flowchart ..... 20
- Description of icons ..... 22
  -  Programming ..... 22
  -  Displaying a pattern image ..... 24
  -  Checking the program setting and setting attribute ..... 24
  -  Editing data ..... 24
  -  Deleting data ..... 24
- Programming example ..... 25
  - Programming for each stitch ..... 25
  - Magnified input ..... 27
  - Lines ..... 29
  - Curve ..... 31
  - Double stitch ..... 34
  - Feed ..... 36
  - Basting ..... 38
  - Symmetrical pattern ..... 41
  - Splitting ..... 44
  - Zigzag stitch ..... 46
  - Multiple stitch ..... 48
- Example of modified program ..... 52
  - Resizing pattern ..... 52
  - Changing partially ..... 54
  - Deleting the first stitch ..... 57
  - Changing the first stitch position ..... 59
  - Adding sewing point before the first stitch ..... 62
  - Adding escape point before the first stitch ..... 65
  - Moving the escape point ..... 68
  - Deleting the escape point ..... 70
  - Moving the pattern in parallel 1 ..... 72
  - Moving the pattern in parallel 2 ..... 74
  - Deleting a part of the program during programming ..... 77
  - Moving a part of continuous program in parallel ..... 78
  - Moving a part of continuous program in parallel partially ..... 80
  - Canceling thread breakage at the last stitch ..... 82





 Programming .....	85
 Creating a line .....	85
 Creating a curve .....	85
 Creating a circle .....	86
 Creating an arc .....	88
 Creating a semicircle .....	89
 Creating a zigzag circle .....	90
 Creating a zigzag stitch .....	91
 Ending programming .....	93
 Creating needle drop data .....	94
 Creating feed data .....	94
 Creating basting data .....	95
 Creating split data .....	95
 Creating magnified data .....	96
 Carrying out double stitch .....	97
 Displaying the data image during programming .....	99
 Checking the program setting and setting attribute .....	100
 Editing the current data .....	100
 Deleting a part of data .....	103
 Setting low-speed sewing .....	104
 Inputting the trigger (BAS-300 Series) .....	105
 Creating a multiple stitch .....	106
 Displaying a pattern image .....	108
 Checking the program setting and setting attribute .....	109
Checking each stitch .....	110
Checking a series of stitches automatically .....	110
Skipping .....	110
 Editing program .....	113
 Deleting data .....	118

### Chapter 3 Programming with Command Function





Please read before programming .....	120
Panel description and usage .....	120
Display screen .....	121
Programming flowchart .....	121
Description of commands .....	123
Moving needle point .....	123
Deleting data .....	123
Ending programming .....	123
Creating program .....	124
Editing data .....	125
Setting attribute .....	126
Other operations .....	126
Programming example .....	127
Programming for each stitch .....	127
Resizing input .....	128
Lines .....	129
Curve .....	130
Double stitch .....	132
Feed .....	133

Basting.....	135
Symmetrical pattern.....	136
Splitting.....	138
Zigzag stitch .....	139
Multiple stitch.....	140
Example of modified program.....	144
Resizing pattern.....	144
Changing partially.....	146
Deleting the first stitch .....	147
Changing the first stitch position.....	149
Adding sewing point before the first stitch .....	150
Adding escape point before the first stitch.....	152
Moving the escape point.....	154
Deleting the escape point .....	155
Moving the pattern in parallel 1.....	156
Moving the pattern in parallel 2.....	157
Deleting a part of the program during programming .....	159
Moving a part of continuous program in parallel.....	159
Canceling thread breakage at the last stitch.....	161
Programming.....	163
Creating a line .....	163
Creating a curve .....	164
Creating a circle (zigzag circle) by specifying 3 points.....	165
Creating a circle (zigzag circle) by specifying the diameter .....	167
Creating a circle (zigzag circle) by specifying the radius .....	168
Creating an arc .....	170
Creating a semicircle .....	171
Creating a zigzag stitch .....	172
Creating a multiple stitch .....	173
Creating double stitch .....	175
Parallel stitch .....	176
Offset.....	177
Creating feed data .....	178
Creating split data.....	179
Creating magnified data.....	179
Low-speed sewing.....	180
Setting the option output.....	181
Ending programming .....	181
Editing data .....	182
Moving symmetrically to the Y axis.....	182
Moving symmetrically to the X axis.....	182
Moving symmetrically to a point.....	183
Rotating a pattern clockwise (counterclockwise) .....	184
Copying a pattern rotated clockwise (counterclockwise) .....	185
Resizing.....	186
Copying a pattern resized.....	187
Repeated copying.....	188
Copying symmetrically to a point.....	189
Copying to the X axis.....	189
Copying to the Y axis.....	190
Copying in the reverse direction .....	190
Moving in parallel.....	191
Displaying image .....	192
Deleting data .....	193
Deleting a part of data .....	193
Deleting program data .....	193

## Chapter 4 Extended Option Output (BAS-300 Series)

Function of extended option output.....	196
Operating the extended option output.....	196
Items which can be set in the extended option output.....	197
 Setting the extended option output.....	198
 Setting enabling conditions .....	199
 Reading the extended option output data.....	200
 Writing the extended option output data.....	201
 Deleting the extended option output data.....	202
Table of condition number .....	203
Machine operation mode.....	203
Standard input.....	203
Standard output .....	204
Extended option external input.....	204
Extended option output .....	205
Table of extended option input .....	206
Table of extended option output .....	207
Example of extended option output.....	208

## Chapter 5 Reading/Writing Data

 Reading data.....	212
 Reading additional data.....	214
 Writing data to a floppy disk .....	216
 Deleting data in a floppy disk .....	218
 Formatting a floppy disk .....	220
 Reading other types of data .....	221

## Chapter 6 Preference

 Setting preference.....	224
---	-----



# Chapter 1

## Preparations of operation



## Connection

---

Connection of the programmer cable to the machine is described here.

Check that the machine power is OFF before connecting the cable.

1. Connect the cable to the connector on the left side of the operation panel.

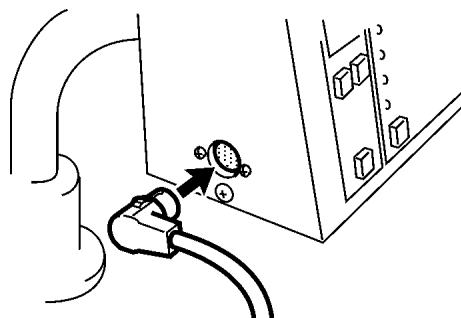

# Handling the programmer

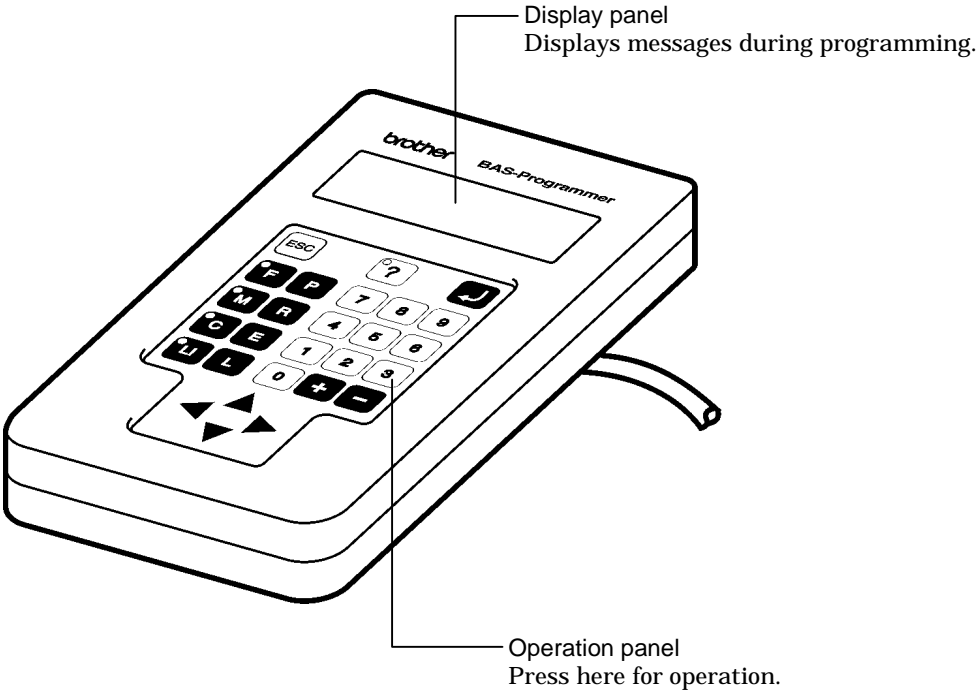

## After use

Wind the cable for storage as shown in the figure.

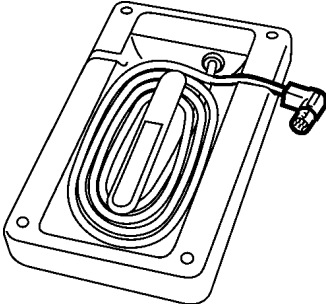

## Turning power ON/OFF

---

### Turning power ON

1. Switch ON the machine.

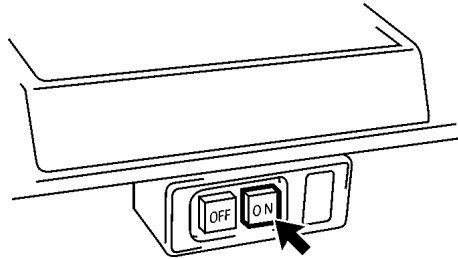

2. Press the foot switch pedal to lift the work clamp.

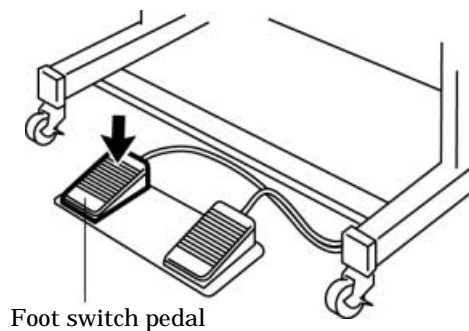

3. Set the pattern sheet.  
Fix the pattern sheet with adhesive tape on the feed plate to prevent displacement.

4. Press the foot switch pedal to lower the work clamp.
5. Moving the needle closer to the pattern sheet by turning the pulley allows easier programming.

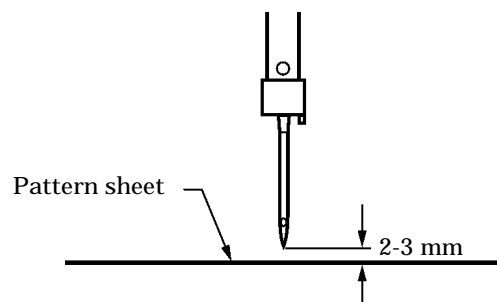

6. Press **P** on the programmer.  
The needle moves to the home position.

## Turning power OFF

1. Write the programmer data into a floppy disk.  
Refer to "Writing data to a floppy disk" (page 216.).  
If the data is not need to be saved, delete it.  
Refer to "Deleting data in a floppy disk" (page 218.).
2. Press **P** on the programmer.  
The panel turns off.
3. Press the foot switch pedal to lift the work clamp.

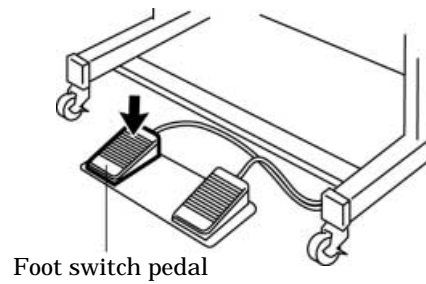

4. Remove the pattern sheet.
5. Press the foot switch pedal to lower the work clamp.
6. Switch OFF the machine.

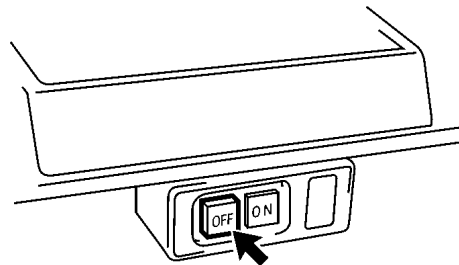

# Handling of floppy disk

Do not force open the shutter for direct contact with the magnetic area.



Do not bring disks near magnetic matters such as magnetic screwdriver or the back side of the programmer.



Do not store floppy disks in an extremely high or low ambient temperature.

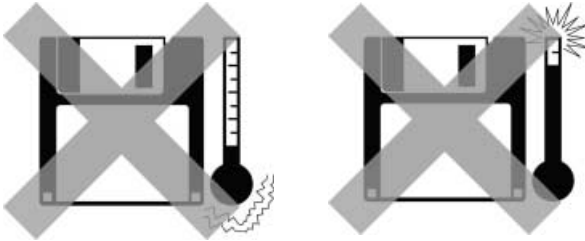

Do not use floppy disks under high humidity.



Do not use or store floppy disks in a dusty place.



Do not store floppy disks under direct sunlight.



Do not bend the disk. Do not put things on the disk.



Avoid contact with solvent or drink.



Do not remove the disk out of the drive during the access lamp is lit.

## Protecting data in floppy disks

Write-protection is available for a floppy disk to prevent undesired data deletion. A write-protected disk is read-only. It is recommended to provide write-protection for disks which contain important data.

To do so, slide the write-protect notch to open the slot as shown below.

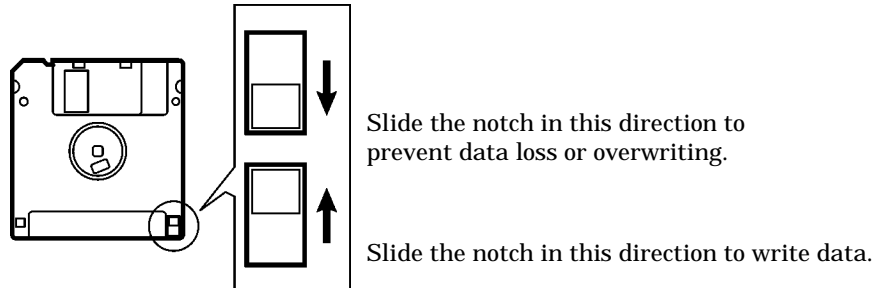

## Setting a Floppy Disk to the Floppy Disk Drive

Insert a floppy disk straight into the slot. The label side of the disk must face the front.

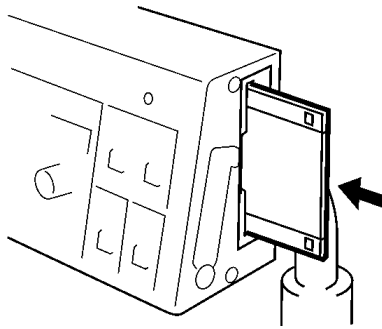

Press the eject switch to remove the disk out of the drive.

Do not press the eject switch during the access lamp is lit. This may lead to data corruption.

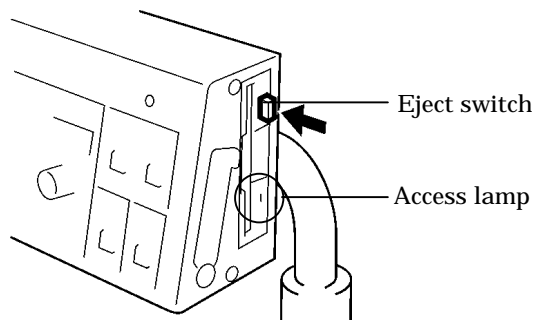

# Contents

---

This manual consists of the following chapters.

- |           |  |
|-----------|--|
| Chapter 1 | Preparations of operation<br>Describes the basic precautions.  |
| Chapter 2 | Programming with Help Function<br>Describes the procedure to create programs using icons.<br>It is recommended for persons<br>who are used to icon input.<br>who use this machine for the first time.<br>who sometimes create programs.          |
| Chapter 3 | Programming with Command Function<br>Describes the procedure to create programs using command functions.<br>It is recommended for persons<br>who is specially responsible for program creation.<br>who have created programs for BAS-300 series. |
| Chapter 4 | Extended Option Output (BAS-300 Series)<br>Describes on setting the extended option output.  |
| Chapter 5 | Reading/Writing Data<br>Describes the procedure to read from/write into floppy disks.  |
| Chapter 6 | Preference<br>Describes the setting procedure of the operation conditions.   |

## Notes for programming

### Pattern sheet

Use thin plotting paper or prepare copies of pattern sheet.  
The pattern sheet is designed in the original scale. Adjust the size to magnification (2, 5, or 10) for magnified input.

### Stitch length

BAS-300 Series    0.3-12.7 mm  
KE-436B, 436C    0.3-10.0 mm

### Stitch count

Maximum available count is 20,000.

### Available types of floppy disk

Data type (*1)	Stitch count for memory	Data resolution	Disk	Format	Write
BAS-300E Data (BAS-300F KE-436B, 436C)	20,000 stitches/ pattern 100 patterns Total: Up to 360,000 stitches	0.05 mm/pulse (*4)	2HD	DOS/V 1.44M	Available
TFD embroidery data (*2) (DST, DSB, DSZ)	50,000 stitches/pattern	0.1 mm/pulse			Not available
Former BAS-300A data	4,000 stitches/pattern 10 patterns Total: Up to 40,000 stitches	0.1 mm/pulse	2DD (*3)	Formatted automatically.	Available
Former BAS-300 data	2,000 stitches/pattern 10 patterns Total: Up to 20,000 stitches	0.2 mm/pulse			Not available

(\*1) As shown in the table, four types of data are available for writing. Data written into 2HD and 2DD disks are automatically converted to BAS-300E and former BAS-300A data respectively.

(\*2) TFD data is converted to BAS-300E data by the programmer and becomes available for sewing.

(\*3) Restrictions for 2DD floppy disks.  
The use of following functions added to the E series are restricted to maintain the compatibility with former BAS-300A data.

(\*4) The machine resolution limit for KE-436B and 436C are 0.1mm/pulse.

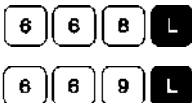
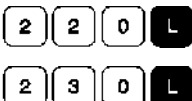
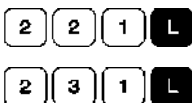
Restricted functions	A Series (2DD)	E, F Series (2HD)	KE Series (2HD)	Commands
Resolution	0.1mm/pulse	0.05mm/pulse	0.1 mm/pulse	
Low-speed sewing	2 options: 400 and 1200 rpm	4 options: 400, 600, 800, 1200 rpm	4 options: 400, 600, 800, 1200 rpm	
Split function in sewing	No	Yes	Yes	
Stoppage of split with the needle at the lower end	No	Yes	Yes	
Extended option output	No	Yes	No	





# Chapter 2

## Programming with Help Function

# Please read before programming

When the lamp on the button  is lit, small pictures appear on the display. These pictures represent different functions. They are called 'icons'. This chapter describes the method of programming with icons.

## Panel description and usage

The following panel keys are used in Help mode.

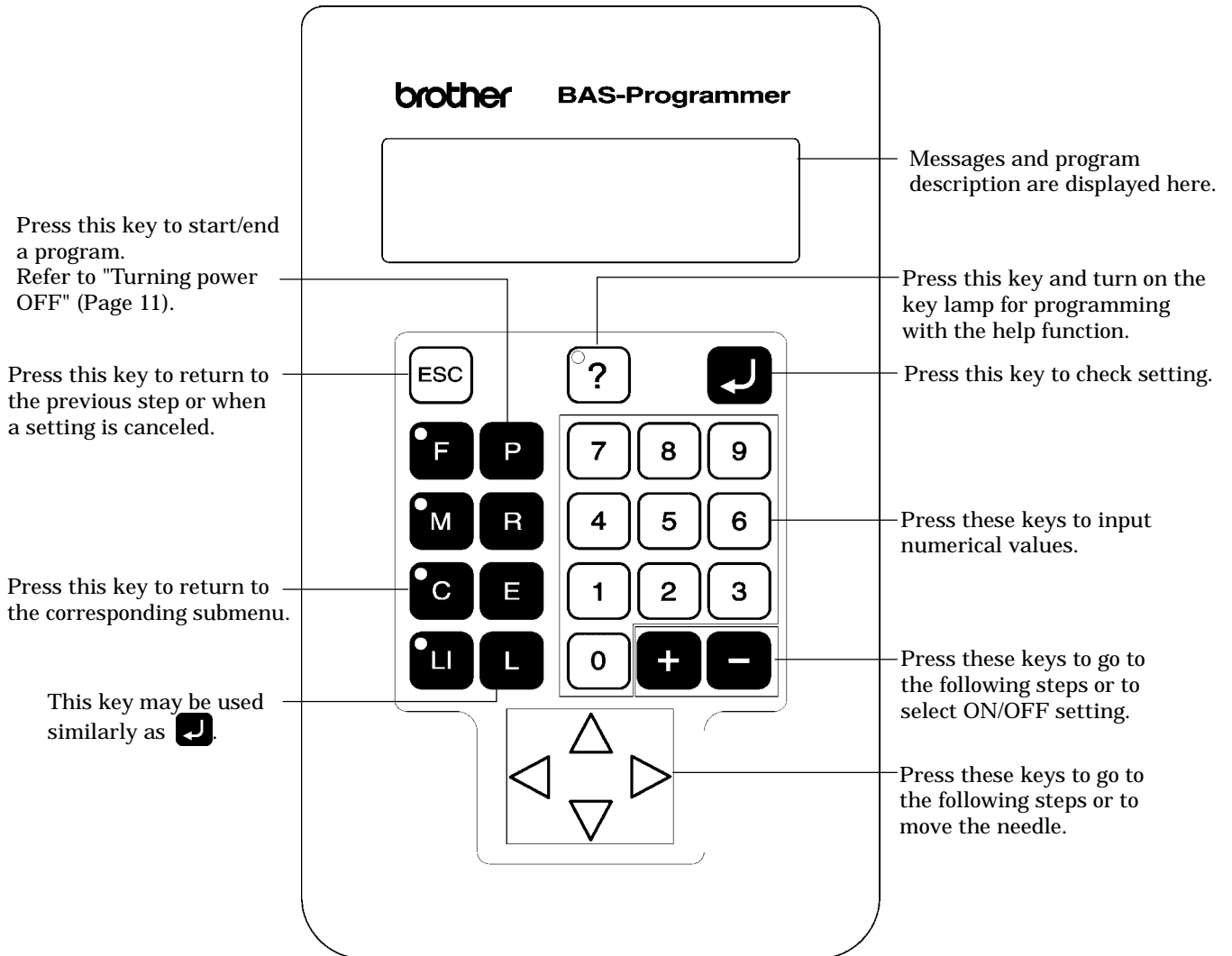

## Display screen

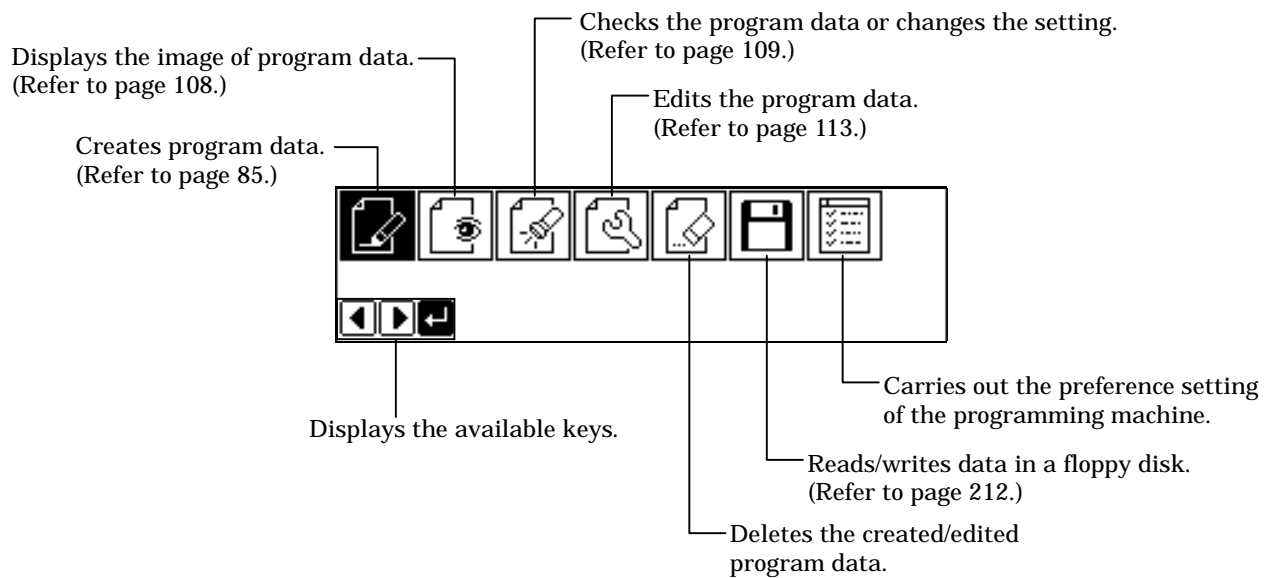

When **P** is pressed, the following screen is displayed.

If the screen is not displayed, press **?**.



# Programming flowchart

## Programming

Select  and press .



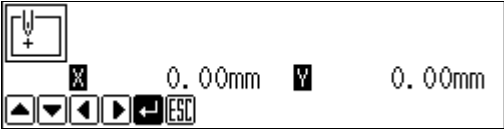

Position the sewing start position and press .

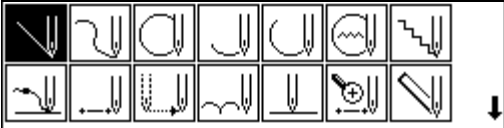

Select an icon for programming. (Refer to page 85.)



Combine straight lines, curves and other figures to make patterns on the pattern sheet. After completing each pattern, press  or  key to return to the submenu.  
The data is available until deletion.  
The program outline may be checked or corrected during editing.



Input end code. (Refer to page 93.)



## Editing program (Refer to page 113.)

Select  and press .



Select an icon for editing.

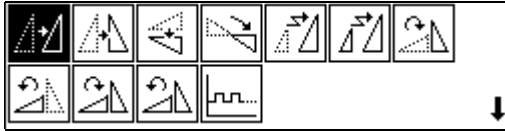

Press  after editing.

## Checking and setting (Refer to page 109.)

Select  and press .



Move to the needle position for setting.



Press  and carry out setting.

## Description of icons

---



### Programming

---



Creating a line

---



Creating a curve

---



Creating a circle



Creating a circle by specifying 3 points on the circumference



Creating a circle of the specified diameter in the clockwise direction



Creating a circle of the specified diameter in the counterclockwise direction



Creating a circle of the specified radius in the clockwise direction



Creating a circle of the specified radius in the counterclockwise direction

---



Creating an arc

---



Creating a semicircle



Creating a semicircle of the specified diameter in the clockwise direction



Creating a semicircle of the specified diameter in the counterclockwise direction

---



Creating a zigzag circle



Creating a zigzag circle by specifying 3 points on the circumference



Creating a zigzag circle of the specified diameter in the clockwise direction



Creating a zigzag circle of the specified diameter in the counterclockwise direction



Creating a zigzag circle of the specified radius in the clockwise direction



Creating a zigzag circle of the specified radius in the counterclockwise direction

---



Carrying out zigzag stitch



Carrying out zigzag stitch on the sewing path



Carrying out zigzag stitch on the left side of the sewing path



Carrying out zigzag stitch on the right side of the sewing path

---



Ending programming



























---



Creating needle drop data

---

---

	Creating feed data
	Creating basting data
	Creating split data
	Creating magnified data
	Inputting data (×2)
	Inputting data (×5)
	Inputting data (×10)
	Carrying out double stitch
	Creating double stitch data in the reverse direction to the left side of the sewing path
	Creating double stitch data in the reverse direction to the right side of the sewing path
	Creating double stitch data in the same direction to the left side of the sewing path
	Creating double stitch data in the same direction to the right side of the sewing path
	Offsetting double stitch data to the left side of the sewing path
	Offsetting double stitch data to the right side of the sewing path
	Displaying the data image during editing
	Checking the program setting and setting attribute
	Editing the current data
	Moving a pattern in parallel by feeding
	Moving a pattern in parallel by sewing with the specified pitch
	Moving a pattern in parallel
	Moving a part of pattern in parallel
	Repeated copying
	Copying a pattern symmetrically to the Y axis
	Copying a pattern symmetrically to the X axis
	Copying a pattern symmetrically to a point
	Copying a pattern turnover

---





Deleting a part of the program

---



Setting low-speed sewing

---



Inputting the trigger (BAS-300 series)

---



Starting a multiple stitch

---



Displaying a pattern image



Checking the program setting and setting attribute



Editing data

---



Moving a pattern in parallel

---



Moving a pattern symmetrically to the Y axis

---



Moving a pattern symmetrically to the X axis

---



Moving a pattern symmetrically to a point

---



Resizing a pattern

---



Copying a resized pattern

---



Rotating a pattern clockwise

---



Copying a pattern rotated clockwise

---



Rotating a pattern counterclockwise

---



Copying a pattern rotated counterclockwise

---



Setting the extended option output (BAS-300 Series)

---



Deleting data

## Programming example

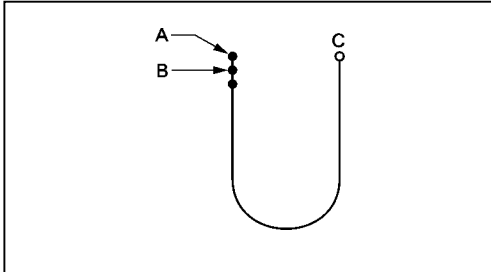

Frequently used programming method is explained here. Refer to "Programming" (page 85) for function and operation of each icon.

### Programming for each stitch



Program each stitch according to the pattern. The example in the left is used for explanation.

### Programming

- Press **P**.  
The work clamp moves to the home position and the programmer screen is displayed.
- Select  with **◀▶** and press **↵**.
- Move the work clamp with **△▽◀▶**. Press **↵** when the needle point is at point A of the pattern.  
The first stitch (point A) is programmed.
- Select  with **△▽◀▶** and press **↵**.
- Move the work clamp with **△▽◀▶**. Press **↵** when the needle point is at point B of the pattern.
- Repeat step 5 and create the program to point C.

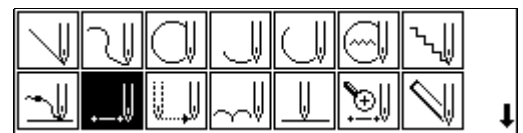
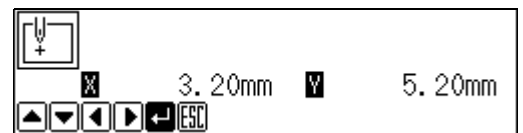

7. When point C is programmed, press **ESC**.

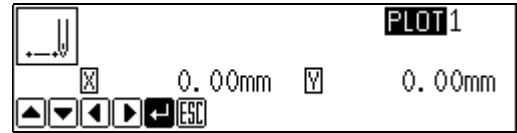

Inputting the end code

1. Select  with **Δ▽◀▶** and press **↵**.

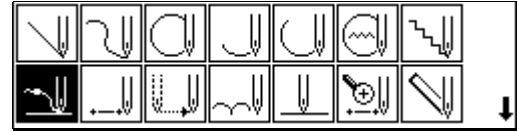

2. Select the end code type with **+** **-** and press **↵**.

"111" is selected in the example. Press **↵** and the work clamp returns to the first stitch(point A).



3. Press **ESC**.

The work clamp returns to the home position.

Saving

1. Select  with **◀▶** and press **↵**.



2. Select  with **◀▶** and press **↵**.



3. Input the data number and press **↵**.



4. Press **ESC**.

Ending program

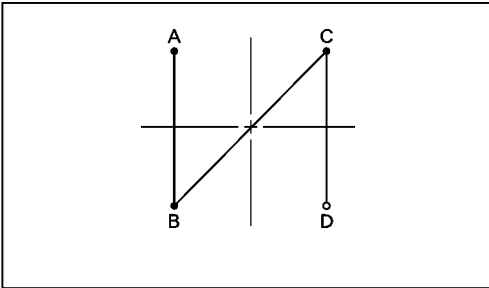

1. Press **P**.

## Magnified input



To program a detailed pattern for each stitch, use a magnified input. The example in the left is used for explanation of programming the pattern to the magnification of 5.

## Programming

- Press **P**.  
The work clamp moves to the home position and the programmer screen is displayed.
- Select  with **◀▶** and press **↵**.
- Move the work clamp with **△▽◀▶**. Press **↵** when the needle point is at point A of the pattern.  
The first stitch (point A) is programmed.
- Select  with **△▽◀▶** and press **↵**.
- Select  and press **↵**.
- Move the work clamp with **△▽◀▶**. Press **↵** when the needle point is at point B of the pattern.
- Repeat step 6 and create the program to point D.
- When point D is programmed, press **ESC** twice.

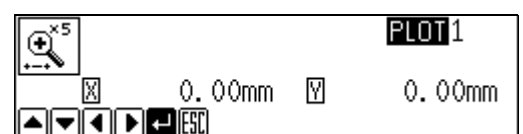
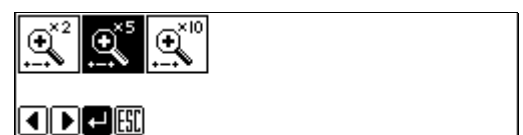
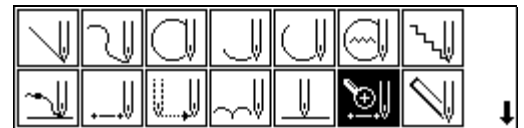

### Inputting the end code

1. Select  with  $\Delta \nabla \triangleleft \triangleright$  and press .

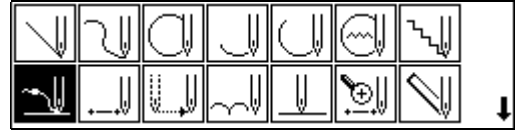



2. Select the end code type with  $+$   $-$  and press .

"111" is selected in the example. Press  and the work clamp returns to the first stitch (point A).



3. Press .  
The work clamp returns to the home position.

### Saving

1. Select  with  $\triangleleft \triangleright$  and press .



2. Select  with  $\triangleleft \triangleright$  and press .



3. Input the data number and press .



4. Press .

### Ending program

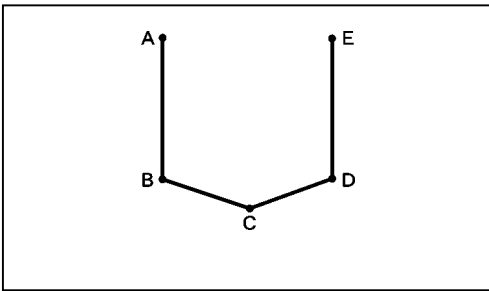

1. Press .

## Lines



The pattern with lines is programmed.  
The example in the left is used for explanation of programming.

## Programming

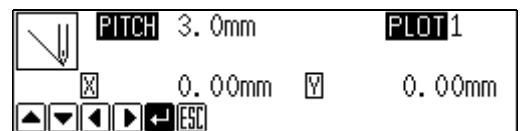
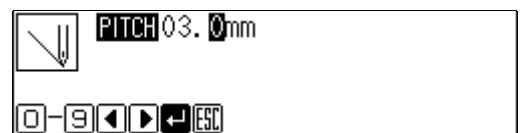
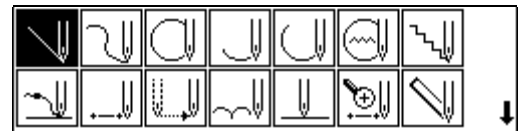
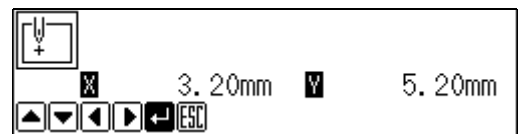

- Press **P**.  
The work clamp moves to the home position and the programmer screen is displayed.
- Select  with **◀▶** and press **↵**.
- Move the work clamp with **△▽◀▶**. Press **↵** when the needle point is at point A of the pattern.  
The first stitch (point A) is programmed.
- Select  with **△▽◀▶** and press **↵**.
- Input the stitch length and press **↵**.  
3.0 mm is input in the example.  
Input 030 to make the stitch length to 3.0 mm.
- Move the work clamp with **△▽◀▶**. Press **↵** when the needle point is at point B of the pattern.
- Repeat step 6 and create the program to point E.
- When point E is programmed, press **ESC** twice.

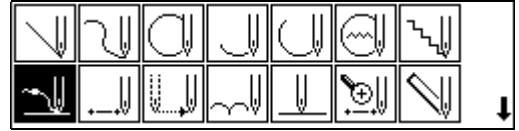

### Inputting the end code

1. Select  with  $\Delta \nabla \triangleleft \triangleright$  and press .





2. Select the end code type with  $+$   $-$  and press .  
"111" is selected in the example. Press  and the work clamp returns to the first stitch (point A).



3. Press .  
The work clamp returns to the home position.

### Saving

1. Select  with  $\triangleleft \triangleright$  and press .



2. Select  with  $\triangleleft \triangleright$  and press .



3. Input the data number and press .



4. Press .

### Ending program

1. Press .

## Curve

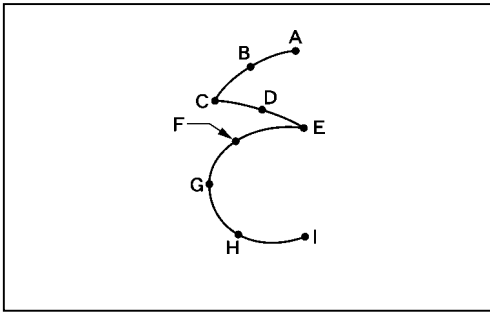

The pattern with curves is programmed. The example in the left is used for explanation of programming at the curve and the corner.

Be sure to press **↵** twice for a split at corner points C or E. If a split is not made, the corner will be round.

When a split is made

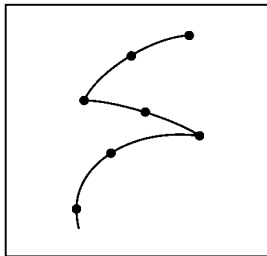

When a split is not made

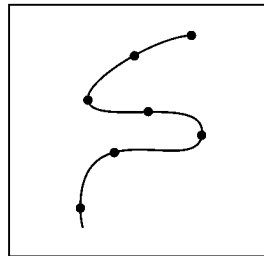

More intermediate points such as points B, D, F or G will create smooth curves.

## Programming

1. Press **P**.  
The work clamp moves to the home position and the programmer screen is displayed.

2. Select  with **◀▶** and press **↵**.



3. Move the work clamp with **△▽◀▶**. Press **↵** when the needle point is at point A of the pattern.  
The first stitch (point A) is programmed.

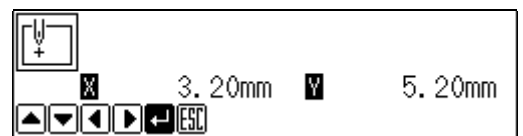

4. Select  with **△▽◀▶** and press **↵**.

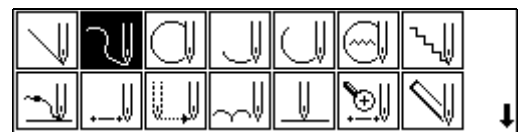



- Input the stitch length and press .  
3.0 mm is input in the example.  
Input 030 to make the stitch length to 3.0 mm.

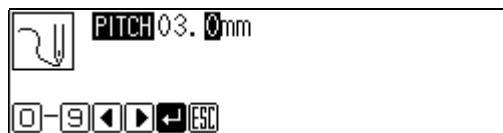

- Move the work clamp with . Press when the needle point is at point B of the pattern.
- Repeat step 6 and create the program to point C.

- When point C is programmed, press again.  
Point C becomes a corner and is programmed. To change the stitch length, press for resetting.

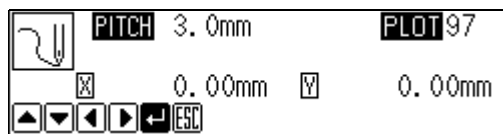

- Create the program to point E.

- When point E is programmed, press again.

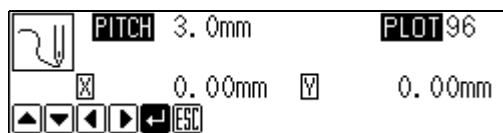

- Create the program to point I.

- When point I is programmed, press again.

- Press twice.

### Inputting the end code

- Select with and press .

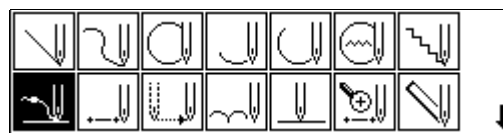



- Select the end code type with and press .  
"111" is selected in the example. Press and the work clamp returns to the first stitch (point A).





- Press .  
The work clamp returns to the home position.

## Saving

1. Select  with   and press .



2. Select  with   and press .



3. Input the data number and press .



4. Press .

## Ending program

1. Press .

## Double stitch

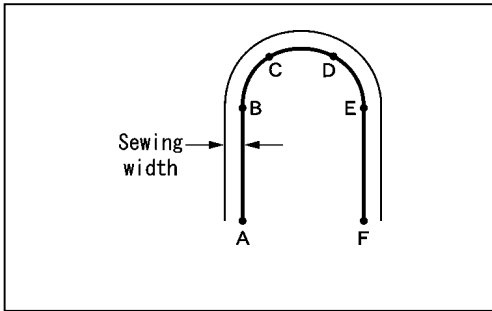

A double stitch is programmed to make two lines with a constant width.  
The example in the left is used for explanation of a double stitch to the left of sewing direction.

When the line changes from straight to curve as in points B or E, be sure to press **↵** twice to make a split.  
More intermediate points such as points C or D will create smooth curves.

### Programming

1. Press **P**.  
The work clamp moves to the home position and the programmer screen is displayed.

2. Select  with **◀▶** and press **↵**.



3. Move the work clamp with **△▽◀▶**. Press **↵** when the needle point is at point A of the pattern.  
The first stitch (point A) is programmed.

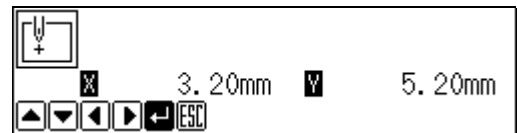

4. Select  with **△▽◀▶** and press **↵**.

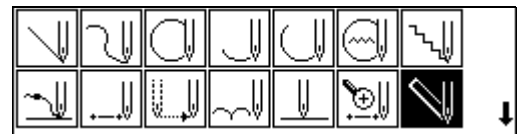

5. Select the double stitch type and press **↵**.

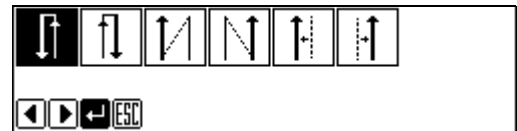

6. Input the stitch length and the width of the double stitch. Press **↵**.  
3.0 mm is input in the example.  
Input 030 to make the stitch length to 3.0 mm.  
To switch input between the stitch length and the width, use **△▽**.



7. Move the work clamp with  $\Delta \nabla \triangleleft \triangleright$ . Press  $\downarrow$  twice when the needle point is at point B of the pattern.
8. Program points C, D and E.
9. When point E is programmed, press  $\downarrow$  again.
10. Program point F.
11. When point F is programmed, press  $\downarrow$  again.
12. Press  $\downarrow$ .  
The needle moves to points F, G and H.

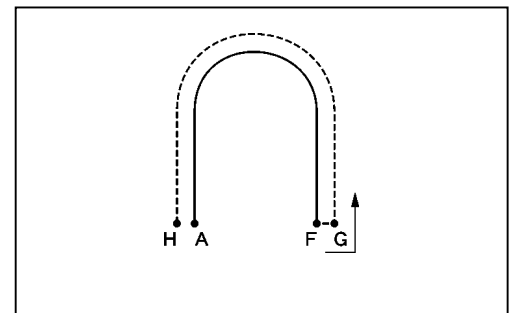
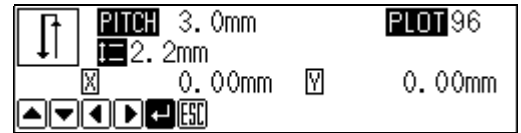

13. When the needle stops, press  $\text{ESC}$  three times.

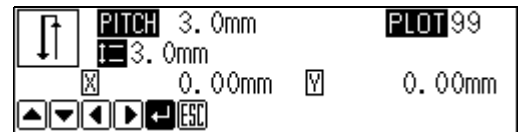

### Inputting the end code

1. Select  with  $\Delta \nabla \triangleleft \triangleright$  and press  $\downarrow$ .
2. Select the end code type with  $+$   $-$  and press  $\downarrow$ .  
"111" is selected in the example. Press  $\downarrow$  and the work clamp returns to the first stitch (point A).
3. Press  $\text{ESC}$ .  
The work clamp returns to the home position.

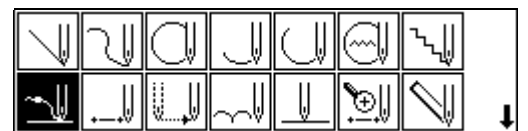

## Saving

1. Select  with  and press .



2. Select  with  and press .



3. Input the data number and press .



4. Press .

## Ending program

1. Press .

## Feed

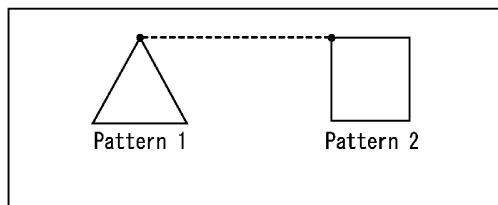

After thread breaking, a feed is set for continuous sewing with the work clamp in position.  
The example in the left is used for explanation of programming pattern 2 with a feed after pattern 1.

## Programming

1. Press .  
The work clamp moves to the home position and the programmer screen is displayed.

2. Select  with  and press .



3. Move the work clamp with  $\Delta \nabla \triangleleft \triangleright$ . Press  $\blacktriangleright$  when the needle point is at point A of the pattern. The first stitch (point A) is programmed.



4. Program pattern 1.

5. Press  $\text{ESC}$  after input of point B.

The number of pressing  $\text{ESC}$  depends on the programming method for pattern 1.

When  $\text{[Needle Icon]}$  is used for programming, press twice. When each stitch is programmed, press once.

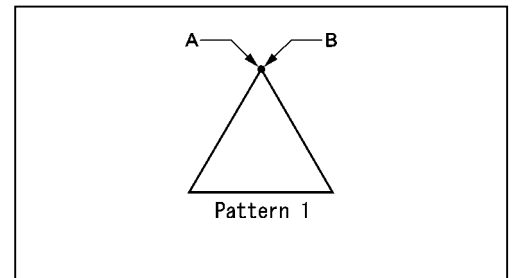

6. Select  $\text{[Needle Icon]}$  with  $\Delta \nabla \triangleleft \triangleright$  and press  $\blacktriangleright$ .

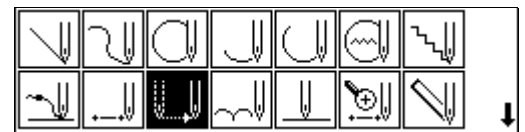

7. Move the work clamp with  $\Delta \nabla \triangleleft \triangleright$ . Press  $\blacktriangleright$  when the needle point is at point C of the pattern.

8. Press  $\text{ESC}$ .

9. Program pattern 2.

10. When point D is programmed, press  $\text{ESC}$ .

The number of pressing  $\text{ESC}$  depends on the programming method for pattern 2.

When  $\text{[Needle Icon]}$  is used for programming, press twice. When each stitch is programmed, press once.

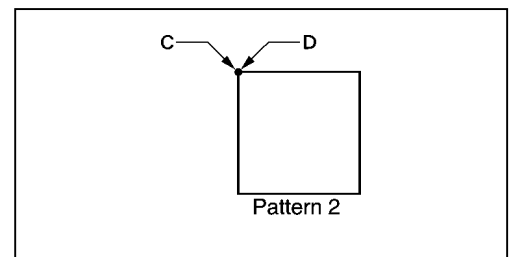

### Inputting the end code

1. Select  $\text{[Needle Icon]}$  with  $\Delta \nabla \triangleleft \triangleright$  and press  $\blacktriangleright$ .

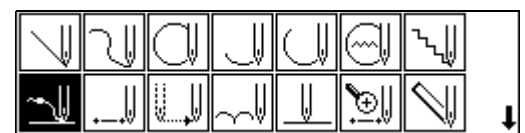

2. Select the end code type with  $\text{+}$   $\text{-}$  and press  $\blacktriangleright$ .

"111" is selected in the example. Press  $\blacktriangleright$  and the work clamp returns to the first stitch (point A).



3. Press  $\text{ESC}$ .

The work clamp returns to the home position.

### Saving

1. Select  with  and press .



2. Select  with  and press .



3. Input the data number and press .



4. Press .

### Ending program

1. Press .

### Basting

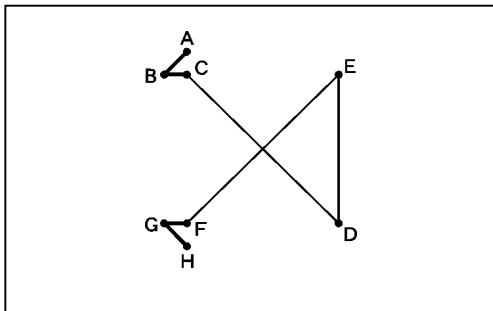

Basting is programmed. The example in the left is used for explanation of basting programming from point C to point F.

### Programming

1. Press .  
The work clamp moves to the home position and the programmer screen is displayed.

2. Select  with  and press .



3. Move the work clamp with  $\Delta \nabla \triangleleft \triangleright$ . Press  $\text{J}$  when the needle point is at point A of the pattern. The first stitch (point A) is programmed.



4. Select  with  $\Delta \nabla \triangleleft \triangleright$  and press  $\text{J}$ .

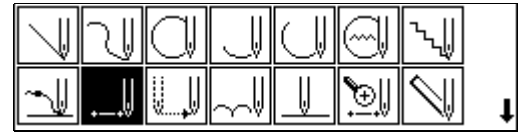

5. Move the work clamp with  $\Delta \nabla \triangleleft \triangleright$ . Press  $\text{J}$  when the needle point is at point B of the pattern.

6. Repeat step 5 and create the program to point C.

7. When point C is programmed, press  $\text{ESC}$ .

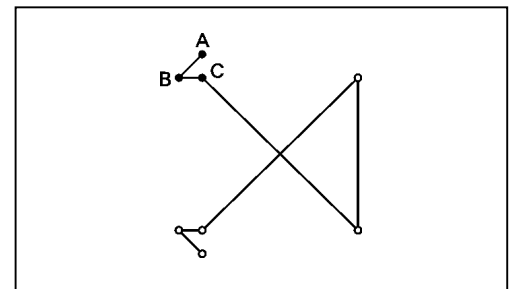

8. Select  with  $\Delta \nabla \triangleleft \triangleright$  and press  $\text{J}$ .

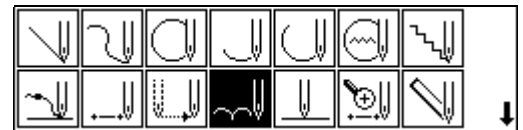

9. Move the work clamp with  $\Delta \nabla \triangleleft \triangleright$ . Press  $\text{J}$  when the needle point is at point D of the pattern.

10. Repeat step 9 and create the program to point F.

11. Press  $\text{ESC}$ .

12. Select  with  $\Delta \nabla \triangleleft \triangleright$  and press  $\text{J}$ .

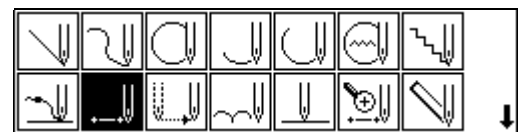

13. Create the program to point H.

14. When point H is programmed, press  $\text{ESC}$ .



### Inputting the end code

1. Select  with  $\Delta \nabla \triangleleft \triangleright$  and press .

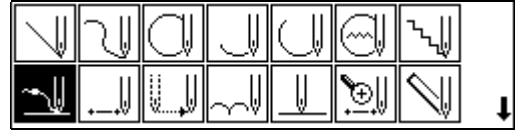

2. Select the end code type with  $+$   $-$  and press .



"111" is selected in the example. Press  and the work clamp returns to the first stitch (point A).



3. Press .

The work clamp returns to the home position.

### Saving

1. Select  with  $\triangleleft \triangleright$  and press .



2. Select  with  $\triangleleft \triangleright$  and press .



3. Input the data number and press .



4. Press .

### Ending program

1. Press .

## Symmetrical pattern

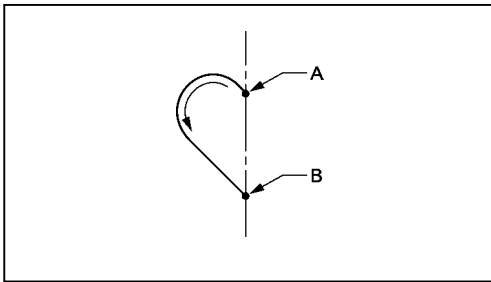

A pattern symmetric to the X axis or the Y axis is programmed. After programming the pattern, select the symmetrical pattern type to complete the pattern. The example in the left is used for explanation of programming symmetric to the Y axis.

The following symmetrical pattern types are available:

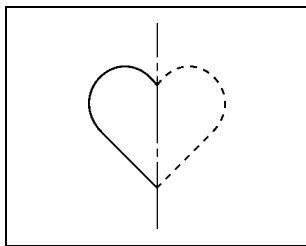

Symmetric to Y axis

Select

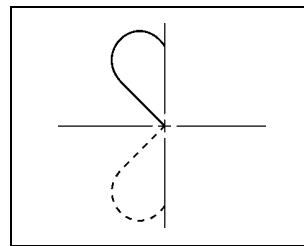

Symmetric to point

Select

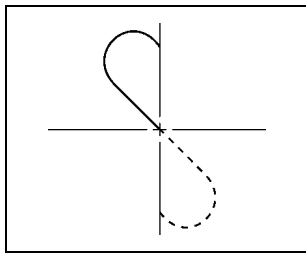

Symmetric to X axis

Select

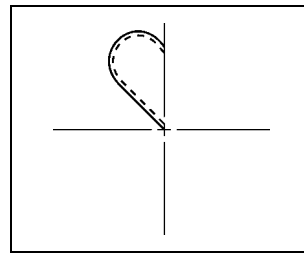

Turnover

Select

## Programming

- Press **P**.  
The work clamp moves to the home position and the programmer screen is displayed.
- Select with **◀▶** and press **↵**.
- Move the work clamp with **△▽◀▶**. Press **↵** when the needle point is at point A of the pattern.  
The first stitch (point A) is programmed.
- Create the program to point B.

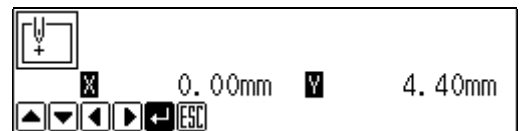

5. When point B is programmed, press **ESC**.

The number of pressing **ESC** depends on the programming method.

### Selecting the symmetrical pattern type

1. Select  with **Δ▽◀▶** and press **↵**.



2. Select the symmetrical pattern type and press **↵**.

 (symmetric to Y axis) is selected in the example.



3. Input the number of feed boundaries to be ignored and press **↵**.

Refer to "Editing the current data" (page 100) for details.



4. The needle point moves slowly from point B to point A in the right half and it is automatically programmed. Press **+** to make fast movement.

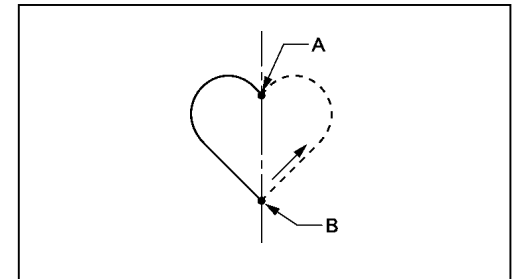

5. Press **ESC** twice.

### Inputting the end code

1. Select  with **Δ▽◀▶** and press **↵**.

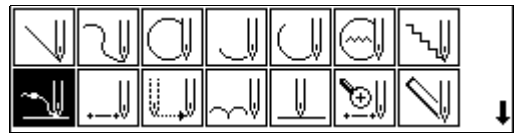

2. Select the end code type with **+** **-** and press **↵**.

"111" is selected in the example. Press **↵** and the work clamp returns to the first stitch (point A).



3. Press **ESC**.

The work clamp returns to the home position.

## Saving

1. Select  with   and press .



2. Select  with   and press .



3. Input the data number and press .



4. Press .

## Ending program

1. Press .

## Splitting

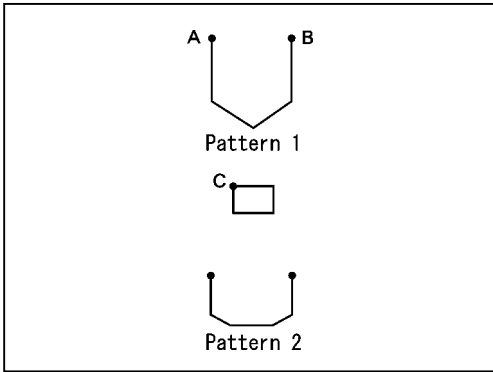

Different patterns, splitting each pattern in sequence, are programmed. The example in the left is used for explanation of 3 patterns in sequence.

## Programming

1. Press **P**.  
The work clamp moves to the home position and the programmer screen is displayed.

2. Select  with **◀▶** and press **↵**.



3. Move the work clamp with **△▽◀▶**. Press **↵** when the needle point is at point A of the pattern.  
The first stitch (point A) is programmed.



4. Program pattern 1.

5. Press **ESC** when the needle point is at point B of the pattern.

The number of pressing **ESC** depends on the programming method for pattern 1.

6. Select  with **△▽◀▶** and press **↵**.

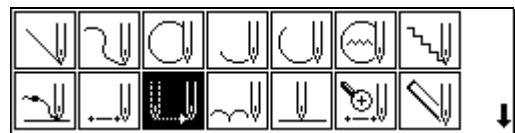

7. Move the work clamp with **△▽◀▶**. Press **↵** when the needle point is at point C of the pattern.

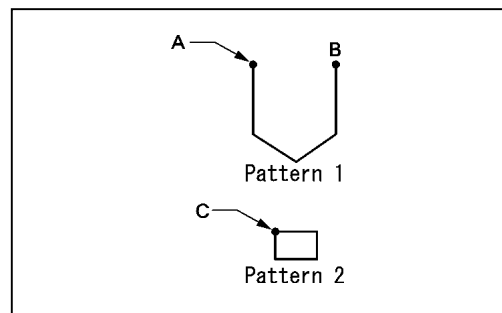

8. Press **ESC**.

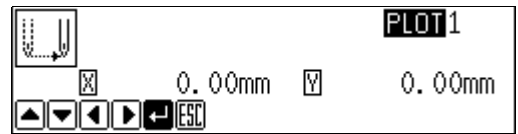

9. Select  with **Δ▽◀▶** and press **↵**.

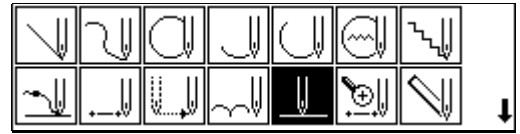

10. Select ON/OFF of needle stopping at the bottom with **+ -** and press **↵**.



11. Program pattern 2.

12. Program pattern 3 in the similar manner.

13. When pattern 3 is programmed, press **ESC**.

### Inputting the end code

1. Select  with **Δ▽◀▶** and press **↵**.

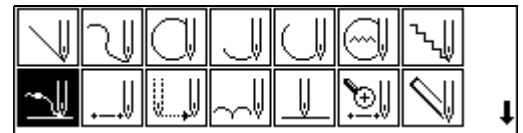

2. Select the end code type with **+ -** and press **↵**.

"111" is selected in the example. Press **↵** and the work clamp returns to the first stitch (point A).



3. Press **ESC**.

The work clamp returns to the home position.

### Saving

1. Select  with **◀▶** and press **↵**.



2. Select  with  and press .



3. Input the data number and press .



4. Press .

### Ending program

1. Press .

### Zigzag stitch

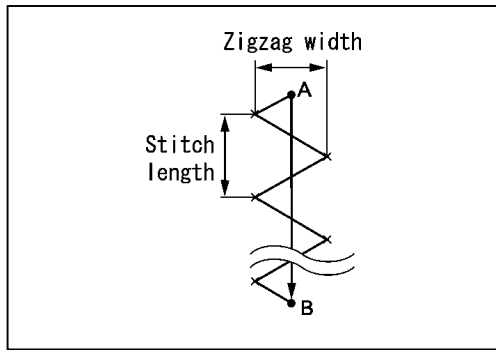

Zigzag stitch is programmed. The example in the left is used for explanation of even width of zigzag stitch on the sewing path.





Zigzag with curves may be programmed.

### Programming

1. Press .  
The work clamp moves to the home position and the programmer screen is displayed.

2. Select  with  and press .



3. Move the work clamp with . Press  when the needle point is at point A of the pattern.  
The first stitch (point A) is programmed.

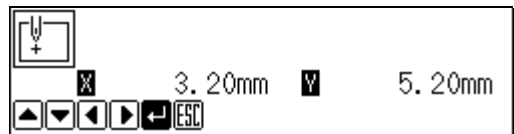

4. Select  with  $\Delta \nabla \triangleleft \triangleright$  and press .

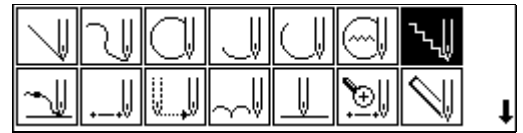

5. Select  with  $\triangleleft \triangleright$  and press .

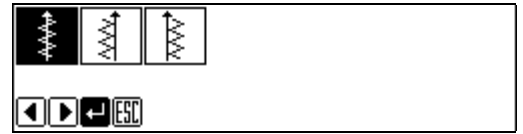

6. Input the zigzag width and the stitch length and press .

3.0 mm is input in the example.

Input 030 to make the width and the stitch length to 3.0 mm.

To switch input between the stitch length and the width, use  $\triangleleft \triangleright$ .



7. Move the work clamp with  $\Delta \nabla \triangleleft \triangleright$ . Press  when the needle point is at point B of the pattern.

To program curves, repeat this step.

8. Press  again.

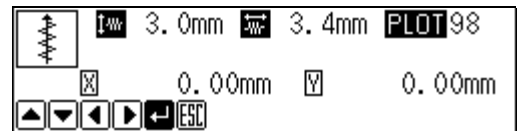



9. Press  three times.

### Inputting the end code

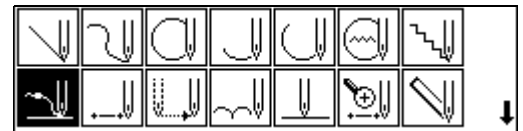
1. Select  with  $\Delta \nabla \triangleleft \triangleright$  and press .



2. Select the end code type with  $+$   $-$  and press .

"111" is selected in the example. Press  and the work clamp returns to the first stitch (point A).

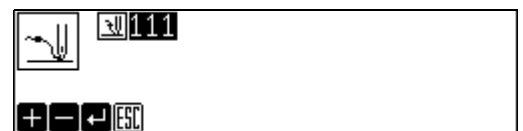



3. Press .

The work clamp returns to the home position.



### Saving

1. Select  with  and press .



2. Select  with  and press .



3. Input the data number and press .



4. Press .

### Ending program

1. Press .

### Multiple stitch

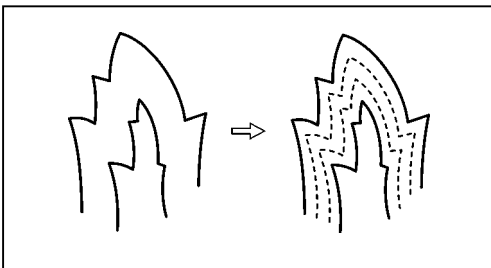

This section describes programming of a multiple stitch. Refer to the example on the left.

Programming can be started from either inside or outside line. Embroidering is carried out in the sequence of programming.

Embroidering direction depends on programming sequence.

When embroidering direction should be changed at a sharp angle, a split should be provided in the vicinity of the direction change point for finishing the multiple stitch in relatively uniform conditions.

Up to 200 points can be specified for one side. If you attempt to input 201 or more points, the needle point is automatically returned to the previous points. In that case, start inputting points of the outside (or the inside) line, or reconsider point input positions or pattern.

## Creating a stitch pattern



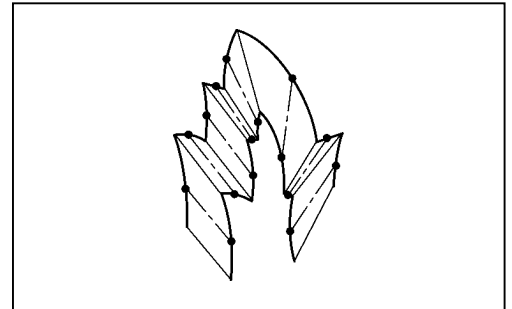
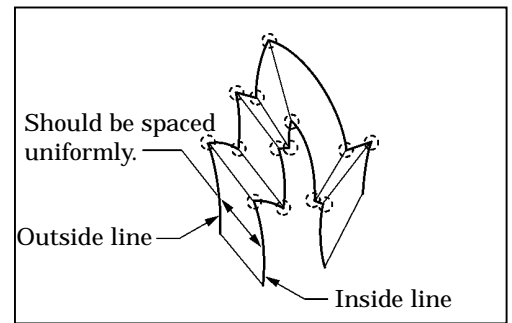



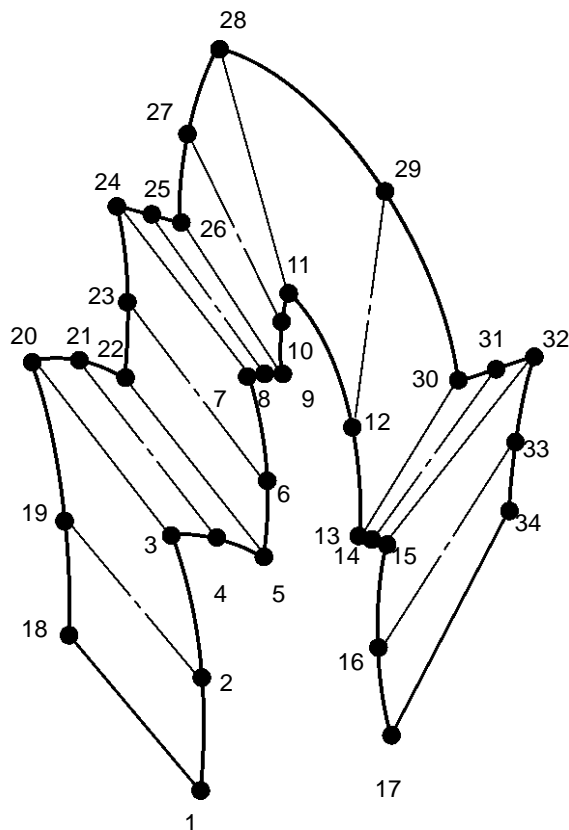

1. Create a pattern in consideration of the most inside and outside lines for a multiple stitch.  
The two lines should be spaced uniformly.
2. Connect each direction change point on the inside line with the matched direction change point on the outside line using a line.
3. Provide one point (or more points) between the above two direction change points, and connect them using a line.  
Follow the procedure for curve points specification. Specify points in pairs on the inside and outside lines. The lines should be spaced uniformly.











## Programming











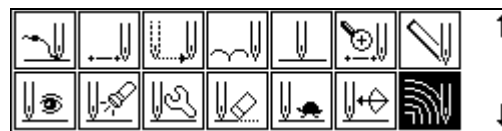

1. Press **P**.  
The work clamp moves to the home position and the programmer screen is displayed.

- Select  with   and press .
- Move the work clamp with    . Press  when the needle point is at point 1 of the pattern.  
The first stitch (point 1) is programmed.



- Select  with     and press .
- Input the stitch length and the number of lines for a multiple stitch. Press .  
"2.0 mm" is input for a stitch length in the example.  
Input "030" to make the stitch length to 3.0 mm.  
To switch input between the stitch length and the number of lines, use  .



- Move the work clamp with    . Press  when the needle point is at point 2 of the pattern.
- Move the work clamp with    . Press  when the needle point is at point 3 of the pattern.







Be sure to press  twice for a split at a corner like point 3. If a split is not made, the corner will be round.



- Program the following points up to point 17 with the curve programming steps.







When there is a liner section, move the needle point from the split to the next split, and press  twice.

In the example, a linear line is programmed between points 7 and 9. Be sure to program a linear line also for the matched section between points 24 and 26.

By pressing  , the needle point is returned to the previous point. It cannot be returned beyond the previous split.

By pressing  , the needle point is returned to the previous split. However, when the needle point is at a split, it cannot be moved.

By pressing  , the needle point is returned to the split before the previous split.

- Press . Move the work clamp with    . Press  when the needle point is at point 18 of the pattern.

10. Program the following points up to point 34 in the same manner.

When programming, be sure that the points and splits specified on the inside line are paired with those on the outside line respectively.

If there are any points or splits not paired, the needle point automatically returns to the previous point. Correct the program.



11. Press .

12. Press .

### Inputting the end code

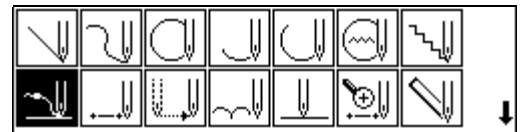
1. Select  with   and press .



2. Select the end code type with   and press .

"111" is selected in the example. Press  and the work clamp returns to the first stitch (point A).



3. Press .

The work clamp returns to the home position.

### Saving

1. Select  with   and press .



2. Select  with   and press .



3. Input the data number and press .



4. Press .

### Ending program

1. Press .

## Example of modified program

This section describes the modification method of the program using examples. Refer to "Programming" (page 85) or "Checking the program setting and setting attribute" (page 109) for function and operation of each icon.

### Resizing pattern

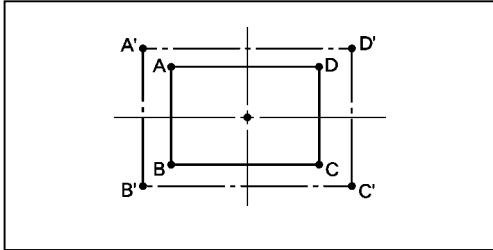

The programmed pattern is resized. The example in the left is used for explanation.

The center point (reference point) of resizing can be changed. The magnifying direction varies depending on the position of the reference point.

If the reference point is not determined, the pattern is resized to the home position.

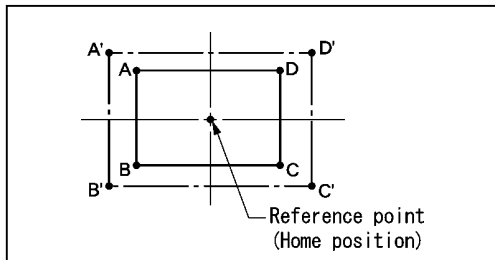

If the reference point is determined, the pattern is resized to the reference point.

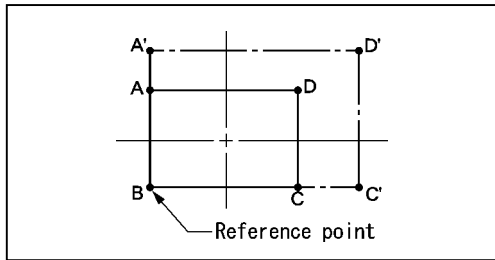

### Calling data

1. Press **P**.  
The work clamp moves to the home position. The programmer screen is displayed.

2. Select  with   and press .



3. Select  with   and press .



4. Input the data number and press .



5. Press .

## Resizing

1. Select  with   and press .



2. Select  with     and press .



3. Input the resizing percentage for the X and the Y axes.

150% is input in the example.





To magnify the pattern by 150%, input 150.

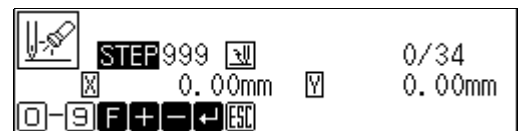

4. Input the stitch length and press .

If the stitch length is 0.0, the pattern is resized with the same number of stitches as the original data.



5. Move the needle to the reference point of resizing with    .

If the needle is not moved, the pattern is resized to the home position.

6. Press .

Calculation is made. The pattern is resized.

### Saving

1. Select  with  and press .



2. Select  with  and press .



3. Input the data number and press .



4. Press .

### Ending program

1. Press .



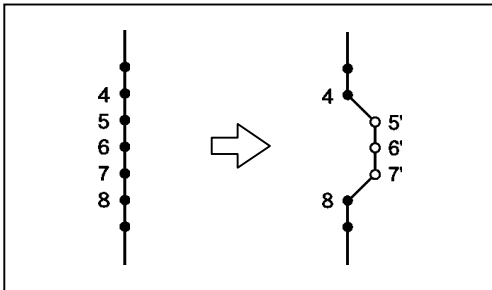

### Changing partially





A part of the programmed pattern is changed. The example in the left is used for explanation of creating 5', 6' and 7'.

### Calling data

1. Press .  
The work clamp moves to the home position. The programmer screen is displayed.

2. Select  with   and press .



3. Select  with   and press .



4. Input the data number and press .







5. Press .

#### Moving to position 4.

1. Select  with   and press .



2. Press    and press .
- The work clamp moves from the start position by each stitch.

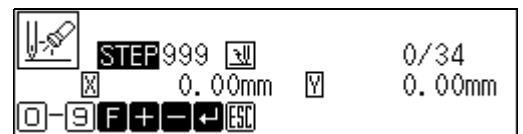

3. When the needle point reaches 4, press .





The work clamp stops. If the work clamp passes, input a few stitches and press . The needle returns for a few stitches of the input.

4. Press .

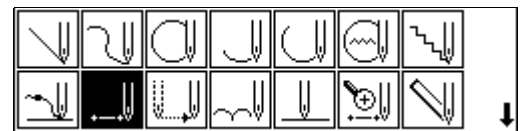
#### Programming a new point.

1. Select  with     and press .



2. Move the work clamp with    . Press  when the needle point is at 5'.



3. Repeat step 2 and program 6' and 7'.

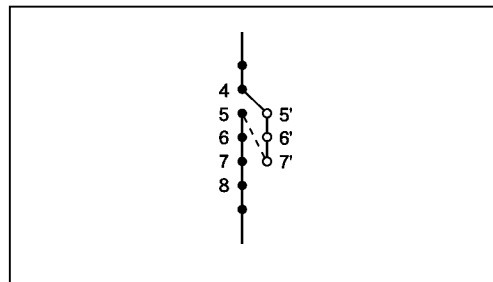

4. Press **ESC**.

5. Select  with **Δ▽◀▶** and press **↵**.

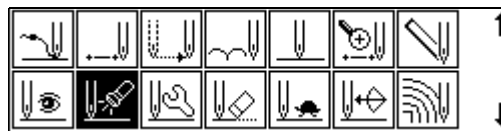

6. Press **1** and press **+**.  
The needle point moves to 5.

7. Press **ESC**.

### Deleting unnecessary points

1. Select  with **Δ▽◀▶** and press **↵**.

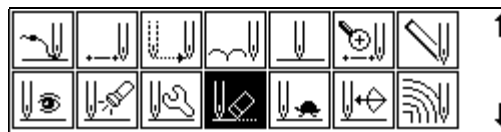



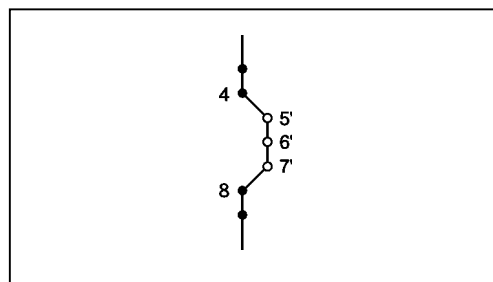

2. Input the number of stitches to be deleted and press **+**.  
The example is deleting 3 stitches ahead. Press **3** **+**.

3. The needle point moves to 6, 7 and 8. Points 5, 6 and 7 are deleted.

4. Press **ESC** twice.



## Saving

1. Select  with   and press .



2. Select  with   and press .



3. Input the data number and press .



4. Press .

## Ending program

1. Press .

## Deleting the first stitch

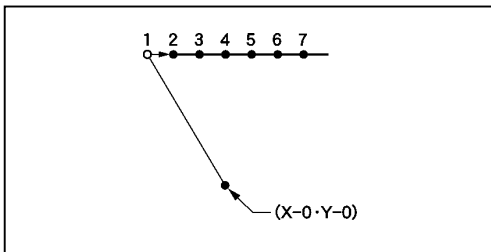

The first stitch of the programmed pattern is deleted. The example in the left is used for explanation of deleting 1 and setting 2 for the sewing start position.

## Calling data

1. Press .  
The work clamp moves to the home position. The programmer screen is displayed.

2. Select  with   and press .



3. Select  with   and press .



4. Input the data number and press .





5. Press .

### Moving to position 1

1. Select  with   and press .







2. Press  and press .  
The work clamp moves to the sewing start position.

3. Press .

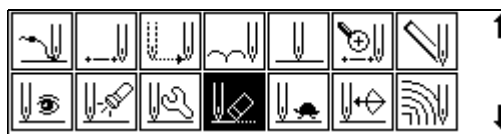
### Deleting 1

1. Select  with     and press .



2. Input the number of stitches to be deleted and press .  
The example is deleting 1 stitch. Press  .

3. The needle point moves to 2.

4. Press  twice.

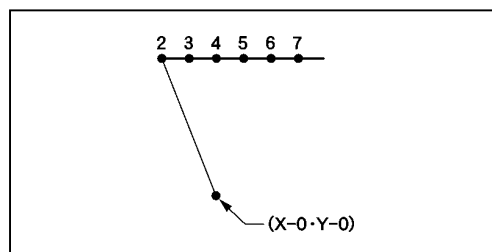

## Saving

1. Select  with   and press .



2. Select  with   and press .



3. Input the data number and press .



4. Press .

## Ending program

1. Press .

## Changing the first stitch position

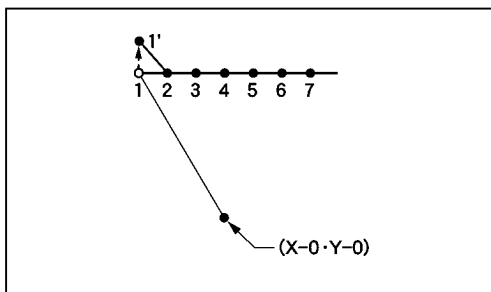

The position of the sewing start position is changed. The example in the left is used for explanation of moving the sewing start position from 1 to 1'.

## Calling data

1. Press .  
The work clamp moves to the home position. The programmer screen is displayed.

2. Select  with   and press .



3. Select  with  $\triangleleft \triangleright$  and press  $\blacktriangledown$ .

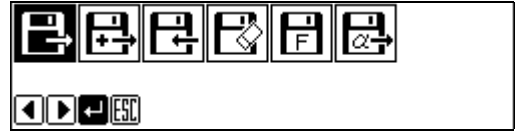

4. Input the data number and press  $\blacktriangledown$ .

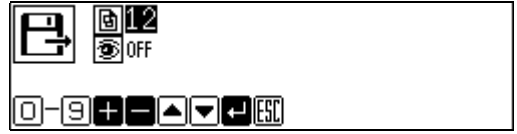

5. Press  $\text{ESC}$ .

### Moving to position 1

1. Select  with  $\triangleleft \triangleright$  and press  $\blacktriangledown$ .



2. Press  $\text{1}$  and press  $\text{+}$ .  
The work clamp moves to the sewing start position.

3. Press  $\text{ESC}$ .

### Programming a new point

1. Select  with  $\triangle \nabla \triangleleft \triangleright$  and press  $\blacktriangledown$ .



2. Move the work clamp with  $\triangle \nabla \triangleleft \triangleright$ . Press  $\blacktriangledown$  when the needle point is at 1'.  
1' is programmed.

3. Press  $\text{ESC}$ .

### Deleting 1

1. Select  with  $\triangle \nabla \triangleleft \triangleright$  and press  $\blacktriangledown$ .

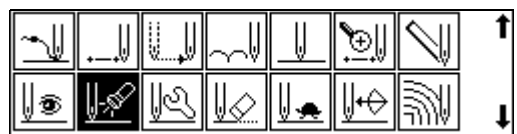

2. Press  $\text{1}$  and press  $\text{-}$ .  
The work clamp moves to the sewing start position.

3. Press **ESC**.
4. Select  with **Δ▽◀▶** and press **↵**.
5. Input the number of stitches to be deleted and press **+**.  
The example is deleting 1 stitch. Press **1** **+**.

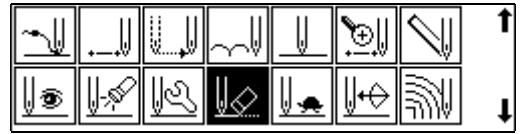

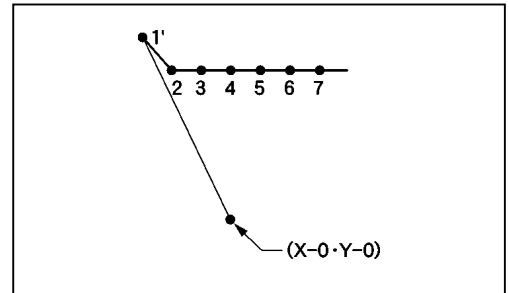

6. The needle point moves to 1'.



7. Press **ESC** twice.

### Saving

1. Select  with **◀▶** and press **↵**.
2. Select  with **◀▶** and press **↵**.
3. Input the data number and press **↵**.
4. Press **ESC**.



### Ending program

1. Press **P**.

## Adding sewing point before the first stitch

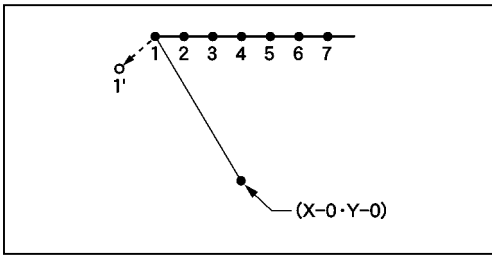

A point is added before the current sewing point to change the sewing start position. The example in the left is used for explanation of changing the sewing start position from 1 to 1'.

### Calling data

1. Press **P**.  
The work clamp moves to the home position. The programmer screen is displayed.

2. Select  with **◀▶** and press **↵**.



3. Select  with **◀▶** and press **↵**.



4. Input the data number and press **↵**.



5. Press **ESC**.

### Moving to position 1





1. Select  with **◀▶** and press **↵**.



2. Press **1** and press **+**.  
The work clamp moves to the sewing start position.







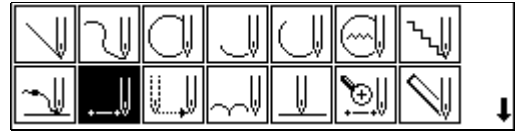



3. Press **ESC**.

## Programming a new point

1. Select  with  $\Delta \nabla \triangleleft \triangleright$  and press .
2. Move the work clamp with  $\Delta \nabla \triangleleft \triangleright$  so that the needle point is at 1'.  
Record the coordinates (values of X and Y).
3. Press .  
1' is programmed.
4. Move the work clamp with  $\Delta \nabla \triangleleft \triangleright$  to the opposite position of coordinates recorded in step 2 so that the needle point is at 1 of the pattern.
5. Press .  
1 is programmed again.
6. Press .



## Deleting 1

1. Select  with  $\Delta \nabla \triangleleft \triangleright$  and press .
2. Press  and press .  
The work clamp moves to the sewing start position.
3. Press .
4. Select  with  $\Delta \nabla \triangleleft \triangleright$  and press .
5. Input the number of stitches to be deleted and press .  
The example is deleting 1 stitch. Press  .

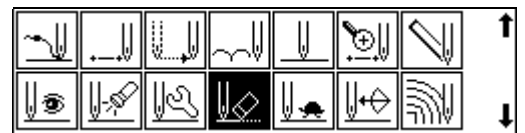
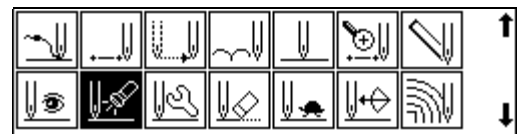



6. The needle point moves to 1'.

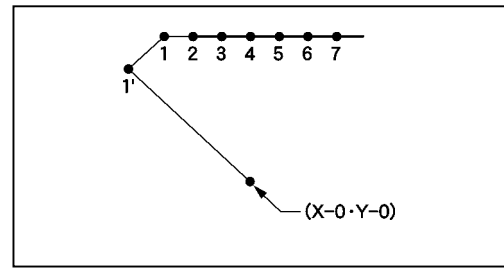

7. Press **ESC** twice.

### Saving

1. Select  with **◀▶** and press **↵**.



2. Select  with **◀▶** and press **↵**.



3. Input the data number and press **↵**.



4. Press **ESC**.

### Ending program

1. Press **P**.

## Adding escape point before the first stitch

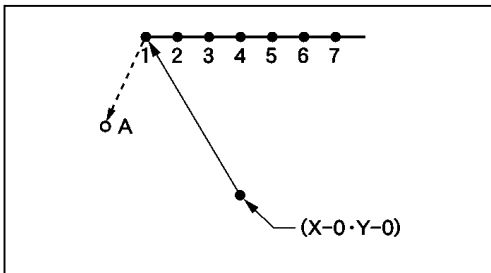

An escape point is added before the sewing start position. The example in the left is used for explanation of setting escape point A.

The escape point is a provisional point provided for prevention of the work clamp interference with the needle or the bar leg when the work clamp is lifted at the start point.

## Calling data

1. Press **P**.  
The work clamp moves to the home position. The programmer screen is displayed.

2. Select  with   and press .



3. Select  with   and press .



4. Input the data number and press .

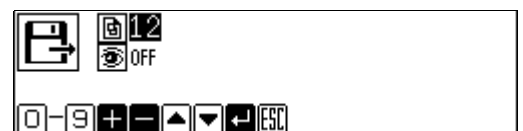



5. Press .

## Moving to position 1





1. Select  with   and press .



2. Press  and press .
- The work clamp moves to the sewing start position.







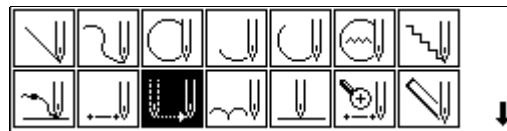



3. Press .

## Programming a new point

1. Select  with  $\Delta \nabla \triangleleft \triangleright$  and press .
2. Move the work clamp with  $\Delta \nabla \triangleleft \triangleright$  so that the needle point is at A of the pattern.  
Record the coordinates (values of X and Y).
3. Press .  
A is programmed.
4. Move the work clamp with  $\Delta \nabla \triangleleft \triangleright$  to the opposite position of coordinates recorded in step 2 so that the needle point is at 1 of the pattern.
5. Press .
6. Press .



## Deleting 1

1. Select  with  $\Delta \nabla \triangleleft \triangleright$  and press .
  2. Press  and press .
  3. Press .
  4. Select  with  $\Delta \nabla \triangleleft \triangleright$  and press .
  5. Input the number of stitches to be deleted and press .
- The example is deleting 1 stitch. Press  .

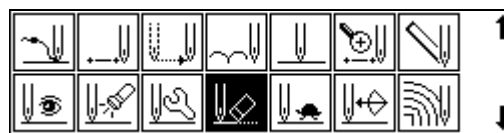
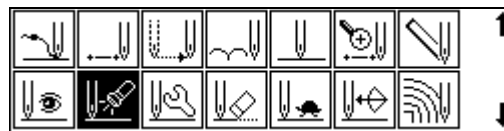

6. The needle point moves to A.

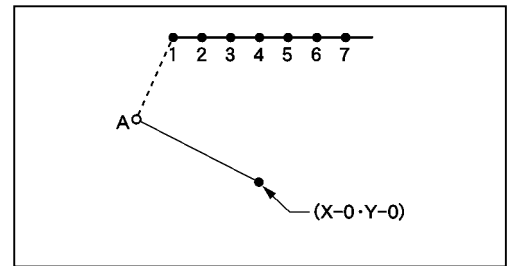

7. Press **ESC** twice.

### Saving

1. Select  with **◀▶** and press **↵**.



2. Select  with **◀▶** and press **↵**.



3. Input the data number and press **↵**.



4. Press **ESC**.

### Ending program

1. Press **P**.



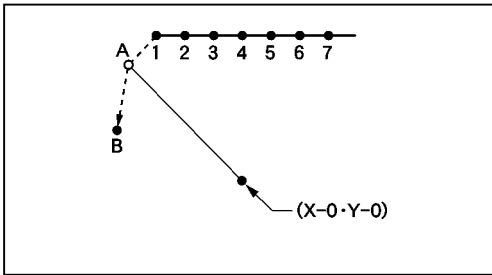

## Moving the escape point



The position of the escape point is moved. The example in the left is used for explanation of moving the escape point from A to B.

## Calling data

1. Press **P**.  
The work clamp moves to the home position. The programmer screen is displayed.

2. Select  with   and press .



3. Select  with   and press .







4. Input the data number and press .





5. Press .

## Moving to position 1





1. Select  with   and press .



2. Press  and press .
- The work clamp moves to the sewing start position.











3. Press .

## Programming a new point





1. Select  with  $\Delta \nabla \triangleleft \triangleright$  and press .
2. Move the work clamp with  $\Delta \nabla \triangleleft \triangleright$ . Press  when the needle point is at B. B is programmed.
3. Press .

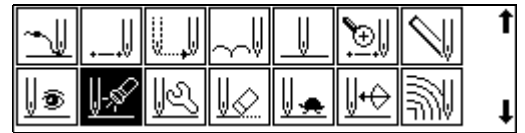

## Deleting 1

1. Select  with  $\Delta \nabla \triangleleft \triangleright$  and press .
2. Press  and press . The work clamp moves to the sewing start position.
3. Press .
4. Select  with  $\Delta \nabla \triangleleft \triangleright$  and press .
5. Input the number of stitches to be deleted and press . The example is deleting 1 stitch. Press  .



4. Select  with  $\Delta \nabla \triangleleft \triangleright$  and press .
5. Input the number of stitches to be deleted and press . The example is deleting 1 stitch. Press  .

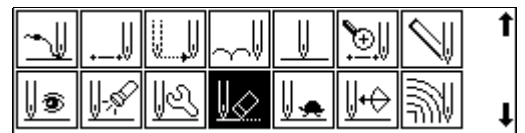

6. The needle point moves to B.

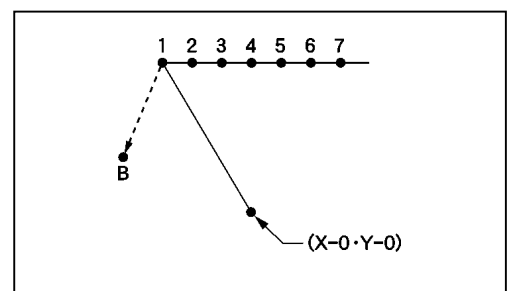

7. Press  twice.

### Saving

1. Select  with   and press .



2. Select  with   and press .



3. Input the data number and press .



4. Press .

### Ending program

1. Press .

### Deleting the escape point

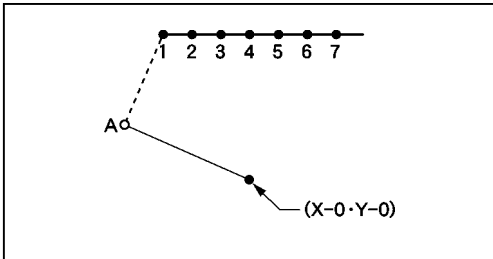

The escape point is deleted. The example in the left is used for explanation of deleting A.

### Calling data

1. Press .

The work clamp moves to the home position. The programmer screen is displayed.

2. Select  with   and press .



3. Select  with  and press .





4. Input the data number and press .





5. Press .

### Moving to position A

1. Select  with  and press .





2. Press  and press .
- The work clamp moves to the sewing start position.

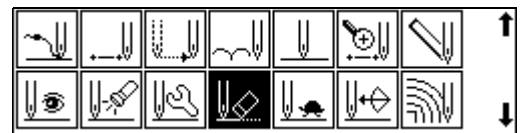

3. Press .

### Deleting A

1. Select  with  and press .



2. Input the number of stitches to be deleted and press .

The example is deleting 1 stitch. Press  .

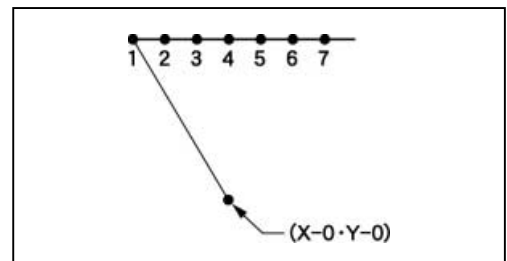

3. The needle point moves to 1.



7. Press  twice.



### Saving

1. Select  with  and press .



2. Select  with  and press .



3. Input the data number and press .



4. Press .

### Ending program

1. Press .

### Moving the pattern in parallel 1

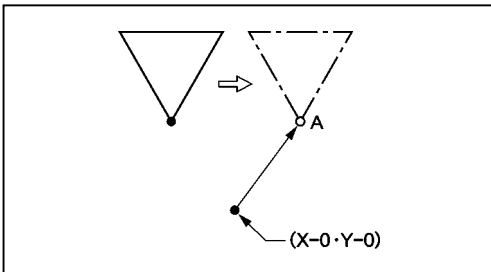

The program data is moved in parallel. The example in the left is used for explanation of moving the pattern in parallel when the first stitch is the sewing start position.

### Calling data

1. Press .  
The work clamp moves to the home position. The programmer screen is displayed.

2. Select  with  and press .



3. Select  with  and press .





4. Input the data number and press .



5. Press .



## Moving

1. Select  with  and press .



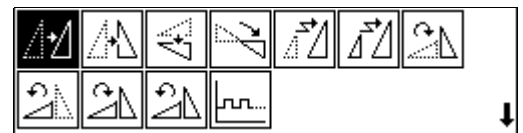

2. Select  with  and press .



3. Move the work clamp with . Press  when the needle point is at point A of the pattern.

4. Press .

## Saving

1. Select  with  and press .



2. Select  with  and press .



3. Input the data number and press .



4. Press .

## Ending program

1. Press **P**.

## Moving the pattern in parallel 2

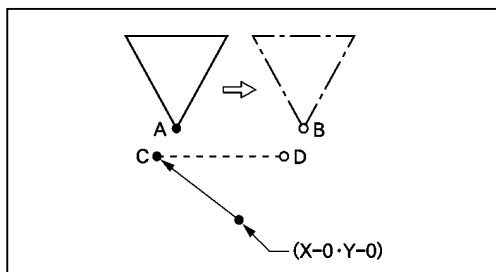

The program data is moved in parallel. The example in the left is used for explanation of moving the pattern in parallel when the first stitch is the escape point.

## Calling data

1. Press **P**.  
The work clamp moves to the home position. The programmer screen is displayed.

2. Select  with **◀▶** and press **↵**.



3. Select  with **◀▶** and press **↵**.



4. Input the data number and press **↵**.



5. Press **ESC**.

## Moving

1. Select  with **◀▶** and press **↵**.



2. Press  $\square$  and press  $\oplus$ .  
The work clamp moves to point A.

3. Press  $\square$  (ESC).

4. Select  with  $\Delta \nabla \triangleleft \triangleright$  and press  $\square$  (Enter).

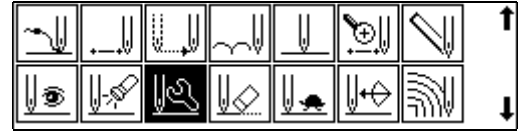

5. Select  with  $\Delta \nabla \triangleleft \triangleright$  and press  $\square$  (Enter).



6. Move the work clamp with  $\Delta \nabla \triangleleft \triangleright$  so that the needle point is at point B of the pattern.  
Record the coordinates (values of X and Y). Do not press  $\square$  (Enter).

7. Press  $\square$  (ESC) three times.  
The needle point returns to the home position.

8. Select  with  $\triangleleft \triangleright$  and press  $\square$  (Enter).



9. Press  $\square$  (1) and press  $\oplus$ .  
The work clamp moves to point C.

10. Press  $\square$  (ESC).

11. Select  with  $\Delta \nabla \triangleleft \triangleright$  and press  $\square$  (Enter).

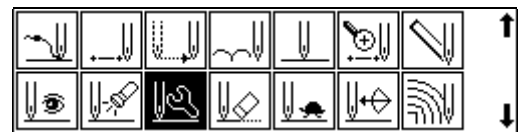

12. Select  with  $\Delta \nabla \triangleleft \triangleright$  and press  $\square$  (Enter).

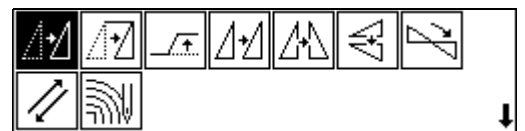

13. Move the work clamp with  $\Delta \nabla \triangleleft \triangleright$  for the coordinates recorded in step 6.

14. Turn the pulley with a hand and put a marking with the needle to indicate the position of point D.

15. Turn the pulley with a hand and move the needle to the top point.

16. Press **ESC** three times.

17. Select  with **◀▶** and press **↵**.



18. Select  with **Δ▽◀▶** and press **↵**.

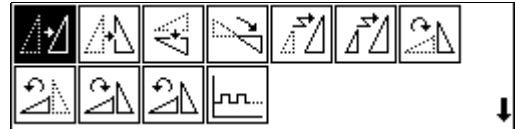

19. Move the work clamp with **Δ▽◀▶**. Press **↵** when the needle point is at point D.

20. Press **ESC**.

### Saving

1. Select  with **◀▶** and press **↵**.

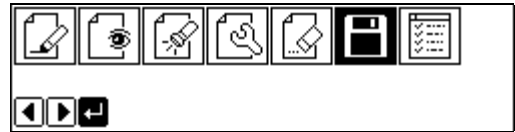

2. Select  with **◀▶** and press **↵**.



3. Input the data number and press **↵**.



4. Press **ESC**.

### Ending program

1. Press **P**.

## Deleting a part of the program during programming

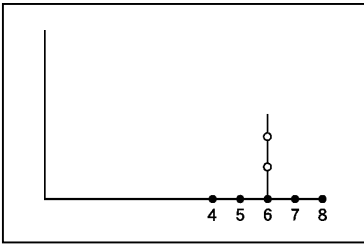

A program can be modified during programming. The example in the left is used for explanation of deleting 2 stitches at 8 and creating a new program.

1. Press **ESC** to display the screen in the right.

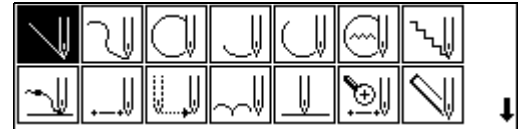

2. Select  with **△▽◀▶** and press **↵**.

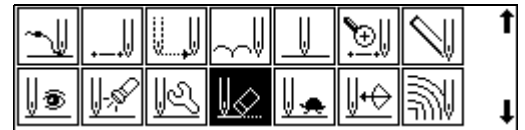

3. Input the number of stitches to be deleted and press **↵**.  
The example is deleting 2 stitches backward. Press **2** **↵**.

4. The needle point moves to 6.

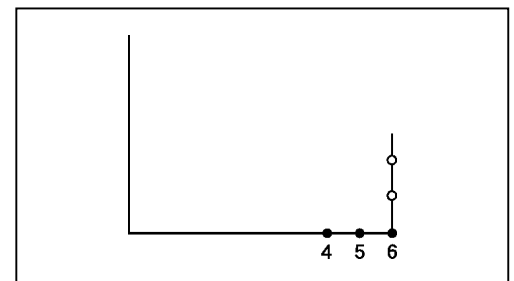

5. Press **ESC**.

6. Continue programming.

## Moving a part of continuous program in parallel

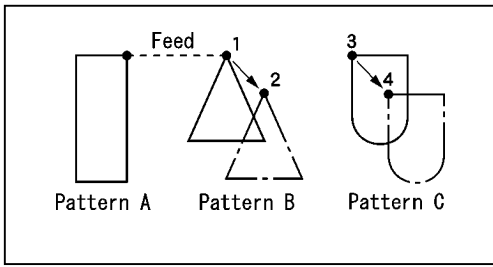

A part of continuous program is moved in parallel. The example in the left is used for explanation of moving patterns B and C in parallel.

### Calling data

1. Press **P**.  
The work clamp moves to the home position. The programmer screen is displayed.

2. Select  with **<>** and press **↓**.



3. Select  with **<>** and press **↓**.



4. Input the data number and press **↓**.



5. Press **ESC**.

### Moving to position 1.

1. Select  with **<>** and press **↓**.



2. Press **9 9 9** and press **+**.  
The work clamp moves from the start position by each stitch.

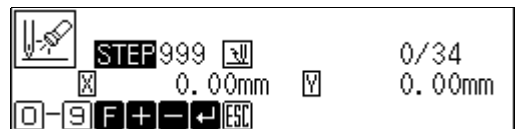

3. When the needle point reaches 1, press .

The work clamp stops. If the work clamp passes, input a few stitches and press . The needle returns for a few stitches of the input.

4. Press .



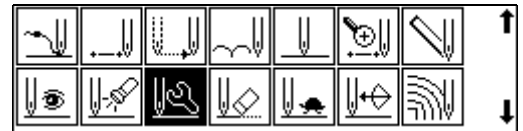

### Moving in parallel

1. Select  with  and press .



2. Select  with  and press .



3. Move the work clamp with . Press  when the needle point is at 2. Move 3 to 4 in the similar manner.

4. Press  three times.

### Saving

1. Select  with  and press .



2. Select  with  and press .



3. Input the data number and press .



4. Press .



### Ending program

1. Press **P**.

### Moving a part of continuous program in parallel partially

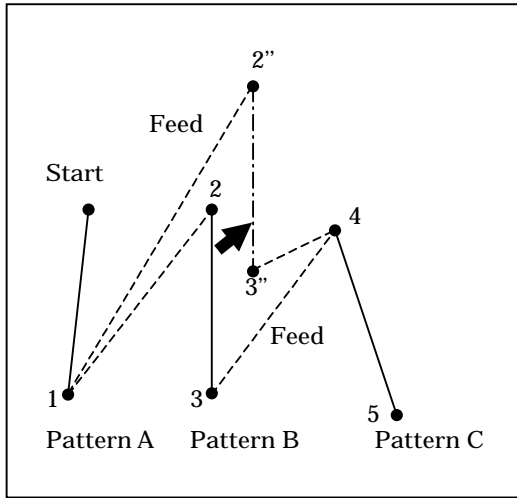

Move a part of continuous program in parallel to the position before the next feed is started. An example on the left describes how to move only pattern B in parallel.

### Calling data

1. Press **P**.  
The work clamp moves to the home position. The programmer screen is displayed.

2. Select  with **◀▶** and press **↵**.



3. Select  with **◀▶** and press **↵**.



4. Input the data number and press **↵**.



5. Press **ESC**.

### Moving to position 2

1. Select  with **◀▶** and press **↵**.



2. Press **+** and move to position 2.  
The work clamp moves from the start point by each stitch.

3. Press **ESC**.

### Moving in parallel

1. Select  with  $\Delta \nabla \triangleleft \triangleright$  and press .

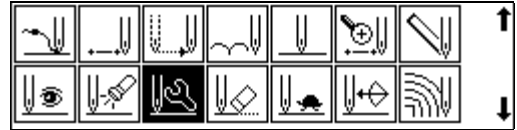

2. Select  with  $\Delta \nabla \triangleleft \triangleright$  and press .



3. Move the work clamp with  $\Delta \nabla \triangleleft \triangleright$  and press  when the needle point is at 2".

4. Press  three times.

### Saving

For details of operation, refer to "Writing data to a floppy disk" (P.216).

1. Select  with  $\triangleleft \triangleright$  and press .



2. Select  with  $\triangleleft \triangleright$  and press .



3. Input the data number and press .

4. Press .



### Ending program

1. Press .

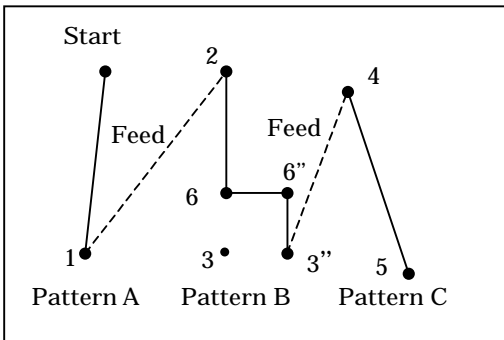

When the movement in parallel is carried out in the midst of the stitch data (position 6 between 2 and 3 in an example on the left), the movement in parallel reaches the start point of the next feed (position 3).

If the moving distance in parallel is 12.7 mm or less, the movement in parallel carried out in the stitch data and if the distance is more than 12.7 mm, the movement in parallel is done in the feed data.

## Canceling thread breakage at the last stitch

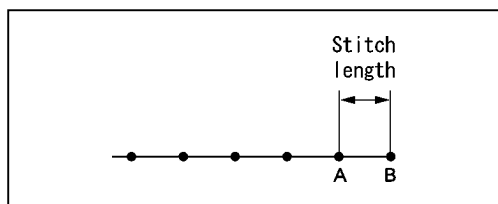

Addition of feed after the last point can cancel thread breakage at the last stitch.

When "115" is input for the end code, the thread breakage does not occur. In this case, every thread breakage including emergency stop is canceled. Carry out the following setting for canceling thread breakage at the specified point.

### Programming

1. Create the program 1 stitch (A) before the desired end point.

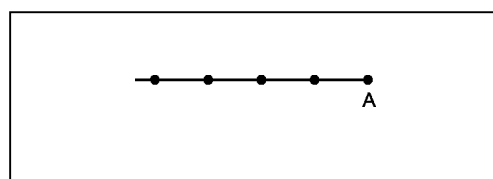

2. Press **ESC**.  
The number of pressing varies depending on the programming method.

3. Select  with **Δ▽◀▶** and press **↵**.

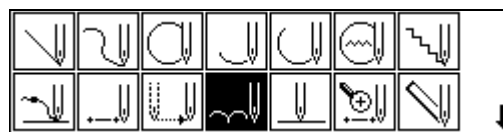

4. Move the work clamp with **Δ▽◀▶** for the stitch length. Press **↵** when the needle point is at point B of the pattern.  
Point B is programmed.

5. Press **ESC**.

- Select  with  $\Delta \nabla \triangleleft \triangleright$  and press .

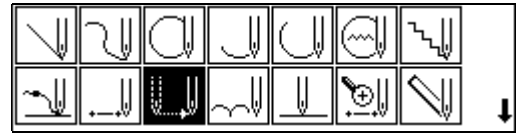

- Move the work clamp with  $\Delta \nabla \triangleleft \triangleright$ . Press  when the needle point is at given point C.

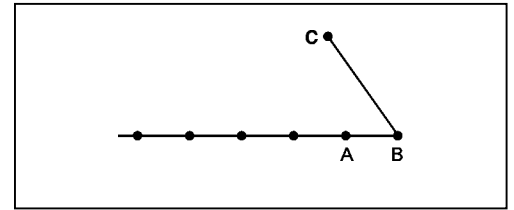



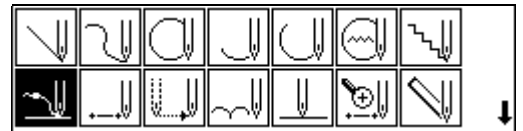

- Press .

### Inputting the end code

- Select  with  $\Delta \nabla \triangleleft \triangleright$  and press .



- Select the end code type with   and press .

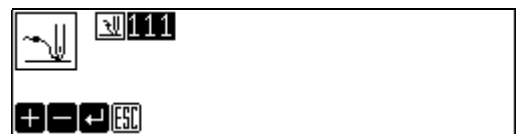

"111" is selected in the example. Press  and the work clamp returns to the first stitch (point A).



- Press .

The work clamp returns to the home position.

### Saving

- Select  with  $\triangleleft \triangleright$  and press .



- Select  with  $\triangleleft \triangleright$  and press .



- Input the data number and press .



4. Press .

Ending program

1. Press .

## Programming

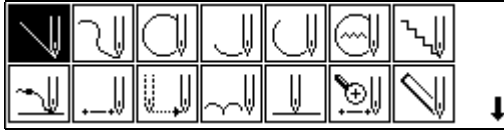

### Creating a line

1. Select  and press .

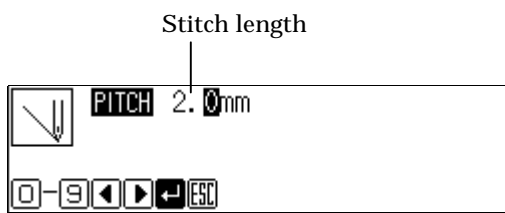

2. Input the stitch length and press .



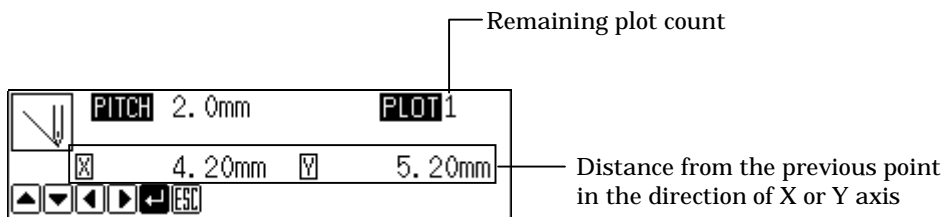

3. Move the needle with     and press .



### Creating a curve

Increase the number of plotting points to create a smoother curve. One to 99 points are available for plotting.

1. Select  and press .

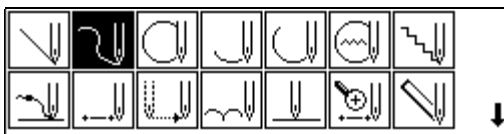

2. Input the stitch length and press .

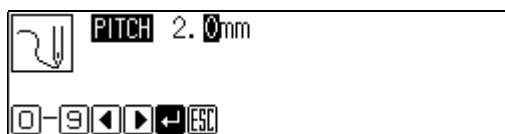

3. Move the needle with and press .

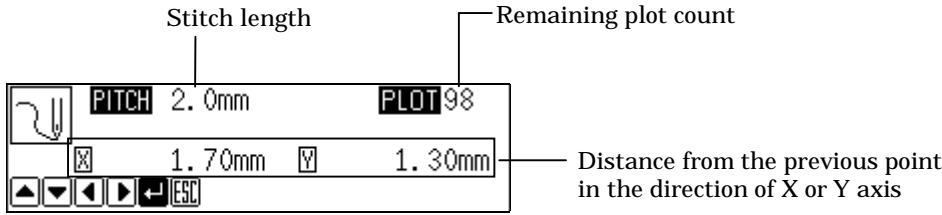

4. Press twice at the sewing end position.

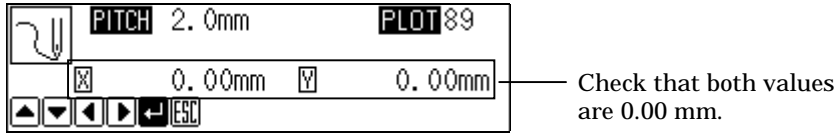

## Creating a circle

The following five options are available for creating a circle.

- Creating a circle by specifying 3 points on the circumference
- Creating a circle of the specified diameter in the clockwise direction
- Creating a circle of the specified diameter in the counterclockwise direction
- Creating a circle of the specified radius in the clockwise direction
- Creating a circle of the specified radius in the counterclockwise direction

1. Select and press . (The position where is pushed becomes the 1st point of the circle.)

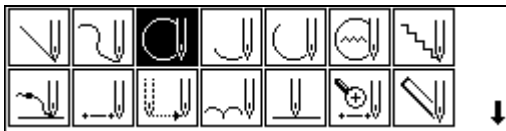

2. Select the method of creating a circle and press .

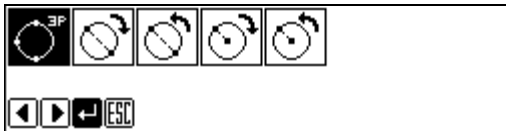



If  is selected

1. Input the stitch length and the overlap stitch count, then press .

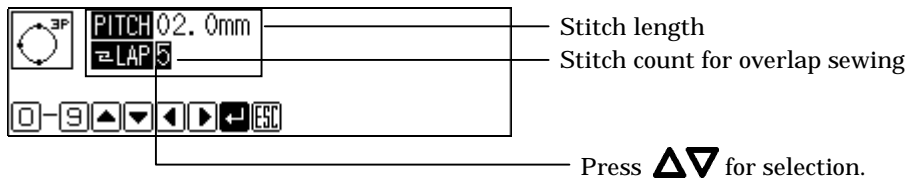
Values of 0 - 9 are available for input.



2. Move the needle with   to select the second point, then press .

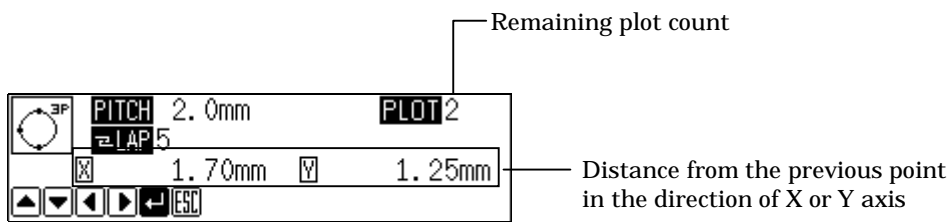

3. Select the third point, then press .

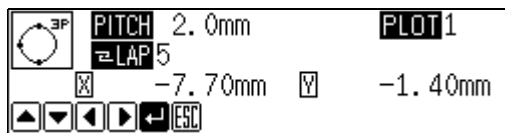



If  are selected

1. Input the stitch length and the overlap stitch count, then press .

Values of 0 - 9 are available for input.

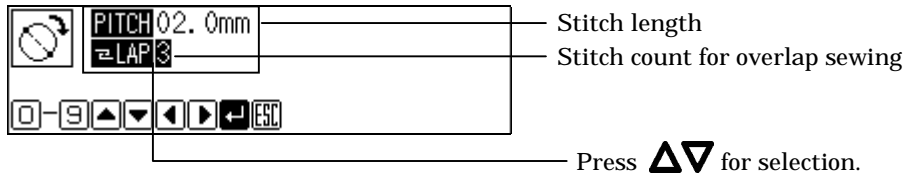

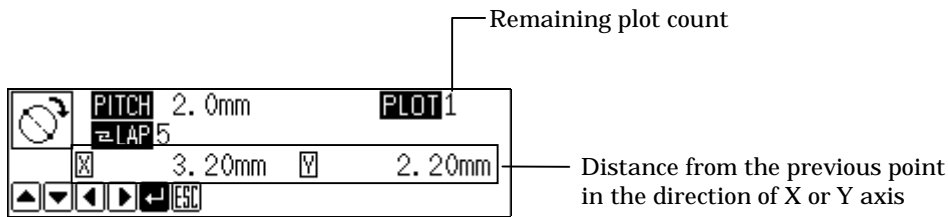

2. Move the needle with  $\Delta \nabla \leftarrow \rightarrow$  and press .



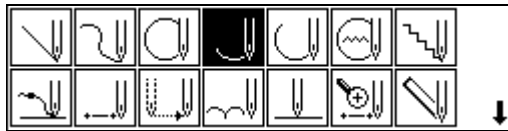

## Creating an arc

1. Select  and press .

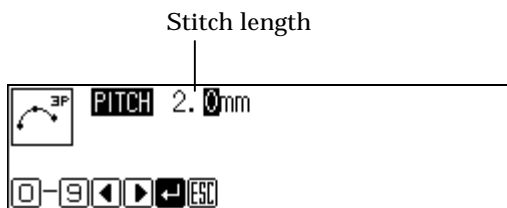

2. Input the stitch length and press .



3. Move the needle with  $\Delta \nabla \leftarrow \rightarrow$  to select the second point, then press .

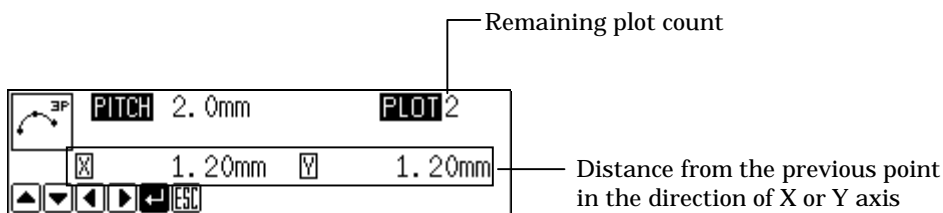



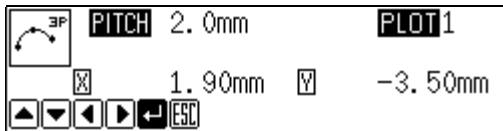

4. Select the third point and press .



## Creating a semicircle

The following two options are available for creating a semicircle.

- 
-  Creating a semicircle of the specified diameter in the clockwise direction
- 
-  Creating a semicircle of the specified diameter in the counterclockwise direction
- 

1. Select  and press .

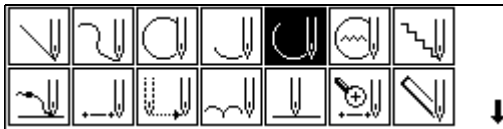

2. Select the method of creating a semicircle, then press .

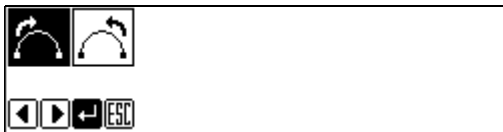

3. Input the stitch length, then press .

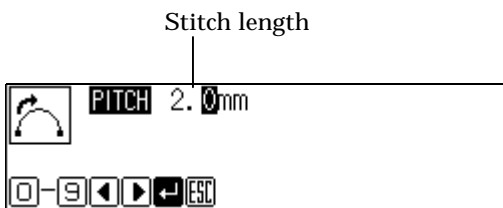

4. Move the needle with  and press .

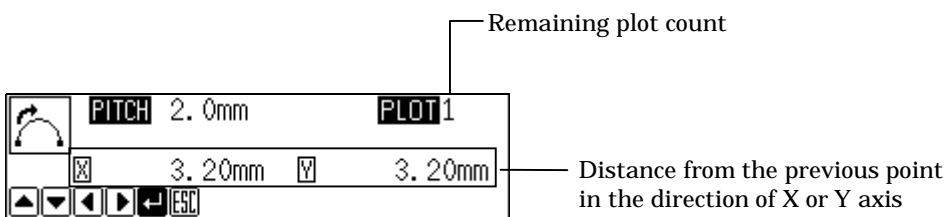

## Creating a zigzag circle

The following five options are available for creating a zigzag circle.

-  Creating a zigzag circle by specifying 3 points on the circumference

---

-  Creating a zigzag circle of the specified diameter in the clockwise direction

---



-  Creating a zigzag circle of the specified diameter in the counterclockwise direction

---

-  Creating a zigzag circle of the specified radius in the clockwise direction

---

-  Creating a zigzag circle of the specified radius in the counterclockwise direction

- Select  and press . (The position where  was pushed becomes the 1st point of the zigzag circle.)

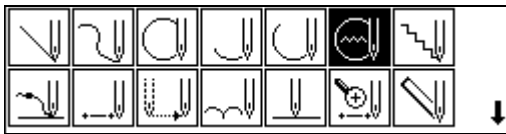



- Select an option of creating a zigzag circle, then press .



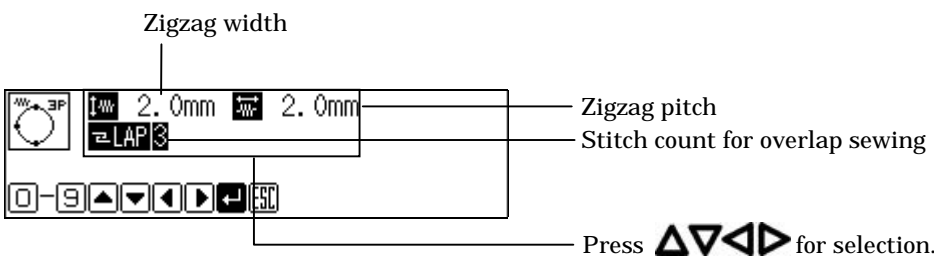

If  is selected

- Input the zigzag stitch width, stitch length and the overlap stitch count, then press . Values of 0 - 9 are available for input.

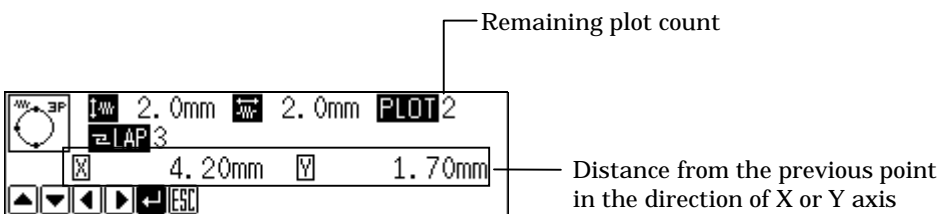

- Move the needle with  to select the second point and press .



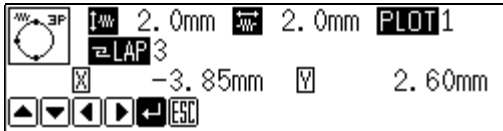

- Select the third point and press .

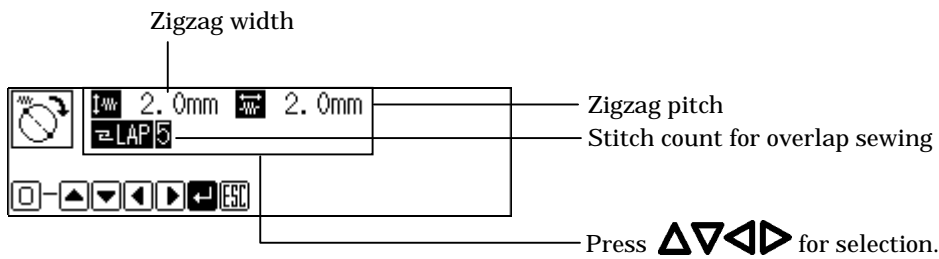

If  are selected

- Input the zigzag stitch width, stitch length and the overlap stitch count, then press . Values of 0 - 9 are available for input.



- Move the needle with  to select the second point and press .

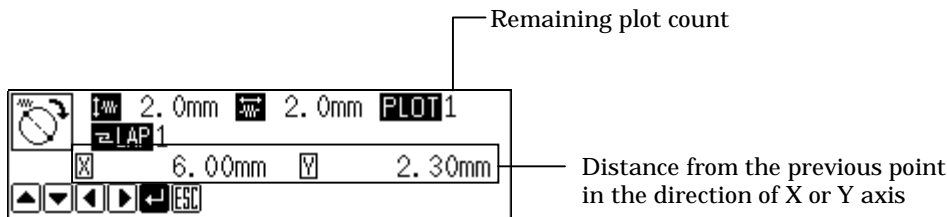

### Creating a zigzag stitch

The following three options are available for zigzag stitch.



Creating a zigzag stitch on the sewing path



Creating a zigzag stitch on the left side of the sewing path



Creating a zigzag stitch on the right side of the sewing path

One to 99 points are available for plotting.

- Select  and press .



2. Select the type of zigzag stitch and press .

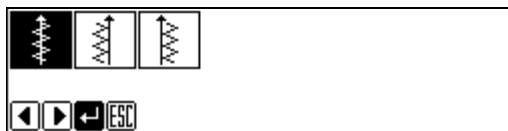

3. Input the stitch width and stitch length, then press .

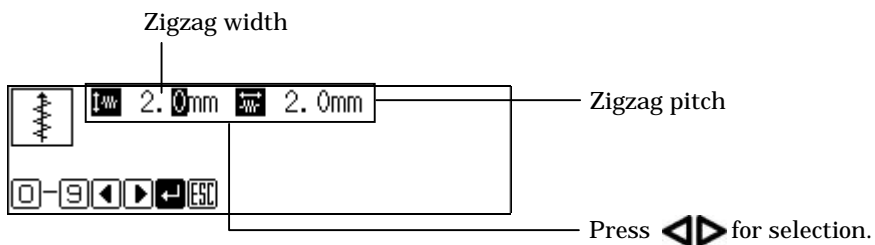

4. Move the needle with    , then press .

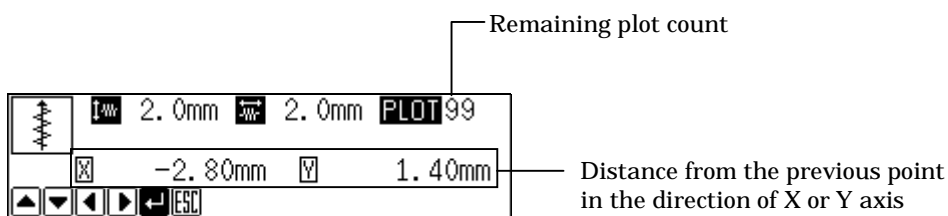

5. Press  twice at the sewing end position.

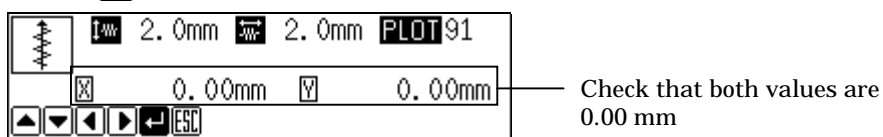

## Ending programming

When programming is completed, input an end code.

The following six end codes are available.

---

111 Normal end

---

112 Fixing the sewing speed at 1000 rpm or lower

---

113 Carrying out no thread wiping

---

114 Setting the sewing speed at 1000 rpm or lower without thread wiping



---

115 Carrying out no thread trimming

---

116 Fixing the sewing speed at 1500 rpm or lower

---

1. Select  and press .



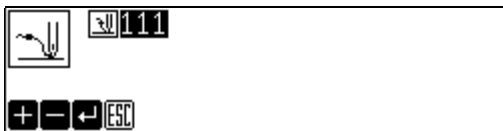

2. Select the end code with  , then press .



## Creating needle drop data

Create needle drop data for the current needle position.

1. Select  and press .

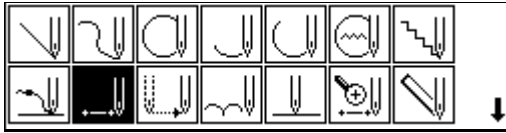

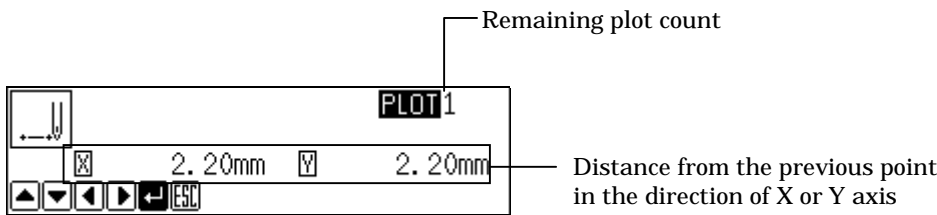

2. Move the needle with , then press .



## Creating feed data

Create (feed) data to move the needle to the next position without needle drop at the current position.

1. Select  and press .

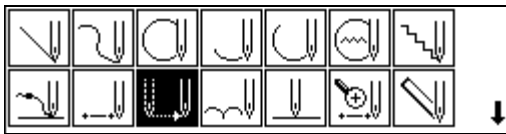

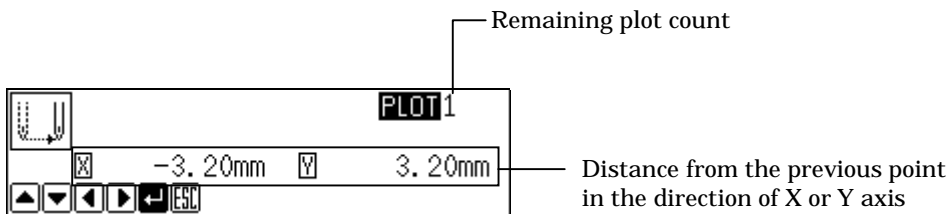

2. Move the needle with , then press .





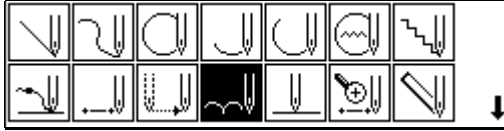

## Creating basting data

Create basting data.

1. Select  and press .



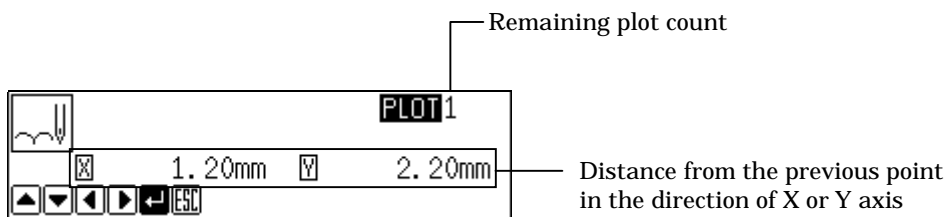

2. Move the needle with    , then press .





## Creating split data

Specify breakpoints for sewing a series of different patterns.

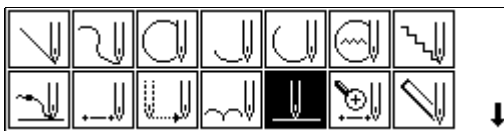
1. Select  and press .



2. Use   to specify whether to stop the needle at the lower end or not, then press .

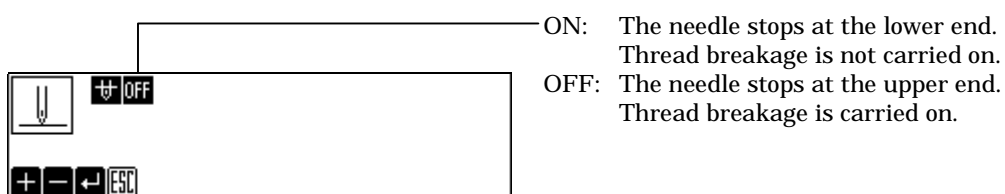





## Creating magnified data

Input small patterns in magnified sizes.

Three magnification scales of  $\times 2$ ,  $\times 5$  and  $\times 10$  are available. Prepare pattern sheets suitable for the magnified patterns.

Press **ESC** or **C** to contract the magnified data.

1. Select  and press **↓**.

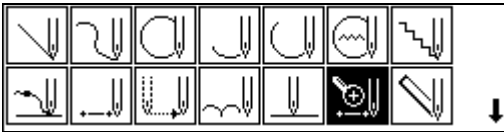

2. Select magnification and press **↓**.

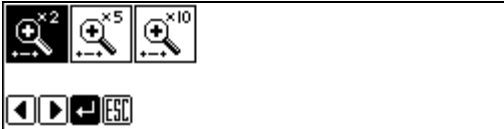



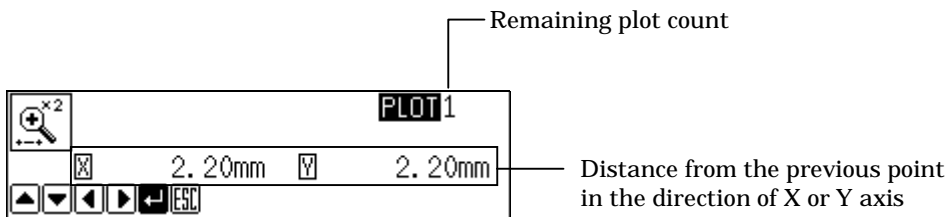



3. Move the needle with **△▽◀▶**, then press **↓**.



4. Press **ESC** or **C**.

## Carrying out double stitch

The following six options are available for double stitch.

- |   |   |
|---|---|
|  | Creating double stitch data in the reverse direction to the left side of the sewing path  |
|  | Creating double stitch data in the reverse direction to the right side of the sewing path |
|  | Creating double stitch data in the same direction to the left side of the sewing path     |
|  | Creating double stitch data in the same direction to the right side of the sewing path    |
|  | Offsetting double stitch data to the left side of the sewing path                         |
|  | Offsetting double stitch data to the right side of the sewing path                        |

If sharp angles or fine curves are included in the pattern sheet, the desired double stitch may not be achieved.

1. Select  and press .

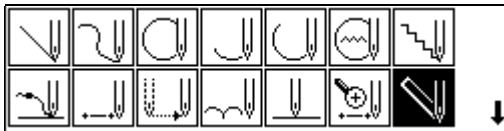

2. Select the type of double stitch and press .

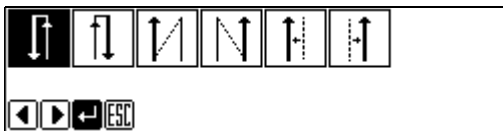

3. Input the stitch length and the double stitch width, then press .

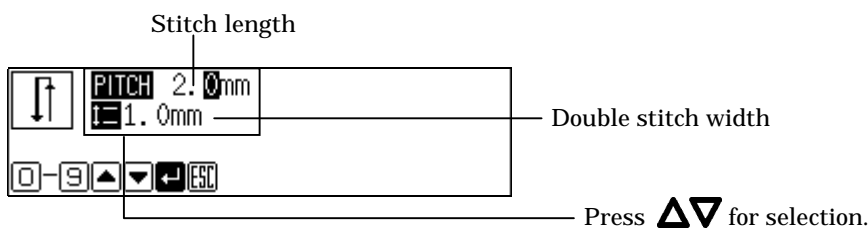

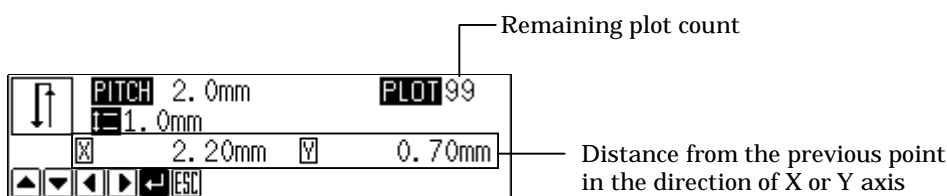

4. Move the needle with , then press .



Press  twice to change the direction of sewing.

5. Press  at the sewing end position.

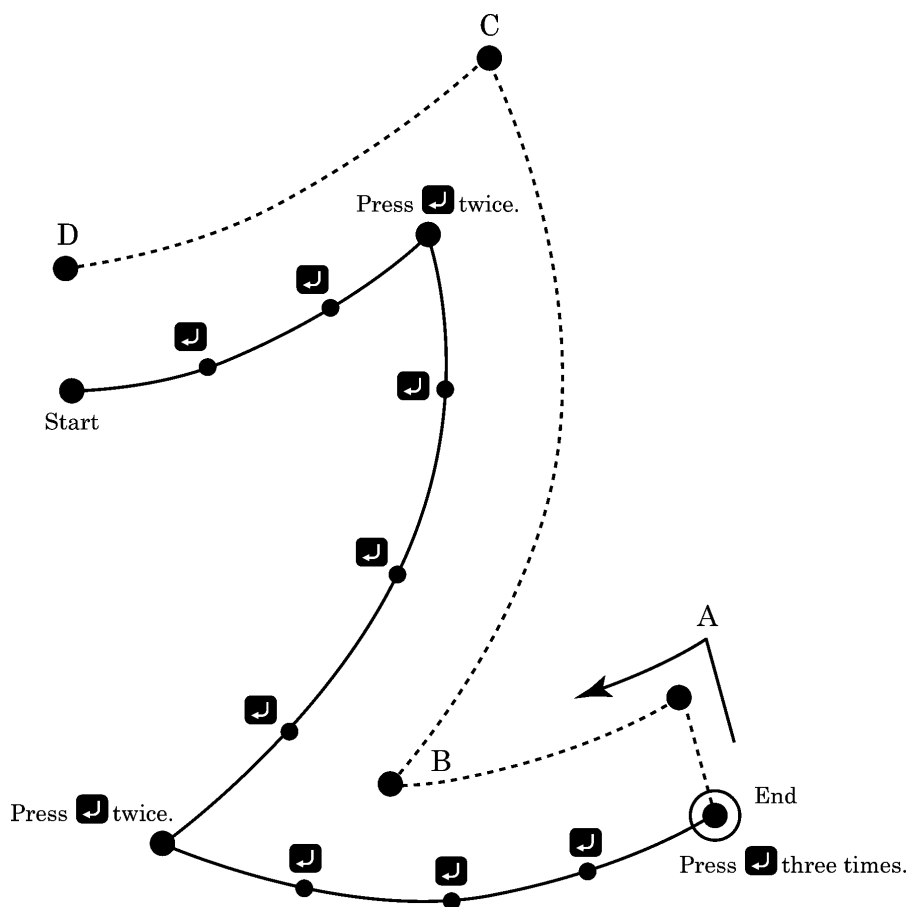

An alarm sounds after  is pressed twice. After the alarm, press  again.

Then an alarm sounds and the double stitch pattern is calculated. When the alarm stops, the needle moves in the order of  $A \rightarrow B \rightarrow C \rightarrow D$ . The program is completed when the needle comes to D.



## Displaying the data image during programming

A data image is displayed during programming.

1. Select  and press .

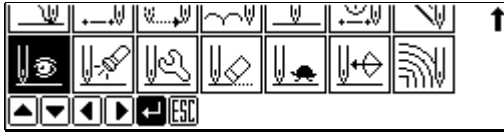

The pattern image is displayed. Press  or  to return to the main menu.

Displays the stitch count.

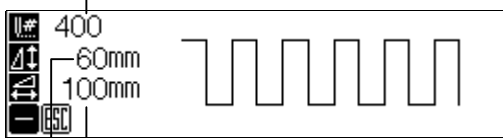

Displays the horizontal length.

Displays the longitudinal length.

Press  to display the overall sewing area.

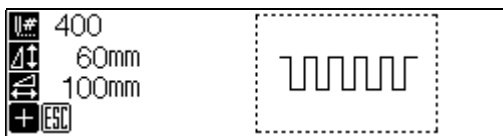

Press  to display the overall view of data.



## Checking the program setting and setting attribute

Refer to "Checking the program setting and setting attribute" (page 109).



## Editing the current data

The following options are available as editing functions.

- |  |   |
|--|---|
|  | Moving data of the needle positions after the current position in parallel by feeding                         |
|  | Moving data of the needle positions after the current position in parallel by sewing with the specified pitch |
|  | Moving data of the needle positions after the current position in parallel                                    |
|  | Copying repeatedly the previous data on the current and the following needle positions                        |
|  | Copying the previous data symmetrically to the Y axis on the current and the following needle positions       |
|  | Copying the previous data symmetrically to the X axis on the current and the following needle positions       |
|  | Copying the previous data symmetrically to a point on the current and the following needle positions          |
|  | Copying the previous data in the reverse direction on the current and the following needle positions          |
|  | Changing the stitch length or the number or lines for a multiple stitch                                       |

Adjust the needle position before editing.

Refer to "Checking the program setting and setting attribute" (page 109) for adjustment.

1. Select and press .



If  is selected

1. Adjust the destination with , then press .

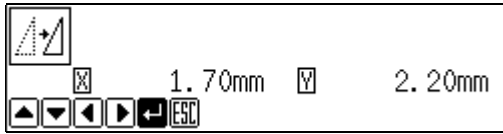

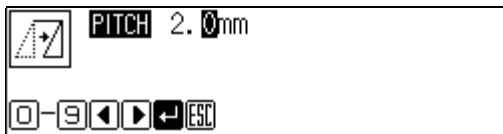

If  is selected

1. Input the stitch length, then press .



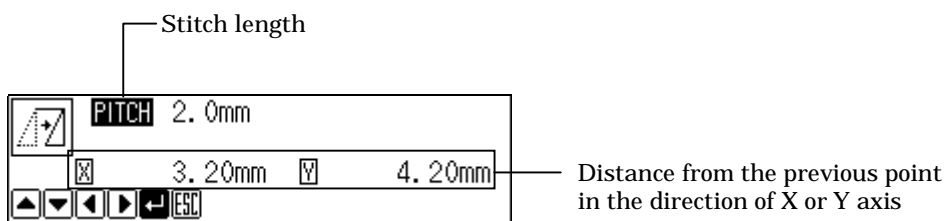

2. Adjust the destination with , then press .

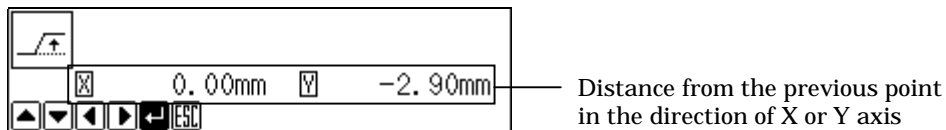

If  is selected

1. Adjust the destination with , then press .



If , , ,  or  is selected

Data chunks separated with feed data are copied.

If the number of ignored boundary feeds is 0:

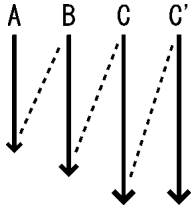

Data unit C is copied.

If the number of ignored boundary feeds is 1:

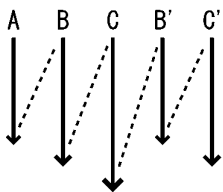

Data unit B and C are copied.

If the number of ignored boundary feeds is 2:

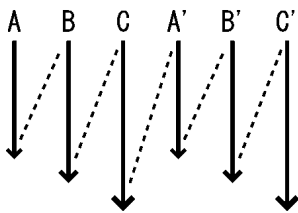

Data unit A, B and C are copied.

1. Input the number of feed boundaries to be neglected.  
Inputting 99 ignores all boundaries.



2. Press .





## Deleting a part of data

Adjust the needle position before deletion.



Refer to "Checking the program setting and setting attribute" (page 109) for adjustment.

1. Select  and press .

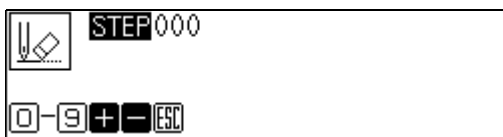

2. Input the stitch count to delete.



3. Press  to delete data following the current needle position for the input count. Press  to delete data prior to the current needle position.

The corresponding data is deleted.

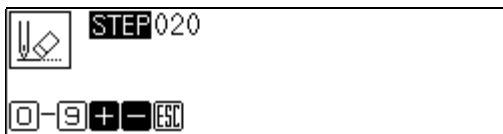





## Setting low-speed sewing



Carries out setting for low-speed sewing.

The following five options are available for low-speed sewing.

0 (Low-speed 0)	Sewing speed is not reduced. (Used for canceling other options.)
1 (Low-speed 1)	The maximum sewing speed is set at 1200 rpm or lower.
2 (Low-speed 2)	The maximum sewing speed is set at 800 rpm or lower.
3 (Low-speed 3)	The maximum sewing speed is set at 600 rpm or lower.
4 (Low-speed 4)	The maximum sewing speed is set at 400 rpm or lower.

1. Select  and press .



2. Select an option of low-speed sewing with  .

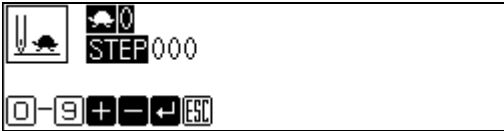

3. Input the stitch count for sewing with the reduced maximum speed.

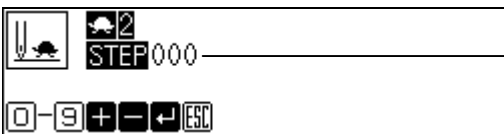

Input the desired stitch count.

4. Press .  
Low-speed sewing is carried out for the input stitch count.

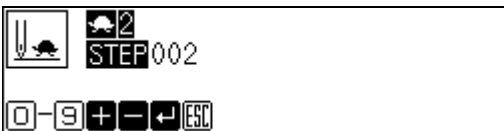



## Inputting the trigger (BAS-300 Series)

\* This function is not available to KE-436B, 436C.

Input the trigger for the extended option output.

Adjust the needle position before inputting the trigger and setting attribute.





Refer to "Checking the program setting and setting attribute" (page 109).

1. Select  and press .



2. Input the option output number.



3. Move with  , then use   to specify whether to stop the machine or not.



ON: The needle stops at the upper end without thread breakage, and restarts after output of the extended option.  
OFF: Sewing does not stop.

## Creating a multiple stitch

1. Select  and press .

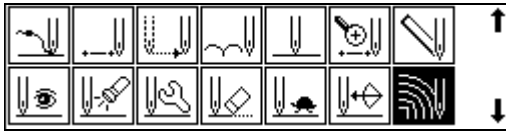



2. Input the stitch length and the number of lines for a multiple stitch. Press .



3. Move the needle point with    and press .



When the embroidering direction should be changed, provide a split by pressing  twice.

Press  and move the needle point from the inside line to the outside line (reversely).  becomes valid after input of a split.

When programming, be sure that the points and splits specified on the inside line are paired with those on the outside line respectively.

4. When the needle point has reached the end point, press  three times.

A buzzer sounds. Calculation is performed based on the input data. A buzzer stops on completion of programming.

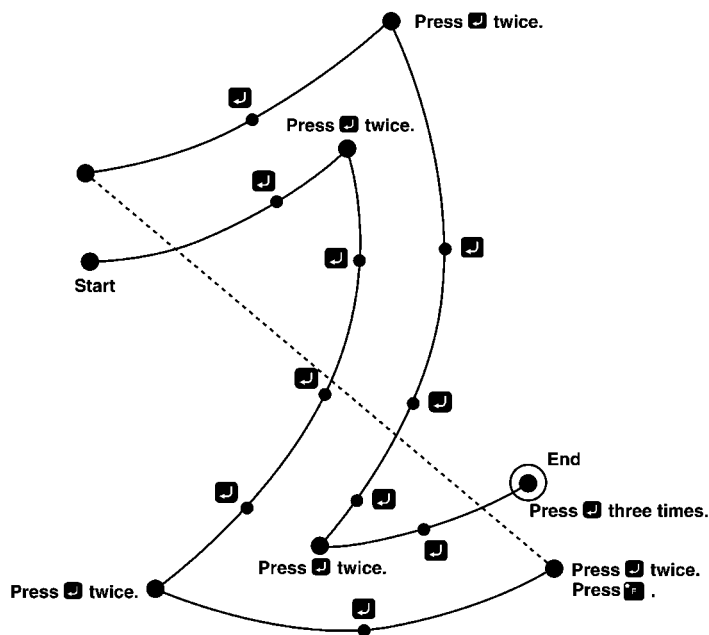

## Modifying the program of a multiple stitch

When modifying the stitch length or the number of lines for a multiple stitch, the previously created curve program can be used.

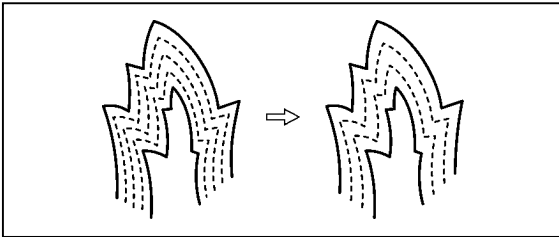

The previously created programs are required for modifying programs of multiple stitch.

Programs of multiple stitch written to floppy disks cannot be modified.

1. Select  and press .



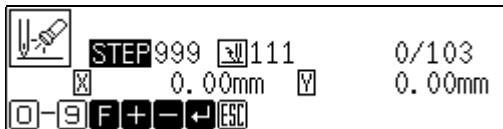

2. Press **9 9 9 +**.



The work clamp moves. When the needle point is at the start point for a multiple stitch, stop it by pressing .

3. Press **ESC**.

4. Select  and press .



5. Select  and press .

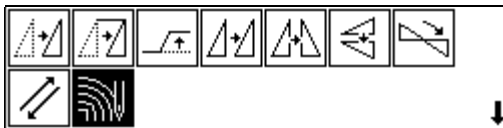



6. Input the stitch length and the number of lines. Press .





Calculation is performed based on the input data. When a buzzer stops, the needle point moves to the end point for a multiple stitch.

## Displaying a pattern image

A data image is displayed during programming or editing.

1. Select  and press .



The pattern image is displayed. Press  or  to return to Main menu.

Displays the stitch count.

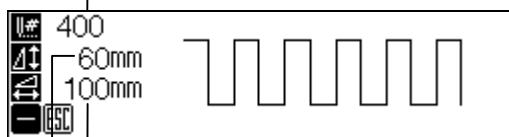

Press  to display the overall sewing area.

Displays the lateral length.

Displays the longitudinal length.

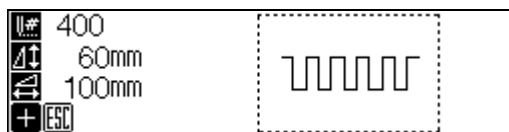

Press  to display the overall view of data.



## Checking the program setting and setting attribute

### Checking the program setting and setting attribute

The following items are displayed.

End code	
Current needle position/Total stitch count	
Distance from the previous position in the X and Y axial directions	
Stitch data type and availability of the option output, low-speed sewing(*)	Displayed at points where stitch is set.
Feed data type and availability of the option output, with/without thread.	Displayed at points where feed data is set
Needle stop position of the split data (*)	Displayed at points where split data is set.
Extended option output no. of the trigger data and with/without machine stoppage (*) (BAS-300Series)	Displayed at points where trigger is set.

Attribute of items marked with \* are available for setting.

An example of stitch data is shown below.

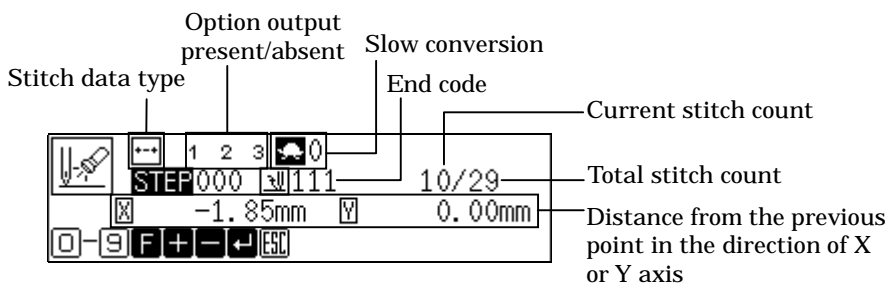

1. Select or and press



Selecting from the main menu



Selecting from the data programming menu

## Checking each stitch

1. Press **+** to move forward, **-** to backward.

The needle steps by each stitch and the setting of the data is displayed.



## Checking a series of stitches automatically

1. Input the stitch count to check.
2. Press **+** to move forward, **-** to backward.

The needle moves by the input count and the setting of the data is displayed. Input "999" to check all stitches.



## Skipping

1. Input the stitch count to the destination.
2. Press **F**, then press **+** to move forward and **-** to move backward.

The needle skips sewing according to the input stitch count.

Input "999" to skip sewing to the sewing end position or to a breakpoint.

## Setting the attribute (stitch data)

1. Move to the desired needle position and press **↓**.

The attribute setting screen appears.



2. Set the attribute.

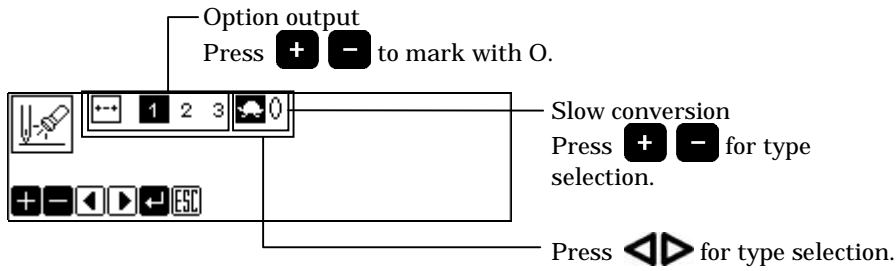

3. Press **↵** after setting.

The screen returns to the confirmation screen.



### Setting the attribute (feed data)

1. Move to the desired needle position and press **↵**.

The attribute setting screen appears.

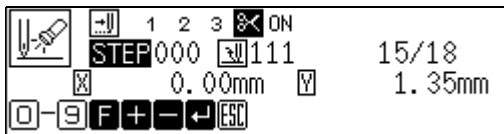

2. Set the attribute.

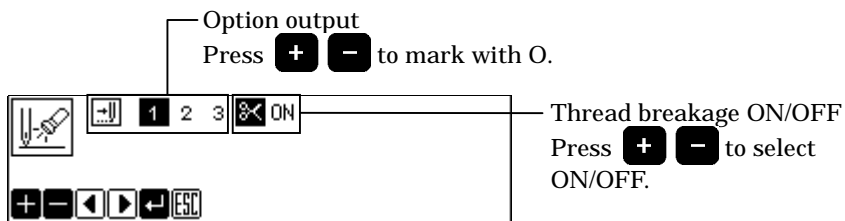

3. Press **↵** after setting.

The screen returns to the confirmation screen.

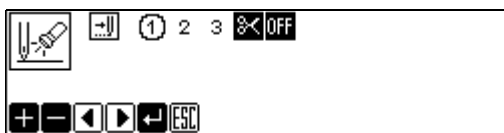



### Setting the attribute (split data)



1. Move to the desired needle position and press .

The attribute setting screen appears.

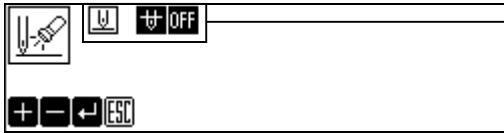

2. Set the attribute.



Stoppage of the needle at the lower end  
Press   to select ON/OFF.

3. Press  after setting.

The screen returns to the confirmation screen.





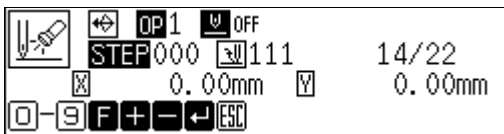

### Setting the attribute (trigger data) (BAS-300 Series)

1. Move to the desired needle position and press .



The attribute setting screen appears.

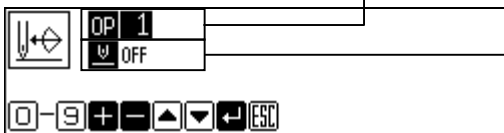

2. Set the attribute.

Extended option output trigger  
Press   or  -  to select the number.



Machine stop  
Press   to select ON/OFF.

3. Press  after setting.











The screen returns to the confirmation screen.



## Editing program

Edit the retrieved or created data.

The following options are available as editing functions.

- |  |  |
|--|--|
|   | Moving a pattern in parallel. (Changes the sewing start position.) |
|   | Moving a pattern symmetrically to the Y axis                       |
|   | Moving a pattern symmetrically to the X axis                       |
|   | Moving a pattern symmetrically to a point                          |
|   | Resizing a pattern   |
|   | Copying a resized pattern  |
|   | Rotating a pattern clockwise                                       |
|   | Copying a pattern rotated clockwise                                |
|   | Rotating a pattern counterclockwise                                |
|  | Copying a pattern rotated counterclockwise                         |

1. Select  and press .



2. Select an editing function and press .

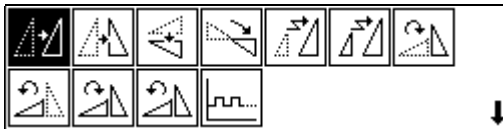

If  is selected

1. Adjust the distance in the X and Y directions with .

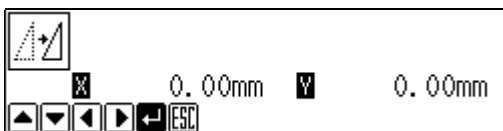

2. Press .



If ,  or  is selected

1. Press .

The pattern is moved symmetrically to the sewing start position.

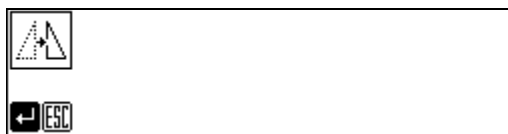

If  is selected

1. Input resizing scale in the X and Y directions.

Switch between X and Y directions with .

Resizing scale between 0 and 400% are available.



2. Input the stitch length.



Switch between input fields of stitch length with .

If the stitch length is 0.0, the pattern is resized with the same number of stitches as the original data.



3. Press .



4. Use    to change the reference position for resizing.

Resizing scale in the X axis direction

Resizing scale in the Y axis direction

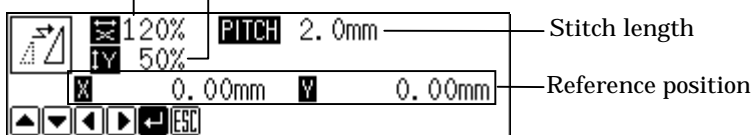

5. Press .

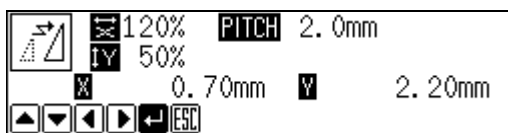

If  is selected

Data chunks separated with feed data are resized and copied.

If the number of feed boundaries to be ignored is 0:

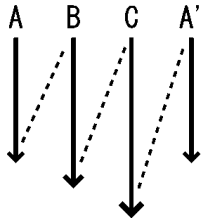

Only A is copied.  
A' becomes a split program.

If the number of feed boundaries to be ignored is 1:

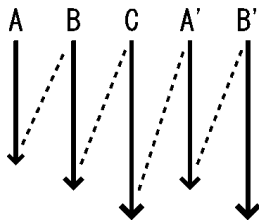

A and B are copied.  
A' and B' become split programs.

If the number of feed boundaries to be ignored is 2:

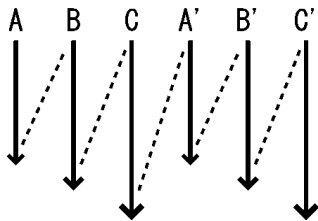

A, B and C are copied.  
A', B' and C' become split programs.

### 1. Input resizing scale in the X and Y directions.

Switch between X and Y directions with .

Resizing scale between 0 and 400% are available.



### 2. Input the stitch length.

Switch between the input fields of stitch length with .

If the stitch length is 0.0, the pattern is resized with the same number of stitches as the original data.



- Input the number of the feed boundaries to be ignored and press . Inputting 99 ignores all boundaries.



- Use to change the reference position for resizing. If no reference position is specified, the home position is used as the reference. Resizing scale in the X axis direction

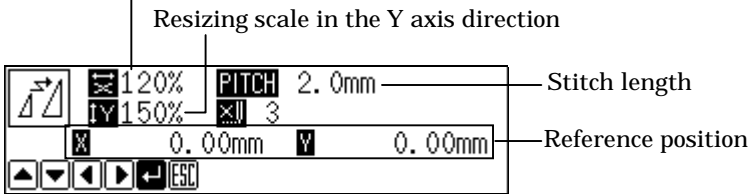

- Press .



The copied data is added as split data.

If or is selected

- Input the angle of rotation and press .



- Adjust the reference position for rotation with , then press .

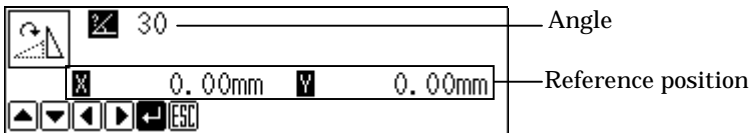



If  or  is selected

1. Input the angle of rotation and number of feed boundaries to be ignored, then press .

Inputting 99 ignores all boundaries. Refer to "If  is selected" (page 115.)



2. Adjust the reference position with   and press .

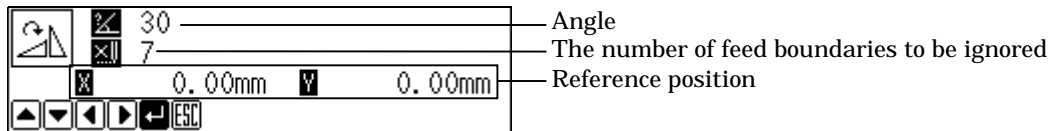



## Deleting data

---

Delete the current program data.

1. Press **ESC** or **C** and return to Main menu.

2. Select  and press **J**.



3. Check the screen and press **J**.  
Press **ESC** to cancel this command.

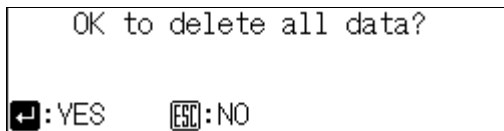

# Chapter 3

## Programming with Command Function



# Please read before programming

Pressing a designated combination of keys will issue a command to the programmer. These key combinations are called 'command'. This chapter describes the method of programming with command.

## Panel description and usage

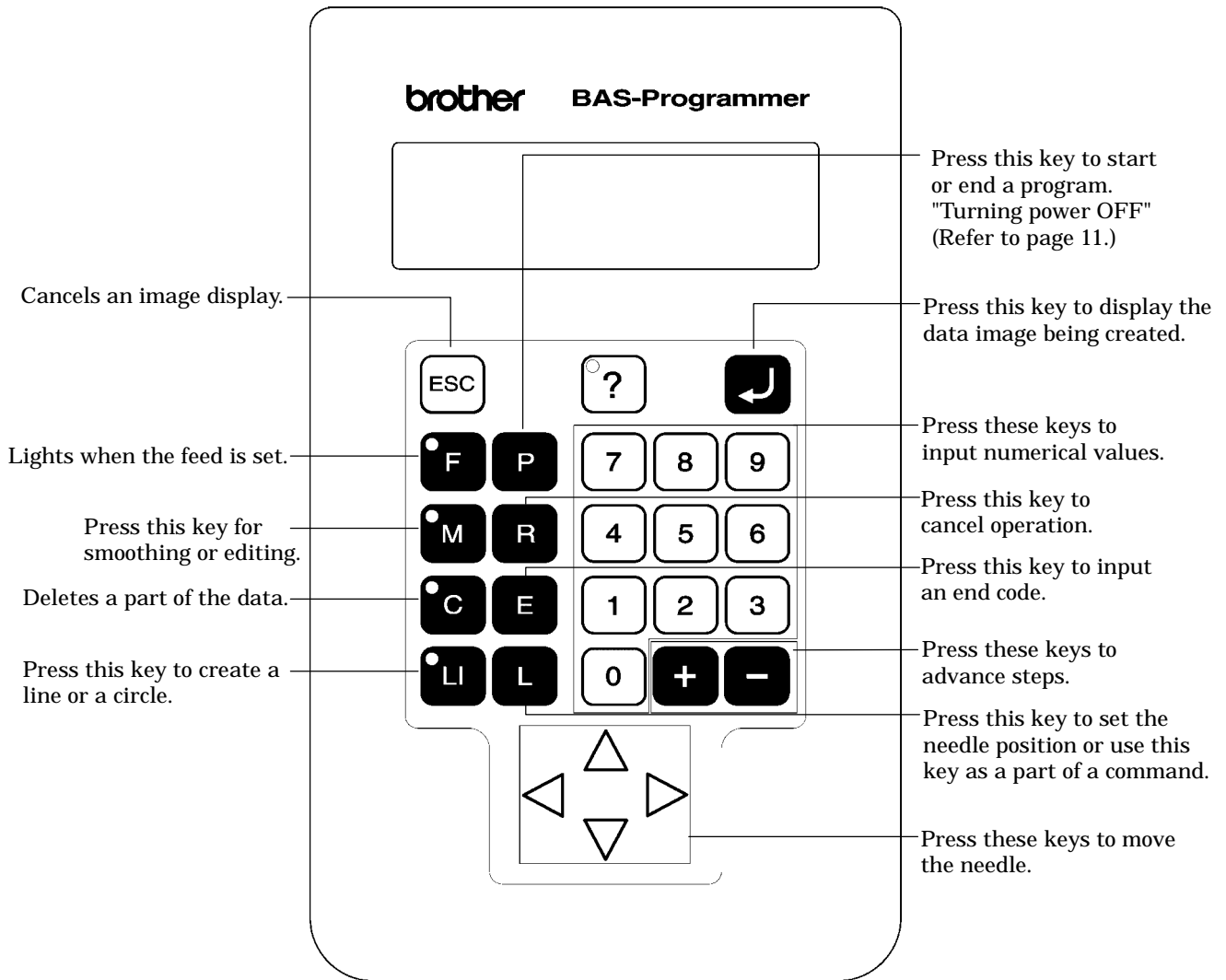

## Display screen

Press **P** and the following screen appears.

If the screen is not displayed, press **?**.

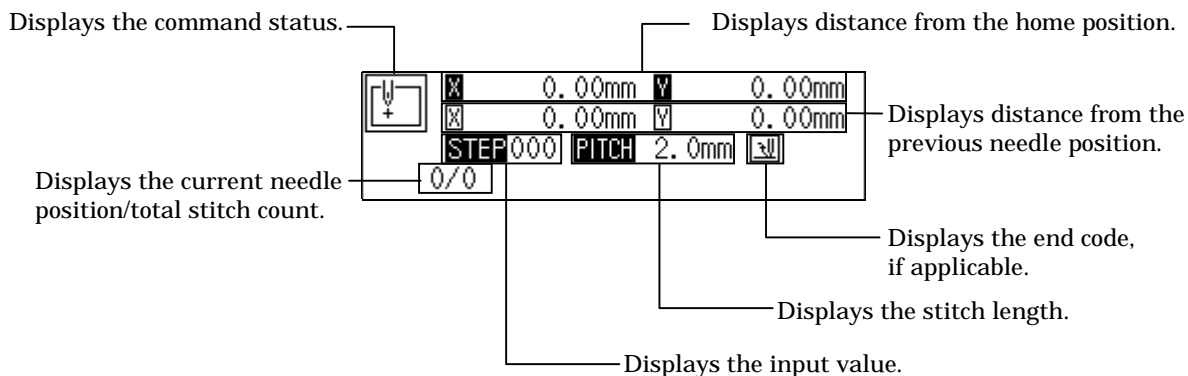

## Programming flowchart

### Programming

Position the sewing start position and press **L**.



Input the command for programming.

(Refer to page 163.)

Combine straight lines, curves and other figures to make patterns to the pattern sheet. After completing each pattern, press **L**.  
The data is available until deletion.



Input end code.

(Refer to page 181.)

## Editing

Move to the home position or the needle position for editing.



Input command for editing.  
(Refer to page 182.)

## Checking and setting

Move to the needle position for editing.



Input command and carry out setting.

## Description of commands

### Moving needle point

<input type="text"/> <input type="text"/> <input type="text"/> +	Proceeding by <input type="text"/> <input type="text"/> <input type="text"/> stitches
<input type="text"/> <input type="text"/> <input type="text"/> -	Returning by <input type="text"/> <input type="text"/> <input type="text"/> stitches
<input type="text" value="9"/> <input type="text" value="9"/> <input type="text" value="9"/> +	Proceeding to the end point
<input type="text" value="9"/> <input type="text" value="9"/> <input type="text" value="9"/> -	Returning to the first point
<b>F</b> <input type="text"/> <input type="text"/> <input type="text"/> +	Proceeding by skipping <input type="text"/> <input type="text"/> <input type="text"/> stitches
<b>F</b> <input type="text"/> <input type="text"/> <input type="text"/> -	Returning by skipping <input type="text"/> <input type="text"/> <input type="text"/> stitches
<b>F</b> <input type="text" value="9"/> <input type="text" value="9"/> <input type="text" value="9"/> +	Skipping to the end point (not applicable at the home position)
<b>F</b> <input type="text" value="9"/> <input type="text" value="9"/> <input type="text" value="9"/> -	Skipping to the first point
<b>R</b>	Returning the position to the home position.

### Deleting data

<input type="text" value="2"/> <input type="text" value="2"/> <input type="text" value="2"/> <b>R</b>	Deleting all data.
<b>C</b> <input type="text"/> <input type="text"/> <input type="text"/> +	Deleting data from <input type="text"/> <input type="text"/> <input type="text"/> stitches
<b>C</b> <input type="text"/> <input type="text"/> <input type="text"/> -	Deleting data before <input type="text"/> <input type="text"/> <input type="text"/> stitches

### Ending programming

<input type="text" value="1"/> <input type="text" value="1"/> <input type="text" value="1"/> <b>E</b>	Normal end
<input type="text" value="1"/> <input type="text" value="1"/> <input type="text" value="2"/> <b>E</b>	Fixing the sewing speed at 1000 rpm or lower.
<input type="text" value="1"/> <input type="text" value="1"/> <input type="text" value="3"/> <b>E</b>	Carrying out no thread wiping.
<input type="text" value="1"/> <input type="text" value="1"/> <input type="text" value="4"/> <b>E</b>	Setting the sewing speed at 1000 rpm or lower without thread wiping.
<input type="text" value="1"/> <input type="text" value="1"/> <input type="text" value="5"/> <b>E</b>	Carrying out no thread trimming.
<input type="text" value="1"/> <input type="text" value="1"/> <input type="text" value="6"/> <b>E</b>	Fixing the sewing speed at 1500 rpm or lower.

## Creating program

<input type="text" value="0"/> <input type="text" value="0"/> <input type="text" value="0"/> <input type="button" value="L"/>	Creating a line. Input the stitch length in <input type="text" value="0"/> <input type="text" value="0"/> <input type="text" value="0"/> .
<input type="text" value="2"/> <input type="text" value="0"/> <input type="text" value="0"/> <input type="button" value="L"/>	Creating a circle by specifying 3 points. Input the overlap stitch counts in <input type="text" value="0"/> .
<input type="text" value="2"/> <input type="text" value="1"/> <input type="text" value="0"/> <input type="button" value="L"/>	Creating a circle in the clockwise direction by specifying the diameter. Input the overlap stitch counts in <input type="text" value="0"/> .
<input type="text" value="2"/> <input type="text" value="2"/> <input type="text" value="0"/> <input type="button" value="L"/>	Creating a circle in the counterclockwise direction by specifying the diameter. Input the overlap stitch counts in <input type="text" value="0"/> .
<input type="text" value="2"/> <input type="text" value="3"/> <input type="text" value="0"/> <input type="button" value="L"/>	Creating a circle in the clockwise direction by specifying the radius. Input the overlap stitch counts in <input type="text" value="0"/> .
<input type="text" value="2"/> <input type="text" value="4"/> <input type="text" value="0"/> <input type="button" value="L"/>	Creating a circle in the counterclockwise direction by specifying the radius. Input the overlap stitch counts in <input type="text" value="0"/> .
<input type="text" value="3"/> <input type="text" value="0"/> <input type="text" value="0"/> <input type="button" value="L"/>	Creating an arc by specifying 3 points
<input type="text" value="3"/> <input type="text" value="1"/> <input type="text" value="0"/> <input type="button" value="L"/>	Creating a semicircle in the clockwise direction
<input type="text" value="3"/> <input type="text" value="2"/> <input type="text" value="0"/> <input type="button" value="L"/>	Creating a semicircle in the counterclockwise direction
<input type="text" value="0"/> <input type="text" value="0"/> <input type="text" value="0"/> <input type="button" value="M"/>	Creating a curve. Input a stitch pitch in <input type="text" value="0"/> . Input <input type="text" value="7"/> <input type="text" value="8"/> <input type="text" value="9"/> <input type="button" value="L"/> to complete the curve data.
<input type="text" value="2"/> <input type="text" value="0"/> <input type="text" value="0"/> <input type="button" value="M"/>	Creating a double stitch in the reverse direction to the sewing path. Input the width of double stitch in <input type="text" value="0"/> <input type="text" value="0"/> .
<input type="text" value="3"/> <input type="text" value="0"/> <input type="text" value="0"/> <input type="button" value="M"/>	Creating an parallel stitch in the same direction to the sewing path. Input the width of parallel stitch in <input type="text" value="0"/> <input type="text" value="0"/> .
<input type="text" value="4"/> <input type="text" value="0"/> <input type="text" value="0"/> <input type="button" value="M"/>	Creating an offset. Input the width for offset in <input type="text" value="0"/> <input type="text" value="0"/> .
<input type="text" value="5"/> <input type="text" value="0"/> <input type="text" value="0"/> <input type="button" value="M"/>	Starting a multiple stitch.
<input type="text" value="5"/> <input type="text" value="0"/> <input type="text" value="0"/> <input type="button" value="M"/>	Creating a multiple stitch. Input the number of lines for a multiple stitch in <input type="text" value="0"/> <input type="text" value="0"/> .
<input type="text" value="7"/> <input type="text" value="0"/> <input type="text" value="0"/> <input type="button" value="M"/>	Creating a zigzag stitch. Input the width of zigzag in <input type="text" value="0"/> <input type="text" value="0"/> , and input the pitch of zigzag stitch by pressing <input type="text" value="0"/> <input type="text" value="0"/> <input type="text" value="0"/> <input type="button" value="M"/> .
<input type="text" value="9"/> <input type="text" value="0"/> <input type="text" value="2"/> <input type="button" value="M"/>	Inputting data (×2)
<input type="text" value="9"/> <input type="text" value="0"/> <input type="text" value="5"/> <input type="button" value="M"/>	Inputting data (×5)
<input type="text" value="9"/> <input type="text" value="1"/> <input type="text" value="0"/> <input type="button" value="M"/>	Inputting data (×10)
<input type="text" value="2"/> <input type="text" value="2"/> <input type="text" value="0"/> <input type="button" value="L"/>	Stopping the needle at the upper end by split
<input type="text" value="2"/> <input type="text" value="2"/> <input type="text" value="1"/> <input type="button" value="L"/>	Stopping the needle at the lower end by split
<input type="text" value="7"/> <input type="text" value="8"/> <input type="text" value="7"/> <input type="button" value="L"/>	Carrying out zigzag stitch on the right side to the sewing path

<b>7</b> <b>8</b> <b>8</b> <b>L</b>	Carrying out zigzag stitch on the left side to the sewing path Carrying out double stitch on the right side to the sewing path Carrying out parallel stitch on the right side to the sewing path Carrying out offset on the right side to the sewing path
<b>7</b> <b>8</b> <b>9</b> <b>L</b>	Ending input for a curve Carrying out zigzag stitch symmetrically to the sewing path Carrying out double stitch on the left side to the sewing path Carrying out parallel stitch on the left side to the sewing path Carrying out offset on the left side to the sewing path
<b>F</b> <b>6</b> <b>6</b> <b>6</b> <b>L</b>	Specify split points (for sewing different patterns separately in a sequence) after feed
<b>F</b> <b>7</b> <b>7</b> <b>7</b> <b>L</b>	Moving in parallel for the feed
<b>F</b> <b>8</b> <b>8</b> <b>8</b> <b>L</b>	Creating split data after basting data
<b>F</b> <b>9</b> <b>9</b> <b>9</b> <b>L</b>	Creating basting data

## Editing data



<b>0</b> <b>0</b> <b>1</b> <b>M</b>	Moving a pattern symmetrically to the Y axis
<b>0</b> <b>1</b> <b>0</b> <b>M</b>	Moving a pattern symmetrically to the X axis
<b>0</b> <b>1</b> <b>1</b> <b>M</b>	Moving a pattern symmetrically to a point
<b>5</b> <input type="text"/> <input type="text"/> <b>M</b>	Modifying a multiple stitch. Input the number of lines for a multiple stitch in <input type="text"/> <input type="text"/> .
<b>6</b> <b>6</b> <b>6</b> <b>M</b>	Rotating a pattern clockwise
<b>6</b> <b>6</b> <b>7</b> <b>M</b>	Rotating a pattern counterclockwise
<b>6</b> <b>7</b> <b>6</b> <b>M</b>	Copying a pattern clockwise
<b>6</b> <b>7</b> <b>7</b> <b>M</b>	Copying a pattern counterclockwise
<b>8</b> <b>8</b> <b>8</b> <b>M</b>	Resizing a pattern. Input the magnification in the X direction by <input type="text"/> <input type="text"/> <input type="text"/> <b>F</b> , and in the Y direction by <input type="text"/> <input type="text"/> <input type="text"/> <b>M</b> .
<b>9</b> <b>9</b> <b>9</b> <b>M</b>	Resizing and copying a pattern. Input the magnification in the X direction by <input type="text"/> <input type="text"/> <input type="text"/> <b>F</b> , and in the Y direction by <input type="text"/> <input type="text"/> <input type="text"/> <b>M</b> .
<b>3</b> <b>3</b> <b>3</b> <b>L</b>	Repeated copying
<b>4</b> <b>4</b> <b>0</b> <b>L</b>	Copying a pattern symmetrically to a point
<b>4</b> <b>4</b> <b>1</b> <b>L</b>	Copying a pattern symmetrically to the X axis
<b>4</b> <b>4</b> <b>2</b> <b>L</b>	Copying a pattern symmetrically to the Y axis

4 4 3 L	Copying in the reverse direction
7 7 7 L	Moving data in parallel before the current needle position (changing the moving amount data of the needle position)
L 7 7 7 L	Moving data in parallel after the current needle position (using needle drop data to the moved position)

## Setting attribute

1 <input type="checkbox"/> <input type="checkbox"/> L	Setting the number of feed boundaries to be ignored (0 - 99)
2 3 0 L	Stopping the needle at the upper end (only when the needle position is at split)
2 3 1 L	Stopping the needle at the lower end (only when the needle position is at split)
6 6 6 L	The maximum sewing speed becomes 400 rpm or lower.
6 6 7 L	The maximum sewing speed becomes 1200 rpm or lower.
6 6 8 L	The maximum sewing speed becomes 800 rpm or lower.
6 6 9 L	The maximum sewing speed becomes 600 rpm or lower.
6 6 0 L	Cancels low speed data setting
7 7 1 L	Turns on option output 1.
7 7 2 L	Turns on option output 2.
7 7 3 L	Turns on option output 3.
7 7 0 L	Turn off all option outputs.
9 8 0 L	Not breaking thread for feed (only when the needle position is at feed)
9 8 1 L	Breaks thread for feed (only when the needle position is at feed)

## Other operations

ESC	Returning from pattern image to the setting screen. Returning from error message to the previous screen.
	Displaying data image
	Turning on (off) the programmer
	Canceling command

## Programming example

Frequently used programming method is explained here. Refer to "Programming" (page 163) for function and operation of each icon.

### Programming for each stitch

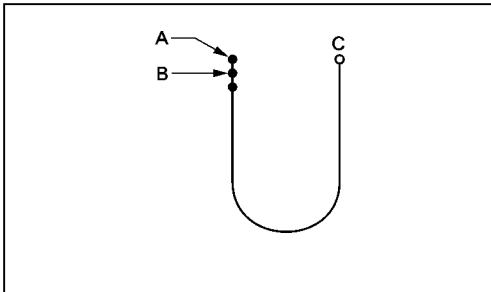

Program each stitch according to the pattern. The example in the left is used for explanation.

### Programming

1. Press **P**.  
The work clamp moves to the home position and the programmer screen is displayed.
2. Move the work clamp with **▲▼◀▶**. Press **L** when the needle point is at point A of the pattern.  
The first stitch (point A) is programmed.
3. Repeat step 2 and create the program to point C.

### Inputting the end code

1. Press **L** at the last stitch and press **1 1 1 E**.  
The work clamp returns to the start position.

### Saving

1. Specify the program number on the operation panel and press the read/write switch for writing into the floppy disk.



### Ending program

1. Press **P**.

### Resizing input

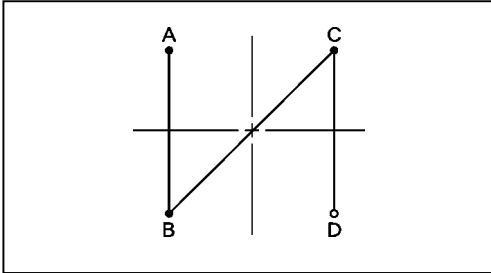

Resizing input is used to program a detailed pattern stitch by stitch. The example in the left is used for explanation on of programming the pattern to the magnification of 5.

### Programming

1. Press **P**.  
The work clamp moves to the home position and the programmer screen is displayed.

2. Press **9 0 5 M**.  
**9**   is the command for resizing input.  
Input the magnification (02, 05, 10) in  .



3. Move the work clamp with **Δ ∇ ◀ ▶**. Press **L** when the needle point is at point A of the pattern.  
The first stitch (point A) is programmed.
4. Repeat step 3 and create the program to point D.

### Inputting the end code

1. Press **L** at the last stitch and press **1 1 1 E**.  
The work clamp returns to the start position.



### Saving

1. Specify the program number on the operation panel and press the read/write switch for writing into the floppy disk.

## Ending program

1. Press **P**.

## Lines

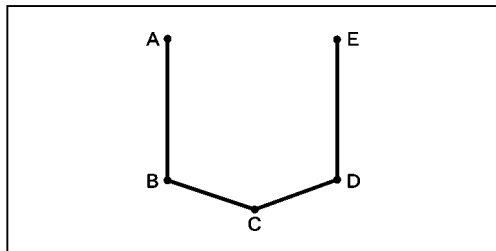

The pattern with lines is programmed.  
The example in the left is used for explanation of programming.

## Programming

1. Press **P**.  
The work clamp moves to the home position and the programmer screen is displayed.
2. Move the work clamp with **Δ▽◀▶**. Press **L** when the needle point is at point A of the pattern.  
The first stitch (point A) is programmed.
3. Input the stitch length.  
3.0 mm is input in the example.  
Input 030 to make the stitch length to 3.0 mm.
4. Press **LI**.  
To change the stitch length, specify the pitch value before pressing **LI**.
5. Move the work clamp with **Δ▽◀▶**. Press **L** when the needle point is at point B of the pattern.
6. Repeat steps 4 and 5 and create the program to point E.

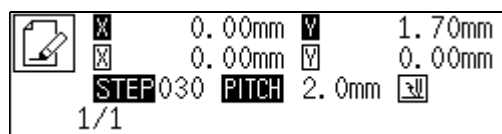

## Inputting the end code

1. Press **L** at the last stitch and press

**1 1 1 E**.

The work clamp returns to the start position.

## Saving

1. Specify the program number on the operation panel and press the read/write switch for writing into the floppy disk.

## Ending program

1. Press **P**.

## Curve

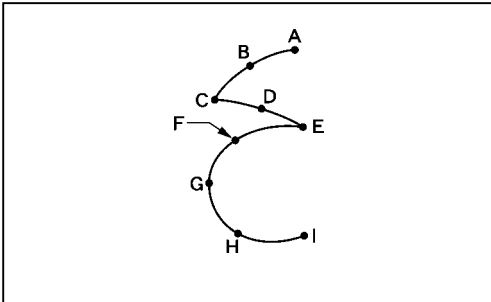

A pattern with curves is programmed.

Be sure to press **7** **8** **9** **L** for a split at corner points C or E. If a split is not made, the corner will be round.

When a split is made

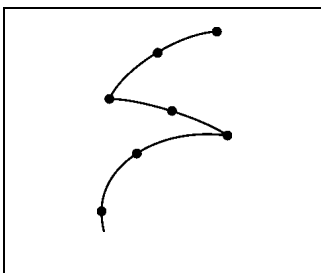

When a split is not made

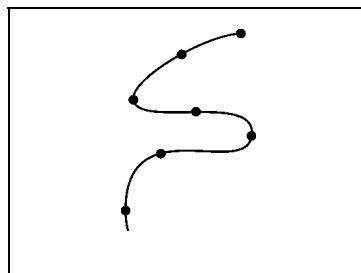

More intermediate points such as points B, D, F or G will create smooth curves.

## Programming

1. Press **P**.  
The work clamp moves to the home position and the programmer screen is displayed.
2. Move the work clamp with **Δ** **▽** **◀** **▶**. Press **L** when the needle point is at point A of the pattern.  
The first stitch (point A) is programmed.

3. Input the stitch length and press **M**.  
3.0 mm is input in the example.  
Input 030 to make the stitch length to 3.0 mm.



4. Move the work clamp with **Δ▽◀▶**. Press **L** when the needle point is at point B of the pattern.



5. Move the work clamp with **Δ▽◀▶**. Press **7 8 9 L** when the needle point is at point C of the pattern.  
Point C becomes a sharp corner. The range from points A to C is programmed.



6. Press **M**.  
To change the stitch length, specify the pitch value before pressing **M**.
7. Move the work clamp with **Δ▽◀▶**. Press **L** when the needle point is at point D of the pattern.
8. Repeat step 7 and create the program to point E.
9. Press **7 8 9 L** as in step 5.  
The range from points C to E is programmed.
10. Create the program to point I in the similar manner.

### Inputting the end code

1. Press **1 1 1 E**.  
The work clamp returns to the start position.

### Saving

1. Specify the program number on the operation panel and press the read/write switch for writing into the floppy disk.

## Ending program

1. Press **P**.

## Double stitch

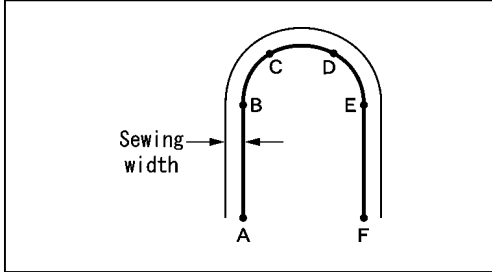

A double stitch is programmed to make two lines with a constant width. The example in the left is used for explanation of a double stitch to the left of sewing direction.

When the line changes from straight to curve or curve to straight as in points B or E, be sure to press **7 8 9 L** to make a split.

More intermediate points such as points C or D will create smooth curves.

## Programming

1. Press **P**.  
The work clamp moves to the home position and the programmer screen is displayed.
2. Move the work clamp with **Δ ▽ ◀ ▶**. Press **L** when the needle point is at point A of the pattern.  
The first stitch (point A) is programmed.

3. Press **2 3 0** and press **M**.  
**2 0 0** is the command for the double stitch. Input the width of the double stitch in **0 0**. 3.0 mm is input in the example.



4. Input the stitch length and press **M**.  
3.0 mm is input in the example.  
Input 030 to make the stitch length to 3.0 mm.



5. Create the program to point F in the similar manner of curve program.  
If a straight line is present as in the example, press **7 8 9 L** at the end of the line.

## Inputting the end code

1. Press **L** at the last stitch and press

**1** **1** **1** **E**.

The needle moves to points G and H.

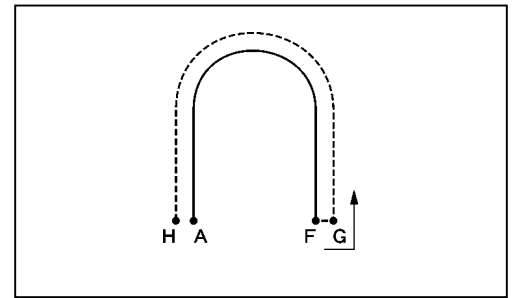

## Saving

1. Specify the program number on the operation panel and press the read/write switch for writing into the floppy disk.

## Ending program

1. Press **P**.

## Feed

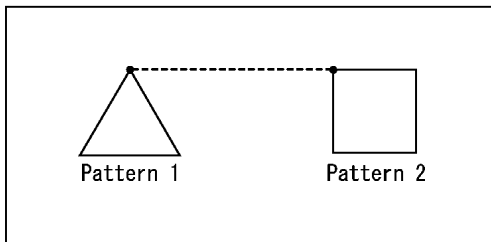

After thread breaking, a feed is set for continuous sewing with the work clamp in position.

The example in the left is used for explanation of programming pattern 2 with a feed after pattern 1.

## Programming

1. Press **P**.

The work clamp moves to the home position and the programmer screen is displayed.

2. Move the work clamp with **▲▼◀▶**. Press **L** when the needle point is at point A of the pattern.

The first stitch (point A) is programmed.

3. Program pattern 1.

4. Input point B and press **F**.

5. Move the work clamp with **△▽◀▶**. Press **L** when the needle point is at point C of the pattern.

6. Program pattern 2.

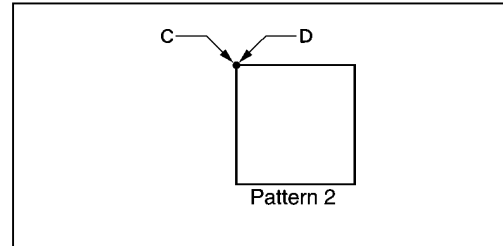
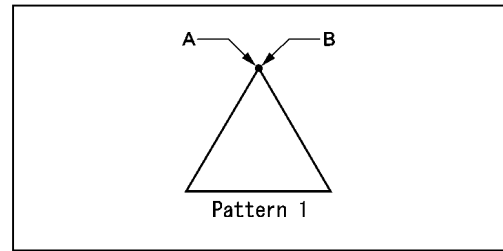

### Inputting the end code

1. Press **L** at the last stitch and press

**1 1 1 E**.

The work clamp returns to the start position.

### Saving

1. Specify the program number on the operation panel and press the read/write switch for writing into the floppy disk.

### Ending program

1. Press **P**.

## Basting

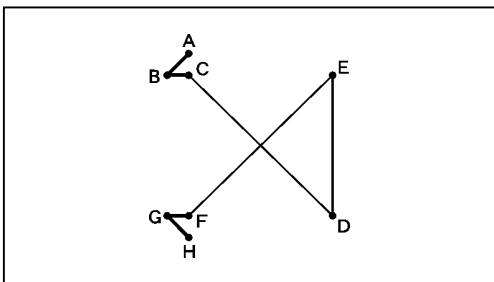

Basting is programmed. The example in the left is used for explanation of basting programming from point C to point F.

### Programming

1. Press **P**.  
The work clamp moves to the home position and the programmer screen is displayed.
2. Move the work clamp with **Δ▽◀▶**. Press **L** when the needle point is at point A of the pattern.  
The first stitch (point A) is programmed.
3. Repeat step 2 and create the program to point C.

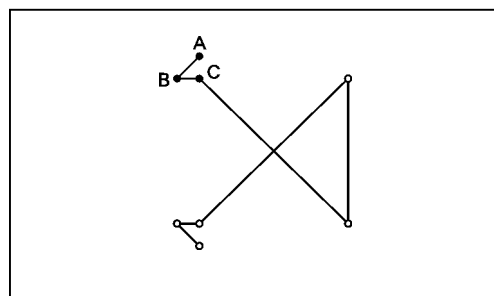

4. Input point C and press **9 9 9 F**.  
Input the basting command.



5. Move the work clamp with **Δ▽◀▶**. Press **L** when the needle point is at point D of the pattern.
6. Repeat steps 4 and 5 and create the program to point F.
7. Create the program to points G and H as in step 2.



### Inputting the end code

1. Press **L** at the last stitch and press

**1 1 1 E**.

The work clamp returns to the start position.

### Saving

1. Specify the program number on the operation panel and press the read/write switch for writing into the floppy disk.

### Ending program

1. Press **P**.

### Symmetrical pattern

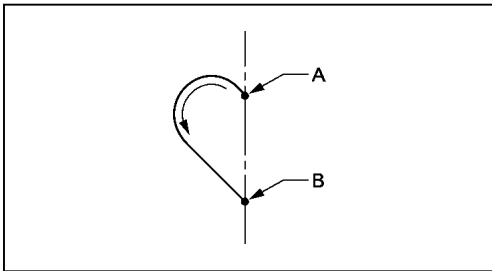

A pattern symmetric to the X axis or the Y axis is programmed. After programming the pattern, select the symmetrical pattern type to complete the pattern. The example in the left is used for explanation of programming symmetric to the Y axis.

The following symmetrical pattern types are available:

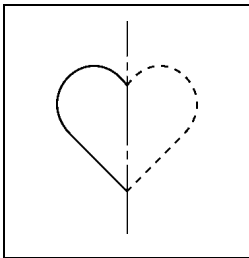

Symmetric to Y axis

Use command **4 4 2 L**.

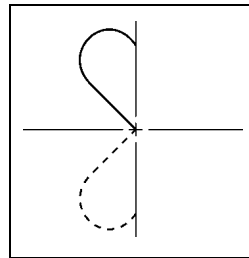

Symmetric to X axis

Use command **4 4 1 L**.

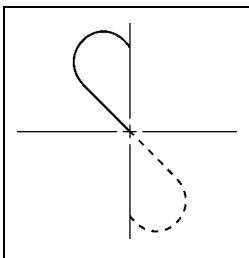

Symmetric to point

Use command **4 4 0 L**.

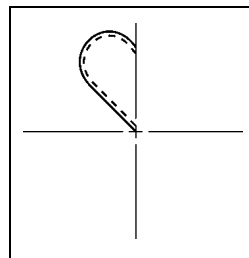

Turnover

Use command **4 4 3 L**.

## Programming

1. Press **P**.  
The work clamp moves to the home position and the programmer screen is displayed.
2. Move the work clamp with **△▽◀▶**. Press **L** when the needle point is at point A of the pattern.  
The first stitch (point A) is programmed.
3. Create the program to point B.
4. Input point B and press **4 4 2 L**.  
Input the command symmetric to Y axis.
5. The needle point moves slowly from point B to point A in the right half and it is automatically programmed. Press **+** to make fast movement.

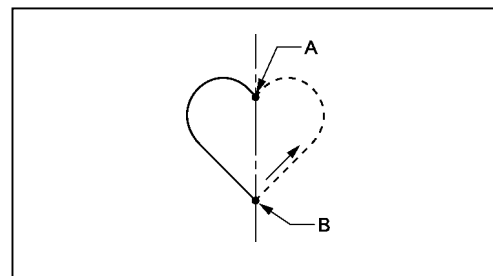
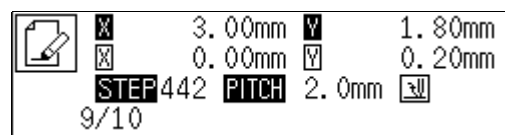

## Inputting the end code

1. Press **1 1 1 E** when needle stops at point A.  
The work clamp returns to the start position.

## Saving

1. Specify the program number on the operation panel and press the read/write switch for writing into the floppy disk.

## Ending program

1. Press **P**.

## Splitting

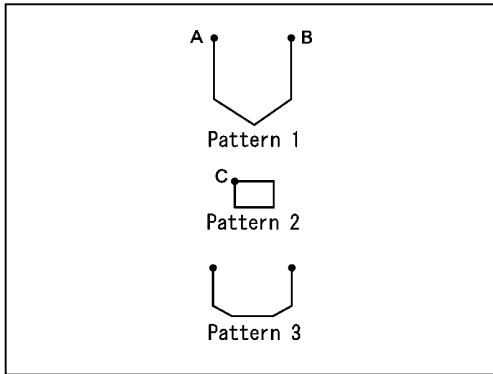

Different patterns, splitting each pattern in sequence, are programmed. The example in the left is used for explanation of 3 patterns in sequence.

## Programming

1. Press **P**.  
The work clamp moves to the home position and the programmer screen is displayed.
2. Move the work clamp with **▲▼◀▶**. Press **L** when the needle point is at point A of the pattern.  
The first stitch (point A) is programmed.
3. Program pattern 1.
4. Input point B and press **F**.
5. Move the work clamp with **▲▼◀▶**. Press **6 6 6 L** when the needle point is at point C of the pattern.  
To change the pattern, press the pressure holder lift switch and replace the pattern.
6. Program patterns 2 and 3.

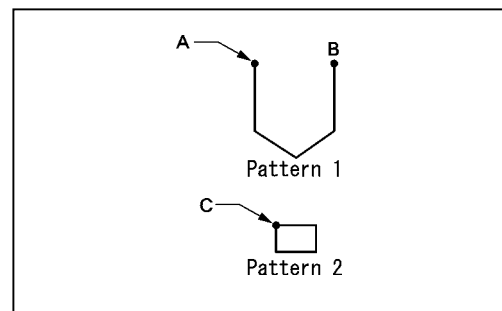

## Inputting the end code

1. Press **L** at the last stitch and press **1 1 1 E**.  
The work clamp returns to the start position.

## Saving

1. Specify the program number on the operation panel and press the read/write switch for writing into the floppy disk.

## Ending program

1. Press **P**.

## Zigzag stitch

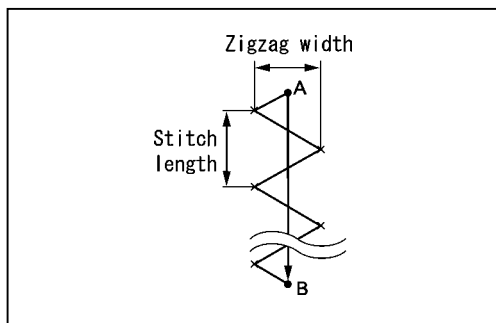

Zigzag stitch is programmed. The example in the left is used for explanation of even width of zigzag stitch on the sewing path.

Zigzag with curves may be programmed.

## Programming

1. Press **P**.

The work clamp moves to the home position and the programmer screen is displayed.

2. Move the work clamp with **△▽◀▶**. Press **L** when the needle point is at point A of the pattern.

The first stitch (point A) is programmed.

3. Press **7 3 0** and press **M**.

**7** is the command for the zigzag stitch. Input the width of the zigzag stitch in . 3.0 mm is input in the example.



4. Input the stitch length and press **M**.

3.0 mm is input in the example. Input 030 to make the stitch length to 3.0 mm.



5. Move the work clamp with **△▽◀▶**. Press **7 8 9 L** when the needle point is at point B of the pattern.

Zigzag stitch with even width to the left and the right is programmed.



## Inputting the end code

1. Press **1** **1** **1** **E**.

The work clamp returns to the start position.

## Saving

1. Specify the program number on the operation panel and press the read/write switch for writing into the floppy disk.

## Ending program

1. Press **P**.

## Multiple stitch

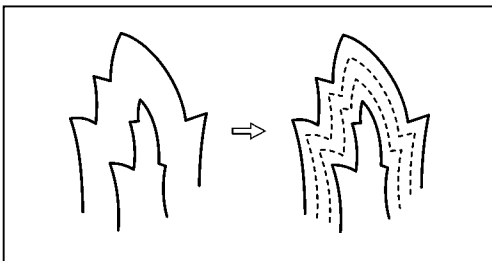

This section describes programming of a multiple stitch. Refer to the example on the left.

Programming can be started from either inside or outside line. Embroidering is carried out in the sequence of programming.

Embroidering direction depends on programming sequence.

When embroidering direction should be changed at a sharp angle, a split should be provided in the vicinity of the direction change point for finishing the multiple stitch in relatively uniform conditions.

Up to 200 points can be specified for one side. If you attempt to input 201 or more points, the needle point is automatically returned to the previous points. In that case, start inputting points of outside (or the inside) line, or reconsider point position or pattern.

## Creating a stitch pattern

1. Create a pattern in consideration off the most inside and outside lines for a multiple stitch.

The two lines should be spaced uniformly.

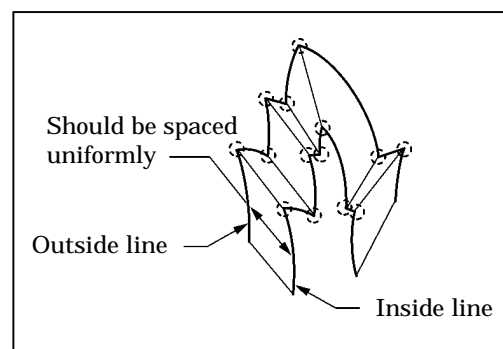

2. Connect each direction change point on the inside line with the matched direction change point on the outside line using a line.

3. Provide one point (or more points) between the above two direction change points, and connect them using a line.

Follow the procedure for curve points specification. Specify points in pairs on the inside and outside lines. The lines should be spaced uniformly.

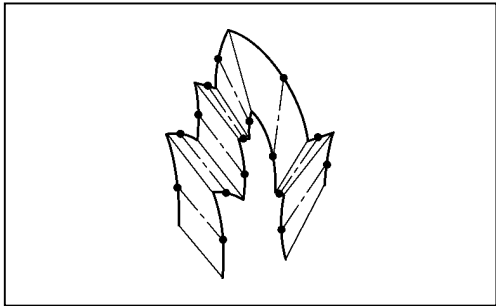

Programming

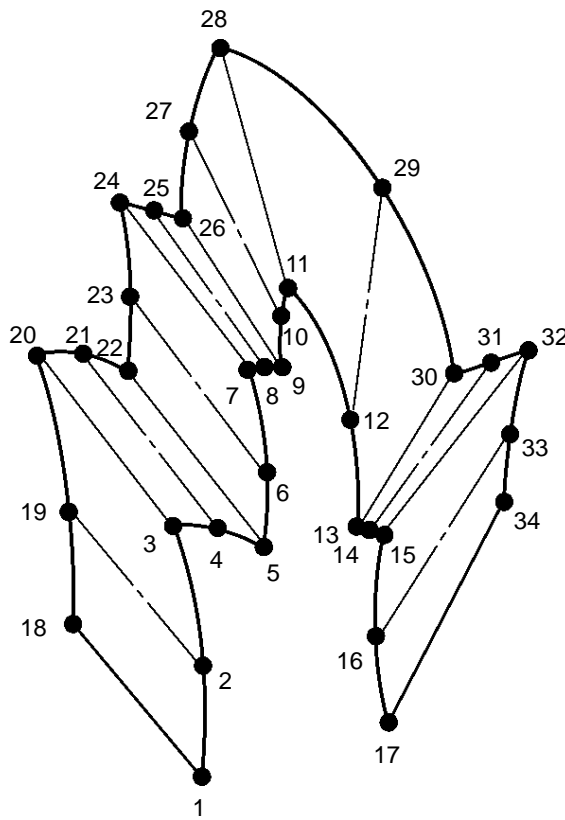

1. Press **P**.  
The work clamp moves to the home position and the programmer screen is displayed.

2. Move the work clamp with **Δ▽◀▶**. Press **L** when the needle point is at point 1 of the pattern.  
The first stitch (point 1) is programmed.

3. Press **500** and **M**.



4. Move the work clamp with  $\Delta \nabla \triangleleft \triangleright$ . Press **L** when the needle point is at point 2 of the pattern.

5. Move the work clamp with  $\Delta \nabla \triangleleft \triangleright$ . Press **7 8 9 L** when the needle point is at point 3 of the pattern.

Be sure to press **7 8 9 L** for a split at a corner like point 3. If a split is not made, the corner will be round.

6. Program the following points up to point 17 with the curve programming steps.

When there is a liner section, move the needle point from the split to the next split, and press

**7 8 9 L**.

In the example, a linear line is programmed between points 7 and 9. Be sure to program a linear line also for the matched section between points 24 and 26.

By pressing **0 -**, the needle point is returned to the previous point. It cannot be returned beyond the previous split.

By pressing **1 -**, the needle point is returned to the previous split. However, when the needle point is at a split, it cannot be moved.

By pressing **2 -**, the needle point is returned to the split before the previous split.

7. Press **F**. Move the work clamp with  $\Delta \nabla \triangleleft \triangleright$ . Press **L** when the needle point is at point 18 of the pattern.

8. Program the following points up to point 34 in the same manner.

When programming, be sure that the points and splits specified on the inside line are paired with those on the outside line respectively.

If there are any points or splits not paired, the needle automatically returns to the previous point. Correct the program.

9. Press **5** and **M**.

Input the number of lines for a multiple stitch in **□□**.

When the number should be "5", input "505".

10. Input the stitch length. Press **M**.

"3.0 mm" is input in the example. Input "030" to make the stitch length to 3.0 mm.



11. Press **L**.

If the number of lines for a multiple stitch has not been input, a buzzer sounds. Repeat step 9.

### Inputting the end code

1. Press **1 1 1 E**.

The work clamp returns to the start position.

### Saving

1. Specify the program number on the operation panel and press the read/write switch for writing into the floppy disk.

### Ending program

1. Press **P**.



## Example of modified program

This section describes the modification method of the program using examples. Refer to "Programming" (page 163).

### Resizing pattern

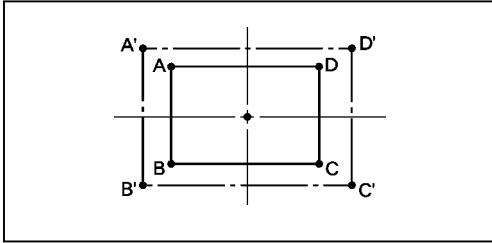

The programmed pattern is resized. The example in the left is used for explanation.

The center point (reference point) of resizing can be changed. The magnifying direction varies depending on the position of the reference point.

If the reference point is not determined, the pattern is resized to the home position.

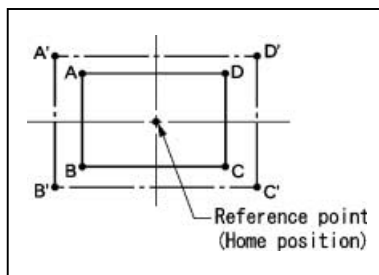

If the reference point is determined, the pattern is resized to the reference point.

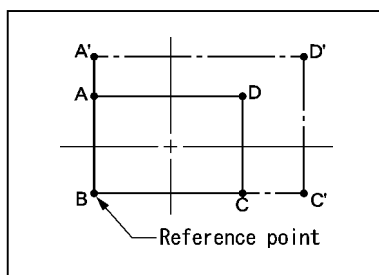

### Calling data

1. Specify the program number on the operation panel and press the read/write switch to read the data.

## Resizing

1. Move the needle to the reference point of resizing with  $\Delta \nabla \leftarrow \rightarrow$ .

The pattern is resized to the home position if the needle is not moved.

2. Press  $\boxed{8} \boxed{8} \boxed{8}$  and press  $\text{M}$ .  
Input the resizing command.

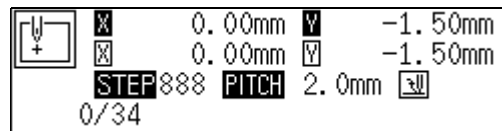

3. Press  $\boxed{1} \boxed{5} \boxed{0}$  and press  $\text{F}$ .  
Input the resizing percentage for the X axis. Specify the magnification percentage by 3 digits in  $\boxed{\phantom{000}}$ . 150% is specified in the example.

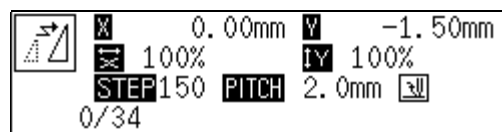

4. Press  $\boxed{1} \boxed{5} \boxed{0}$  and press  $\text{M}$ .  
Input the resizing percentage for the Y axis. Specify the magnification percentage by 3 digits in  $\boxed{\phantom{000}}$ . 150% is specified in the example.

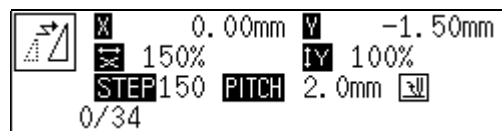

5. Input the stitch length. Press  $\text{L}$ .  
If the stitch length is 0.0, the pattern is resized with the same number of stitches as the original data.

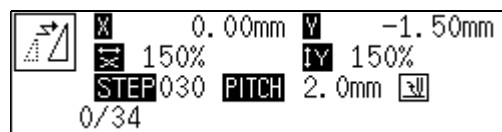

## Saving

1. Specify the program number on the operation panel and press the read/write switch for writing into the floppy disk.

## Ending program

1. Press  $\text{P}$ .

## Changing partially

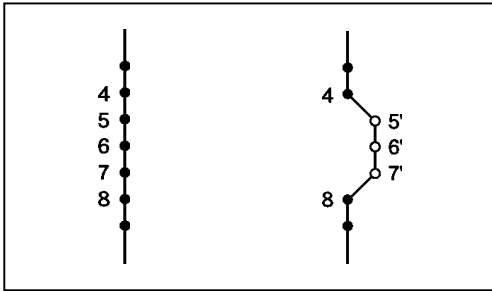

A part of the programmed pattern is changed. The example in the left is used for explanation of creating 5', 6' and 7'.

### Calling data

1. Specify the program number on the operation panel and press the read/write switch to read the data.

### Moving to position 4.

1. Press **9** **9** **9** and press **+**.  
The work clamp moves from the start position by each stitch.



2. When the needle point reaches 4, press **-**.  
The work clamp stops. If the work clamp passes, input a few stitches and press **-**. The needle returns for a few stitches of the input.

### Programming a new point.

1. Move the work clamp with **Δ** **▽** **◀** **▶**. Press **L** when the needle point is at 5'. 5' is programmed.
2. Repeat step 1 and program 6' and 7'.

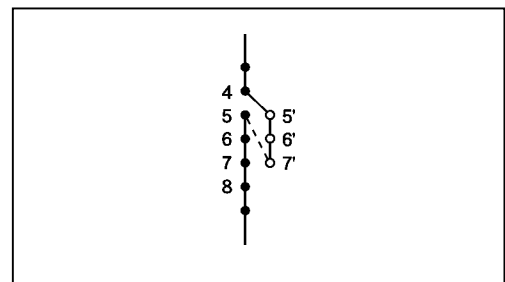

3. Press **1** and press **+**.  
The needle point moves to 5.

## Deleting unnecessary points

1. Press **C**.
2. Input the number of stitches to be deleted and press **+**.  
The example is deleting 3 stitches ahead. Press **3** **+**.
3. The needle point moves to 6, 7 and 8. Points 5, 6 and 7 are deleted.

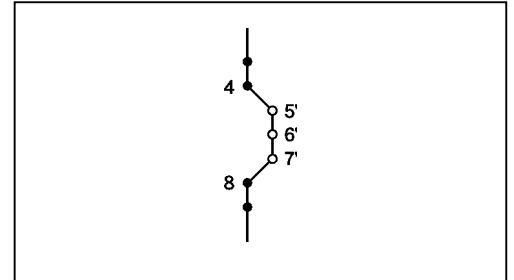

## Saving

1. Specify the program number on the operation panel and press the read/write switch for writing into the floppy disk.

## Ending program

1. Press **P**.

## Deleting the first stitch

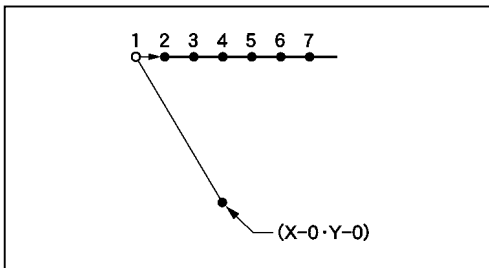

The first stitch of the programmed pattern is deleted. The example in the left is used for explanation of deleting 1 and setting 2 for the sewing start position.

## Calling data

1. Specify the program number on the operation panel and press the read/write switch to read the data.

### Moving to position 1.

1. Press **1** and press **+**.  
The work clamp moves to the start position.

### Deleting 1

1. Press **C**.
2. Input the number of stitches to be deleted and press **+**.  
The example is deleting 1 stitch ahead.  
Press **1** **+**.

3. The needle point moves to 2.

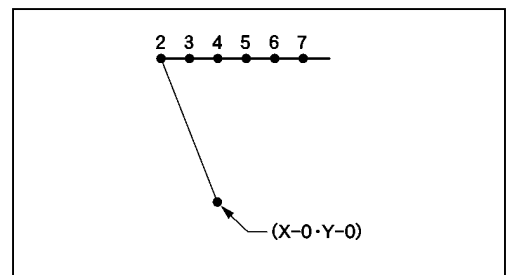

### Saving

1. Specify the program number on the operation panel and press the read/write switch for writing into the floppy disk.

### Ending program

1. Press **P**.

## Changing the first stitch position

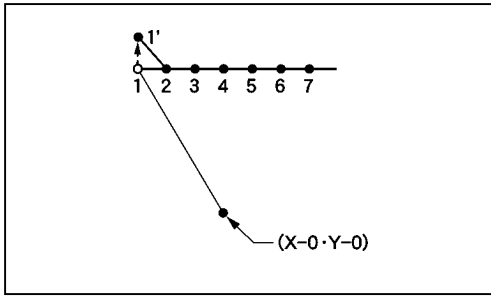

The position of the sewing start position is changed. The example in the left is used for explanation of moving the sewing start position from 1 to 1'.

### Calling data

1. Specify the program number on the operation panel and press the read/write switch to read the data.

### Moving to position 1.

1. Press **1** and press **+**.  
The work clamp moves to the start position.

### Programming a new point.

1. Move the work clamp with **Δ▽◀▶**. Press **L** when the needle point is at 1' of the pattern.  
1' is programmed.

### Deleting 1

1. Press **1** and press **-**.  
The needle point returns to the first stitch.
2. Press **C**.
3. Input the number of stitches to be deleted and press **+**.  
The example is deleting 1 stitch. Press **1** **+**.

- The needle point moves to 1'.

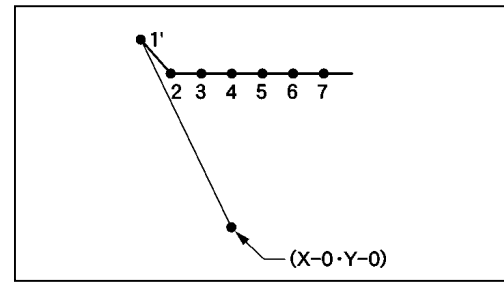

### Saving

- Specify the program number on the operation panel and press the read/write switch for writing into the floppy disk.

### Ending program

- Press **P**.

### Adding sewing point before the first stitch

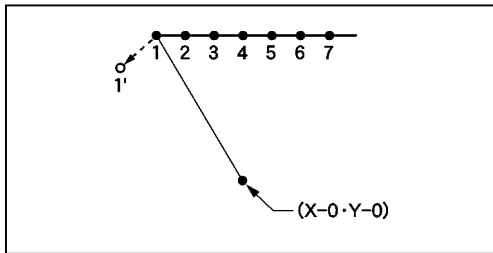

A point is added before the current sewing point to change the sewing start position. The example in the left is used for explanation of changing the sewing start position from 1 to 1'.

### Calling data

- Specify the program number on the operation panel and press the read/write switch to read the data.

### Moving to position 1.

- Press **1** and press **+**.  
The work clamp moves to the start position.

### Programming a new point.

1. Press **F**.
2. Move the work clamp with **Δ▽◀▶** so that the needle point is at 1' of the pattern.  
Record the coordinates (values of **X** and **Y**).
3. Press **L**.  
1' is programmed.
4. Move the work clamp with **Δ▽◀▶** to the opposite position of coordinates recorded in step 2 and press **L**.  
If the moving distance is long, press **LI**.
5. Press **R**.  
The work clamp returns to the home position.

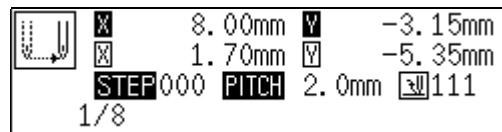

### Deleting 1

1. Press **1** and press **+**.  
The needle point returns to the first stitch.
2. Press **C**.
3. Input the number of stitches to be deleted and press **+**.  
The example is deleting 1 stitch. Press **1** **+**.
4. The needle point moves to 1'.

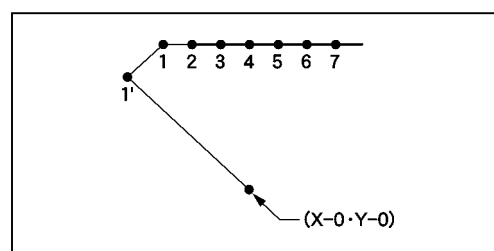

### Saving

1. Specify the program number on the operation panel and press the read/write switch for writing into the floppy disk.

### Ending program

1. Press **P**.



## Adding escape point before the first stitch

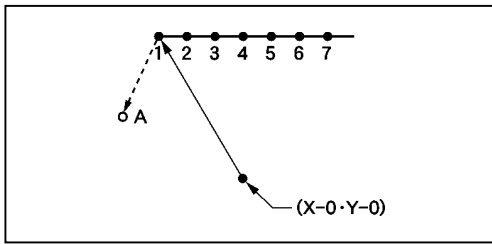

An escape point is added before the sewing start position. The example in the left is used for explanation of setting escape point A.

The escape point is a provisional point provided for prevention of the work clamp interference with the needle or the bar leg when the work clamp is lifted at the start point.

### Calling data

1. Specify the program number on the operation panel and press the read/write switch to read the data.

### Moving to position 1.

1. Press **1** and press **+**.  
The work clamp moves to the start position.

### Programming a new point.

1. Press **F**.
2. Move the work clamp with **Δ▽◀▶** so that the needle point is at A of the pattern.  
Record the coordinates (values of **X** and **Y**).
3. Press **L**.  
A is programmed.
4. Press **F**.
5. Move the work clamp with **Δ▽◀▶** to the opposite position of coordinates recorded in step 2 and press **L**.

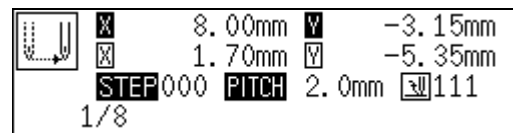

## Deleting 1

1. Press **2** and press **-**.  
The needle point moves to the first stitch, point A and the first stitch.
2. Press **C**.
3. Input the number of stitches to be deleted and press **+**.  
The example is deleting 1 stitch. Press **1** **+**.
4. The needle point moves to A.

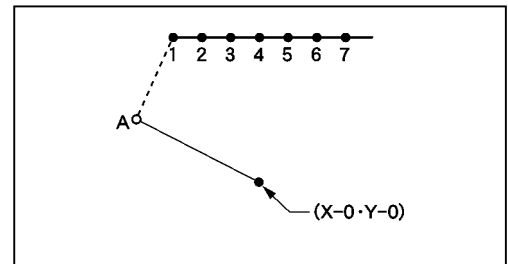

## Saving

1. Specify the program number on the operation panel and press the read/write switch for writing into the floppy disk.

## Ending program

1. Press **P**.

## Moving the escape point

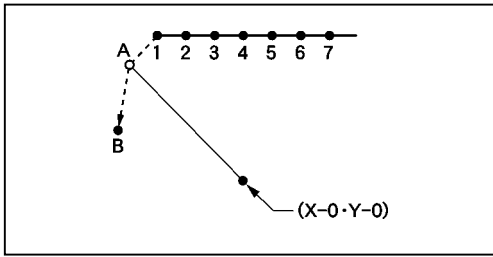

The position of the escape point is moved. The example in the left is used for explanation of moving the escape point from A to B.

### Calling data

1. Specify the program number on the operation panel and press the read/write switch to read the data.

### Moving to position A.

1. Press **1** and press **+**.  
The work clamp moves to the escape point.

### Programming a new point.

1. Press **F**.
2. Move the work clamp with **Δ▽◀▶**. Press **L** when the needle point is at B of the pattern.  
B is programmed.

### Deleting 1

1. Press **1** and press **-**.  
The needle point returns to A.
2. Press **C**.
3. Input the number of stitches to be deleted and press **+**.  
The example is deleting 1 stitch. Press **1+**.

- The needle point moves to B.

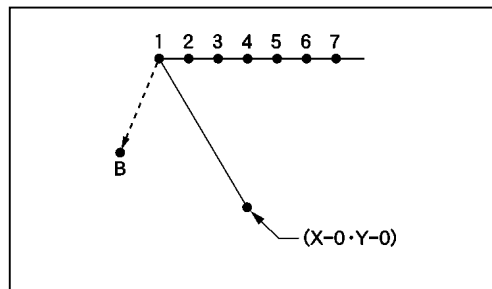

### Saving

- Specify the program number on the operation panel and press the read/write switch for writing into the floppy disk.

### Ending program

- Press **P**.

### Deleting the escape point

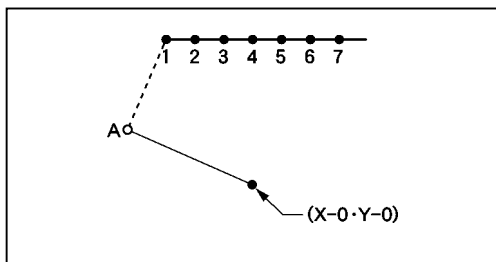

The escape point is deleted. The example in the left is used for explanation of deleting A.

### Calling data

- Specify the program number on the operation panel and press the read/write switch to read the data.

### Moving to position A.

- Press **1** and press **+**.  
The work clamp moves to the escape point.

## Deleting A

1. Press **C**.
2. Input the number of stitches to be deleted and press **+**.  
The example is deleting 1 stitch. Press **1** **+**.
3. The needle point moves to 1.

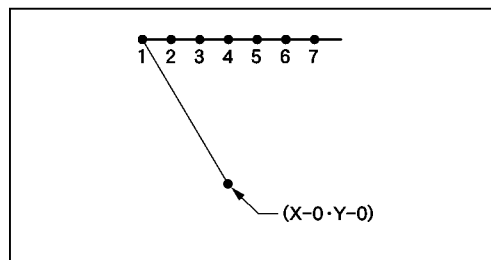

## Saving

1. Specify the program number on the operation panel and press the read/write switch for writing into the floppy disk.

## Ending program

1. Press **P**.

## Moving the pattern in parallel 1

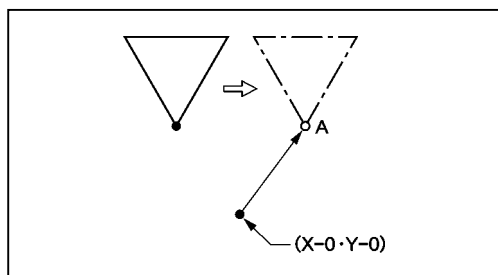

The program data is moved in parallel. The example in the left is used for explanation of moving the pattern in parallel when the first stitch is the sewing start position.

## Calling data

1. Specify the program number on the operation panel and press the read/write switch to read the data.

### Moving in parallel

1. Move the work clamp with  $\Delta \nabla \triangleleft \triangleright$ . Press **L** when the needle point is at A of the pattern.

### Saving

1. Specify the program number on the operation panel and press the read/write switch for writing into the floppy disk.

### Ending program

1. Press **P**.

### Moving the pattern in parallel 2

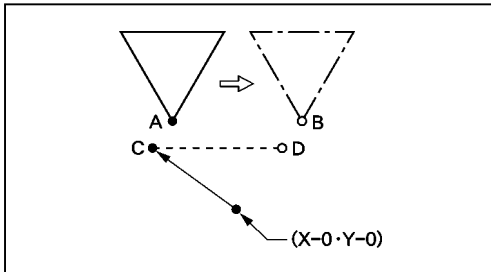

The program data is moved in parallel. The example in the left is used for explanation of moving the pattern in parallel when the first stitch is the escape point.

### Calling data

1. Specify the program number on the operation panel and press the read/write switch to read the data.

### Moving

1. Press **2** and press **+**.  
The needle point moves to point A.

2. Move the work clamp with  $\Delta \nabla \triangleleft \triangleright$  so that the needle point is at B of the pattern.  
Record the coordinates (values of  $X$  and  $Y$ ).  
If the moving distance is long, press **F** before movement.



3. Press **R**.  
The work clamp moves to the home position.
4. Press **1** and press **+**.  
The needle point moves to point C.
5. Move the work clamp with  $\Delta \nabla \triangleleft \triangleright$  for the coordinates recorded in step 2.  
The moved point is now D.  
If the moving distance is long, press **F** before movement.
6. Turn the pulley with a hand and put a marking with the needle to indicate the position of point D.
7. Turn the pulley with a hand and move the needle to the top point.
8. Press **R**.  
The work clamp returns to the home position.
9. Move the work clamp with  $\Delta \nabla \triangleleft \triangleright$ . Press **L** when the needle point is at D of the pattern.

### Saving

1. Specify the program number on the operation panel and press the read/write switch for writing into the floppy disk.

### Ending program

1. Press **P**.

## Deleting a part of the program during programming

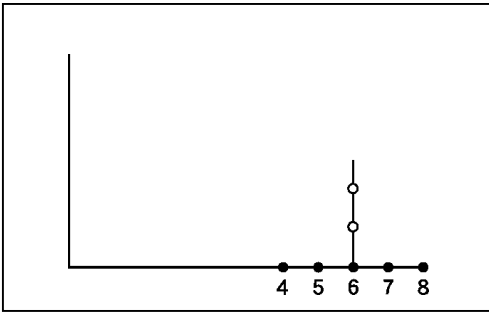

A program can be modified during programming. The example in the left is used for explanation of deleting 2 stitches at 8 and creating a new program.

1. Press **C**.
2. Input the number of stitches to be deleted and press **-**.  
The example is deleting 2 stitches backward.  
Press **2** **-**.
3. The needle point moves to 6.

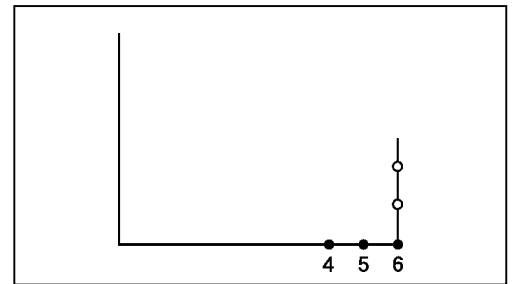

4. Continue programming.

## Moving a part of continuous program in parallel

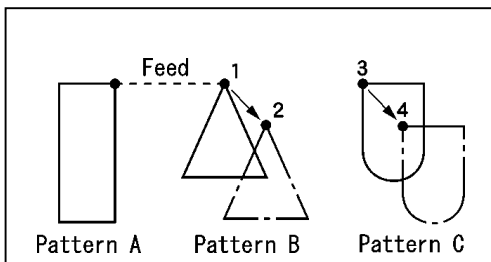

A part of continuous program is moved in parallel. The example in the left is used for explanation of moving patterns B and C in parallel.

## Calling data

1. Specify the program number on the operation panel and press the read/write switch to read the data.



## Moving to position 1

1. Press **9****9****9** and press **+**.  
The work clamp moves from the start point by each stitch.
2. Press **-** when the needle is at 1.  
The work clamp stops. If the work clamp passes, input a few stitches and press **-**. The needle returns for a few stitches of the input.

## Moving in parallel

1. Press **7****7****7** and press **F**.  
Input the command for parallel movement.

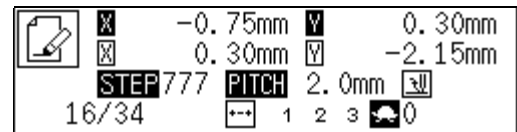

2. Move the work clamp with **Δ▽◀▶**. Press **L** when the needle point is at 2 of the pattern.  
If pattern C is present after pattern B, pattern C is automatically moved in parallel. If this is not preferred, move pattern C in parallel as in steps "Moving to position 1" and "Moving in parallel" or "Moving a part of continuous program in parallel partially" in chapter 2.

## Saving

1. Specify the program number on the operation panel and press the read/write switch for writing into the floppy disk.

## Ending program

1. Press **P**.

## Canceling thread breakage at the last stitch

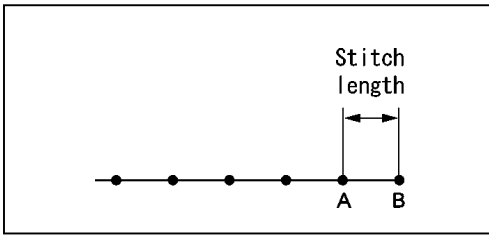

Addition of feed after the last point can cancel thread breakage at the last stitch.

When "115" is input for the end code, the thread breakage does not occur. In this case, every thread breakage including emergency stop is canceled. Carry out the following setting for canceling thread breakage at the specified point.

### Programming

1. Create the program 1 stitch (A) before the desired end point.

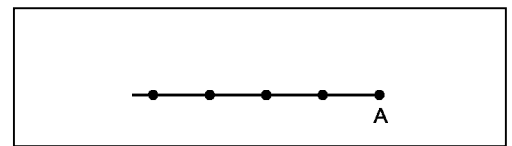

2. Press **9****9****9** and press **F**.
3. Move the work clamp with **Δ****▽****◀****▶** for the stitch length. Press **L** when the needle point is at point B of the pattern. Point B is programmed.
4. Press **F**.
5. Move the work clamp with **Δ****▽****◀****▶**. Press **L** when the needle point is at given point C.

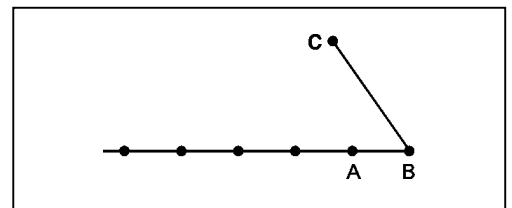

### Inputting the end code

1. Press **L** and press **1****1****1****E**.

## Saving

1. Specify the program number on the operation panel and press the read/write switch for writing into the floppy disk.

## Ending program

1. Press **P**.

# Programming

## Creating a line

Command to be used

□□□ **L**      Input the stitch length in □□□.

Example	Pitch	Input
	0.5 mm	005
	12.0 mm	120

1. Select the sewing start position with **Δ▽◀▶** and press **L**.



2. Input the stitch length in 3 digits and press **L**.



3. Move the needle with **Δ▽◀▶** and press **L**.



## Creating a curve

Command to be used

**M**      Input the stitch length in   .

Example	Pitch	Input
	0.5mm	005
	12.0mm	120

**L**      This command represents completing creation of a curve.

Increase the number of plotting points to create a smoother curve.  
One to 99 points are available for plotting.

1. Select the start point with **▲▼◀▶** and press **L**.



2. Input the stitch length in 3 digits and press **M**.



3. Move the needle with **▲▼◀▶** and press **L**.



4. Input    **L** at the end position of the needle.



## Creating a circle (zigzag circle) by specifying 3 points

Command to be used

Input the overlap stitch counts in  Values 0 - 9 are available for input.

Input this command to create a zigzag circle. Input the zigzag width in .

The zigzag width can be specified from 1.0 - 25.5 mm.

To specify the width of 10.0 mm or more, input  and input the width in 3 digits, then press .

Example:

Pitch

Input

3.5mm

18.0mm

Input this command to create a zigzag circle. Input the zigzag stitch length in .

Example:

Pitch

Input

0.5mm

005

12.0mm

120

1. Select the sewing start position with  and press .



2. Input .



3. Input the stitch length in 3 digits and press .



## Creating a zigzag circle (go to 6 when not creating a zigzag circle)

4. Input  **M** (width).



5. Input the zigzag stitch length in 3 digits and press **M**.



6. Move the needle with **Δ▽◀▶** to select the second point and press **L**.



7. Move the needle with **Δ▽◀▶** to select the third point and press **L**.



## Creating a circle (zigzag circle) by specifying the diameter

Command to be used

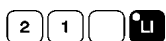

Creating a circle clockwise. Input the overlap stitch counts in [ ]. Values 0 - 9 are available for input.

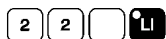

Creating a circle counterclockwise. Input the overlap stitch counts in [ ]. Values 0 - 9 are available for input.

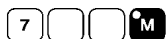

Input this command to create a zigzag circle. Input the width of zigzag in [ ] [ ].  
"Creating a circle (zigzag circle) by specifying 3 points"  
(Refer to page 165.)



Input this command to create a zigzag circle. Input the zigzag stitch length in [ ] [ ] [ ].  
"Creating a circle (zigzag circle) by specifying 3 points" (Refer to page 165.)

1. Select the sewing start position with and press .



2. Input or .



3. Input the stitch length in 3 digits and press .





Creating a zigzag circle (go to 6 when not creating a zigzag circle)

4. Input 7    **M** (width).



5. Input the zigzag stitch length in 3 digits and press **M**.



6. Move the needle with **Δ▽◀▶** to select the second point and press **L**.



Creating a circle (zigzag circle) by specifying the radius

Command to be used

**L**      Creating a circle clockwise. Input the overlap stitch counts in . Values 0 - 9 are available for input.

**L**      Creating a circle counterclockwise. Input the overlap stitchcounts in . Values 0 - 9 are available for input.

**M**      Input this command to create a zigzag circle. Input the width of zigzag in   . "Creating a circle (zigzag circle) by specifying 3 points" (Refer to page 165.)

**M**      Input this command to create a zigzag circle. Input the zigzag stitch length in   . "Creating a circle (zigzag circle) specifying 3 points" (Refer to page 165.)

1. Select the sewing start position with **Δ▽◀▶** and press **L**.



2. Input **2** **3** **□** **□** **L** or **2** **4** **□** **□** **L**.



3. Input the stitch length in 3 digits and press **L**.



Creating a zigzag circle (go to 6 when not creating zigzag circle)

4. Input **7** **□** **□** **M** (width).



5. Input the zigzag stitch length in 3 digits and press **M**.



6. Move the needle with **△** **▽** **◀** **▶** to select the second point and press **L**.



## Creating an arc

Command to be used

**3 0 0 L**

Creating an arc passing 3 points.

1. Select the sewing start position with **Δ▽◀▶** and press **L**.



2. Input **3 0 0 L**.



3. Input the stitch length in 3 digits and press **L**.



4. Move the needle with **Δ▽◀▶** to select the second point, then press **L**.



5. Move the needle with **Δ▽◀▶** to select the third point, then press **L**.





## Creating a semicircle

Command to be used

**3 1 0**  Creating a semicircle clockwise.

**3 2 0**  Creating a semicircle counterclockwise.

1. Select the start position with  and press .





2. Input **3 1 0**  or **3 2 0** .



3. Input the stitch length in 3 digits and press .



4. Move the needle with  to select the second point, then press .



## Creating a zigzag stitch

Command to be used

<b>7</b> <input type="text"/> <input type="text"/> <input type="text"/> <b>M</b>	Input this command to create a zigzag circle. Input the width of zigzag in <input type="text"/> <input type="text"/> . "Creating a circle (zigzag circle) by specifying 3 points" (Refer to page 165.)
<input type="text"/> <input type="text"/> <input type="text"/> <b>M</b>	Input this command to create a zigzag circle. Input the zigzag stitch length in <input type="text"/> <input type="text"/> <input type="text"/> . "Creating a circle (zigzag circle) by specifying 3 points" (Refer to page 165.)
<b>7</b> <b>8</b> <b>9</b> <b>L</b>	Carrying out zigzag stitch symmetrically to the sewing path.
<b>7</b> <b>8</b> <b>8</b> <b>L</b>	Carrying out zigzag stitch on the left side to the sewing path.
<b>7</b> <b>8</b> <b>7</b> <b>L</b>	Carrying out zigzag stitch on the right side to the sewing path.

1. Select the sewing start position with **▲▼◀▶** and press **L**.



2. Input **7**   **M** (width).



3. Input the stitch length in 3 digits and press **M**.



4. Move the needle with **▲▼◀▶** to select the second point, then press **L**.



5. Input **7** **8** **9** **L** at the end position of the needle.

Input **7** **8** **8** **L** for the left side and **7** **8** **7** **L** for the right side.





### Modifying the program of a multiple stitch

When modifying the stitch length or the number of lines for a multiple stitch, the previously created curve program can be used.

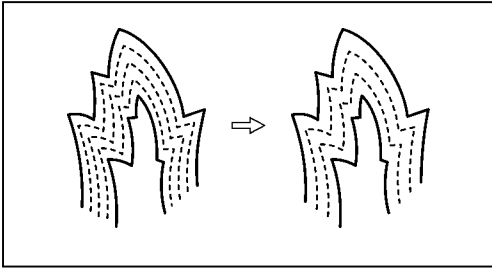

The previously created programs are required for modifying programs of multiple stitch. Programs of multiple stitch written to floppy disks cannot be modified.

#### Commands to be used

<input type="text" value="5"/> <input type="text"/> <input type="text"/> <input type="text"/> M	Input the number of lines for a multiple stitch ranging from 2 to 99 in <input type="text"/> <input type="text"/> .
Ex.)	The number of line for a multiple stitch
	5 lines
	Input value
	505
<input type="text"/> <input type="text"/> <input type="text"/> <input type="text"/> M	Input the stitch length in <input type="text"/> <input type="text"/> <input type="text"/> .

- Press **R**.  
The work clamp moves to the home position.
- Press **9 9 9 +**.  
The needle point moves. When the needle point is at the start point for a multiple stitch, stop it by pressing **-**.
- Input the desired number of lines as **5**M.  

	X	15.15mm	V	-9.80mm
	X	0.15mm	V	-2.95mm
	STEP505		PITCH 3.0mm	
1/60				
- Input the desired stitch length as M.  

	X	15.15mm	V	-9.80mm
	X	0.15mm	V	-2.95mm
	STEP025		PITCH 3.0mm	
1/60				
- Press **L**.  
Calculation is performed based on the input data. When a buzzer stops, the needle point moves to the end point for a multiple stitch.

## Creating double stitch

Command to be used

<input type="text" value="2"/> <input type="text"/> <input type="text"/> <input type="text"/> M	Creating double stitch in the reverse direction to the sewing path. Input the width of double stitch in <input type="text"/> <input type="text"/> . Values 1.0 - 9.9 mm are available for the width.						
	<table border="1"> <thead> <tr> <th>Example</th> <th>Width</th> <th>Input</th> </tr> </thead> <tbody> <tr> <td></td> <td>1.5 mm</td> <td>215</td> </tr> </tbody> </table>	Example	Width	Input		1.5 mm	215
Example	Width	Input					
	1.5 mm	215					
<input type="text"/> <input type="text"/> <input type="text"/> M	Input the stitch length in <input type="text"/> <input type="text"/> <input type="text"/> .						
<input type="text" value="7"/> <input type="text" value="8"/> <input type="text" value="9"/> L	Carrying out double stitch on the left side to the sewing path.						
<input type="text" value="7"/> <input type="text" value="8"/> <input type="text" value="8"/> L	Carrying out double stitch on the right side to the sewing path.						
<input type="text" value="1"/> <input type="text" value="1"/> <input type="text"/> <input type="text"/> E	Starting double stitch calculations. (This is the end code. Refer to page 181 for details.)						

If sharp angles or fine curves are included in the pattern sheet, the desired double stitch may not be achieved.

1. Select the sewing start position with  and press .



2. Determine the width and input M.



3. Move the needle with  to select the second point, then press .



4. Move the needle to the corner point and input L.





5. Repeat steps 3 and 4 and move the needle to the end point. Input **1 1 0 E**.  
 When the alarm sound is complete, the needle point moves to the end position.



## Parallel stitch

Command to be used

**3 0 0 M** Creating parallel stitch in the same direction to the sewing path. Input the width of parallel stitch in **0 0**.  
 Values 1.0 - 9.9 mm are available for the width.

Example	Width	Input
	1.5 mm	315

**0 0 0 M** Input the stitch length in **0 0 0**.

**7 8 9 L** Carrying out parallel stitch on the left side to the sewing path.

**7 8 8 L** Carrying out parallel stitch on the right side to the sewing path.

**1 1 0 E** Starting parallel stitch calculations.  
 (This is the end code. Refer to page 181 for details.)

1. Select the sewing start position with **Δ▽◀▶** and press **L**.



2. Determine the width and input **3 0 0 M**.



3. Move the needle with **Δ▽◀▶** to select the second point, then press **L**.



4. Move the needle to the corner point and input **7 8** **L**.



5. Repeat steps 3 and 4 and move the needle to the end point. Input **1 1** **E**.  
When the alarm sound is complete, the needle point moves to the end position.



## Offset

Command to be used

**4** **M** Creating offset. Input the width of offset stitch in .  
Values 1.0 - 9.9 mm are available for the width.

Example	Width	Input
	1.5 mm	415

**M** Input the stitch length in .

**7 8 9** **L** Carrying out offset on the left side to the sewing path.

**7 8 8** **L** Carrying out offset on the right side to the sewing path.

**1 1** **E** Starting offset calculations.  
(This is the end code. Refer to page 181 for details.)

1. Select the sewing start position with **Δ▽◀▶** and press **L**.



2. Determine the width and input **4** **M**.



3. Move the needle with  $\Delta \nabla \leftarrow \rightarrow$  to select the second point, then press **L**.



4. Move the needle to the corner point and input **7 8** **L**.



5. Repeat steps 3 and 4 and move the needle to the end point. Input **1 1** **E**.  
When the alarm sound is complete, the needle point moves to the end position.



## Creating feed data

Command to be used

**F 6 6 6 L** Specifying split (the separation point for different patterns in sewing) after feed

**F 7 7 7 L** Moving in parallel for the feed

**F 8 8 8 L** Creating split data after basting

**F 9 9 9 L** Creating basting data

1. Press **F**.
2. Determine the feed point with  $\Delta \nabla \leftarrow \rightarrow$ .



## 3. Input command depending on the feed.

Press **L** if not specified.

## Creating split data

Command to be used

**2 2 0 L**

Stopping the needle at the upper end for the split.

**2 2 1 L**

Stopping the needle at the lower end for the split.

## 1. Input command depending on the split.



## Creating magnified data

Command to be used

**9 0 2 M**

Input for magnification (x2)

**9 0 5 M**

Input for magnification (x5)

**9 1 0 M**

Input for magnification (x10)

The following three scales are available for magnification: x2, x5, and x10.

Use a pattern sheet suitable for the magnified pattern.

The magnified data is reduced when the end code is input.

## 1. Make sure that the needle is at the home position.

Press **R** if not specified.2. Select magnification and press **9 0 0 M**.

## 3. Create a pattern data.

Move the needle with , then press  for setting.

## 4. Input the end code.



## Low-speed sewing

Carry out setting for low-speed sewing.

Command to be used

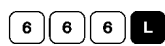
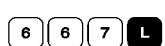
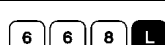
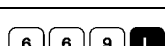
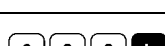
	The maximum sewing speed becomes 400 rpm or lower.
	The maximum sewing speed becomes 1200 rpm or lower.
	The maximum sewing speed becomes 800 rpm or lower.
	The maximum sewing speed becomes 600 rpm or lower.
	Canceling setting for low speed data

## 1. Move to the desired needle position for setting.

Refer to “Moving needle point” (page 123).

## 2. Select the type of low speed sewing and input the command.

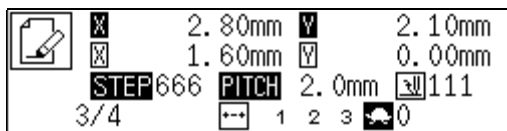

If multiple settings are required, input the stitch counts in 3 digits continuously and press .

## Setting the option output

This is set to flip/flop the option output.

Command to be used

7 7 1 L	Flipping/flopping option output 1
7 7 2 L	Flipping/flopping option output 2
7 7 3 L	Flipping/flopping option output 3
7 7 0 L	Canceling option output setting

1. Move the needle to the desired position.  
Refer to “Moving needle point” (page 123).
2. Input the command for option output.



## Ending programming

When programming is completed, input an end code.

Command to be used

1 1 1 E	Normal end
1 1 2 E	Fixing the sewing speed at 1000 rpm or lower.
1 1 3 E	Carrying out no thread wiping.
1 1 4 E	Setting the sewing speed at 1000 rpm or lower without thread wiping.
1 1 5 E	Carrying out no thread trimming.
1 1 6 E	Fixing the sewing speed at 1500 rpm or lower.

1. When the data is created, input the end code.



Data after the end code is input is deleted.

## Editing data

### Moving symmetrically to the Y axis

Command to be used

**0 0 1 M**

Moving symmetrically to the Y axis passing the start point of sewing

This function is available only when the needle is at the home position.

1. Make sure that the needle is at the home position.  
Press **R** if the needle is not at the home position.

2. Input **0 0 1 M**.



3. Press **L**.



### Moving symmetrically to the X axis

Command to be used

**0 1 0 M**

Moving symmetrically to the X axis passing the start point of sewing

This function is available only when the needle is at the home position.

1. Make sure that the needle is at the home position.  
Press **R** if the needle is not at the home position.

2. Input **0 1 0 M**.



3. Press **L**.



## Moving symmetrically to a point

Command to be used

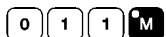

Moving symmetrically to the sewing start position

This function is available only when the needle is at the home position.

1. Make sure that the needle is at the home position.  
Press **R** if the needle is not at the home position.

2. Input **0 1 1 M**.



3. Press **L**.





## Rotating a pattern clockwise (counterclockwise)

Command to be used

**6 6 6 M** Rotating clockwise

**6 6 7 M** Rotating counterclockwise

This function is available only when the needle is at the home position.

Values of 1 - 359 degrees are available for input.

1. Make sure that the needle is at the home position.

Press **R** if the needle is not at the home position.

2. Determine the center point for rotation with **Δ▽◀▶**.



3. Input **6 6 6 M** or **6 6 7 M**.



4. Input the angle in 3 digits and press **L**.

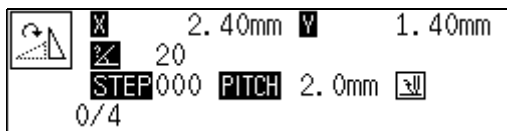

## Copying a pattern rotated clockwise (counterclockwise)

Command to be used

**6 7 6 M**

Copying a pattern rotated clockwise

**6 7 7 M**

Copying a pattern rotated counterclockwise

This function is available only when the needle is at the home position.

Values of 1 - 359 degrees are available for input.

The copied data is linked to the original data with a split data.

1. Make sure that the needle is at the home position.

Press **R** if the needle is not at the home position.

2. Determine the center point for rotation with **Δ▽◀▶**.



3. Input **6 7 6 M** or **6 7 7 M**.



4. Input the angle in 3 digits and press **L**.

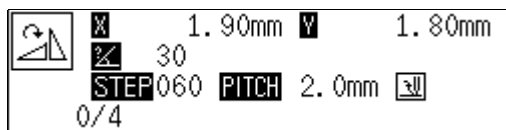

## Resizing

Command to be used

<b>8 8 8 M</b>	Resizing a pattern in the X and Y directions
<b>0 0 0 F</b>	Used to input magnification in the X direction.
<b>0 0 0 M</b>	Used to input magnification in the Y direction.

This function is available only when the needle is at the home position.

1. Make sure that the needle is at the home position.  
Press **R** if the needle is not at the home position.

2. Determine the reference point for resizing with **Δ▽◀▶**.



3. Input **8 8 8 M**.



4. Input the magnification in 3 digits in the X direction and press **F**.  
Magnification values of 0 - 400 are available for input.

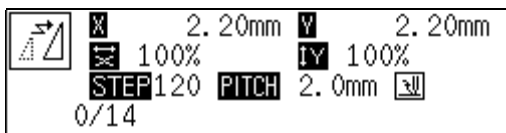

5. Input the magnification in 3 digits in the Y direction and press **M**.  
Magnification values of 0 - 400 are available for input.



6. Input the stitch length in 3 digits and press **L**.

If the value is "000", the stitch count remains unchanged. The stitch length increases or decreases.



## Copying a pattern resized

Command to be used

**999M**

Copying a pattern resized in the X and Y directions

**000F**

Used to input magnification in the X direction.

**000M**

Used to input magnification in the Y direction.

This function is available only when the needle is at the home position.

The copied data is linked to the original data with a split data.

1. Make sure that the needle is at the home position.  
Press **R** if the needle is not at the home position.

2. Determine the reference point for resizing with **Δ▽◀▶**.



3. Input **999M**.



4. Input the magnification in 3 digits in the X direction and press **F**.  
Magnification values of 0 - 400 are available for input.



5. Input the magnification in 3 digits in the Y direction and press **M**.  
Magnification values of 0 - 400 are available for input.

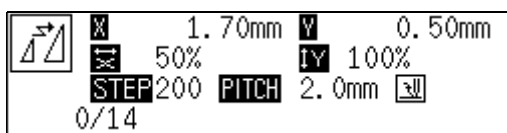

6. Input the stitch length in 3 digits and press **L**.  
If the value is "000", the stitch count remains unchanged. The stitch length increases or decreases.

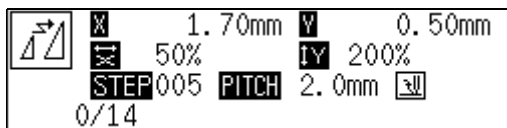

## Repeated copying

Command to be used

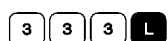

Copying data from the sewing start position or the feed point (excluding the number of feed boundaries to be ignored) to the current needle position for the area after the current needle position

1. Move the needle to the desired position.  
Refer to "Moving needle point" (page 123).
2. Input **3 3 3 L**.  
The needle follows the copied data. Press **-** to cancel halfway.



## Copying symmetrically to a point

Command to be used

**4 4 0 L**

Copying data symmetrically to the current needle position from the start point or the feed point (excluding the number of feed boundaries to be ignored) to the current needle position

1. Move the needle to the desired position.  
Refer to "Moving needle point" (page 123).

2. Input **4 4 0 L**.



## Copying to the X axis

Command to be used

**4 4 1 L**

Copying data to the X axis passing the current needle position from the start point or the feed point (excluding the number of feed boundaries to be ignored) to the current needle position

1. Move the needle to the desired position.  
Refer to "Moving needle point" (page 123).

2. Input **4 4 1 L**.

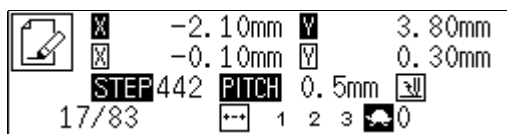

## Copying to the Y axis

Command to be used

**4 4 2 L**

Copying data to the Y axis passing the current the current needle position from the start point or the feed point (excluding the number of feed boundaries to be ignored) to the current needle position

1. Move the needle to the desired position.  
Refer to "Moving needle point" (page 123).

2. Input **4 4 2 L**.



## Copying in the reverse direction

Command to be used

**4 4 3 L**

Copying data in the reverse direction from the start point or the feed point (excluding the number of feed boundaries to be ignored) to the current needle position

1. Move the needle to the desired position.  
Refer to "Moving needle point" (page 123).

2. Input **4 4 3 L**.

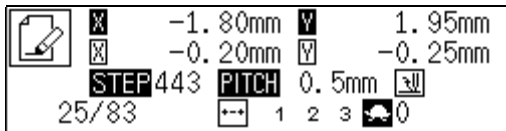

## Moving in parallel

Command to be used

**7 7 7 L**

Changing the movement data for the current needle position.

**L 7 7 7 L**

Moving data in parallel after the current needle position (using needle drop data to the moved position)

1. Move the needle to the desired position.  
Refer to “Moving needle point” (page 123).

2. Input **7 7 7 L** or **L 7 7 7 L**.



3. Determine the destination point with **Δ ▽ ◀ ▶** and press **L**.





## Displaying image

A data image is displayed during programming or editing.

1. Press .

Pattern image is displayed. Press  or  to return to the main menu.

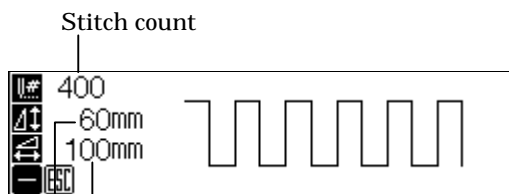

The data width is displayed in mm.

The data height is displayed in mm.

Press  to display the overall sewing area.

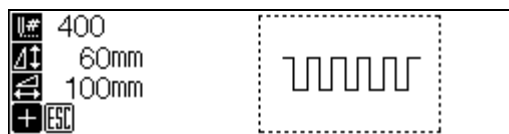

Press  to display the overall view of the data.

## Deleting data

Deletes the data during creating and displaying.

### Deleting a part of data

Command to be used



Deletes data after    stitches.

If this command is used at the sewing start position, the sewing start position is deleted and the current needle position becomes the sewing start position.



Deletes data before    stitches.

If this command is used at the sewing end position, the end code is deleted.

1. Move the needle to the desired position.  
Refer to "Moving needle point" (page 123).

2. Input the command.



Input to delete data after the current needle position.

Input to delete data before the current needle position.

Input the stitch count in .

### Deleting program data

1. Press    **R**.



An alarm sound is issued and input data is deleted.



Chapter 4  
Extended Option Output  
(BAS-300 Series)

\* The extended option output is not available to KE-436B, 436C.

### Function of extended option output

Required controls for pressing motion and automatic stacking of sewing can be implemented according to various functions of the machine.

When 3 conditions, i.e. output conditions, enabling conditions and disabling conditions are achieved, the extended option output functions. The relationship between the output and the conditions is as follows:

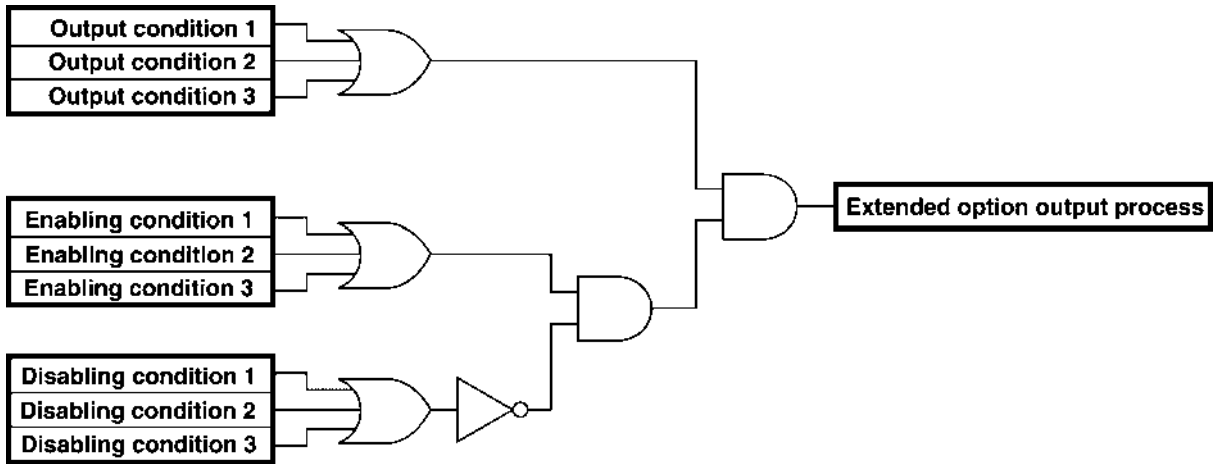

Three items each for output conditions, enabling conditions and disabling conditions can be set.

### Operating the extended option output

The following describes steps to display the menu for the extended option output.

1. Select  and press .



2. Select  and press .

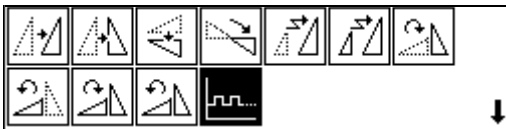

## Items which can be set in the extended option output

The following items can be set in the submenu of the extended option output.



Sets the details of the extended option output. (Refer to page 198.)



Sets the details of enabling conditions. (Refer to page 199.)



Reads the extended option output data of the floppy disk. (Refer to page 200.)



Writes the extended option output data of the floppy disk. (Refer to page 201.)



Deletes the extended option output data during editing or data of the floppy disk. (Refer to page 202.)

---



## Setting the extended option output

Items to be set are as follows:

Extended option output number	Specify a number out of 1 - 16. Refer to "Table of extended option output" (Refer to page 207.)
Operation setting	Select one out of ON, OFF, FLIP and FLOP with <b>+</b> <b>-</b> .
Output condition	Input conditions for the extended option output. 3 conditions can be specified. Refer to "Table of extended option output" (Refer to page 207.)
Timer 1	Set the time until the output varies after the output condition is established. Input the value in unit of 10 ms. Value of 0 or 10 - 2550 ms is set.
Timer 2	Set the time for implementation of the extended option output. Input the value in unit of 10 ms. Value of 0 or 10 - 2550 ms is set. When the value is 0, the output remains varying.

When setting is complete, be sure to press **↵**.

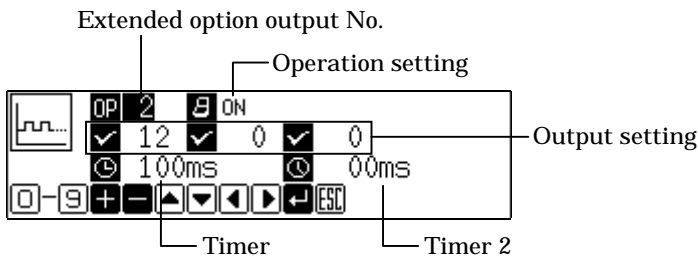

To cancel the set value, input **000** and press **P**.

To register the setting into the machine, carry out operation of "Writing the extended option output data" (page 201).



## Setting enabling conditions

If setting is not made, the status is always enable. To carry out setting as per the extended option output conditions, do not set enabling conditions.  
Items to be set are as follows:

Extended option output number	Specify a number out of 1 - 16. Refer to "Table of extended option output" (Refer to page 207.)
Enabling conditions	3 numbers of enabling conditions can be input. Refer to "Table of condition number" (Refer to page 203.)
Disabling conditions	3 numbers of disabling conditions can be input. Refer to "Table of condition number" (Refer to page 203.)

When setting is complete, be sure to press **↵**.

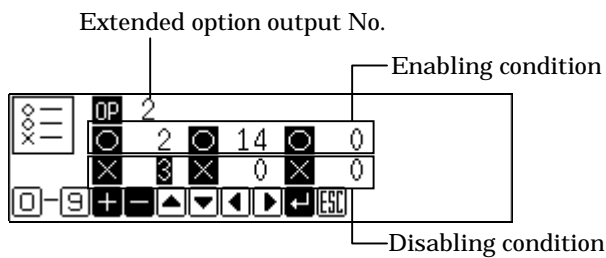

To cancel the set value, input **000** and press **P**.



## Reading the extended option output data

Reads the extended option output data from a floppy disk.

1. Select  and press .



2. Make sure that the floppy disk is set and press .  
Data is read and the submenu appears.



3. Select  and press .



4. Input the number of extended option output.  
Read data is displayed.

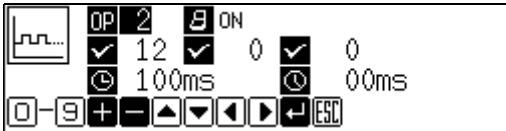

To register the data into the machine, carry out the operation in the next page.



## Writing the extended option output data

Writes the extended option output data memorized in the programmer into a floppy disk.

The data is also registered into the machine.

Be sure to use a formatted 2HD floppy disk.

"Formatting a floppy disk" (Refer to page 220.)

One floppy disk can record the data of extended option output No. 1 - 16.

1. Select  and press .



2. Make sure that the floppy disk is set and press .



Data is written and the submenu appears.



## Deleting the extended option output data

---

Deletes the extended option output data.

1. Select  and press .



2. Press .



The submenu appears.

## Table of condition number

Select and input the number for output conditions, enabling conditions and disabling conditions from the following:

### Machine operation mode

Condition No.	Operation meeting the condition
1	After a feed is complete at the home position
2	After a feed is complete at the sewing start position (at escape point, if applicable)
3	Before sewing or a test feed is started from the sewing start position (or the start position)
4	Before the machine upper shaft starts rotating at the first stitch
5	Before a test feed is started at the first stitch
6	After sewing or a test is complete (before moving to sewing start position or escape point)
7	After an emergency stop is reset
8	After a step back is started
9	Before halfway sewing is started
10	After the lower thread counter changes from 1 to 0 and the lower thread needs to be replaced
11	After the lower thread is replaced
12	After a program is started
13	After a program is complete
14	When a trigger data is detected during sewing
15	After an emergency stop occurs
16	After a thread breakage occurs
17	After a program is changed
18	After the power switch is turned on
19	After a low air pressure error is detected
20	Before movement to the next start position on completion of sewing in the split mode
21	After completion of sewing in the split mode and movement to the next start position

### Standard input

Condition No.	Operation meeting the condition
25	When the foot pedal is effective (before the work clamp moves up or down)
26	When the start pedal is effective (before starting operation)

## Standard output

Condition No.	Operation meeting the condition
30	After the work clamp is up (after the right work clamp is up for the air type)
31	After the work clamp is down
32	After the left work clamp is up (only for the air type)
33	After the left work clamp is down (only for the air type)
34	After the intermittent work clamp is up
35	After the intermittent work clamp is down
36	After the wiper output is off
37	After the thread trimmer output is off
38	Before the work clamp is up

## Extended option external input

Condition No.	Operation meeting the condition
40	When extended option input 1 is ON
41	When extended option input 1 is OFF
42	When extended option input 2 is ON
43	When extended option input 2 is OFF
44	When extended option input 3 is ON
45	When extended option input 3 is OFF
46	When extended option input 4 is ON
47	When extended option input 4 is OFF
48	When extended option input 5 is ON
49	When extended option input 5 is OFF
50	When extended option input 6 is ON
51	When extended option input 6 is OFF
52	When extended option input 7 is ON
53	When extended option input 7 is OFF
54	When extended option input 8 is ON
55	When extended option input 8 is OFF
56	When extended option input 9 is ON

57	When extended option input 9 is OFF
58	When extended option input 10 is ON
59	When extended option input 10 is OFF
60	When extended option input 11 is ON
61	When extended option input 11 is OFF
62	When extended option input 12 is ON
63	When extended option input 12 is OFF
64	When extended option input 13 is ON
65	When extended option input 13 is OFF

## Extended option output

Condition No.	Operation meeting the condition
70	When extended option output 1 is ON
71	When extended option output 1 is OFF
72	When extended option output 2 is ON
73	When extended option output 2 is OFF
77	When extended option output 3 is ON
75	When extended option output 3 is OFF
76	When extended option output 4 is ON
77	When extended option output 4 is OFF
78	When extended option output 5 is ON
79	When extended option output 5 is OFF
80	When extended option output 6 is ON
81	When extended option output 6 is OFF
82	When extended option output 7 is ON
83	When extended option output 7 is OFF
84	When extended option output 8 is ON
85	When extended option output 8 is OFF
86	When extended option output 9 is ON
87	When extended option output 9 is OFF
88	When extended option output 10 is ON

89	When extended option output 10 is OFF
90	When extended option output 11 is ON
91	When extended option output 11 is OFF
92	When extended option output 12 is ON
93	When extended option output 12 is OFF
94	When extended option output 13 is ON
95	When extended option output 13 is OFF
96	When extended option output 14 is ON
97	When extended option output 14 is OFF
98	When extended option output 15 is ON
99	When extended option output 15 is OFF
100	When extended option output 16 is ON
101	When extended option output 16 is OFF

Table of extended option input

Extended option input No.	Common input (condition) *1		Connector *2			
	Part name	Condition	Connector No.	Signal	+24V	0V
1	Eject right sensor	Memory SW-03 ON	P8(EXINA)	2	3	1
2	Eject left sensor	Memory SW-03 ON		5	6	4
3				8	9	7
4				11	12	10
5				14	15	13
6			P9(EXINB)	2	3	1
7				5	6	4
8				8	9	7
9				11	12	10
10				14	15	13
11	RESETSW	Memory SW-17 ON	P1	10	9	11
12	FIBER	DIPSWB-8ON	P3	5	4	6
13	AIR SW	Memory SW-1d ON	P4	12	11	9

\*1 Input available for optional parts. It is not used as extended option input if conditions are met.

\*2 Connector number and pin number on the main circuit board in the control box

Table of extended option output

Extended option output No.	Common output (condition) *1		Connector *2		
	Part name	Condition	Connector No.	Pin No.	
1	2 stage tension	Memory SW-0b ON	P4(AIR)	5	
2	Air wiper	Memory SW-09 ON		6	
	Pattern engraving drill	Memory SW-10 ON		6	
3	Auto eject	Memory SW-03 ON		7	
	Upper/lower engraving	Memory SW-10 ON		7	
4	Right work clamp turnover	Memory SW-19 ON		P21(EXOUT)	1
5	Left work clamp turnover	Memory SW-19 ON	2		
6			3		
7			4		
8			5		
9	Signal tower green	Memory SW-15 ON	6		
10	Signal tower yellow	Memory SW-15 ON	7		
11	Signal tower red	Memory SW-15 ON	8		
12	NEEDLE	DIPSWB-4 ON	P4(AIR)		8
13	FLIP	DIPSWA-6 ON			4
14	FOOT	DIPSWC-6 ON			3
15	LCLAMP	When 2 stage pressure bar is used		2	
16	RCLAMP	For the air type		1	

\*1 Input available for optional parts. It is not used as extended option input if conditions are met.

\*2 Connector number and pin number on the main circuit board in the control box

- The common terminal of connector P4 (AIR) is pin No. 11 at +24V.
- The common terminal of connector P21 (EXOUT) is pin No. 9 or 10 at +24V.



## Example of extended option output

To program the extended option output, prepare the timing chart. Then set the output condition, enable/disable conditions based on the chart.

The example shows how program setting values are determined from the timing chart. No explanation is given for the operation of the machine.

### Example 1 of extended option output

Sequence 1 for stacker

This is a sequence example for removing and stacking the material as soon as the work clamp is lifted after sewing.

Option output 4	BAR1 for holding material
Option output 5	BAR2 for moving material
Option output 6	AIR for air blow

Timing chart

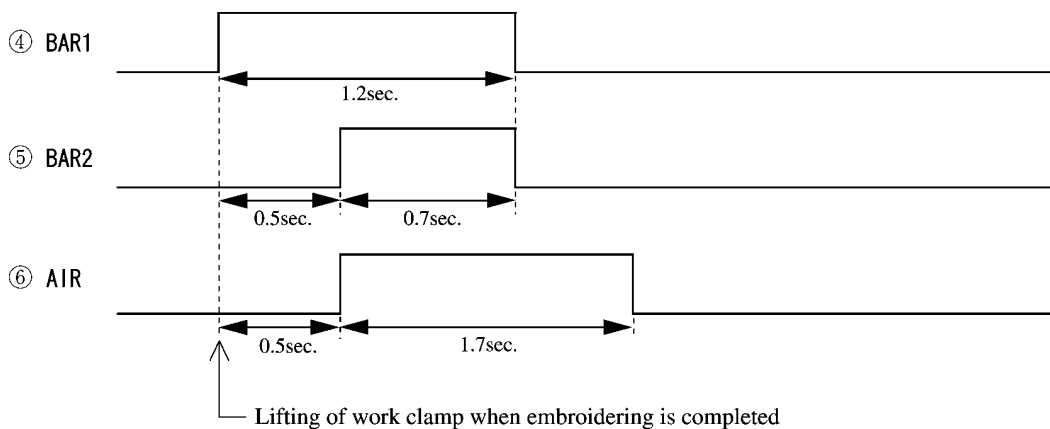

Program setting value

Output No.	Operation setting	Output condition		Timer 1 [mS]	Timer 2 [mS]	Enable condition O		Disable condition X	
		Condition No.	Description			Condition No.	Description	Condition No.	Description
4	ON	30	Lifting of work clamp	0	1200	6	Embroidering completion	81	Output 6 OFF
5	ON	76	Output 4 ON	500	700	—	—	—	—
6	ON	76	Output 4 ON	500	1700	—	—	—	—

## Example 2 of extended option output

## Sequence 2 for stacker

This is a sequence example for removing and stacking the material as soon as the work clamp is lifted after sewing.

Option output 3	UP/DW Up/Down for removing material
Option output 4	MOVE Movement for removing material
Option output 5	BAR1 for holding material
Option output 6	BAR2 for moving material

## Timing chart

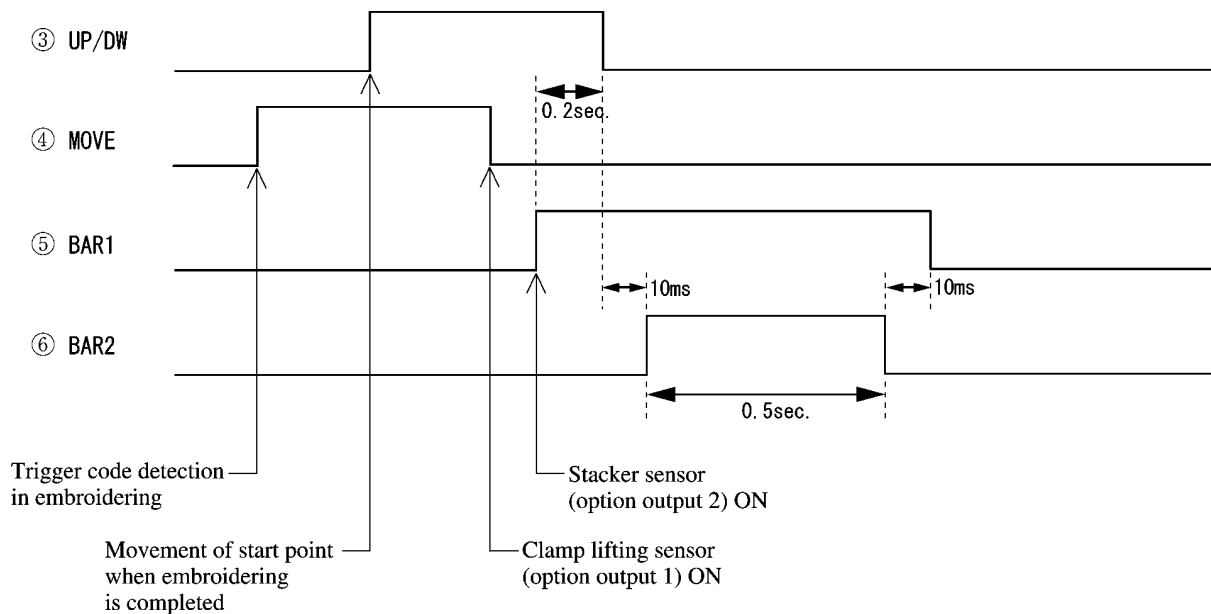

## Program setting value

Output No.	Operation setting	Output condition		Timer 1 [mS]	Timer 2 [mS]	Enable condition O		Disable condition X	
		Condition No.	Description			Condition No.	Description	Condition No.	Description
3	ON	2	Movement of start point	0	0	6	Completion of embroidering	1	Machine returns to home position
	OFF	78	Output 5 ON	200	0				
4	ON	14	Trigger detection	0	0	—	—	—	—
	OFF	40	Input 1 ON	0	0				
5	ON	42	Input 2 ON	0	0	—	—	—	—
	OFF	78	Output 6 OFF	10	0				
6	ON	75	Output 3 OFF	10	500	—	—	—	—

### Example 3 of extended option output

#### Signal for peripheral equipment

When the machine is connected to an external programmable controller, this is a sequence example for issuing timing signals.

Option output 4	READY Signal ready for sewing
Option output 5	END Signal of sewing completion
Option output 6	THBK Signal of detecting thread breakage

#### Timing chart

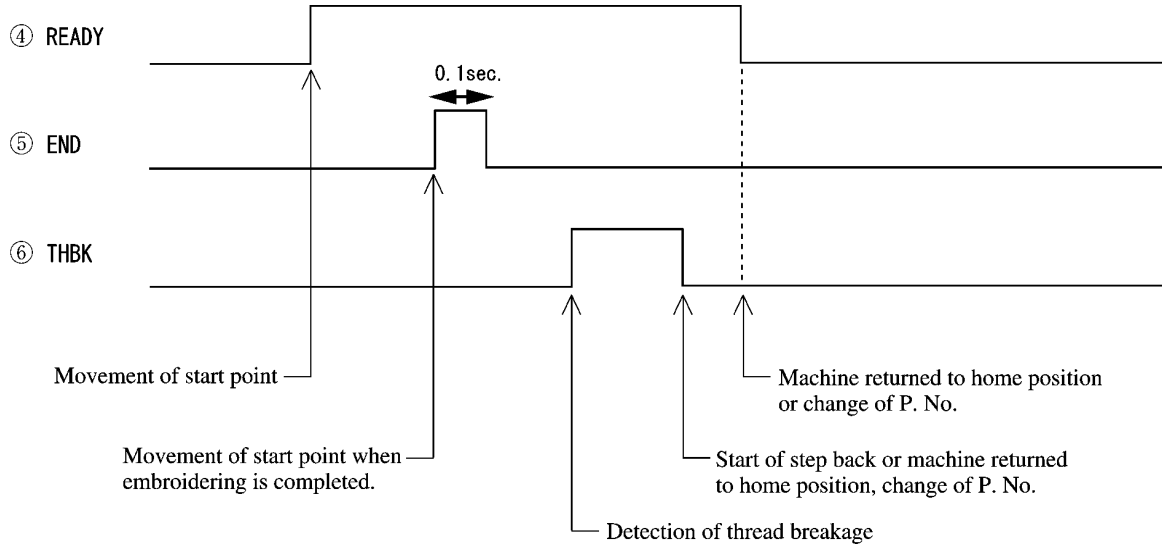

#### Program setting value

Output No.	Operation setting	Output condition		Timer 1 [mS]	Timer 2 [mS]	Enable condition O		Disable condition X	
		Condition No.	Description			Condition No.	Description	Condition No.	Description
4	ON	2	Movement of start point	0	0				
	OFF	1	Movement of start point	0	0	—	—	—	—
		17	Change of P. No.						
5	ON	2	Movement of start point	0	100	6	Embroidering completion	1	Machine returns to home position.
6	ON	16	Detection of thread breakage	0	0	—	—	—	—
	OFF	8	Start of step back						
		77	Output 4 OFF						

# Chapter 5

## Reading / Writing Data

## Reading data

Reads data from a floppy disk.



When there is no data for creation, data can be read by pressing by pressing the R/W button on the operation panel.

This operation cannot be available in command mode.

Data created in BAS-300, BAS-300A and BAS-300E series can also be read.

1. Select  and press .





2. Make sure that  is selected, and press .



3. Input the number of program with a numeric key.

If there is data,  appears.

If there is no data,  appears. If  appears, the data is from BAS-300 or BAS-300A series.



## Checking the image display (go to 7 when not checking)

4. Press **▽** and select .



OFF is highlighted if selected.

5. Press **+** to turn on.  
Press **-** to turn off again.



6. Press **↵**  
An image is displayed. Press **ESC** or **C** to return to the submenu.

Displays the stitch count.

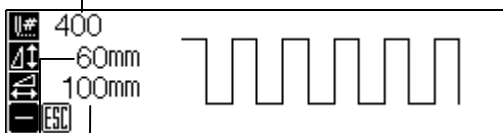

Press **-** to display the overall sewing data.

Displays the lateral length.

Displays the longitudinal length.



Press **+** to display the overall view of the data.

7. Press **↵** to read the data.  
To cancel reading, press **ESC**.

## Reading additional data

This is used to read other data continuously after reading a data.

Additionally read data is added to the editing data as a split data.

This operation cannot be available in command mode.

Data created in BAS-300, BAS-300A and BAS-300E series can also be read.

1. Select  and press .





2. Select  and press .





3. Input the number of program with a numeric key.

If there is data,  appears.

If there is no data,  appears. If  appears, the data is from BAS-300 or BAS-300A series.



Checking the image display (go to 7 when not checking)

4. Press  and select .



OFF is highlighted if selected.

5. Press  to turn on.

Press  to turn off again.



6. Press **↵**.

An image is displayed. Press **ESC** or **C** to return to the submenu.

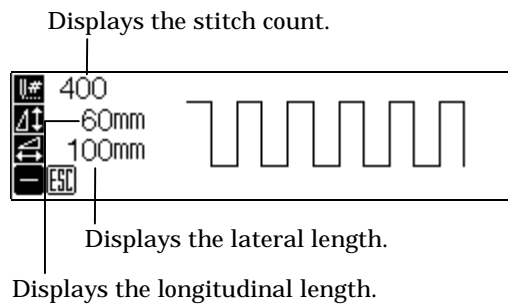

Press **-** to display the overall sewing data.



Press **+** to display the overall view of the data.

7. Press **↵** to read the data.

To cancel reading, press **ESC**.



## Writing data to a floppy disk

Writes data from the programmer to a floppy disk.



If there is data for creation, data can be written by pressing by pressing the Read/Write button on the operation panel.

Be sure to use a formatted 2HD floppy disk. The floppy disk accompanying this product is already formatted.

This operation cannot be available in command mode.

1. Select  and press .





2. Select  and press .



3. Input the number of program with a numeric key.

If there is data,  appears.

If there is no data,  appears. If  appears, the data is from BAS-300 or BAS-300A series.



## Checking the image display (go to 7 when not checking)

4. Press **▽** and select .



OFF is highlighted if selected.

5. Press **+** to turn on.  
Press **-** to turn off again.



6. Press **↵**.

An image is displayed. This is the image from data saved in a floppy disk, not the image currently in editing. Press **ESC** or **C** to return to the submenu.

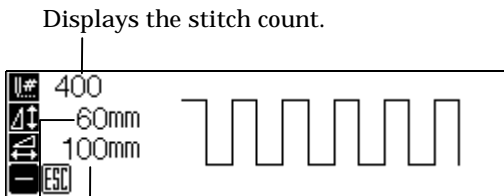

Displays the stitch count.

Displays the lateral length.

Displays the longitudinal length.

Press **-** to display the overall sewing data.

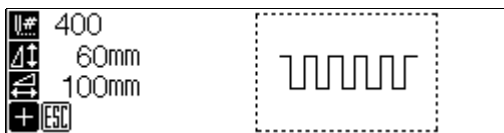

Press **+** to display the overall view of the data.

7. Press **↵** to read the data.  
To cancel reading, press **ESC**.

## Deleting data in a floppy disk

Deletes data saved in a floppy disk.



This operation cannot be available in command mode.

1. Select  and press .





2. Select  and press .



3. Input the number of program to be deleted with a numeric key.  
 If there is data,  appears.  
 If there is no data,  appears. If  appears, the data is from BAS-300 or BAS-300A series.





Checking the image display (go to 7 when not checking)

4. Press  and select .





OFF is highlighted if selected.

5. Press  to turn on.  
 Press  to turn off again.



6. Press .

An image is displayed. This is the image from data saved in a floppy disk, not the image currently in editing. Press  or  to return to the submenu.

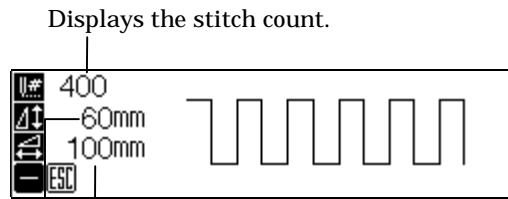

Displays the stitch count.

Displays the lateral length.

Displays the longitudinal length.

Press  to display the overall sewing area.



Press  to display the overall view of the data.

7. Press .

To cancel reading, press .

## Formatting a floppy disk

Formats a floppy disk for the programmer.



This operation cannot be available in command mode.

1. Select  and press .



2. Select  and press .



3. Press  for formatting and press  for not formatting.

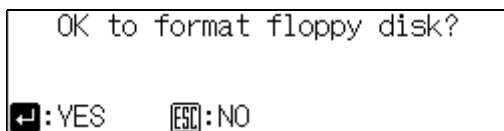



## Reading other types of data

Reads data created in other machines.

The following 3 data can be read.

DST

DSB

DSZ

This operation cannot be available in command mode.

1. Select  and press .



2. Make sure that  is selected, and press .



3. Select the data type for reading by pressing  and press  to put a check mark.



4. Press .

The data name (in 8 alphanumeric characters) saved in a floppy disk is displayed.



Checking the image display (go to 7 when not checking)

5. Press **▲▼◀▶** to select **☑**.

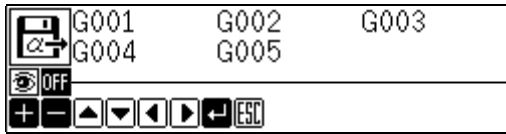

OFF is highlighted if selected.

6. Press **+** to turn on.  
Press **-** to turn off again.



7. Press **▲▼◀▶** to select the data to display.



8. Press **↵**.  
If the image is displayed, press **↵** again to read data. To cancel reading, press **ESC** or **C**.



Screen example when an image is displayed

# Chapter 6

## Preference





## Setting preference

Sets the operational preference of the programmer.

Items to be set are as follows:

Smoothing equal division	When a smoothing function is used, data is created for equal division within the specified pitch.
Area check	When data is created or edited, data outside the sewing area is not created.
Language	Display language such as error message is switched.

1. Select  and press .



2. Select the item with .

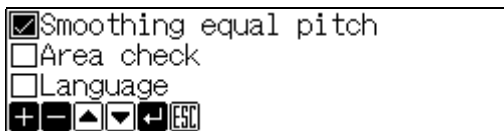

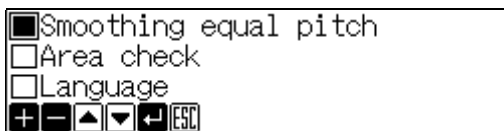

Selecting smoothing equal division or area check

3. For setting, press  to put a check mark.  
To cancel setting, press  to cancel the check mark.





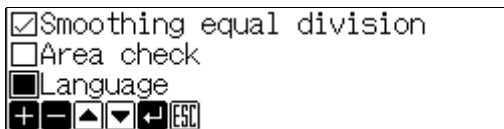

Switching language

4. Press  or .
- The language switches when pressed.



5. After setting is complete, press .

<input checked="" type="checkbox"/>	スムージング均等分割
<input type="checkbox"/>	エリアチェック
<input checked="" type="checkbox"/>	表示言語
<input type="checkbox"/>	
<input type="checkbox"/>	
<input type="checkbox"/>	
<input type="checkbox"/>	
<input type="checkbox"/>	 ESC



**brother**<sup>®</sup>

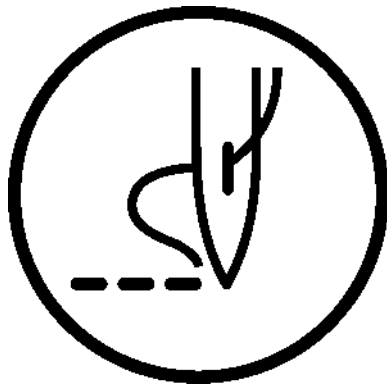

# INSTRUCTION MANUAL

**BROTHER INDUSTRIES,LTD. NAGOYA,JAPAN**

---

Printed in Japan

151-B11  
S93B11-212  
2002.12 WH (1)