

W
D
I
D
G
S
E
W
S
D

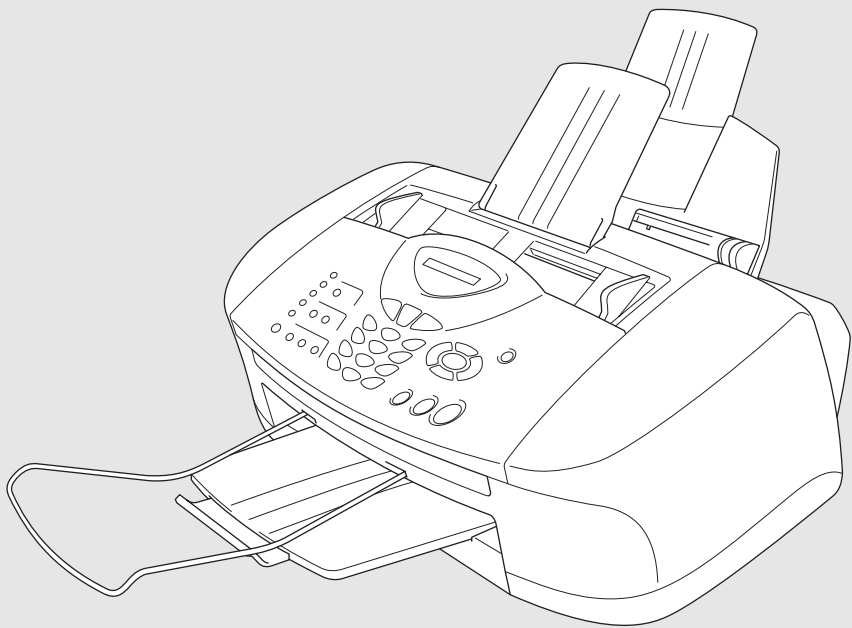

FAX-1820C MFC-3220C

brother®

If you need to call Customer Service

Please complete the following information for future reference:

Model Number: FAX-1820C and MFC-3220C
(Circle your model number)

Serial Number:* _____

Date of Purchase: _____

Place of Purchase: _____

* The serial number is on the back of the unit. Retain this User's Guide with your sales receipt as a permanent record of your purchase, in the event of theft, fire or warranty service.

Register your product on-line at

www.registermybrother.com

By registering your product with Brother International Corporation, you will be recorded as the original owner of the product. Your registration with Brother:

- may serve as confirmation of the purchase date of your product should you lose your receipt;
- may support an insurance claim by you in the event of product loss covered by insurance; and,
- will help us notify you of enhancements to your product and special offers.

The most convenient and efficient way to register your new product is on-line at www.registermybrother.com

Brother numbers

IMPORTANT

For technical help, you must call the country where you bought the machine. Calls must be made **from within** that country.

Register your product

By registering your product with Brother International Corporation, you will be recorded as the document owner of the product. Your registration with Brother:

- may serve as confirmation of the purchase date of your product should you lose your receipt;
- may support an insurance claim by you in the event of product loss covered by insurance; and,
- will help us notify you of enhancements to your product and special offers.

Please complete and fax the Brother Warranty Registration And Test Sheet or, for your convenience and most efficient way to register your new product, register on-line at

www.registermybrother.com

Frequently asked questions (FAQs)

The Brother Solutions Center is our one-stop resource for all your Fax Machine/Multi-Function Center needs. You can download the latest software and utilities, read FAQs and troubleshooting tips, and go to the “Solutions” section to learn how to get the most from your Brother product.

<http://solutions.brother.com>



You can check here for Brother driver updates.

For Customer Service

- In USA:** 1-800-284-4329 (voice)
1-901-379-1215 (fax)
1-800-284-3238 (TTY service for the hearing-impaired)
- In Canada:** 1-877-BROTHER (voice)
(514) 685-4898 (fax)
(514) 685-6464 (voice) **In Montreal**

Service Center Locator (USA only)

For the location of a Brother authorized service center, call 1-800-284-4357.

Service Center Locations (Canada only)

For the location of a Brother authorized service center, call 1-877-BROTHER.

Brother fax back system (USA only)

Brother has installed an easy-to-use fax back system, so you can get instant answers to common technical questions and product information for all Brother products. This system is available 24 hours a day, 7 days a week. You can use the system to receive faxed instructions and an Index of fax back subjects.

In USA only: 1-800-521-2846

The Brother fax back system number has been pre-programmed on One-Touch Key **01**.

Ordering accessories and supplies

For best quality results use only genuine Brother accessories, which are available at most Brother retailers. If you cannot find the accessory you need and you have a Visa, MasterCard, Discover, or American Express credit card, you can order accessories directly from Brother. (In the USA, you can visit us online for a complete selection of the Brother accessories and supplies that are available for purchase.)

In USA: 1-888-879-3232 (voice)
1-800-947-1445 (fax)

<http://www.brothermall.com>

In Canada: 1-877-BROTHER (voice)

Description	Item
Ink Cartridge<black>	LC31BK (Prints up to 500 pages)
Ink Cartridge<cyan>(blue)	LC31C (Prints up to 400 pages)
Ink Cartridge<magenta>(red)	LC31M (Prints up to 400 pages)
Ink Cartridge<yellow>	LC31Y (Prints up to 400 pages)
Telephone Line Cord	LG3077001
Telephone Handset	LE0446011 (Only for FAX-1820C)
Handset Curled Cord	LE6681001 (Only for FAX-1820C)
ADF Document Support	LE6396002 (FAX-1820C) LE6396003 (MFC-3220C)
ADF Document Output Support	LE3305001
Output Paper Support	LE9840002 (FAX-1820C) LE9840001 (MFC-3220C)
Power Protector for A/C Power Telephone Line Surges and Voltage Spikes (2 outlets)	QPD120
Power Protector for A/C Power Telephone Line Surges and Voltage Spikes (8 outlets)	FX120
User's Guide	LE9859001 (English for USA and Canada) LF4002001 (French For Canada)

Notice - Disclaimer of Warranties (USA and Canada)

BROTHER'S LICENSOR(S), AND THEIR DIRECTORS, OFFICERS, EMPLOYEES OR AGENTS (COLLECTIVELY BROTHER'S LICENSOR) MAKE NO WARRANTIES, EXPRESS OR IMPLIED, INCLUDING WITHOUT LIMITATION THE IMPLIED WARRANTIES OF MERCHANTABILITY AND FITNESS FOR A PARTICULAR PURPOSE, REGARDING THE SOFTWARE. BROTHER'S LICENSOR(S) DOES NOT WARRANT, GUARANTEE OR MAKE ANY REPRESENTATIONS REGARDING THE USE OR THE RESULTS OF THE USE OF THE SOFTWARE IN TERMS OF ITS CORRECTNESS, ACCURACY, RELIABILITY, CURRENTNESS OR OTHERWISE. THE ENTIRE RISK AS TO THE RESULTS AND PERFORMANCE OF THE SOFTWARE IS ASSUMED BY YOU. THE EXCLUSION OF IMPLIED WARRANTIES IS NOT PERMITTED BY SOME STATES IN THE USA AND SOME PROVINCES IN CANADA. THE ABOVE EXCLUSION MAY NOT APPLY TO YOU.

IN NO EVENT WILL BROTHER'S LICENSOR(S) BE LIABLE TO YOU FOR ANY CONSEQUENTIAL, INCIDENTAL OR INDIRECT DAMAGES (INCLUDING DAMAGES FOR LOSS OF BUSINESS PROFITS, BUSINESS INTERRUPTION, LOSS OF BUSINESS INFORMATION, AND THE LIKE) ARISING OUT OF THE USE OR INABILITY TO USE THE SOFTWARE EVEN IF BROTHER'S LICENSOR HAS BEEN ADVISED OF THE POSSIBILITY OF SUCH DAMAGES. BECAUSE SOME STATES IN THE USA AND SOME PROVINCES IN CANADA DO NOT ALLOW THE EXCLUSION OR LIMITATION OF LIABILITY FOR CONSEQUENTIAL OR INCIDENTAL DAMAGES, THE ABOVE LIMITATIONS MAY NOT APPLY TO YOU. IN ANY EVENT BROTHER'S LICENSOR'S LIABILITY TO YOU FOR ACTUAL DAMAGES FROM ANY CAUSE WHATSOEVER, AND REGARDLESS OF THE FORM OF THE ACTION (WHETHER IN CONTRACT, TORT (INCLUDING NEGLIGENCE), PRODUCT LIABILITY OR OTHERWISE), WILL BE LIMITED TO \$50.

Compilation and Publication Notice

Under the supervision of Brother Industries Ltd., this manual has been compiled and published, covering the latest product descriptions and specifications.

The contents of this manual and the specifications of this product are subject to change without notice.

Brother reserves the right to make changes without notice in the specifications and materials contained herein and shall not be responsible for any damages (including consequential) caused by reliance on the materials presented, including but not limited to typographical and other errors relating to the publication.

Brother® One Year Limited Warranty and Replacement Service (USA only)

Who is covered:

- This limited warranty (“warranty”) is given only to the document end-use/retail purchaser (referred to in this warranty as “Original Purchaser”) of the accompanying product, consumables and accessories (collectively referred to in this warranty as “this Product”).
- If you purchased a product from someone other than an authorized Brother reseller in the United States or if the product was used (including but not limited to floor models or refurbished product), prior to your purchase you are not the Original Purchaser and the product that you purchased is not covered by this warranty.

What is covered:

- This Product includes a Machine and Consumable and Accessory Items. Consumable and Accessory Items include but are not limited to print heads, toner, drums, ink cartridges, print cartridges, refill ribbons, therma PLUS paper and thermal paper.
- Except as otherwise provided herein, Brother warrants that the Machine and the accompanying Consumable and Accessory Items will be free from defects in materials and workmanship, when used under normal conditions.
- This warranty applies only to products purchased and used in the United States. For products purchased in, but used outside, the United States, this warranty covers only warranty service within the United States (and does not include shipping outside the United States).

What is the length of the Warranty Periods:

- Machines: one year from the original purchase date.
- Accompanying Consumable and Accessory Items: 90 days from the original purchase date or the rated life of consumable, whichever comes first.

What is NOT covered:

This warranty does not cover:

- (1) Physical damage to this Product;
- (2) Damage caused by improper installation, improper or abnormal use, misuse, neglect or accident (including but not limited to transporting this Product without the proper preparation and/or packaging);
- (3) Damage caused by another device or software used with this Product (including

but not limited to damage resulting from use of non Brother®-brand parts and Consumable and Accessory Items);

- (4) Consumable and Accessory Items that expired in accordance with a rated life; and,
- (5) Problems arising from other than defects in materials or workmanship.

This limited warranty is VOID if this Product has been altered or modified in any way (including but not limited to attempted warranty repair without authorization from Brother and/or alteration/removal of the serial number).

What to do if you think your Product is eligible for warranty service:

Report your issue to either our Customer Service Hotline at 1-800-284-4329 or a Brother Authorized Service Center **within the applicable warranty period.** Supply Brother or the Brother Authorized Service Center with a copy of your dated bill of sale showing that this Product was purchased within the U.S. For the name of local Brother Authorized Service Center(s), call 1-800-521-2846.

What Brother will ask you to do:

After contacting Brother or a Brother Authorized Service Center, you may be required to deliver (by hand if you prefer) or send the Product properly packaged, freight prepaid, to the Authorized Service Center together with a photocopy of your bill of sale. **You are responsible for the cost of shipping, packing product, and insurance (if you desire). You are also responsible for loss or damage to this Product in shipping.**

What Brother will do:

If the problem reported concerning your Machine and/or accompanying Consumable and Accessory Items is covered by this warranty and if you first reported the problem to Brother or an Authorized Service Center within the applicable warranty period, Brother or its Authorized Service Center will repair or replace the Machine and/or accompanying Consumable and Accessory Items at no charge to you for parts or labor. The decision as to whether to repair or replace the Machine and/or accompanying Consumable and Accessory Items is made by Brother in its sole discretion. Brother reserves the right to supply a refurbished or remanufactured replacement Machine and/or accompanying Consumable and Accessory Items and use refurbished parts

Brother® One Year Limited Warranty and Replacement Service (USA only)

provided such replacement products conform to the manufacturer's specifications for new product/parts. The repaired or replacement Machine and/or accompanying Consumable and Accessory Items will be returned to you freight prepaid or made available for you to pick up at a conveniently located Authorized Service Center.

If the Machine and/or accompanying Consumable and Accessory Items are not covered by this warranty (either stage), you will be charged for shipping the Machine and/or accompanying Consumable and Accessory Items back to you.

The foregoing are your sole (i.e., only) and exclusive remedies under this warranty.

What happens when Brother elects to replace your Machine:

When a replacement Machine is authorized by Brother, and you have delivered the Machine to an Authorized Service Center, the Authorized Service Center will provide you with a replacement Machine after receiving one from Brother. If you are dealing directly with Brother, Brother will send to you a replacement Machine with the understanding that you will, after receipt of the replacement Machine, supply the required proof of purchase information, together with the Machine that Brother agreed to replace. You are then expected to pack the Machine that Brother agreed to replace in the package from the replacement Machine and return it to Brother using the pre-paid freight bill supplied by Brother in accordance with the instructions provided by Brother. Since you will be in possession of two machines, Brother will require that you provide a valid major credit card number. Brother will issue a hold against the credit card account number that you provide until Brother receives your original Product and determines that your original Product is entitled to warranty coverage. Your credit card will be charged up to the cost of a new Product only if: (i) you do not return your original Product to Brother within five (5) business days; (ii) the problems with your original Product are not covered by the limited warranty; (iii) the proper packaging instructions are not followed and has caused damage to the product; or (iv) the warranty period on your original Product has expired or has not been sufficiently validated with a copy of the proof of purchase (bill of sale). The replacement Machine you receive (even if refurbished or remanufactured) will be

covered by the balance of the limited warranty period remaining on the original Product, plus an additional thirty (30) days. You will keep the replacement Machine that is sent to you and your original Machine shall become the property of Brother. **Retain your original Accessory Items and a copy of the return freight bill, signed by the courier.**

Limitations:

Brother is not responsible for damage to or loss of any equipment, media, programs or data related to the use of this Product. Except for that repair or replacement as described above, Brother shall not be liable for any direct, indirect, incidental or consequential damages or specific relief. Because some states do not allow the exclusion or limitation of consequential or incidental damages, the above limitation may not apply to you.

THIS WARRANTY IS GIVEN IN LIEU OF ALL OTHER WARRANTIES, WRITTEN OR ORAL, WHETHER EXPRESSED BY AFFIRMATION, PROMISE, DESCRIPTION, DRAWING, MODEL OR SAMPLE. ANY AND ALL WARRANTIES OTHER THAN THIS ONE, WHETHER EXPRESS OR IMPLIED, INCLUDING IMPLIED WARRANTIES OF MERCHANTABILITY AND FITNESS FOR A PARTICULAR PURPOSE, ARE HEREBY DISCLAIMED.

- This Limited Warranty is the only warranty that Brother is giving for this Product. It is the *final expression and the exclusive and only statement* of Brother's obligations to you. It replaces all other agreements and understandings that you may have with Brother or its representatives.
- This warranty gives you certain rights and you may also have other rights that may vary from state to state.
- This Limited Warranty (and Brother's obligation to you) may not be changed in any way unless you and Brother sign the same piece of paper in which we (1) refer to this Product and your bill of sale date, (2) describe the change to this warranty and (3) agree to make that change.

Important: We recommend that you keep all original packing materials, in the event that you ship this product.

BROTHER MULTIFUNCTION CENTER/FACSIMILE MACHINE LIMITED WARRANTY (Canada only)

Pursuant to this limited warranty of 1 year from the date of purchase for labour and parts, Brother International Corporation (Canada) Ltd. ("Brother"), or its Authorized Service Centers, will repair this MFC/Facsimile machine free of charge if defective in material or workmanship. This Limited Warranty does not include cleaning, consumables (including, without limitation, print cartridges, print head, toner and drum) or damage caused by accident, neglect, misuse or improper installation or operation, any damage caused from service, maintenance, modifications, or tampering by anyone other than a Brother Authorized Service Representative, or from the use of supplies or consumable items that are non-Brother products. Operation of the MFC/Facsimile machine in excess of the specifications or with the Serial Number or Rating Label removed shall be deemed abuse and all repairs thereafter shall be the sole liability of the end-user/purchaser. In order to obtain warranty service, the MFC/Facsimile machine must be delivered or shipped freight prepaid by the end user/purchaser to a "Brother" Authorized Service Center, together with your Proof of Purchase in the form of a Sales Receipt.

For laser products: Failure to remove the Toner Cartridge (and Toner Drum Unit on applicable models) during shipping will cause severe damage to the MFC/Facsimile and will VOID the Warranty. (Refer to your User's Guide for proper packaging.)

For ink-jet products: Do not remove the ink cartridges during shipping. Damage to your print head resulting from packing without the ink cartridges will VOID your warranty. (Refer to your User's Guide for proper packaging.)

BROTHER DISCLAIMS ALL OTHER WARRANTIES EXPRESSED OR IMPLIED INCLUDING, WITHOUT LIMITATION, ANY IMPLIED WARRANTIES OF MERCHANTABILITY OR FITNESS FOR A PARTICULAR PURPOSE, EXCEPT TO THE EXTENT THAT ANY WARRANTIES IMPLIED BY LAW CANNOT BE VALIDLY WAIVED.

No oral or written information, advice or representation provided by Brother, its Authorized Service Centers, Distributors, Dealers, Agents or employees, shall create another warranty or modify this warranty. This warranty states Brother's entire liability and your exclusive remedy against Brother for any failure of the MFC/Facsimile machine to operate properly.

Neither Brother nor anyone else involved in the development, production, or delivery of this MFC/Facsimile machine shall be liable for any indirect, incidental, special, consequential, exemplary, or punitive damages, including lost profits, arising from the use of or inability to use the product, even if advised by the end user/purchaser of the possibility of such damages. Since some Provinces do not allow the above limitation of liability, such limitation may not apply to you.

This Limited Warranty gives you specific legal rights and you may also have other rights which vary from Providence to Providence.

Warranty Service is available at Brother Authorized Service Centers throughout Canada. For Technical Support or for the name and location of your nearest Authorized Service Center call 1-877-BROTHER. Within Montreal, please call (514) 685-6464.

Internet support: support@brother.ca or browse

Brother's Web Site: www.brother.com

Brother International Corporation (Canada) Ltd.

1 Rue Hôtel de Ville

Dollard-Des-Ormeaux, QC H9B 3H6





At your side.
brother®

Safety precautions

To use the machine safely

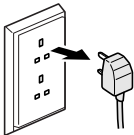
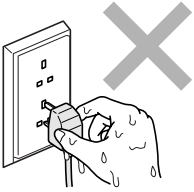
Please refer to these instructions for later reference and before attempting any maintenance.

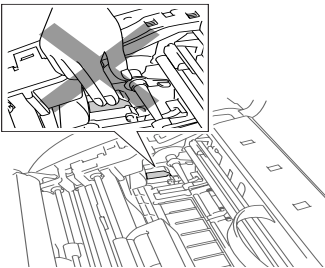
WARNING

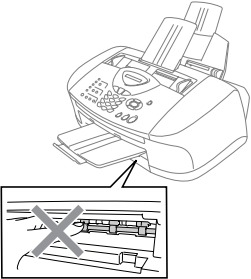
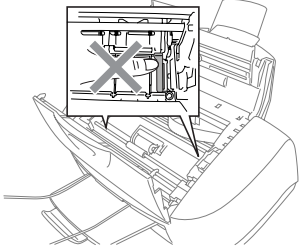
	<p>There are high voltage electrodes inside the machine. Before you clean the machine or clear a paper jam, make sure you have unplugged the power cord from the AC power outlet.</p> 	<p>Do not handle the plug with wet hands. Doing this might cause an electrical shock.</p> 
	<p>After you use your machine, the area shown in the illustrations is extremely HOT! To prevent injuries, be careful not to put your fingers.</p>	
	<p>To prevent injuries, be careful not to touch the area shaded in the illustration.</p> 	<p>To prevent injuries, be careful not to touch the edge of the metallic part shown in the illustration.</p> 

- Use caution when installing or modifying telephone lines. Never touch telephone wires or terminals that are not insulated unless the telephone line has been disconnected at the wall jack. Never install telephone wiring during a lightning storm. Never install a telephone wall jack in a wet location.
- This product must be installed near a AC power outlet that is easily accessible. In case of emergencies, you must disconnect the power cord from the AC power outlet in order to shut off power completely.
- To reduce the risk of shock or fire, use only a No. 26 AWG or larger telecommunication line cord.

 **Caution**

- Lightning and power surges can damage this product! We recommend that you use a quality surge protection device on the AC power line and on the telephone line, or unplug the cords during a lightning storm.

IMPORTANT SAFETY INSTRUCTIONS

When using your telephone equipment, basic safety precautions should always be followed to reduce the risk of fire, electric shock and injury to persons, including the following:

1. Do not use this product near water, for example, near a bath tub, wash bowl, kitchen sink or laundry tub, in a wet basement or near a swimming pool.
2. Avoid using a telephone (other than a cordless type) during an electrical storm. There may be a remote risk of electric shock from lightning.
3. Do not use the telephone to report a gas leak in the vicinity of the leak.
4. Use only the power cord and batteries indicated in this guide. Do not dispose of batteries in a fire. They may explode. Check with local codes for possible special disposal instructions.

SAVE THESE INSTRUCTIONS

Choosing a location

Place your machine on a flat, stable surface that is free of vibration and shocks, such as a desk. Put the machine near a telephone wall jack and a standard, grounded AC power outlet. Choose a location where the temperature remains between 50°F and 95°F (10°-35°C).

! Caution

- Avoid placing your machine in a high-traffic area.
- Avoid placing your machine on the carpet.
- Do not place near heaters, air conditioners, water, chemicals, or refrigerators.
- Do not expose the machine to direct sunlight, excessive heat, moisture, or dust.
- Do not connect your machine to electrical outlets controlled by wall switches or automatic timers.
- Disruption of power can wipe out information in the machine's memory.
- Do not connect your machine to electrical outlets on the same circuit as large appliances or other equipment that might disrupt the power supply.
- Avoid interference sources, such as speakers or the base units of cordless phones.



Quick Reference Guide



Sending faxes

Automatic Transmission

- 1 If it is not illuminated in green, press  (**Fax**).
- 2 Load your original. (See *Load originals* on page 2-1.)
- 3 Enter the fax number using One-Touch, Speed-Dial, Search or the dial pad.
- 4 Press **Black Start** or **Color Start**.

Receiving faxes

Select Receive Mode

- 1 Press **Menu/Set, 0, 1**.
- 2 Press  or  to select Fax Only, Manual, Fax/Tel or External TAD, and then press **Menu/Set**.

Storing numbers

Storing One-Touch Dial numbers

- 1 Press **Menu/Set, 2, 3, 1**.
- 2 Press the One-Touch key where you want to store the number.
- 3 Enter a number (up to 20 digits), and then press **Menu/Set**.
- 4 Enter a name up to 15 characters (or leave it blank), and then press **Menu/Set**.
- 5 Press **Stop/Exit**.

Storing Speed-Dial numbers



- 1 Press **Menu/Set, 2, 3, 2**.
- 2 Using the dial pad, enter a two-digit Speed-Dial location number, and then press **Menu/Set**.
- 3 Enter a number (up to 20 digits), and then press **Menu/Set**.
- 4 Enter a name up to 15 characters (or leave it blank), and then press **Menu/Set**.
- 5 Press **Stop/Exit**.

Dialing operations

One-Touch Dialing/ Speed-Dialing

- 1 If it is not illuminated in green, press  (**Fax**).
- 2 Load your original. (See *Load originals* on page 2-1.)
- 3 Press the One-Touch key of the number you want to call.
—OR—
Press **Search/Speed Dial**, press #, and then press the two-digit Speed-Dial number.
- 4 Press **Black Start** or **Color Start**.

Using Search

- 1 If it is not illuminated in green, press  (**Fax**).
- 2 Press **Search/Speed Dial**, and then enter the first letter of the name you're looking for.
- 3 Press  or  search the memory.
- 4 Press **Black Start** or **Color Start**.





Making copies

Single copy

- 1 Press  (**Copy**) to illuminate it in green.

- 2 Load your original. (See *Load originals* on page 2-1.)
- 3 Press **Black Start** or **Color Start**.

Sorting multiple copies (Using the ADF)

- 1 Press  (**Copy**) to illuminate it in green.
- 2 Load your original in the ADF.
- 3 Use the dial pad to enter the number of copies you want (up to 99).
- 4 Press **Options**.
- 5 Press  or  select **Stack/Sort**, and then press **Menu/Set**.
- 6 Press  or  select **Sort**, and then press **Menu/Set**.
- 7 Press **Black Start** or **Color Start**.

Brother fax back system:

In USA: 1-800-521-2846

Brother Global Web Site:

<http://www.brother.com>

Frequently Asked Questions (FAQs)
and Product Support

<http://solutions.brother.com>

Brother Accessories & Supplies:

In USA: 1-888-879-3232 (voice)

1-800-947-1445 (fax)

<http://www.brothermall.com>

In Canada: 1-877-BROTHER (voice)

Table of Contents

1

Introduction	1-1
Using this Guide	1-1
Finding information	1-1
Symbols used in this Guide	1-1
Fax Test Sheet and Product Registration (USA only)	1-2
On-Line Registration (USA and Canada)	1-2
Control panel overview	1-3
Turning the machine on and off	1-6
About fax machines	1-7
Custom features	1-7
Do you have Voice Mail on the phone line?	1-7
Why should there be problems?	1-7
How can you avoid possible problems?	1-7
Fax tones and handshake	1-8
ECM (Error Correction Mode)	1-9
Connecting the machine	1-9
Connecting an external telephone	1-9
Connecting an external telephone answering device (TAD)	1-10
Sequence	1-10
Connections	1-11
Recording outgoing message (OGM) on an external TAD	1-12
Special line considerations	1-13
Roll over phone lines	1-13
Two-line phone system	1-13
Converting telephone wall outlets	1-14
Installing machine, external two-line tad and two-line telephone	1-15
Multi-line connections (PBX)	1-16
If you are installing the machine to work with a PBX	1-16
Custom features on your phone line	1-16

2

Loading originals and paper	2-1
Load originals	2-1
Using the automatic document feeder (ADF)	2-1
Recommended environment	2-1

About paper.....	2-3
Handling and using special paper.....	2-3
Recommended paper	2-3
Paper capacity of the paper tray	2-4
Paper specifications for the paper tray	2-4
Paper capacity of the output paper support	2-5
Printable area.....	2-6
How to load paper and envelopes	2-7
To load paper or other media.....	2-7
To load glossy paper.....	2-8
To load envelopes.....	2-8

3

On-screen programming	3-1
User-friendly programming.....	3-1
Menu table	3-1
Memory storage	3-1
Navigation keys.....	3-2

4

Getting started	4-1
Initial Setup	4-1
Setting the Date and Time	4-1
Setting the Station ID	4-2
Entering text.....	4-3
Inserting spaces.....	4-3
Making corrections.....	4-3
Repeating letters.....	4-3
Special characters and symbols	4-4
Setting Tone and Pulse dialing mode	4-4
General Setup.....	4-5
Setting the Mode Timer (MFC-3220C only)	4-5
Setting the Mode Timer (FAX-1820C only).....	4-5
Setting the Paper Type	4-6
Setting the Paper Size	4-6
Setting the Ring Volume	4-7
Setting the Beeper Volume	4-7
Setting the Speaker Volume	4-8
Setting the Handset Volume (FAX-1820C only)	4-8
Choosing the Handset Volume	
(For Volume Amplify) (FAX-1820C only)	4-9
Setting Volume Amplify (FAX-1820C only)	4-10
Turning on Automatic Daylight Savings Time	4-10
On/Off Setting	4-11

Setup Receive	5-1
Basic receiving operations.....	5-1
Choosing the Receive Mode	5-1
To select or change your Receive Mode	5-2
Setting the Ring Delay	5-2
Setting the F/T Ring Time (Fax/Tel mode only).....	5-3
Easy Receive (MFC-3220C only)	5-4
Easy Receive (FAX-1820C only).....	5-5
Printing a reduced incoming fax (Auto Reduction)	5-6
Receiving a fax at the end of a conversation (FAX-1820C only).....	5-6
Printing a fax from the memory	5-6
Advanced receiving operations	5-7
Operation from extension telephones.....	5-7
For Fax/Tel mode only.....	5-7
Using a cordless external handset	5-8
Changing the remote codes	5-8
Polling.....	5-9
Setting up Polling Receive	5-9
Setting up Sequential Polling Receive	5-9
Telephone services	5-10
Distinctive Ring.....	5-10
What does your telephone company's 'Distinctive Ring' do?	5-10
What does Brother's 'Distinctive Ring' do?	5-10
Do you have Voice Mail?.....	5-11
Before you choose the ring pattern to register	5-11
Registering the Distinctive Ring pattern	5-12
Turning off the Distinctive Ring	5-13
Caller ID.....	5-14
Viewing Caller ID List	5-14
Printing Caller ID List.....	5-15
Call Waiting Caller ID (FAX-1820C only).....	5-15

Setup Send	6-1
How to fax.....	6-1
Enter Fax mode	6-1
How to dial.....	6-1
Manual dialing	6-1
One-Touch dialing	6-2
Speed-Dialing	6-2
Search	6-3
Out of Memory message	6-3

Automatic transmission (MFC-3220C only)	6-4
This is the easiest way to send a fax.....	6-4
Automatic transmission (FAX-1820C only).....	6-4
This is the easiest way to send a fax.....	6-4
Manual transmission (MFC-3220C only)	6-5
Manual transmission (FAX-1820C only)	6-5
Sending a fax at the end of a conversation (FAX-1820C only).....	6-6
Basic sending operations.....	6-7
Sending faxes using multiple settings.....	6-7
Contrast	6-7
Fax Resolution.....	6-8
Manual and automatic fax Redial	6-9
Color fax transmission	6-9
Dual Access (Not available for color faxes)	6-10
Real Time Transmission.....	6-10
Checking job status	6-11
Canceling a job while scanning, dialing and sending the original	6-12
Canceling a scheduled job.....	6-12
Advanced sending operations	6-13
Broadcasting (Not available for color faxes).....	6-13
Overseas Mode	6-14
Delayed Fax (Not available for color faxes).....	6-15
Setting up Polled Transmit (Not available for color faxes).....	6-16
Delayed Batch Transmission (Not available for color faxes).....	6-17

7

Quick-Dial numbers and dialing options	7-1
Storing numbers for easy dialing	7-1
Storing One-Touch Dial numbers	7-1
Storing Speed-Dial numbers.....	7-3
Changing One-Touch and Speed-Dial numbers.....	7-4
Setting up Groups for Broadcasting.....	7-5
Dialing options	7-7
Access codes and credit card numbers.....	7-7
Pause	7-8
Fax Redial.....	7-8
Tone or Pulse	7-8
Telephone (voice) operation (FAX-1820C only)	7-9
How to dial	7-9
Making a telephone call.....	7-9
Hold	7-9

8

Remote Fax Options	8-1
Fax Forwarding/Paging	8-1
Programming a Fax Forwarding number.....	8-1
Programming your pager number.....	8-2
Setting Fax Storage	8-3
Backup Print	8-3
This is a safety feature in case the power goes off so you won't lose your messages.....	8-3
Setting your Remote Access Code.....	8-4
Remote Retrieval	8-5
Using your Remote Access Code.....	8-5
Remote commands	8-6
Retrieving fax messages	8-7
Changing your Fax Forwarding number	8-7

9

Printing reports	9-1
Machine settings and activity.....	9-1
Customizing the Transmission Verification Report.....	9-1
Setting the Journal Period	9-2
Printing reports (FAX-1820C only)	9-3
To print a report.....	9-3
Printing reports (MFC-3220C only).....	9-4
To print a report.....	9-4

10

Making copies	10-1
Using the machine as a copier	10-1
Enter Copy mode.....	10-1
Making a single copy	10-2
Making multiple copies	10-2
Out of Memory message	10-2
Using the Copy keys (Temporary settings)	10-3
Quality	10-4
Options	10-5
Enlarge/Reduce.....	10-6
Paper Type	10-7
Paper Size	10-8
Brightness	10-8
Contrast.....	10-9
Sorting copies.....	10-9
N in 1 copy (Page Layout).....	10-10
Changing the default copy settings	10-12
Copy Quality	10-12
Brightness.....	10-12
Contrast.....	10-12

Color Adjustment	10-13
Legal limitations	10-14

11

Important information	11-1
Standard telephone and FCC Notices	
These notices are in effect on models sold and used in the United States only.....	11-1
Federal Communications Commission (FCC)	
Declaration of Conformity (USA only).....	11-3
Important	11-4
Industry Canada Compliance Statement	
(Canada only)	11-4
LAN connection	11-4
International ENERGY STAR® Compliance Statement....	11-4
Important safety instructions.....	11-5
Trademarks.....	11-7

12

Troubleshooting and routine maintenance	12-1
Troubleshooting	12-1
Error messages	12-1
Original jam.....	12-4
Original is jammed inside the front of the control panel.....	12-4
Original is jammed inside the back of the control panel.....	12-4
Printer jam or paper jam	12-5
Paper is jammed inside the front of the machine....	12-5
Paper is jammed in the paper tray.....	12-5
Paper is jammed inside the paper tray	12-6
Paper is jammed inside the machine.....	12-7
If you are having difficulty with your machine	12-8
How to improve print quality	12-11
Cleaning the print head.....	12-11
Print Quality Check.....	12-11
Checking the ink volume.....	12-14
Packing and shipping the machine	12-15
Routine maintenance.....	12-18
Cleaning the scanner.....	12-18
Cleaning the machine printer platen.....	12-19
Replacing the ink cartridges	12-20

G

Glossary	G-1
-----------------------	------------

Specifications	S-1
Product description	S-1
General	S-1
Print media	S-3
Copy	S-3
Fax.....	S-4
Scanner (MFC-3220C only).....	S-5
Printer	S-6
Interfaces.....	S-7
Computer requirements	S-7
Consumable items	S-8
Index	I-1
Remote Retrieval Access card	R-1

1 Introduction

Using this Guide

Thank you for buying a Brother fax machine or Multi-Function Center (MFC). Your machine is simple to use, with LCD screen instructions to guide you through programming it. You can make the most of your machine by viewing through this Guide.





Finding information

All the chapter headings and subheadings are listed in the Table of Contents. You will be able to find information about a specific feature or operation by checking the Index at the back of this Guide.

Symbols used in this Guide

Throughout this Guide you'll see special symbols alerting you to important warnings, notes and actions. To make things clearer and to help you press the correct keys, we used special fonts and added some of the messages that will appear in the LCD.

- | | |
|--------------------|---|
| Bold | Bold typeface identifies specific keys on the machine control panel. |
| <i>Italics</i> | Italicized typeface emphasizes an important point or refers you to a related topic. |
| <i>Courier New</i> | Courier New type face identifies the messages on the LCD of the machine. |

-  Warnings inform you what to do to avoid possible personal injury.
-  Cautions specify procedures you must follow or avoid to prevent possible damage to the machine.
-  Notes tell you how you should respond to a situation that may arise or give tips about how the current operation works with other features.
-  Improper Setup alerts you to devices and operations that are not compatible with the machine.

Fax Test Sheet and Product Registration (USA only)

After setting your Station ID, please fill in the Test Sheet included with your machine and fax it to Brother's Automated Fax Response System as your first transmission. This will check that your machine is working properly.

To get a response, you must have set up your Station ID.
(See *Setting the Station ID* on page 4-2.)

In USA Only: 1-877-268-9575

When your Test Sheet is received, a Confirmation Sheet and Product Registration form will be sent back to your machine. Please fill in the form and return it to complete your registration.

On-Line Registration (USA and Canada)

- 1** Insert the MFL-Pro Suite CD-ROM into your CD-ROM drive.
- 2** Click **Online Registration** to register your product.

Control panel overview

FAX-1820C

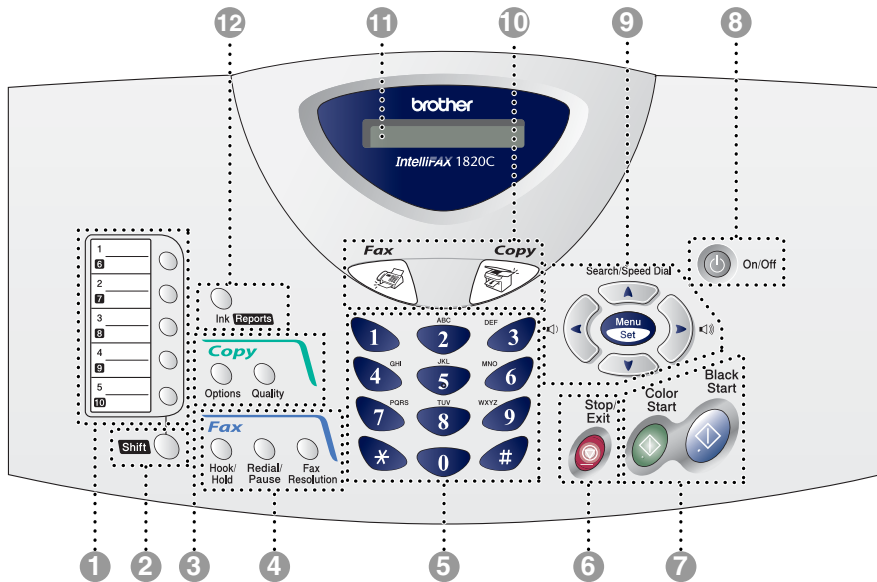

MFC-3220C

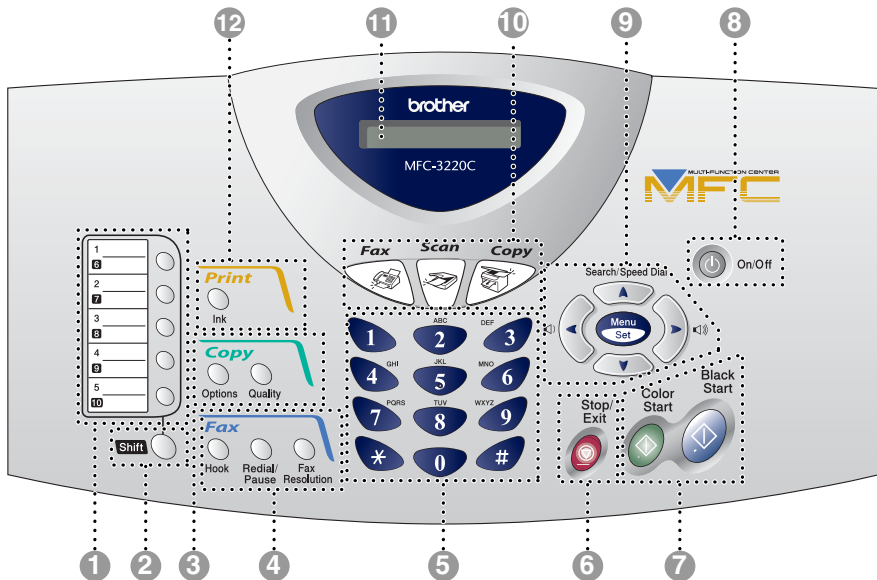

1 One-Touch keys

These 5 keys give you instant access to 10 previously stored dial numbers.

2 Shift (MFC-3220C only)

To access memory locations 6 through 10 in the One-Touch keys hold down the Shift key.

2 Shift (FAX-1820C only)

To access memory locations 6 through 10 in the One-Touch keys, or Report Menu in the **Ink/Report** key, hold down the **Shift** key.

3 Copy keys

(Temporary settings):

Options

You can quickly and easily select temporary settings for copying.

Quality

Use this key to temporarily change the quality for Copying.

4 Fax and telephone keys:

Redial/Pause

Redials the last number you called. It also inserts a pause in auto dial numbers.

Hook (MFC-3220C only)

Press before dialing if you want to make sure a fax machine answers, and then press **Black Start** or **Color Start**.

Hook/Hold (FAX-1820C only)

Lets you dial telephone and fax numbers without lifting the handset.

—OR—

Lets you place telephone calls on hold.

Fax Resolution

Sets the resolution when you send a fax.

5 Dial Pad

Use these keys to dial telephone and fax numbers and as a keyboard for entering information into the machine.

The # key lets you temporarily switch the dialing mode during a telephone call from Pulse to Tone.

6 Stop/Exit

Stops an operation or exits from the menu.

7 Black Start

Lets you start sending faxes or making copies in black and white.

Also for MFC models, lets you start a scanning operation. (Color or mono, depending on the scanning setting on your PC)

8 Color Start

Lets you start sending faxes or making copies in full color.

Also for MFC models, lets you start a scanning operation. (Color or mono, depending on the scanning setting on your PC)

8 On/Off

You can turn the machine on or off.

9 Navigation keys:

Menu/Set

Lets you access the Menu to program and store your settings in the machine.

Volume

When using the speaker or during ringing in fax mode, you can press these keys to adjust the volume.

For fax model, you can adjust the handset volume too.

Search/Speed Dial

Lets you look up numbers that are stored in the dialing memory. It also lets you dial stored numbers by pressing # and a two-digit number.



Press to scroll backward to a menu selection.

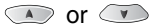

Press to scroll through the menus and options.

Also, you can use these keys to do a numerical search for the names of stored numbers in fax mode.

10 **Mode keys:**



Fax

Lets you access Fax mode.



Copy

Lets you access Copy mode.



Scan (MFC-3220C only)

Lets you access Scan mode.

11 **Liquid Crystal Display (LCD)**

Displays messages on the screen to help you to set up and use your machine.

12 **Ink/Reports (FAX-1820C only)**

Lets you clean the print heads, replace an ink cartridge and check the available ink volume.

—OR—

Lets you access the Reports menu by pressing it with the **Shift** key.

Ink (MFC-3220C only)

Lets you clean the print heads, replace an ink cartridge and check the available ink volume.

Turning the machine on and off

When the machine is idle, you can turn it on and off by pressing the **On/Off** key. In OFF mode, no machine operations will be available. Even if you turned the machine off, it will periodically clean the print head to preserve print quality.

Turning the machine off

Press and hold down the **On/Off** key until the LCD shows:

Shutting Down

The LCD light will go off.

Turning the machine on

Press and hold down the **On/Off** key until the LCD shows:

Please Wait

The LCD will show the date and time (Fax mode).



Even in OFF mode, you can receive fax and telephone calls by customizing the **On/Off** key as explained below. (See *On/Off Setting* on page 4-11.)

On/Off Setting	Receive Mode	Available Operations
Fax Receive:Off (default)	—	No machine operations will be available.
Fax Receive:On	Fax Only Fax/Tel (FAX-1820C only) External TAD	Fax Receive, Easy Receive, Delayed Fax, Remote Fax Options, Remote Retrieval. <ul style="list-style-type: none"> ■ You cannot receive a fax with Black Start or Color Start. ■ Delayed Fax and Remote Fax Options should be set before you switch off the machine.
	Manual Fax/Tel* (MFC-3220C only)	Delayed Fax, Easy Receive <ul style="list-style-type: none"> ■ You cannot receive a fax with Black Start or Color Start. ■ Delayed Fax and Remote Fax Options should be set before you switch off the machine. ■ *You cannot receive a fax automatically even if you have set the receive mode to Fax/Tel.

About fax machines

Custom features

Do you have Voice Mail on the phone line?

If you have Voice Mail on the phone line where you will install your new machine, *there is a strong possibility that Voice Mail and the machine may conflict with each other while receiving incoming calls.*

Why should there be problems?

Since both the machine and Voice Mail will pick up the call, after the number of rings you have set, each of them has the ability to keep the other from receiving calls.

For example, if your Voice Mail is set to answer after two rings and your machine is set to answer after four, your Voice Mail will stop your machine from receiving faxes.

If you set Voice Mail and the Brother machine to answer after the same number of rings, there is no way of knowing which one will answer first. It is important to remember that neither Voice Mail nor the machine can pass the call back to the other after the call has been answered.

How can you avoid possible problems?

A very good way to avoid problems like the one mentioned, *is to get a second phone number on your present phone line.*

Many people with Voice Mail choose an alternative service, which is called “Distinctive Ring”, and they are very satisfied with it. (See *Distinctive Ring* on page 5-10.)

Another way to avoid possible problems is to replace your Voice Mail with an answering machine. Your Brother machine is designed to work with an answering machine or TAD (telephone answering device).

(See *Connecting an external telephone answering device (TAD)* on page 1-10.)

Fax tones and handshake

When someone is sending a fax, the machine sends fax calling tones (CNG tones). These are quiet, intermittent beeps every 4-seconds. You'll hear them after you dial and press **Black Start** or **Color Start** and they will continue for about 60 seconds after dialing. During that time, the sending machine must begin the "handshake", or connection, with the receiving machine.

Each time you use automatic procedures to send a fax, you are sending CNG tones over the phone line. You'll soon learn to listen for these quiet beeps each time you answer a phone on your fax line, so you will know if you are receiving a fax message.

The receiving fax responds with fax receiving tones, which are loud, chirping sounds. A receiving fax chirps for about 40 seconds over the phone line, and the LCD shows *Receiving*.

If your machine is set to the *Fax Only* mode, it will answer every call automatically with fax receiving tones. If the other person hangs up, your machine will continue to send the "chirps" for about 40 seconds, and the LCD continues to show *Receiving*. To cancel receiving, press **Stop/Exit**.

The fax 'handshake' is the time in which the sending machine's CNG tones and the receiving machine's "chirps" overlap. This must be for at least 2 to 4 seconds, so both machines can understand how each is sending and receiving the fax. The handshake cannot begin until the call is answered, and the CNG tones only last for about 60 seconds after the number is dialed. So it is important for the receiving machine to answer the call in as few rings as possible.



When you have an external Telephone Answering Device (TAD) on your fax line, your TAD will decide the number of rings before the call is answered.

Pay special attention to the directions for connecting a TAD in this chapter. (See *Connecting an external telephone answering device (TAD)* on page 1-10.)

ECM (Error Correction Mode)

The Error Correction Mode (ECM) is a way for the machine to check a fax transmission while it is in progress. If the machine detects errors during fax transmission, it resends the pages of the fax that had an error. ECM transmissions are only possible between fax machines that both have this feature. If they do, you may send and receive fax messages that are continuously being checked by the machine.

Your machine must have enough memory for this feature to work.

Connecting the machine

Connecting an external telephone

If your machine does not have a handset, you can connect a separate telephone (or telephone answering device) directly to your machine as shown in the diagram below.

Connect the modular plug on the telephone line cord to the jack labeled EXT. in the back of the machine.

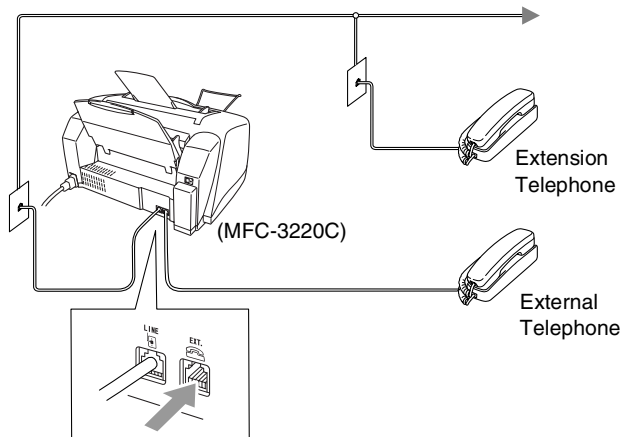

When this phone (or TAD) is in use, the LCD shows Telephone.

Connecting an external telephone answering device (TAD)

Sequence

You may choose to connect an answering device. However, when you have an **external** TAD on the same telephone line as the machine, the TAD answers all calls and the machine “listens” for fax calling (CNG) tones. If it hears them, the machine takes over the call and receives the fax. If it doesn’t hear CNG tones, the machine lets the TAD continue playing your outgoing message so your caller can leave you a voice message.

The TAD must answer within four rings (the recommended setting is two rings). The machine cannot hear CNG tones until the TAD has answered the call, and with four rings there are only 8 to 10 seconds of CNG tones left for the fax “handshake”. Make sure you carefully follow the instructions in this guide for recording your outgoing message. We do not recommend using the toll saver feature on your external answering machine if it exceeds five rings.



If you do not receive all your faxes, reduce the Ring Delay setting on your external TAD.



If You Subscribe to your Telephone Company’s Distinctive Ring Service:

You may connect an external TAD to a separate wall jack only if you subscribe to your telephone company’s Distinctive Ring service, have registered the distinctive ring pattern on your machine, and use that number as a fax number. The recommended setting is at least four rings on the external TAD when you have the telephone company’s Distinctive Ring Service. You cannot use the Toll Saver setting.



If You Do Not Subscribe to Distinctive Ring Service:

You must plug your TAD into the EXT. jack of your machine. If your TAD is plugged into a wall jack, both your machine and the TAD will try to control the phone line. (See illustration below.)

- ⊘ Unless you are using Distinctive Ring, do not connect a TAD elsewhere on the same phone line.

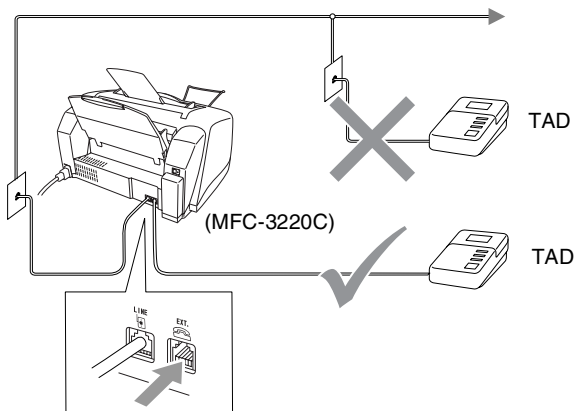

When the TAD is in use, the LCD shows `Telephone`.

Connections

The external TAD must be plugged into the back of the machine, into the jack labeled EXT. Your machine cannot work properly if you plug the TAD into a wall jack (unless you are using Distinctive Ring).

- 1 Plug the telephone line cord from the telephone wall jack into the back of the machine, in the jack labeled LINE.
- 2 Plug the telephone line cord from your external TAD into the back of the machine, in the jack labeled EXT. (Make sure this cord is connected to the TAD at the TAD's telephone *line* jack, and not its telephone jack.)
- 3 Set your external TAD to four rings or less. (The machine's Ring Delay setting does not apply.)
- 4 Record the outgoing message on your external TAD.
- 5 Set the TAD to answer calls.
- 6 Set the Receive Mode to `External TAD`.
(See *Choosing the Receive Mode* on page 5-1.)

Recording outgoing message (OGM) on an external TAD

Timing is important in recording this message. The message sets up the ways to handle both manual and automatic fax reception.

- 1** Record 5 seconds of silence at the beginning of your message. (This allows your machine time to listen for the fax CNG tones of automatic transmissions before they stop.)
- 2** Limit your speaking to 20 seconds.
- 3** End your 20-second message by giving your Fax Receive Code for people sending manual faxes. For example:
*“After the beep, leave a message or send a fax by pressing * 51 and Start.”*



We recommend beginning your OGM with an initial 5-second silence because the machine cannot hear fax tones over a resonant or loud voice. You may try omitting this pause, but if your machine has trouble receiving, then you must re-record the OGM to include it.

Special line considerations

Roll over phone lines

A roll over phone system is a group of two or more separate telephone lines that pass incoming calls to each other if they are busy. The calls are usually passed down or “rolled over” to the next available phone line in a preset order.

Your machine can work in a roll over system as long as it is the last number in the sequence, so the call cannot roll away. Do not put the machine on any of the other numbers; when the other lines are busy and a second fax call is received, the fax call would be transferred to a line that does not have a fax machine. **Your machine will work best on a dedicated line.**

Two-line phone system

A two-line phone system is nothing more than two separate phone numbers on the same wall outlet. The two phone numbers can be on separate jacks (RJ11) or combined into one jack (RJ14). Your machine must be plugged into an RJ11 jack. RJ11 and RJ14 jacks may be equal in size and appearance and both may contain four wires (black, red, green, yellow). To test the type of jack, plug in a two-line phone and see if it can access both lines. If it can, you must separate the line for your machine. (See *Easy Receive (MFC-3220C only)* on page 5-4.)

Converting telephone wall outlets

There are three ways to convert to an RJ11 jack. The first two ways may require assistance from the telephone company. You can change the wall outlets from one RJ14 jack to two RJ11 jacks. Or, you can have an RJ11 wall outlet installed and slave or jump one of the phone numbers to it.

The third way is the easiest: Buy a triplex adapter. You can plug a triplex adapter into an RJ14 outlet. It separates the wires into two separate RJ11 jacks (Line 1, Line 2) and a third RJ14 jack (Lines 1 and 2). If your machine is on Line 1, plug the machine into L1 of the triplex adapter. If your machine is on Line 2, plug it into L2 of the triple adapter.

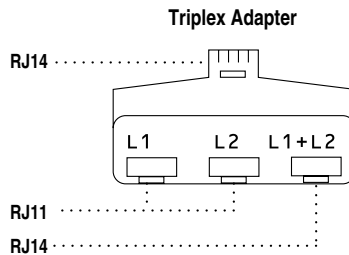

Installing machine, external two-line tad and two-line telephone

When you are installing an external two-line telephone answering device (TAD) and a two-line telephone, your machine must be isolated on one line at both the wall jack and at the TAD. The most common connection is to put the machine on Line 2, which is explained in the following steps. The back of the two-line TAD must have two telephone jacks: one labeled L1 or L1/L2, and the other labeled L2. You will need at least three telephone line cords, the one that came with your machine and two for your external two-line TAD. You will need a fourth line cord if you add a two-line telephone.

- 1** Place the two-line TAD and the two-line telephone next to your machine.
- 2** Plug one end of the telephone line cord for your machine into the L2 jack of the triplex adapter. Plug the other end into the LINE jack on the back of the machine.
- 3** Plug one end of the first telephone line cord for your TAD into the L1 jack of the triplex adapter. Plug the other end into the L1 or L1/L2 jack of the two-line TAD.
- 4** Plug one end of the second telephone line cord for your TAD into the L2 jack of the two-line TAD. Plug the other end into the EXT. jack on the left side of the machine.

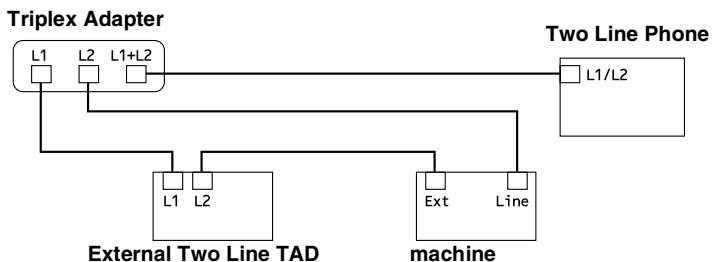

You can keep two-line telephones on other wall outlets as always. There are two ways to add a two-line telephone to the machine's wall outlet. You can plug the telephone line cord from the two-line telephone into the L1+L2 jack of the triplex adapter. Or, you can plug the two-line telephone into the TEL jack of the two-line TAD.

Multi-line connections (PBX)

Most offices use a central telephone system. While it is often relatively simple to connect the machine to a key system or a PBX (Private Branch Exchange), we suggest that you contact the company that installed your telephone system and ask them to connect the machine for you. It is advisable to have a separate line for the machine. You can then leave the Receive Mode set to Fax Only to receive faxes any time of the day or night.

If the machine is to be connected to a multi-line system, ask your installer to connect the unit to the last line on the system. This prevents the unit from being activated each time a telephone call is received.

If you are installing the machine to work with a PBX

- 1** It is not guaranteed that the unit will operate properly under all circumstances with a PBX. Any cases of difficulty should be reported first to the company that handles your PBX.
- 2** If all incoming calls will be answered by a switchboard operator, it is recommended that the Receive Mode be set to `Manual`. All incoming calls should initially be regarded as telephone calls.

Custom features on your phone line

If you have Call Waiting/Caller ID with the MFC-3220C, or Call Waiting, Voice Mail, RingMaster, an answering service, an alarm system or other custom feature on one phone line it may create a problem with the operation of your machine. (See *Custom features* on page 1-7 and See *Custom features on a single line*. on page 12-9.)

2

Loading originals and paper

Load originals

You can copy and scan from the ADF (automatic document feeder).

Using the automatic document feeder (ADF)

- Originals must be between 3.5 and 8.5 inches wide and 5 and 14 inches long.
- Make sure you place the originals **face down, top edge first**.
- Adjust the paper guides to fit the width of your original.

Recommended environment

Temperature: 68° F - 86° F

Humidity: 50% - 70%

Paper: 20 lb LTR

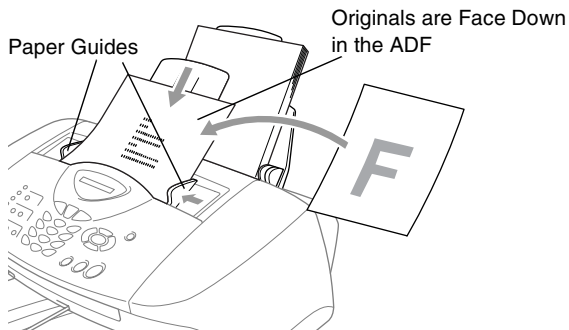

- The automatic document feeder (ADF) can hold up to 20 pages, feeding each one individually through the machine. Use standard (20 lb²) paper when using the ADF.

Fan the paper, and then stagger the pages in the ADF as shown:

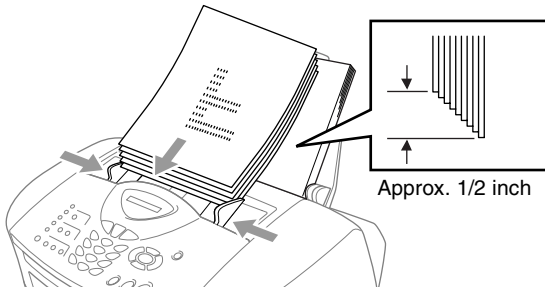

- ⊘ **DO NOT** use curled, wrinkled, folded, or ripped paper, or paper with staples, paper clips, paste or tape attached. **DO NOT** use cardboard, newspaper or fabric.

Make sure originals written with ink are completely dry.

- ⊘ **DO NOT** pull on the original while it is in progress.

About paper

The print quality of your original can be affected by the kind of paper you use in the machine.

To get the best print quality for the settings you've chosen, always set the Paper Type to match the type of paper you load.

You can use plain paper, inkjet paper (coated paper), glossy paper, transparencies and envelopes.

We recommend testing various paper types before purchasing large quantities.

For best results, use the recommended paper.



When you print on inkjet paper (coated paper), transparencies and glossy paper, be sure to select the proper media in the “Basic” tab in the printer driver.

Also avoid stacking by removing each page after it exits the machine to avoid smudging.

Handling and using special paper

- Store paper in its original packaging, and keep it sealed. Keep the paper flat and away from moisture, direct sunlight and heat.
- The coated side of glossy paper is shiny. Avoid touching the shiny (coated) side. Load glossy paper with the shiny side facing up toward you.
- Avoid touching either side of transparencies, because they absorb water and perspiration easily, and this may cause decreased output quality. Transparencies designed for laser printers/copiers may stain your next original. Use only transparencies recommended for inkjet printing.

Recommended paper



The output quality depends on the paper type and paper brand. Visit us at <http://solutions.brother.com> and check the latest recommendations for paper that can be used with your machine.

Paper capacity of the paper tray

Paper Type	Paper Size	Number of sheets
Plain Paper (Cut Sheet)	Letter, Executive, A5, A6, B5 (JIS)	100 of 20 lb up to 0.39 in.
	Legal	50 of 20 lb
Inkjet Paper	Letter	20
Glossy Paper	Letter	20
Transparencies	Letter	10
Envelopes	DL, COM-10, C5, Monarch, JE4	10
Photo Card	4" x 6", L (3.5" x 5"), 2L (5" x 7")	30
Index Card	5" x 8"	30

* You can copy only on Letter, Legal and Photo Card (4"(W) x 6"(H)) paper.

* You can receive faxes only on Letter or Legal paper.

Paper specifications for the paper tray

Cut Sheet Paper Weight	Plain Paper: 17 to 32 lb Inkjet Paper: 17 to 53 lb Glossy Paper: Up to 58 lb Index card: Up to 32 lb
Thickness	Plain Paper: 0.003 to 0.006 in. Inkjet Paper: 0.003 to 0.01 in. Glossy Paper: Up to 0.01 in. Envelopes: Up to 0.02 in. Photo Card: Up to 0.017 in. Index card: Up to 0.006 in.

Paper capacity of the output paper support

Output Paper Support	<p>Up to 50 sheets of 20 lb (Letter)</p> <ul style="list-style-type: none">■ Transparencies and glossy paper must be picked up from the output paper support one page at a time to avoid smudging.■ Legal cannot be stacked on the output paper support.
----------------------	---

⊘ Do not use paper or envelopes:

- that are damaged, curled, wrinkled, or irregularly shaped

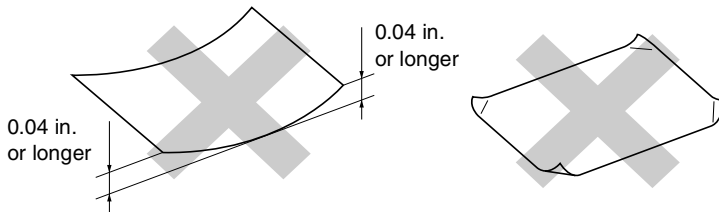

- that are extremely shiny or highly textured
- that were previously printed by a printer
- that cannot be arranged uniformly when stacked
- that are made with a short grain

⊘ Do not use envelopes:

- that are of a baggy construction
- that are embossed (have raised writing on them)
- that have clasps on them
- that are not sharply creased
- that are preprinted on the inside

Printable area

The printable area depends on the settings in the application you are using. The figures below show the unprintable areas on cut sheet paper and envelopes.

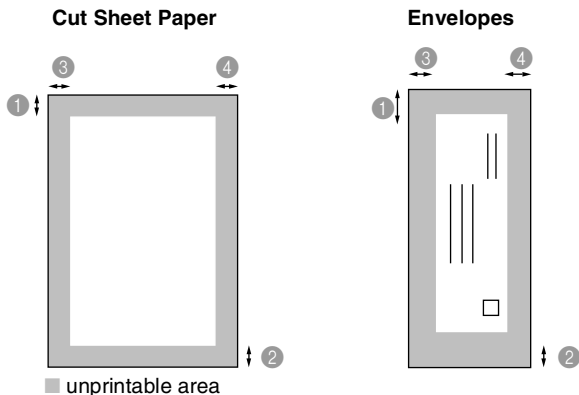

Paper	Paper Size		① Top	② Bottom	③ Left	④ Right
Cut Sheet	Letter, Legal	Fax	0.12 in.	0.47 in.	0.23 in.	0.23 in.
		Copy	0.12 in.	0.12 in.	0.12 in.	0.12 in.
		Printer	0.12 in.	0.12 in.	0.23 in.	0.23 in.
	A5, A6, JIS_B5 Executive	Printer	0.12 in.	0.12 in.	0.12 in.	0.12 in.
Photo Card	4" x 6"	Printer	0.12 in.	0.12 in.	0.12 in.	0.12 in.
		Copy	0.12 in.	0.12 in.	0.12 in.	0.12 in.
	L (3.5" x 5"), 2L (5" x 7")	Printer	0.12 in.	0.12 in.	0.12 in.	0.12 in.
Index Card	5" x 8"	Printer	0.12 in.	0.12 in.	0.12 in.	0.12 in.
Envelopes	DL, C5, COM10, Monarch, JE4	Printer	0.39 in.	0.79 in.	0.12 in.	0.12 in.



Printable area depends on the Printer driver settings.

The figures above are approximate and the printable area may vary depending on the type of cut sheet paper you are using.

How to load paper and envelopes

To load paper or other media

- 1 Fan the stack of paper well to avoid paper jams and mis-feeds.

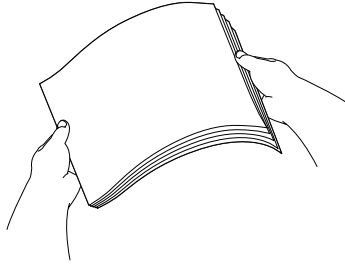

- 2 Unfold the paper support, and press and slide the paper guide to fit the paper width.

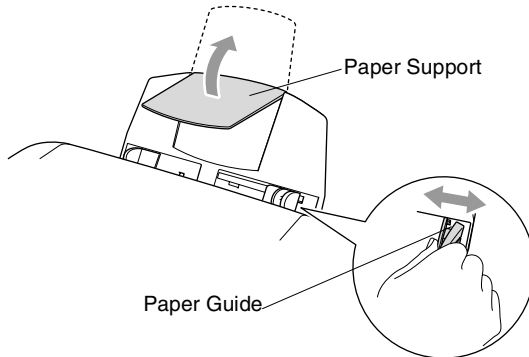

- 3 Gently insert the paper. Make sure the print side is towards you and the paper is below the maximum paper mark.

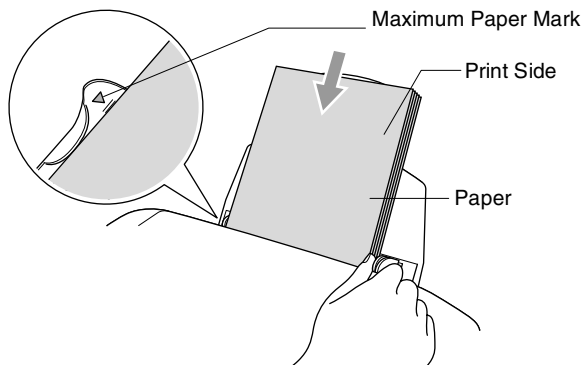

To load glossy paper

- 1 Fan the stack of glossy paper well.
- 2 Put a sheet of plain paper in the paper tray first, and then put the stack of glossy paper on top of it.



If the glossy sheets are 'double-feeding', put one sheet in the paper tray at a time.

To load envelopes

- 1 Before loading, press the corners and sides of the envelopes to make them as flat as possible.



If the envelopes are 'double-feeding', put one envelope in the paper tray at a time.

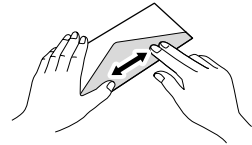
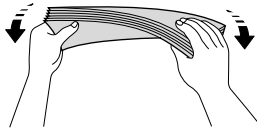
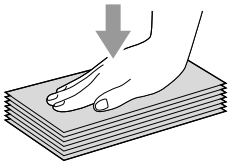

- 2 Press and slide the paper guide to fit the width of the envelopes. Insert them into the paper tray with the address side toward you and pointed in the direction below.

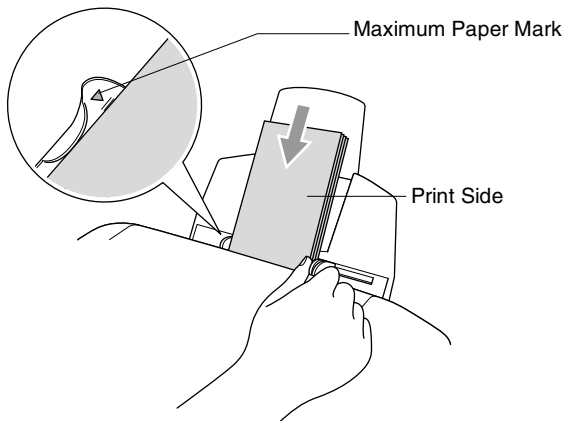

3

On-screen programming

User-friendly programming

Your machine is designed to be easy to use with LCD on-screen programming using the navigation keys. User-friendly programming helps you take full advantage of all the menu selections your machine has to offer.

Since your programming is done on the LCD, we have created step-by-step on-screen instructions to help you program your machine. All you need to do is follow the instructions as they guide you through the menu selections and programming options.

Menu table

You can probably program your machine without the User's Guide if you use the Menu table that begins on page 3-3. These pages will help you understand the menu selections and options that are found in the machine's programs.



You can program your machine by pressing **Menu/Set**, followed by the menu numbers.

For example to set **Fax Resolution** to **Fine**:

Press **Menu/Set**, **2**, **2**, **2** and  or  to select **Fine**.

Press **Menu/Set**.

Memory storage

If there is a power failure, you will not lose your menu settings because they are stored permanently. Temporary settings (such as Contrast, Overseas Mode, and so on) will be lost. You may also have to reset the date and time.

Navigation keys

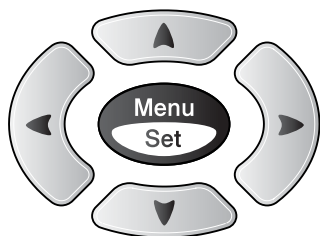

- * Access the menu
- * Go to the next menu level



- * Accept an option
- * Scroll through the current menu level



- * Go back to the previous menu level

Stop/
Exit



- * Exit the menu

You can access the menu mode by pressing **Menu/Set**.

When you enter the menu, the LCD scrolls.

Press **1** for General Setup menu

1.General Setup

—OR—

Press **2** for Fax menu

2.Fax

—OR—



Press **3** for Copy menu

3.Copy

⋮



Press **0** for Initial Setup

0.Initial Setup

You can scroll more quickly through each menu level by pressing the arrow for the direction you want:  or .

Then set an option by pressing **Menu/Set** when that option appears on the LCD.

The LCD will then show the next menu level.

Press  or  to scroll to your next menu selection.

Press **Menu/Set**.

When you finish setting an option, the LCD shows *Accepted*.



Use  to scroll backward if you passed your choices or want to save keystrokes.

Press the Menu numbers.
(ex. Press 1, 2 for Paper Type)

—OR—



Main Menu	Submenu	Menu Selections	Options	Descriptions	Page	
1.General Setup	1.Mode Timer	—	5 Mins 2 Mins 1 Min 30 Secs (MFC-3220C only) 0 Secs (FAX-1820C only) Off	Sets the time to return to Fax mode.	4-5	
	2.Paper Type	—	Plain Inkjet Glossy (4-Color or 3-Color) Transprncy	Sets the type of paper in the paper tray.	4-6	
	3.Paper Size	—	Letter Legal	Sets the size of paper in the paper tray.	4-6	
	4.Volume	1.Ring		High Med Low Off	Adjusts the ring volume.	4-7
		2.Beeper		High Med Low Off	Adjusts the volume level of the beeper.	4-7
		3.Speaker		High Med Low Off	Adjusts the speaker volume.	4-8
		4.Handset (FAX-1820 only)		High Low	Adjusts handset volume.	4-8



The factory settings are shown in Bold.

Press the Menu numbers.
(ex. Press 1, 2 for Paper Type)

—OR—



Main Menu	Submenu	Menu Selections	Options	Descriptions	Page
1.General Setup (Continued)	4.Volume (Continued)	5.Volume Amplify (FAX-1820C only)	On (Permanent/ Temporary) Off	For the hearing-impaired, you can set the volume to the VOL AMPLIFY; ON setting on a permanent or temporary basis.	4-10
	5.Auto Daylight	—	On Off	Changes for Daylight Savings Time automatically.	4-10
	6.On/Off Setting	—	Fax Receive: On Off	Customizes the On/Off key in order to receive fax even in OFF mode.	4-11
2.Fax	1.Setup Receive (In Fax mode only)	1.Ring Delay	04 03 02 01 00	Sets the number of rings before the machine answers in Fax or Fax/Tel mode.	5-2
		2.F/T Ring Time	70 Sec 40 Sec 30 Sec 20 Sec	Sets the pseudo/double-ring time in Fax/Tel mode.	5-3
		3.Easy Receive	On Semi (FAX-1820C only) Off	Receives fax messages without pressing the Black Start or Color Start key.	5-4 and 5-5
		4.Remote Code	On (* 51, #51) Off	You can answer all calls at an extension or external phone and use codes to turn the machine on or off. You can personalize these codes.	5-8



The factory settings are shown in Bold.

Press the Menu numbers.
(ex. Press 1, 2 for Paper Type)

—OR—



Main Menu	Submenu	Menu Selections	Options	Descriptions	Page
2.Fax (Continued)	1.Setup Receive (In Fax mode only) (Continued)	5.Auto Reduction	On Off	Reduces the size of incoming faxes.	5-6
		6.Polling RX		Sets up your machine to poll another fax machine.	5-9
	2.Setup Send (In Fax mode only)	1.Contrast	Auto Light Dark	Changes the lightness or darkness of faxes you send.	6-7
		2.Fax Resolution	Standard Fine S.Fine Photo	Sets the default resolution for outgoing faxes.	6-8
		3.Delayed Fax	—	Set the time of day in 24 hour format that the delayed faxes will be sent.	6-15
		4.Batch TX	On Off	Combines delayed faxes to the same fax number at the same time of day into one transmission.	6-17
		5.Real Time TX	Off On Next Fax Only	You can send a fax without using the memory.	6-10
		6.Polled TX	On Off	Sets up your machine with an original to be retrieved by another fax machine.	6-16
7.Overseas Mode	On Off	Adjusts for overseas transmissions, which can sometimes cause problems.	6-14		



The factory settings are shown in Bold.

Press the Menu numbers.
(ex. Press 1, 2 for Paper Type)

—OR—



Main Menu	Submenu	Menu Selections	Options	Descriptions	Page	
2.Fax (Continued)	3.Set Quick-Dial	1.One-Touch Dial		Stores One-Touch Dial numbers, so you can dial by pressing one key (and Start).	7-1	
		2.Speed-Dial	—	Stores Speed-Dial numbers, so you can dial by pressing only a few keys (and Start).	7-3	
		3.Setup Groups	—	Sets up a Group number for Broadcasting.	7-5	
	4.Report Setting	1.Transmission	On On+Image Off Off+Image	Initial setup for Transmission Verification Report and Fax Journal Report.	9-1	
		2.Journal Period	Every 7 Days Every 2 Days Every 24 Hours Every 12 Hours Every 6 Hours Every 50 Faxes Off		9-2	
	5.Remote Fax Opt	1.Fax Fwd/Paging	Off	Fax Forward Paging	Sets the machine to forward fax messages or to call your pager.	8-1 8-2
			2.Fax Storage		On Off	Stores incoming faxes in the memory so you can retrieve them while you are away from your machine.
		3.Remote Access	---*	You must set your own code for Remote Retrieval.	8-4	
		4.Print Fax (Backup Print)	—	Prints incoming faxes stored in the memory.	5-6 8-3	



The factory settings are shown in Bold.

Press the Menu numbers.
(ex. Press 1, 2 for Paper Type)

—OR—

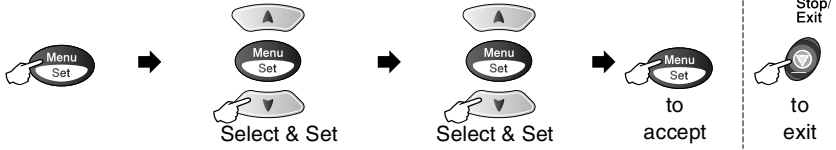

Main Menu	Submenu	Menu Selections	Options	Descriptions	Page
2.Fax (Continued)	6.Remaining Jobs	—	—	Checks which jobs are in the memory or cancels a delayed fax or polling job.	6-11
	0.Miscellaneous	1.Distinctive	Off Set (On)	Uses the Telephone Company's Distinctive Ring subscriber service to register the ring pattern with the machine.	5-10
		2.Caller ID	Display # Print Report	View or print a list of the last 30 Caller IDs stored in the memory.	5-14
		3.Call Waiting ID (FAX-1820C only)	On Off	Lets you use the telephone company's Call Waiting/Caller ID subscriber service.	5-15



The factory settings are shown in Bold.

Press the Menu numbers.
(ex. Press 1, 2 for Paper Type)

—OR—



Main Menu	Submenu	Menu Selections	Options	Descriptions	Page	
3.Copy	1.Quality		Best Normal Fast	Selects the Copy resolution for your type of original.	10-12	
	2.Brightness	—	- o o o o ■ + - o o o o □ + - o o o o ■ + - o ■ o o o + - ■ o o o o +	Adjusts the brightness.	10-12	
	3.Contrast	—	- o o o o ■ + - o o o o □ + - o o o o ■ + - o ■ o o o + - ■ o o o o +	Adjusts the contrast for copies.	10-12	
	4.Color Adjust	1.Red		R:- o o o o ■ + R:- o o o o □ + R:- o o o o ■ + R:- o o o o □ + R:- ■ o o o o +	Adjusts the amount of Red in copies.	10-13
		2.Green		G:- o o o o ■ + G:- o o o o □ + G:- o o o o ■ + G:- o o o o □ + G:- ■ o o o o +	Adjusts the amount of Green in copies.	
		3.Blue		B:- o o o o ■ + B:- o o o o □ + B:- o o o o ■ + B:- o o o o □ + B:- ■ o o o o +	Adjusts the amount of Blue in copies.	
	4.Test Print				You can print a test sample page to check the print quality and adjust the Vertical Alignment.	12-11



The factory settings are shown in Bold.

Press the Menu numbers.
(ex. Press 1, 2 for Paper Type)

—OR—

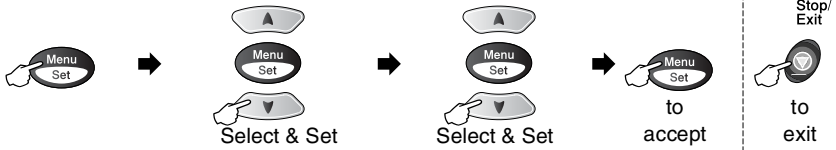

Main Menu	Submenu	Menu Selections	Options	Descriptions	Page
5.Print Reports	1.Help List	—	—	You can print these lists and reports.	9-3 and 9-4
	2.Quick-Dial	—	—		
	3.Fax Journal	—	—		
	4.Transmission	—	—		
	5.User Settings	—	—		
0.Initial Setup	1.Receive Mode	—	Fax Only Fax/Tel External TAD Manual	You can choose the receive mode that best suits your needs.	5-1 and 5-2
	2.Date/Time	—	—	Puts the date and time on the LCD and in headings of faxes you send.	4-1
	3.Station ID	—	Fax Name	Program your name and fax number to appear on each page you fax.	4-2
	4.Tone/Pulse	—	Tone Pulse	Selects the dialing mode.	4-4
	0.Local Language (Canada only)	—	English French	Allows you to change the LCD Language for your country.	See Quick Setup Guide



The factory settings are shown in Bold.

4 Getting started

Initial Setup

Setting the Date and Time

Your machine displays the date and time and if you set up the Station ID it prints on every fax you send. If there is a power failure, you may have to reset the date and time. All other settings will not be affected.

1 Press **Menu/Set, 0, 2.**

2 Enter the last two digits of the year.
Press **Menu/Set.**

3 Enter two digits for the month.
Press **Menu/Set.**
(For example, enter 09 for September, or 10 for October.)

4 Enter two digits for the day.
Press **Menu/Set.**
(For example, enter 06 for 6th.)

5 Enter the time in 24-Hour format.
Press **Menu/Set.**
(For example, enter 15:25 for 3:25 P.M.)

6 Press **Stop/Exit.**
The LCD now shows the date and time whenever the machine is in Fax mode.

Setting the Station ID

You should store your name or company name and fax number to be printed on all fax pages that you send.

1 Press **Menu/Set, 0, 3**.

3.Station ID

2 Enter your fax number (up to 20 digits).

Fax:

Press **Menu/Set**.



You cannot enter a hyphen.

3 Use the dial pad to enter your name (up to 20 characters).

Name:

Press **Menu/Set**.

4 Press **Stop/Exit**.

The LCD will go back standby mode automatically.



If the Station ID has already been programmed, the LCD will ask you to press **1** to make a change or **2** to exit without changing.

Entering text

When you are setting certain functions, such as the Station ID, you may need to type text into the machine. Most number keys have three or four letters printed above them. The keys for **0**, **#** and ***** do not have printed letters because they are used for special characters.

By pressing the appropriate number key repeatedly, you can access the character you want.

Press Key	one time	two times	three times	four times
2	A	B	C	2
3	D	E	F	3
4	G	H	I	4
5	J	K	L	5
6	M	N	O	6
7	P	Q	R	S
8	T	U	V	8
9	W	X	Y	Z

Inserting spaces

To enter a space, press  once between numbers and twice between characters.



Making corrections

If you entered a letter incorrectly and want to change it, press  to move the cursor under the incorrect character. Then press **Stop/Exit**. All letters above and to the right of the cursor will be deleted. Re-enter the correct character. You can also back up and type over incorrect letters.

Repeating letters

If you need to enter a character that is on the same key as the previous character, press  to move the cursor to the right before you press the key again.

Special characters and symbols

Press *****, **#** or **0**, and then press  or  to move the cursor under the special character or symbol you want. Then press **Menu/Set** to select it.



Press *	for	(space) ! " # \$ % & ' () * + , - . / €
Press #	for	: ; < = > ? @ [] ^ _
Press 0	for	É À È Ê Î Ç Ë Ö 0

NOTICE (For USA)

The Telephone Consumer Protection Act of 1991 makes it unlawful for any person to use a computer or electronic device to send any message via a telephone fax machine unless such messages clearly contain, in a margin at the top or bottom of each transmitted page, or on the first page of the transmission, the date and time it is sent and an identification of the business or other entity or other individual sending the message and the telephone number of the sending machines or such business, other entity or individual.

In order to program this information into your machine, complete the steps described on page 4-2.

Setting Tone and Pulse dialing mode

- 1 Press **Menu/Set**, **0**, **4**.
- 2 Press  or  to select **Pulse** (or **Tone**).
Press **Menu/Set**.
- 3 Press **Stop/Exit**.



4.Tone/Pulse

General Setup

Setting the Mode Timer (MFC-3220C only)

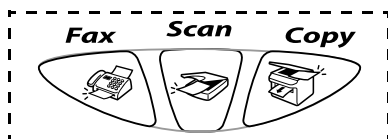
The machine has three temporary mode keys on the control panel: Fax, Copy and Scan. You can change the number of seconds or minutes the machine takes after the last Copy or Scan operation before it returns to Fax mode. If you select *Off*, the machine stays in the mode you used last.





- 1 Press **Menu/Set**, **1**, **1**. 1.Mode Timer
- 2 Press  or  to select
0 Sec, 30 Secs, 1 Min, 2 Mins, 5 Mins or Off.
- 3 Press **Menu/Set**.

Setting the Mode Timer (FAX-1820C only)

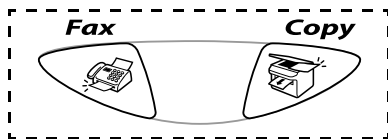
The machine has two temporary mode keys on the control panel: Fax and Copy. You can change the number of seconds or minutes the machine takes after the last Copy operation before it returns to Fax mode. If you select *Off*, the machine stays in the mode you used last.



- 1 Press **Menu/Set**, **1**, **1**. 1.Mode Timer
- 2 Press  or  to select
0 Sec, 30 Secs, 1 Min, 2 Mins, 5 Mins or Off.
- 3 Press **Menu/Set**.

Setting the Paper Type



To get the best print quality, set the machine for the type of paper you are using.

1 Press **Menu/Set**, **1**, **2**.

2.Paper Type

2 Press  or  to select Plain, Inkjet, Glossy or Transprncy.

Press **Menu/Set**.

3 If you selected Glossy, press  or  to select Glossy: 4-Color or Glossy: 3-Color.

Press **Menu/Set**.

 The print quality of black ink varies depending on the kind of glossy paper you are using. Black ink is used when you select Glossy: 4-Color. If the glossy paper you are using repels the black ink, select Glossy: 3-Color, which simulates black ink by combining the three ink colors.

4 Press **Stop/Exit**.

 The machine ejects paper with printed surfaces face up on the paper tray in the front of the machine. When you use transparencies or glossy paper, remove each sheet immediately to prevent smudging or paper jams.

Setting the Paper Size

You can use two sizes of paper for printing your faxes and copies: letter and legal. When you change the type of paper you load in the machine, you will need to change the setting for Paper Size at the same time so your machine can fit an incoming fax on the page.

1 Press **Menu/Set**, **1**, **3**.

3.Paper Size

2 Press  or  to select Letter or Legal.

Press **Menu/Set**.

3 Press **Stop/Exit**.



 For Copy Options, you can also change the paper size to photo card size (4" x 6") for the next copy only. (See *Paper Size* on page 10-8.)

Setting the Ring Volume

You can adjust the ring volume when your machine is idle (not being used). You can turn the ring **Off** or you can select the ring volume level.

1 Press **Menu/Set, 1, 4, 1.**



1.Ring

2 Press  or  to select (Low, Med, High or Off).

Press **Menu/Set.**

3 Press **Stop/Exit.**

—OR—

In Fax mode, press  or  to adjust the volume level. Every time you press these keys, the machine will ring so you can hear the active setting as the LCD shows it. The volume changes with each key press. The new setting will stay until you change it again.

Setting the Beeper Volume

You can change the beeper volume. The default (factory) setting is **Low**. When the beeper is on, the machine beeps every time you press a key or make a mistake and after a fax is sent or received.

1 Press **Menu/Set, 1, 4, 2.**

2.Beeper

2 Press  or  to select your option.

(Low, Med, High or Off)

Press **Menu/Set.**



3 Press **Stop/Exit.**

Setting the Speaker Volume

You can adjust the machine's one-way speaker volume.

1 Press **Menu/Set, 1, 4, 3.**

3.Speaker



2 Press  or  to select
(Low, Med, High or Off).

Press **Menu/Set.**

3 Press **Stop/Exit.**

—OR—



In Fax mode, you can adjust the speaker volume by pressing **Hook**, and then selecting a speaker volume level.

Press  or  to adjust the volume level. The LCD shows the setting you are choosing. Each key press changes the volume to the next setting. The new setting will remain until you change it again.

Setting the Handset Volume (FAX-1820C only)

1 Press **Menu/Set, 1, 4, 4.**

4.Handset



2 Press  or  to select
(High or Low).

Press **Menu/Set.**

3 Press **Stop/Exit.**

—OR—



You can adjust the handset volume any time you are talking on the telephone. There are two handset volume levels, **LOW** and **HIGH**. The default setting is **LOW**.

Press  or  to adjust the volume level. The LCD shows the setting you are choosing. The new setting will remain until you change it again.



Choosing the Handset Volume (For Volume Amplify) (FAX-1820C only)

Before you begin to use the machine, you must decide if you need to set the handset volume to `Vol Amplify:On` for a user who is hearing-impaired. The AMPLIFY volume level complies with FCC standards.



`Volume Amplify:Off`

This default setting is appropriate if *none* of the users are hearing-impaired. During a conversation, users can press Volume  or  on the control panel to adjust the volume to `Low` or `High`. When the handset is replaced, the handset volume will remain until you change it again.



`Volume Amplify:On—Temporary`

This setting is appropriate if *some* of the users are hearing-impaired. During a conversation, users can press Volume  or  on the control panel to adjust the volume to `Low`, `High` or `Amplify`. When the handset is replaced, the handset volume returns to the default setting of `Low`.

`Volume Amplify:On—Permanent`

Choose `Vol Amplify:On—Permanent` if *all* of the users are hearing-impaired. During a conversation, users can press Volume  or  on the control panel to adjust the volume to `Low`, `High` or `Amplify`. When the handset is replaced, the handset volume returns to the default setting of `Amplify`.







When you press Volume  or  on the control panel to adjust the volume, the LCD shows the setting you are choosing. Each key press changes the volume to the next setting.

WARNING

It is important that you do NOT choose `Permanent` unless ALL the users are hearing-impaired. Otherwise, the default setting of `Amplify` may damage the hearing of some users.



Setting Volume Amplify (FAX-1820C only)

Please carefully read *Choosing the Handset Volume* on page 4-9 before you do the following steps:

- 1 Press **Menu/Set**, **1**, **4**, **5**. 5.Volume Amplify
- 2 If *none* of the users are hearing-impaired, press  or  to select **Off**, and then press **Menu/Set** and go to Step 4. Vol Amplify: Off
—OR—
If *some* or *all* of the users are hearing-impaired, select **On**, and then press **Menu/Set**.
- 3 If all the users are hearing-impaired, press  or  to select **Permanent**, and then press **Menu/Set**. Permanent
—OR—
If only *some* of the users are hearing-impaired, select **Temporary**, and then press **Menu/Set**. Temporary
- 4 Press **Stop/Exit**.

Turning on Automatic Daylight Savings Time

You can set the machine to change automatically for Daylight Savings Time. It will reset itself forward one hour in the Spring and backward one hour in the Fall. Make sure you have set the correct day and time in the **Date/Time** setting.

- 1 Press **Menu/Set**, **1**, **5**. 5.Auto Daylight
- 2 Press  or  to select **On** (or **Off**).
Press **Menu/Set**.
- 3 Press **Stop/Exit**.

On/Off Setting

You can customize the machine's **On/Off** key. The default setting is **Off**. Your machine will not work when it is switched **Off**, but it will purge the ink head periodically. If you turn this setting to **On**, you can receive faxes or calls even when the machine is switched **Off**.

1 Press **Menu/Set, 1, 6**.

6.On/Off Setting

2 Press  or  to select **On** (or **Off**).

3 Press **Menu/Set**.

5 Setup Receive

Basic receiving operations

Choosing the Receive Mode

There are four different Receive Modes for your machine. You can choose the mode that best suits your needs.

LCD	How it works	When to use it
Fax Only (automatic receive)	The machine automatically answers every call as a fax.	For dedicated fax lines.
Fax/Tel* (fax and telephone) (with an external or extension telephone)	The machine controls the line and automatically answers every call. If the call is a fax it will receive the fax. If the call is not a fax it will ring (pseudo/double ring) for you to pick up the call.	Use this mode if you expect to receive lots of fax messages and few telephone calls. You cannot have an answering machine on the same line, even if it is on a separate wall jack on the same line. You cannot use the telephone company's Voice Mail in this mode.
External TAD (with an external answering device)	The external answering device (TAD) automatically answers every call. Voice messages are stored on the external TAD. Fax messages are printed.	Use this mode if you have connected an answering machine on your phone line. The TAD setting works only with an external answering machine. Ring Delay and F/T Ring Time do not work in this setting.
Manual (manual receive) (with an external or extension telephone or with Distinctive Ring)	You control the phone line and must answer every call yourself.	Use this mode when you are using a computer modem on the same line or if you don't receive many fax messages or with Distinctive Ring. If you answer and hear fax tones, wait until the machine takes over the call, then hang up.



* In Fax/Tel mode you must set the Ring Delay and F/T Ring Time.

To select or change your Receive Mode

1 If it is not illuminated in green, press  **(Fax)**.

2 Press **Menu/Set, 0, 1**.

1.Receive Mode

3 Press  or  to select

Fax Only, Fax/Tel, External TAD or Manual.

Press **Menu/Set**.

4 Press **Stop/Exit**.



If you are changing the Receive Mode while in another operation, the LCD will return to that operation.

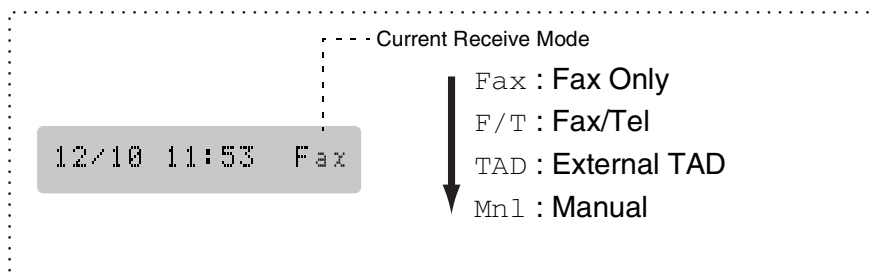

Setting the Ring Delay

The Ring Delay sets the number of times the machine rings before it answers in Fax only or Fax/Tel mode. If you have extension phones on the same line as the machine or subscribe to the telephone company's Distinctive Ring service, keep the Ring Delay setting of 4.

(See *Easy Receive (MFC-3220C only)* on page 5-4 or *Easy Receive (FAX-1820C only)* on page 5-5.)

1 If it is not illuminated in green, press  **(Fax)**.

2 Press **Menu/Set, 2, 1, 1**.

1.Ring Delay

3 Press  or  to select how

many times the line rings before the machine answers (00, 01, 02, 03 or 04).

Press **Menu/Set**.

(If you select 00, the line won't ring at all.)

4 Press **Stop/Exit**.

Setting the F/T Ring Time (Fax/Tel mode only)



If you set the Receive Mode to Fax/Tel, you'll need to decide how long the machine will signal you with its special pseudo/double-ring when you have a *voice* call. (If it's a fax call, the machine prints the fax.)

This pseudo/double-ring happens after the initial ringing from the phone company. Only the machine rings and no other phones on the same line will ring with the special pseudo/double-ring. However, you can still answer the call on the same line as the machine (FAX-1820C only) or on any extension phone (in a separate wall jack) on the same line as the machine. (See *Operation from extension telephones* on page 5-7.)

1 If it is not illuminated in green, press  **(Fax)**.

2 Press **Menu/Set**, **2**, **1**, **2**.

2.F/T Ring Time

3 Press  or  to select how long the machine will ring to alert you that you have a voice call (20, 30, 40 or 70 seconds).

Press **Menu/Set**.

4 Press **Stop/Exit**.

 Even if the caller hangs up during the pseudo/double-ringing, the machine will continue to ring for the set time.

Easy Receive (MFC-3220C only)

When you use this feature, you don't have to press **Black Start**, **Color Start**, or the Fax Receive Code *51 when you answer a fax call. Selecting **On** allows the machine to receive fax calls automatically, even if you lift the handset of an extension or external phone. When you see *Receiving* on the LCD or when you hear 'chirps' through the handset of an extension phone connected to another telephone wall jack, just replace the handset and your machine will do the rest. Selecting **Off** means you'll have to activate the machine yourself by lifting the handset of an external or extension phone, and then press **Black Start** or **Color Start** on the machine—**OR**—by pressing *51 if you are not at your machine. (See *Operation from extension telephones* on page 5-7.)



If this feature is set to **On**, but your machine doesn't connect a fax call when you lift a extension or external phone handset, press the Fax Receive Code *51.

If you send faxes from a computer on the same phone line and the machine intercepts them, set Easy Receive to **Off**.

1 If it is not illuminated in green, press  **(Fax)**.

2 Press **Menu/Set, 2, 1, 3**.

3.Easy Receive

3 Use  or  to select **On** (or **Off**).

Press **Menu/Set**.

4 Press **Stop/Exit**.

Easy Receive (FAX-1820C only)

When you use this feature, you don't have to press **Black Start**, **Color Start**, or the Fax Receive Code * 5 1 when you answer a fax call and hear calling beeps. Just hold the handset and wait a few seconds. When you see *Receiving* on the LCD or when you hear "chirps" through the handset of an extension phone connected to another wall jack, just replace the handset. Your machine does the rest. Selecting *On* allows the machine to receive fax calls automatically, even if you lift the handset of an extension or external phone. Selecting *Semi* lets the machine receive the call only if you've answered it at the machine. Selecting *Off* means you'll have to activate the machine yourself, by pressing **Black Start** or **Color Start** or by pressing * 5 1 if you are not at your machine. (See *Operation from extension telephones* on page 5-7 and *For Fax/Tel mode only* on page 5-7.)



If you've set the feature to *ON*, but your machine doesn't automatically connect a fax call when you lift an external or extension phone handset, press the Fax Receive code * 5 1. At the machine, lift the handset and then press **Black Start** or **Color Start**.



If you send faxes from a computer on the same phone line and the machine intercepts them, set Easy Receive to *Off*.



1

If it is not illuminated in green, press  **(Fax)**.

2

Press **Menu/Set**, **2**, **1**, **3**.

3

Use  or  to select *On*, *Semi*, or *Off*.

Press **Menu/Set**.

4

Press **Stop/Exit**.

3.Easy Receive

Printing a reduced incoming fax (Auto Reduction)

If you choose **On**, the machine automatically reduces an incoming fax to fit on one page of letter or legal size paper. The machine calculates the reduction ratio by using the page size of the original and your Paper Size setting (**Menu/Set, 1, 3**).

1 If it is not illuminated in green, press  (**Fax**).

2 Press **Menu/Set, 2, 1, 5**.

5.Auto Reduction

3 Use  or  to select **On** (or **Off**).

Press **Menu/Set**.

4 Press **Stop/Exit**.



If you receive faxes that are split on two pages, turn on this setting. But if the original is too long, the machine may print it on two pages.

Receiving a fax at the end of a conversation (FAX-1820C only)

At the end of a conversation you can ask the other party to fax you information before you both hang up.

1 Ask the other party to place the original in their machine and to press **Start**. Tell the other party to wait until your machine sends receiving tones (chirps) before hanging up.

2 When you hear the other machine's CNG tones (beeps), press **Black Start** or **Color Start**.

3 If you picked up the handset, replace it.

Printing a fax from the memory

If you set Fax Storage to **ON** for Remote Retrieval, you can still print a fax from the memory when you are at your machine. (See *Setting Fax Storage* on page 8-3.)

1 Press **Menu/Set, 2, 5, 4**.

4.Print Fax

2 Press **Black Start** or **Color Start**.

3 After printing has finished, press **Stop/Exit**.

Advanced receiving operations

Operation from extension telephones

If you answer a fax call on an extension telephone, or an external telephone in the EXT. jack of the machine, you can make your machine take the call by using the Fax Receive Code. When you press the Fax Receive Code ***51**, the machine starts to receive a fax.

(See *Easy Receive (MFC-3220C only)* on page 5-4 or *Easy Receive (FAX-1820C only)* on page 5-5.)

If the machine answers a voice call and pseudo/double-rings for you to take over, use the Telephone Answer Code **#51** to take the call at an extension phone. (See *Setting the F/T Ring Time (Fax/Tel mode only)* on page 5-3.)

If you answer a call and no one is on the line, you should assume that you're receiving a manual fax.

- Press ***51** and wait for the chirp or until the machine's LCD displays Receiving, and then hang up.

Your caller will have to press **Start** to send the fax.

For Fax/Tel mode only

When the machine is in Fax/Tel mode, it will use the F/T Ring Time (pseudo/double-ringing) to alert you to pick up a voice call.

If you're at the machine, you can lift the handset to answer. (FAX-1820C only).

Lift the external telephone's handset, and then press **Hook** to answer.

If you're at an extension phone, you'll need to lift the handset during the F/T Ring Time and then press **#51** between the pseudo/double rings. If no one is on the line, or if someone wants to send you a fax, send the call back to the machine by pressing ***51**.

Using a cordless external handset

If your cordless telephone is connected to the EXT. jack on the machine and you typically carry the cordless handset elsewhere, it is easier to answer calls during the Ring Delay. If you let the machine answer first, you will have to go to the machine so you can press **Hook** to transfer the call to the cordless handset.

Changing the remote codes

Remote Codes might not work with some telephone systems. The preset Fax Receive Code is *51. The preset Telephone Answer Code is #51.

 If you are always disconnected when accessing your external TAD remotely, try changing the Fax Receive Code and Telephone Answer Code to another three-digit code (such as ### and 999).

1 If it is not illuminated in green, press  **(Fax)**.

2 Press **Menu/Set, 2, 1, 4**.

4.Remote Code

3 Press  or  to select On (or Off).

Press **Menu/Set**.

4 If you want to, enter a new Fax Receive Code.

Press **Menu/Set**.

5 If you want to, enter a new Telephone Answer Code.

Press **Menu/Set**.

6 Press **Stop/Exit**.

Polling

Polling is the process of retrieving faxes from another fax machine. You can use your machine to 'poll' other machines, or you can have someone poll your machine.

Everyone who is involved in Polling needs to set up their fax machines for Polling. When someone polls your machine to receive a fax, they pay for the call. If you poll someone's fax machine to receive a fax, you pay for the call.



Some fax machines do not respond to the Polling feature.

Setting up Polling Receive

Polling Receive is when you call another fax machine to receive a fax from it.

1 If it is not illuminated in green, press  **(Fax)**.

2 Press **Menu/Set, 2, 1, 6**.

6.Polling RX

3 Enter the fax number you are polling.

4 Press **Black Start** or **Color Start**.

The LCD shows *Dialing*.

Setting up Sequential Polling Receive

Your machine can ask for faxes from several fax units in a single operation (Sequential Polling Receive). Afterwards, a Sequential Polling Report will be printed.

1 If it is not illuminated in green, press  **(Fax)**.

2 Press **Menu/Set, 2, 1, 6**.

6.Polling RX

3 Enter the fax machines you want to poll using One-Touch, Speed-Dial, a Group or the dial pad. You must press **Menu/Set** between each fax number.

4 Press **Black Start** or **Color Start**. Your machine will poll each number or Group number in turn to receive a fax.

Telephone services

Your machine supports the Distinctive Ring telephone service that some telephone companies offer.



If you have Voice Mail, RingMaster, an answering service, an alarm system or other custom features on your telephone line, it may affect the way your machine works. (See *Custom features* on page 1-7 and *Custom features on a single line* on page 12-9.)

If you have Voice Mail on your phone line, please read the following carefully.

Distinctive Ring

Brother uses the term 'Distinctive Ring' but different telephone companies have other names for this service such as SmartRing, RingMaster, Teen-Ring, Indent-a-Call or Indent-a-Ring.

What does your telephone company's 'Distinctive Ring' do?

Your telephone company's Distinctive Ring service allows you to have more than one number on the same phone line. **If you need more than one phone number, it is cheaper than paying for an extra line.** Each phone number has its own distinctive ring pattern, so you will know which phone number is ringing. This is one way you can have a separate phone number for your machine.



Please call your telephone company for availability and rates.

What does Brother's 'Distinctive Ring' do?

The Brother machine has a Distinctive Ring feature that allows you to use your machine to take full advantage of the telephone company's Distinctive Ring service. The new phone number on your line can just receive faxes.



You must pay for your telephone company's Distinctive Ring service before you program the machine to work with it.

Do you have Voice Mail?

If you have Voice Mail on the phone line that you will install your new machine on, *there is a strong possibility that Voice Mail and the machine will conflict with each other while receiving incoming calls.* **However, the Distinctive Ring feature allows you to use more than one number on your line, so both Voice Mail and the machine can work together without any problems.** If each one has a separate phone number, neither will interfere with the other's operations.





If you decide to get the Distinctive Ring service from the telephone company, you will need to follow the directions below to 'register' the new Distinctive Ring pattern they give you. This is so your machine can recognize its incoming calls.



You can change or cancel the Distinctive Ring pattern at any time. You can switch it off temporarily, and turn it back on later. When you get a new fax number, make sure you reset this feature.

Before you choose the ring pattern to register

You can only register one Distinctive Ring pattern with the machine. Some ring patterns cannot be registered. The ring patterns below are supported by your Brother machine. Register the one your telephone company gives you.

Ring Pattern	Rings	
1	long-long	
2	short-long-short	
3	short-short-long	
4	very long (normal pattern)	



If the ring pattern you received is not on this chart, **please call your telephone company and ask for one that is shown.**

- The machine will only answer calls to its registered number.
- The first two rings are silent on the machine. This is because the fax must «listen» to the ring pattern (to compare it to the pattern that was ‘registered’). (Other telephones on the same line will ring.)
- If you program the machine properly, it will recognize the registered ring pattern of the ‘fax number’ within 2 ring patterns and then answer with a fax tone. When the ‘voice number’ is called, the machine will not answer.

Registering the Distinctive Ring pattern

Very important!



After you have set the Distinctive Ring feature to ON, the receive mode is set to `Manual` automatically. Unless you have a TAD or Voice Mail set up on the Distinctive Ring number, `Manual` mode means you must answer all the calls yourself. You can not change the receive mode to the other mode while the Distinctive Ring is set to on.

1 Press **Menu/Set, 2, 0, 1.**

1.Distinctive

2 Press  or  to select `Set`.

Press **Menu/Set**.

3 Press  or  to select the stored ring pattern you want to use.



Press **Menu/Set**.

(You will hear each pattern as you scroll through the four patterns. Make sure you choose the pattern that the telephone company gave you.)

4 Press **Stop/Exit**.

Distinctive Ring is now set to on.

Turning off the Distinctive Ring

- 1** Press **Menu/Set, 2, 0, 1.**
- 2** Press  or  to select **Off.**
Press **Menu/Set.**
- 3** Press **Stop/Exit.**

1.Distinctive



If you turn off Distinctive Ring, the machine will stay in **Manual** receive mode. You will need to set the **Receive Mode** again.
(See *To select or change your Receive Mode* on page 5-2.)

Caller ID



The Caller ID feature lets you use the Caller ID subscriber service offered by many local telephone companies. This service displays the telephone number, or name if it is available, of your caller as the line rings.

After a few rings, the LCD shows the telephone number of your caller (or name, if available). Once you pick up the handset, the Caller ID information disappears from the LCD, but the call information remains stored in the Caller ID memory.

- You will see the first 16 characters of the number (or name).
- `Out of Area` display means call originated outside your Caller ID service area.
- `Private Call` display means the caller has intentionally blocked transmission of information.

If both the name and number are received, the LCD shows only the name. You can print a list of Caller ID information received by your machine. (See *Printing Caller ID List* on page 5-15.)



Caller ID service varies with different carriers. Call your local telephone company to determine the kind of service available in your area.

Viewing Caller ID List

Caller ID memory stores information for up to thirty calls. When the thirty-first call comes in, information about the first call is erased. You can scroll through Caller ID information to review those calls made to your machine.



1 Press **Menu/Set**, **2**, **0**, **2**.



2.Caller ID

2 Press  or  to select
Display #.



Press **Menu/Set**.

If the name was not received, it will not be displayed.

3 Press  or  to scroll through the Caller ID memory to select the Caller ID you want to view, and then press **Menu/Set**. The LCD shows the caller's name and number and the date and time of the call.

- 4 Press  or  to return to the Caller ID listing.
—OR—
Press **Stop/Exit**.



Printing Caller ID List

- 1 Press **Menu/Set, 2, 0, 2.** 2.Caller ID
- 2 Press  or  to select
Print Report.
Press **Menu/Set**.
- 3 Press **Black Start** or **Color Start**.
- 4 After printing has finished, press **Stop/Exit**.

Call Waiting Caller ID (FAX-1820C only)

The Call Waiting/Caller ID feature lets you use the Call Waiting/Caller ID service offered by many local telephone companies. This feature displays the telephone number (or name, if available) of Call Waiting Callers on your fax machine's LCD.

To set the Call Waiting Caller ID to On (or Off):

- 1 Press **Menu/Set, 2, 0, 3.** 3.CallWaiting ID
- 2 Press  or  to select
On (or Off).
Press **Menu/Set**.

To answer a Call Waiting signal:

- 3 To answer a Call Waiting signal while you're talking on the phone, ask the other party if you can put them on Hold to catch the other call. The LCD shows the Caller ID.
- 4 Press **Search/Speed Dial** to switch to the second call.
- 5 To switch back to the first call, press **Search/Speed Dial** again.



 Either caller can hang up at any time. However, if you hang up you will disconnect both callers.

6 Setup Send

How to fax

You can send faxes from the ADF (automatic document feeder).

Enter Fax mode

Before sending faxes, make sure  **(Fax)** is illuminated in green. If not, press  **(Fax)** to enter Fax mode. The default setting is Fax.

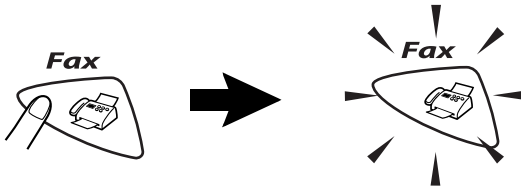

How to dial

There are four ways to dial.

Manual dialing

Press all of the digits of the phone or fax number.



One-Touch dialing

Press the One-Touch Key of the location you want to call. (See *Storing One-Touch Dial numbers* on page 7-1.)

To dial One-Touch numbers 6 to 10, hold down **Shift** as you press the One-Touch Key.

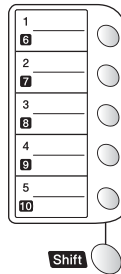

 If the LCD shows `Not Registered` when you press the One-Touch key, number has not been stored on it.

Speed-Dialing

Press **Search/Speed Dial**, **#**, and then the two digit Speed-Dial number. (See *Storing Speed-Dial numbers* on page 7-3.)



 If the LCD shows `Not Registered` when you enter the Speed-Dial number, a number has not been stored for it.

Search

You can search for names you have stored in the One-Touch and Speed-Dial memories. Press **Search/Speed Dial** and the navigation keys to search. (See *Storing One-Touch Dial numbers* on page 7-1 and *Storing Speed-Dial numbers* on page 7-3.)

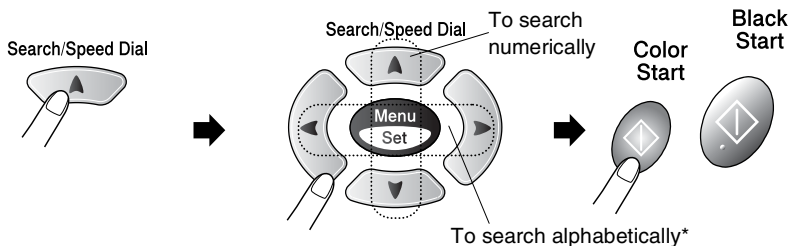

* To search alphabetically, you can use dial pad to enter the first letter of the name you are looking for.

Out of Memory message

If you get an **Out of Memory** message while scanning the first page of a fax, press **Stop/Exit** to cancel the scan. If you get an **Out of Memory** message while scanning a subsequent page, you will have the option to press **Black Start** to send the pages scanned so far, or to press **Stop/Exit** to cancel the operation.



If the memory is full and you are faxing a single page, it will be sent in real time.

Automatic transmission (MFC-3220C only)

This is the easiest way to send a fax.

 Do not pick up the hand set of the external phone or press **Hook** to listen for a dial tone

- 1 If it is not illuminated in green, press  (**Fax**).
- 2 Load your original. (See *Load originals* on page 2-1.)
- 3 Enter the fax number using the dial pad, One-Touch, Speed-Dial or Search.
(See *How to dial* on page 6-1.)
- 4 Press **Black Start** or **Color Start**.

Automatic transmission (FAX-1820C only)

This is the easiest way to send a fax.

 Do not pick up the hand set of the machine or the external phone or press **Hook** to listen for a dial tone

- 1 If it is not illuminated in green, press  (**Fax**).
- 2 Load your original. (See *Load originals* on page 2-1.)
- 3 Enter the fax number using the dial pad, One-Touch, Speed-Dial or Search.
(See *How to dial* on page 6-1.)
- 4 Press **Black Start** or **Color Start**.

Manual transmission (MFC-3220C only)

Manual transmission lets you hear the dialing, ringing and fax-receiving tones while sending a fax.

- 1 If it is not illuminated in green, press  **(Fax)**.
- 2 Load your original. (See *Load originals* on page 2-1.)
- 3 Pick up the handset of the external phone and listen for a dial tone.
—OR—
Press **Hook** and listen for a dial tone.
- 4 On the external phone, dial the fax number you want to call.
—OR—
If you pressed **Hook**, dial using the machine's control panel.
- 5 When you hear the fax tone, press **Black Start** or **Color Start**.
- 6 If you picked up the handset of the external phone, replace it.

Manual transmission (FAX-1820C only)

Manual transmission lets you hear the dialing, ringing and fax-receiving tones while sending a fax.

- 1 If it is not illuminated in green, press  **(Fax)**.
- 2 Load your original. (See *Load originals* on page 2-1.)
- 3 Pick up the machine's handset and listen for a dial tone.
—OR—
Press **Hook** and listen for a dial tone.
- 4 Dial the fax number you want to call.
- 5 When you hear the fax tone, press **Black Start** or **Color Start**.
- 6 If you picked up the machine's handset, replace it.

Sending a fax at the end of a conversation (FAX-1820C only)

At the end of a conversation you can send a fax to the other party before you both hang up.

- 1** Ask the other party to wait for fax tones (beeps) and then to press **Start** before hanging up.
- 2** If it is not illuminated in green, press  (**Fax**).
- 3** Load your original. (See *Load originals* on page 2-1.)
- 4** Press **Black Start** or **Color Start**.
- 5** Replace the handset.

Basic sending operations

Sending faxes using multiple settings

When you send a fax you can choose any combination of these settings: contrast, resolution, overseas mode, delayed fax timer, polling transmission or real time transmission.

1 If it is not illuminated in green, press  (**Fax**) before pressing **Menu/Set**. After each setting is accepted, the LCD will ask if you want to enter more settings:

2 Press **1** to select more settings. The LCD will return to the `Setup Send` menu.

Other Settings

1.Yes 2.No

—OR—

Press **2** if you have finished choosing settings and go to the next step.

Contrast

If your original is very light or very dark, you may want to set the contrast.

Use `Light` to send a light document or make the fax darker.

Use `Dark` to send a dark document or make the fax lighter.

1 If it is not illuminated in green, press  (**Fax**).

2 Load your original. (See *Load originals* on page 2-1.)

3 Press **Menu/Set**, **2**, **2**, **1**.

1.Contrast

4 Press  or  to select `Auto`, `Light` or `Dark`.

Press **Menu/Set**.

5 Press **1** if you want to choose more settings and the LCD will return to the `Setup Send` menu.



—OR—

Press **2** if you have finished choosing settings.

6 Enter a fax number.

Press **Black Start** or **Color Start**.

Fax Resolution

You can use the **Fax Resolution** key to change the setting temporarily (for this fax only). Press **Fax Resolution** and  or  to select the setting you want, and then press **Menu/Set**.

—OR—



You can change the default setting.

1 If it is not illuminated in green, press  (**Fax**).

2 Load your original. (See *Load originals* on page 2-1.)

3 Press **Menu/Set, 2, 2, 2**.

2.Fax Resolution

4 Press  or  to select the resolution you want.

Press **Menu/Set**.

5 Press **Stop/Exit**.

Standard _____ Suitable for most typed originals.

Fine _____ Good for small print and transmits a little slower than Standard resolution.

S. Fine _____ Good for small print or artwork and transmits slower than Fine resolution.

Photo _____ Use when the original has varying shades of gray or photograph. This has the slowest transmission time.

Manual and automatic fax Redial

If you are sending a fax manually and the line is busy, press **Redial/Pause**, and then press **Black Start** or **Color Start** to try again. If you want to make a second call to the last number dialed, you can save time by pressing **Redial/Pause** and **Black Start** or **Color Start**.

Redial/Pause only works if you dialed from the control panel.

If you are sending a fax automatically and the line is busy, the machine will automatically redial one time after five minutes.

Color fax transmission

Your machine can send a color fax to machines that support this feature.

However, color faxes cannot be stored in the memory, so Delayed fax and Polling Transmit features are not available.

- 1** If it is not illuminated in green, press  **(Fax)**.
- 2** Load your original. (See *Load originals* on page 2-1.)
- 3** Enter the fax number using the dial pad, One-Touch, Speed-Dial or Search.
- 4** Press **Color Start**.



When you send a color fax, the machine will send it in real time (even if `Real Time TX` is set to `Off`).

Dual Access (Not available for color faxes)

You can dial a number, and begin scanning the fax into memory—even when the machine is sending from memory or receiving faxes. The LCD shows the new job number and available memory.



Your machine normally uses Dual Access. However, to send a color fax, the machine will send the original in real time (even if *Real Time TX* is Off).

The number of pages you can scan into the memory will vary depending on the data that is printed on them.



If you get a *Out of Memory* message while scanning the first page of a fax, press **Stop/Exit** to cancel scanning. If you get a *Out of Memory* message while scanning a subsequent page, you can press **Black Start** to send the pages scanned so far, or press **Stop/Exit** to cancel the operation.

Real Time Transmission

When you are sending a fax, the machine will scan the originals into the memory before sending. Then, as soon as the phone line is free, the machine will start dialing and sending.

If the memory becomes full, the machine will send the original in real time (even if *Real Time TX* is set to Off).

Sometimes, you may want to send an important original immediately, without waiting for memory transmission. You can set *Real Time TX* to On for all documents or for the next fax only.

If you want to fax multiple pages, use Dual Access.



(See *Dual Access (Not available for color faxes)* on page 6-10.)

1 If it is not illuminated in green, press  **(Fax)**.

2 Load your original. (See *Load originals* on page 2-1.)

3 Press **Menu/Set, 2, 2, 5**.



5.Real Time TX

- 4** To change the default setting, press  or  to select On (or Off).



Press **Menu/Set**.

Go to Step 6.

—OR—

For the next fax transmission only, press  or  to select Next Fax Only.

Press **Menu/Set**.

- 5** Press  or  to select Next Fax:On (or Next Fax:Off).

Press **Menu/Set**.

- 6** Press **1** if you want to choose more settings and the LCD will return to the Setup Send menu.

—OR—

Press **2** if you have finished choosing settings.

- 7** Enter a fax number.

Press **Black Start** or **Color Start**.



In Real Time Transmission, the redial feature doesn't work.





If you are sending a color Fax, the machine will send it in real time (even if Real Time TX is set to Off).

Checking job status

Check which jobs are still waiting in the memory to be sent. (If there are no jobs, the LCD shows No Jobs Waiting.)

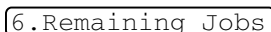
- 1** Press **Menu/Set, 2, 6**.



- 2** If you have more than one job waiting, press  or  to scroll through the list.

- 3** Press **Stop/Exit**.

Canceling a job while scanning, dialing and sending the original

You can cancel a job while you are scanning it into memory by pressing **Stop/Exit**.

You can also cancel a job while the machine is dialing or sending the original by pressing **Stop/Exit**.



Canceling a scheduled job

You can cancel a fax job that is stored and waiting in memory.

1 Press **Menu/Set**, **2**, **6**.

6.Remaining Jobs

Any jobs that are waiting will appear on the LCD.

2 If you have more than two jobs waiting, press  or  to select the job you want to cancel.

Press **Menu/Set**.

—OR—

If you only have one job waiting, go to Step 3.

3 Press **1** to cancel.

—OR—

Press **2** to exit without canceling.

To cancel another job go to Step 2.

4 Press **Stop/Exit**.

Advanced sending operations

Broadcasting (Not available for color faxes)

Broadcasting is when the same fax message is automatically sent to more than one fax number. Using the **Menu/Set** key, you can include Groups, One-Touch, Speed-Dial numbers and up to 50 manually dialed numbers. If you did not use up any of the numbers for Groups, access codes or credit card numbers, you can 'broadcast' faxes to as many as 100 different numbers. However, the available memory will vary depending on the types of jobs in the memory and the number of locations used for broadcasting. If you broadcast to the maximum numbers available, you will not be able to use Dual Access and Delayed fax.

To include One-Touch or Speed-Dial numbers and manually dialed numbers in the same broadcast, you must press **Menu/Set** between each of the numbers. Use **Search/Speed Dial** to help you choose the numbers easily.

(See *Setting up Groups for Broadcasting* on page 7-5.)

After the broadcast is finished, a Broadcast Report will be printed to let you know the results.

- Enter the long dialing sequence numbers as you would normally, but remember that each One-Touch and Speed-Dial number counts as one number, so the number of locations you can store becomes limited.
- If the memory is full, press **Stop/Exit** to stop the job or if more than one page has been scanned, press **Black Start** to send the portion that is in the memory.

1 If it is not illuminated in green, press  (**Fax**).

2 Load your original. (See *Load originals* on page 2-1.)

3 Enter a number using One-Touch, Speed-Dial, a Group number, Search or manual dialing using the dial pad.
(Example: Group number)



4 When the LCD displays the fax number or name of the other party, press **Menu/Set**.

You will be asked to press the next number.

- 5 Enter the next number.
(Example: Speed-Dial number)
- 6 When the LCD displays the fax number or name of the other party, press **Menu/Set**.
- 7 Enter another fax number.
(Example: Manual dialing using the dial pad.)
- 8 Press **Black Start**.

Overseas Mode

If you are having difficulty sending a fax overseas due to possible interference on the phone line, we recommend that you turn on the Overseas Mode. After you send a fax using this feature, the feature will turn itself off.

- 1 If it is not illuminated in green, press  (**Fax**).
- 2 Load your original. (See *Load originals* on page 2-1.)
- 3 Press **Menu/Set, 2, 2, 7**. 7.Overseas Mode
- 4 Press  or  to select On (or Off).
Press **Menu/Set**.
- 5 Press **1** if you want to choose more settings and the LCD will return to the *Setup Send* menu.
—OR—
Press **2** if you have finished choosing settings.
- 6 Enter a fax number.
Press **Black Start** or **Color Start**.

Delayed Fax (Not available for color faxes)

During the day you can store up to 50 faxes in the memory to be sent within 24 hours. These faxes will be sent at the time of day you enter in Step 4. Press **Menu/Set** to accept it, or enter another time for the faxes to be sent.

1 If it is not illuminated in green, press  (**Fax**).

2 Load your original. (See *Load originals* on page 2-1.)

3 Press **Menu/Set**, **2**, **2**, **3**.

3.Delayed Fax

4 Enter the time you want the fax to be sent (in 24-hour format).

Press **Menu/Set**.

(For example, enter 19:45 for 7:45 PM.)

Press **1** to leave the originals waiting in the ADF.

1.Doc 2.Memory

—OR—

Press **2** to scan the original into memory.

5 Press **1** if you want to choose more settings and the LCD will return to the *Setup Send* menu.

—OR—

Press **2** if you have finished choosing settings.





6 Enter a fax number.

Press **Black Start**.

 *The number of pages you can scan into the memory depends on the amount of data that is printed on each page.*

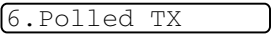
Setting up Polled Transmit (Not available for color faxes)

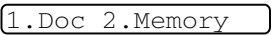
Polled Transmit is when you set up your machine to wait with a paper original so another fax machine can call and retrieve it.

- 1** If it is not illuminated in green, press  **(Fax)**.
 - 2** Load your original. (See *Load originals* on page 2-1.)
 - 3** Press **Menu/Set, 2, 2, 6**.

 - 4** Press  or  to choose On (or Off).
Press **Menu/Set**.

 - 5** Press **1** to leave the original waiting in the ADF.
—OR—
Press **2** to scan the original into memory.
 - 6** Press **1** if you want to choose more settings and the LCD will return to the *Setup Send* menu.
—OR—
Press **2** if you have finished choosing settings, and go to Step 7.
 - 7** Press **Black Start**.
The machine starts scanning the document.
 - 8** If you place the original in the ADF, wait for the fax to be polled.
-  If you press **1** in Step **5**, the original remains in the ADF until your machine is polled. If you must use your machine before the polled transmit occurs, you must first cancel this job.
-  If you press **2** in Step **5**, the document will be stored and can be retrieved from any other fax machine until you delete the fax from the memory by canceling the scheduled job. (See *Canceling a scheduled job* on page 6-12.)

Delayed Batch Transmission (Not available for color faxes)

Before sending the delayed faxes, your machine will help you economize by sorting all the faxes in the memory by destination and scheduled time. All delayed faxes that are scheduled to be sent at the same time to the same fax number will be sent as one fax to save transmission time.

1 If it is not illuminated in green, press  (**Fax**).

2 Load your original. (See *Load originals* on page 2-1.)

3 Press **Menu/Set, 2, 2, 4**.

4.Batch TX

4 Press  or  to select On (or Off).

Press **Menu/Set**.

5 Press **Stop/Exit**.

7

Quick-Dial numbers and dialing options

Storing numbers for easy dialing

You can set up your machine to do three types of easy dialing: One-Touch, Speed-Dial and Groups for Broadcasting faxes.



If you lose electrical power, the quick-dial numbers that are in the memory will not be lost.

Storing One-Touch Dial numbers

Your machine has 5 One-Touch keys where you can store 10 fax or phone numbers for automatic dialing. To access numbers 6 to 10, hold down **Shift** as you press the One-Touch key. When you press a One-Touch key the LCD shows the name, if you stored it, or the number.

One-Touch keys are the 5 keys (numbers 01–10) located on the left side of the control panel.

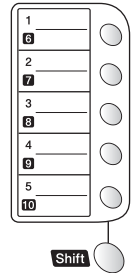

- 1 Press **Menu/Set**, **2**, **3**, **1**.
- 2 Press the One-Touch key where you want to store a number.
- 3 Enter a number (up to 20 digits).
Press **Menu/Set**.

1.One-Touch Dial

- If you want to enter a pause in the dialing sequence (for example, to access an outside line), press **Redial/Pause** as you are entering the digits.
Each key press of **Redial/Pause** enters a 3.5 second pause when the number is dialed, and a dash appears on the screen.

4 Use the dial pad to enter the name (up to 15 characters).
Press **Menu/Set**.
(You can use the chart on page 4-3 to help you enter letters.)

—OR—

Press **Menu/Set** to store the number without a name.

5 Go to Step 2 to store another One-Touch number.

—OR—

Press **Stop/Exit**.

When you dial a quick-dial number, the LCD shows the name you've stored, or, if you haven't stored a name only, the number you've stored.

Storing Speed-Dial numbers

You can store Speed-Dial numbers, so that when you dial you will only have to press a few keys (**Search/Speed Dial**, #, the two-digit number, and **Black Start** or **Color Start**). The machine can store 40 Speed-Dial numbers.

1 Press **Menu/Set**, **2**, **3**, **2**.

2.Speed-Dial

2 Use the dial pad to enter a two-digit Speed-Dial location number (01-40).

(For example, press **05**.)

Press **Menu/Set**.

3 Enter the phone or fax number (up to 20 digits).

Press **Menu/Set**.

4 Use the dial pad to enter the name (up to 15 characters).

Press **Menu/Set**.

(You can use the chart on page 4-3 to help you enter letters.)

—OR—

Press **Menu/Set** to store the number without a name.

5 Go to Step 2 to store another Speed-Dial number.

—OR—

Press **Stop/Exit**.

Changing One-Touch and Speed-Dial numbers

If you try to store a One-Touch or Speed-Dial number where a number has already been stored, the LCD will show the name that has been stored there (or number) and will ask you to do one of the following:



- 1 Press **1** to change the stored number.

1.Change 2.Exit

—OR—

Press **2** to exit without making a change.

How to change the stored number:

- If you want to erase the whole number or whole name, press **Stop/Exit** when the cursor is under the first the digits or letters. The characters above and to the right of the cursor will be deleted.
- If you want to change a character, use  or  to position the cursor under the character you want to change, and then type over it.

- 2 Enter a new number.

Press **Menu/Set**.

- 3 Follow the directions beginning at Step 4 in Storing One-Touch Dial numbers and Storing Speed-Dial numbers. (See *Storing One-Touch Dial numbers* on page 7-1 and *Storing Speed-Dial numbers* on page 7-3.)

Setting up Groups for Broadcasting

Groups, which can be stored on a One-Touch key or a Speed-Dial location, allow you to send the same fax message to many fax numbers by pressing only a One-Touch key and **Black Start** or **Search/Speed Dial**, #, the two-digit location and **Black Start**.

First, you'll need to store each fax number as a One-Touch or Speed-Dial number. Then, you can combine them into a Group, *Each Group uses up a One-Touch key or a Speed-Dial location*. Finally, you can have up to six small Groups, or you can assign up to 49 numbers to one large Group.

(See *Storing Speed-Dial numbers* on page 7-3 and *Changing One-Touch and Speed-Dial numbers* on page 7-4.)

1 Press **Menu/Set**, **2**, **3**, **3**.

3.Setup Groups

2 Decide where you wish to store the Group.

—**AND**—

Press a One-Touch key.

—**OR**—

Press **Search/Speed Dial** and enter the two-digit location, and then press **Menu/Set**.

3 Use the dial pad to enter the Group number.

Setup Group:G0

Press **Menu/Set**.

(For example, press **1** for Group 1.)

- 4 To include One-Touch or Speed-Dial numbers in the Group, enter them as if you were dialing.
For example, for One-Touch key **05**, press One-Touch key **05**. For Speed-Dial location 09, press **Search/Speed Dial**, then press **09** on the dial pad. The LCD shows *05, #09.
- 5 Press **Menu/Set** to accept the numbers for this Group.
- 6 Use the dial pad and the chart on page 4-3 to enter a name for the Group.
Press **Menu/Set**.
(For example, NEW CLIENTS)
- 7 Press **Stop/Exit**.



You can print a list of all One-Touch and Speed-Dial numbers. (See *Printing reports (FAX-1820C only)* on page 9-3 or *Printing reports (MFC-3220C only)* on page 9-4.) Group numbers will be marked in the GROUP column.

Dialing options

Access codes and credit card numbers

Sometimes you may want to choose from several long distance carriers when you make a call. Rates may vary depending on the time and destination. To take advantage of low rates, you can store the access codes or long-distance carriers and credit card numbers as One-Touch and Speed-Dial numbers. You can store these long dialing sequences by dividing them and setting them up on separate keys in any combination. You can even include manual dialing using the dial pad.

The combined number will be dialed in the order that you entered it as soon as you press **Black Start** or **Color Start**.

(See *Storing One-Touch Dial numbers* on page 7-1.)

For example, you can store '555' on One-Touch key 03 and '7000' on One-Touch key 02. If you press One-Touch key **03**, One-Touch key **02**, and **Black Start** or **Color Start**, you will dial '555-7000'.

To temporarily change a number, you can substitute part of the number with manual dialing using the dial pad.

For example, to change the number to 555-7001 you could press One-Touch key **03** and then press **7001** using the dialing pad.



If you must wait for another dial tone or signal at any point in the dialing sequence, store a pause there in the number by pressing **Redial/Pause**. Each key press adds a 3.5-second delay.

Pause

Press **Redial/Pause** to insert a 3.5-second pause between numbers. If you are dialing overseas, you can press **Redial/Pause** as many times as needed to increase the length of the pause.

Fax Redial

If you're sending a fax manually and the line is busy, press **Redial/Pause** to try again. Any time you want to make a second call to the last number dialed, press **Redial/Pause** to save time.

If you're sending a fax automatically and the line is busy, the machine will automatically redial one time five minutes after the transmission.

Tone or Pulse

If you have a Pulse dialing service, but need to send Tone signals (for example, for telephone banking), follow the instructions below. If you have Touch Tone service, you will not need this feature to send tone signals.

1 If you have the FAX-1820C, lift the handset.

—OR—

If you have the MFC-3220C, lift the handset of the external phone.

2 Press #. Any digits dialed after this will send tone signals.

3 When you hang up, the machine will return to the Pulse dialing service.

Telephone (voice) operation (FAX-1820C only)

You can use the machine to make voice telephone calls by dialing manually or by using Search, One-Touch Dial or Speed-Dial memory. You can use the handset to make and receive calls.

When you dial an quick-dial number, the LCD shows the name you've stored, or if you haven't stored a name, the fax number you've stored.

How to dial



There are four ways to dial. (See *How to dial* on page 6-1.)

Making a telephone call

1 Pick up the handset.

—OR—

Press **Hook**.

2 When you hear a dial tone, dial the call using the dial pad, One-Touch, Speed-Dial and Search. (See *How to dial* on page 6-1.)



If you pressed **Hook** to dial, pick up the handset when the other person answers. (The speaker works only one way. The other person won't be able to hear you unless you pick up the handset.)

3 To hang up, replace the handset.

Hold

1 Press **Hold** or **Hook/Hold** to put a call on Hold.

2 You can put down the handset without disconnecting the call.

3 Pick up the machine's handset to release the call from Hold. Picking up an extension handset will not release the call from Hold.

8

Remote Fax Options

Fax Forwarding/Paging





You cannot use Paging and Fax Forwarding at the same time. After you have selected the Paging or Fax Forwarding feature, Fax Storage is set to On automatically. If you bring the Paging or Fax Forwarding feature back to Off, Fax Storage stays on.

Programming a Fax Forwarding number

When Fax Forwarding is set to On, your machine stores the received fax in the memory. Then it dials the fax number you've programmed and forwards the fax message.

1 Press **Menu/Set**, **2**, **5**, **1**.

1.Fax Fwd/Paging

2 Press  or  to select Fax Forward.

Press **Menu/Set**.

The LCD will ask you to enter the fax number to which faxes will be forwarded.

Fwd#:

3 Enter the forwarding number (up to 20 digits).

Press **Menu/Set**.



4 Press **Stop/Exit**.

Programming your pager number

When Paging is selected, your machine dials the pager number you've programmed, and then dials your Personal Identification Number (PIN). This activates your pager so you will know that you have a fax message in the memory.

1 Press **Menu/Set, 2, 5, 1.**

1.Fax Fwd/Paging

2 Press  or  to select
Paging.

Press **Menu/Set.**

3 Enter your pager phone number followed by # # (up to 20 digits).
Press **Menu/Set.**

Do not include the area code if it is the same as that of your machine.

For example, press **1 8 0 0 5 5 5 1 2 1 2 # #.**

4 If your pager needs a PIN, enter the PIN, press #, press **Redial/Pause**, enter your fax number followed by # #.
Press **Menu/Set.**

(For example, press **1 2 3 4 5 # Redial/Pause 1 8 0 0 5 5 5 1 2 1 2 # #**)

—OR—

If you do not need a PIN, press **Redial/Pause**, enter your fax number followed by # #.

Press **Menu/Set.**

(For example, press **Redial/Pause 1 8 0 0 5 5 5 1 2 1 2 # #**)

5 Press **Stop/Exit.**



You cannot change a Paging number or PIN remotely.

Setting Fax Storage

If you set Fax Storage to ON, you will be able to retrieve fax messages from another location using Fax Forwarding, Paging, or Remote Retrieval operations. (See *Remote commands* on page 8-6.) If there is paper in your machine, a back-up copy of each fax will be printed. The LCD will show when you have a fax stored in memory.

1 Press **Menu/Set, 2, 5, 2**.

The LCD will ask you to choose a fax setting.

2.Fax Storage

2 Press  or  to select On (or Off).

Press **Menu/Set**.

3 Press **Stop/Exit**.



If there are faxes in the memory when you turn Fax Storage OFF, the LCD will ask if you want to erase the faxes in the memory.

Erase All Fax?

1.Yes 2.No

If you press **1**, all fax data is erased and Fax Storage is turned off.

If you press **2**, faxes are not erased and Fax Storage stays on.

(See *Printing a fax from the memory* on page 5-6.)



After you have selected the Paging or Fax Forwarding feature, Fax Storage is set to On automatically. If you turn the Paging or Fax Forwarding feature back to Off, Fax Storage stays on.

Backup Print

If you've set Fax Storage to On, your machine automatically prints faxes as they are received into the memory.

This is a safety feature in case the power goes off so you won't lose your messages.

Setting your Remote Access Code

The remote access code lets you access the Remote Retrieval features when you are away from your machine. Before you use the remote access and retrieval features, you have to set up your own code. The default code is inactive code (--- *).

1 Press **Menu/Set, 2, 5, 3**.

3.Remote Access

2 Enter a three-digit code using numbers **0-9, *** or **#**.

Press **Menu/Set**. (The preset ‘*’ cannot be changed.)

 Do not use the same digits that appear in your Fax Receive Code (* **51**) or Telephone Answer Code (**#51**).
(See *Operation from extension telephones* on page 5-7.)

3 Press **Stop/Exit**.

 You can change your code at any time by entering a new one. If you want to make your code inactive, press **Stop/Exit** in Step 2 to restore the inactive setting (--- *).

Remote Retrieval

You can call your machine from any touch tone telephone or fax machine, then use the Remote Access Code and remote commands to retrieve fax messages. Be sure to cut out the Remote Retrieval Access Card on the last page and keep it with you at all times.

Using your Remote Access Code

- 1** Dial your fax number from a telephone or another fax machine using touch tone.
- 2** When your machine answers, immediately enter your Remote Access Code (3 digits followed by *).
- 3** The machine signals if it has received fax messages:
1 long beep — Fax messages
No beeps — No messages
- 4** The machine gives two short beeps, which tells you to enter a command. The machine will hang up if you wait longer than 30 seconds to enter a command. The machine will beep three times, if you enter an invalid command.
- 5** Press **90** to reset the machine when you've finished.
- 6** Hang up.

 If your machine is set to `Manual` mode and you want to use the remote retrieval features, you can access your machine by waiting about 2 minutes after it starts ringing, and then entering the Remote Access Code within 30 seconds.

Remote commands

Follow the commands below to access features when you are away from the machine. When you call the machine and enter your Remote Access Code (3 digits followed by *), the system will give two short beeps and you must enter a remote command.

Remote commands	Operation details
95 Change the Fax Forwarding or Paging settings	
1 OFF	If you hear one long beep, the change has been accepted. If you hear three short beeps, you cannot change it because the conditions have not been met (for example, registering a fax forwarding or paging number). You can register your Fax Forwarding number by entering 4. (See <i>Changing your Fax Forwarding number</i> on page 8-7). Once you have registered the number, Fax Forwarding will be set to On.
2 Fax Forwarding	
3 Paging	
4 Fax Forwarding number	
6 Fax Storage ON	You can turn Fax Storage to On (or Off after you have retrieved or erased all your messages).
7 Fax Storage OFF	
96 Retrieve a fax	
2 Retrieve all faxes	Enter the number of a remote fax machine to receive stored fax message(s). (See page 8-7.)
3 Erase faxes from the memory	If you hear one long beep, you can erase fax messages from the memory.
97 Check the receiving status	
1 Fax	You can check whether your machine has received any faxes. If yes, you will hear one long beep. If no, you will hear three short beeps.
98 Change the Receive Mode	
1 External TAD	If you hear one long beep, you can change the Receive Mode.
2 Fax/Tel	
3 Fax Only	
90 Exit	After a long beep, you can exit Remote Retrieval.

Retrieving fax messages

- 1 Dial your fax number.
 - 2 When your machine answers, immediately enter your Remote Access Code (3 digits followed by *). If you hear one long beep, you have messages.
 - 3 As soon as you hear two short beeps, use the dial pad to press **962**.
 - 4 Wait for the long beep, and then use the dial pad to enter the number of the remote fax machine where you want your fax messages sent to followed by ## (up to 20 digits).
-  You cannot use * and # as dial numbers. However, press # if you want to store a pause.
- 5 Hang up after you hear your machine beep. Your machine will call the other machine, which will then print your fax messages.

Changing your Fax Forwarding number

You can change the default setting of your fax forwarding number from another telephone or fax machine using Touch Tone.

- 1 Dial your fax number.
 - 2 When your machine answers, immediately enter your Remote Access Code (3 digits followed by *). If you hear one long beep, you have messages.
 - 3 When you hear two short beeps, use the dial pad to press **954**.
 - 4 Wait for the long beep, and then use the dial pad to enter the new number of the remote fax machine where you want your fax messages forwarded followed by ## (up to 20 digits).
-  You cannot use * and # as dial numbers. However, press # if you want to store a pause.
- 5 Hang up after you hear your machine beep.

9 Printing reports

Machine settings and activity

You need to set up the Transmission Verification Report and Journal Period in the menu table.

Press **Menu/Set, 2, 4, 1.**

1.Transmission

—OR—

Press **Menu/Set, 2, 4, 2.**

2.Journal Period

Customizing the Transmission Verification Report

You can use the Transmission Report as proof that you sent a fax. This report lists the time and date of transmission and whether the transmission was successful (OK). If you select **On** or **On+Image**, the report will print for every fax you send.

If you send a lot of faxes to the same place, you may need more than the job numbers to know which faxes you must send again. Selecting **On+Image** or **Off+Image** will print a section of the fax's first page on the report to help you remember.



When the Verification Report is turned **OFF**, the Report will only print if there is a transmission error, and in the **RESULT** column it will show **NG**.

1 Press **Menu/Set, 2, 4, 1.**

1.Transmission

2 Press  or  to select **Off**, **Off+Image**, **On** or **On+Image**.

Press **Menu/Set.**

3 Press **Stop/Exit.**



Setting the Journal Period

You can set the machine to print a journal at specific intervals (every 50 faxes, 6, 12 or 24 hours, 2 or 7 days). If you set the interval to *Off*, you can print the report by following the Steps on the next page.

The default setting is *Every 50 Faxes*.

1 Press **Menu/Set, 2, 4, 2.**

2.Journal Period

2 Press  or  to choose an interval.

Press **Menu/Set.**

(If you choose 7 days, the LCD will ask you to choose a day on which to begin the 7-day countdown.)

3 Enter the time to begin printing in 24-hour format.

Press **Menu/Set.**

(For example: enter 19:45 for 7:45 PM.)

4 Press **Stop/Exit.**



If you select 6, 12, 24 hours, 2 or 7 days, the machine will print the report at the selected time and then erase all jobs from its memory. If the machine's memory becomes full with 200 jobs before the time you selected has passed, the machine will print the Journal early and then erase all jobs from memory. If you want an extra report before it is due to print, you can print it without erasing the jobs from memory.





If you select *Every 50 Faxes*, the machine will print the Journal when the machine has stored 50 jobs.

Printing reports (FAX-1820C only)

Five reports are available:

- | | |
|-----------------|---|
| 1.Help List | Prints the Help List so you can see at-a-glance how to quickly program your machine. |
| 2.Quick-Dial | Lists names and numbers stored in the One-Touch and Speed-Dial memory, in numerical order. |
| 3.Fax Journal | Lists information about the last incoming and outgoing faxes.
(TX means Transmit.) (RX means Receive.) |
| 4.Transmission | Prints a Transmission Verification Report for your last transmission. |
| 5.User Settings | Lists your settings. |

To print a report

- 1 Press **Ink/Reports** key with **Shift** key.
- 2 Press  or  to select the report you want.
Press **Menu/Set**.
—OR—
Enter the number of the report you want to print.
For example, press **1** to print the Help List.
- 3 Press **Black Start**.



Printing reports (MFC-3220C only)

Five reports are available:

- | | |
|------------------|---|
| 1. Help List | Prints the Help List so you can see at-a-glance how to quickly program your machine. |
| 2. Quick-Dial | Lists names and numbers stored in the One-Touch and Speed-Dial memory, in numerical order. |
| 3. Fax Journal | Lists information about the last incoming and outgoing faxes.
(TX means Transmit.) (RX means Receive.) |
| 4. Transmission | Prints a Transmission Verification Report for your last transmission. |
| 5. User Settings | Lists your settings. |

To print a report

1 Press **Menu/Set**, **5**.

2 Press  or  to select the report you want.

Press **Menu/Set**.

—OR—

Enter the number of the report you want to print.

For example, press **1** to print the Help List.



3 Press **Black Start**.

10 Making copies

Using the machine as a copier

You can use your machine as a copier, making up to 99 copies at a time.

Enter Copy mode

Before making copies, make sure that  (**Copy**) is illuminated in green. If it is not, press  (**Copy**) to enter **Copy** mode. The default setting is Fax. You can change the number of seconds or minutes that the machine stays in Copy mode. (See *Setting the Mode Timer (MFC-3220C only)* on page 4-5 or *Setting the Mode Timer (FAX-1820C only)* on page 4-5.)

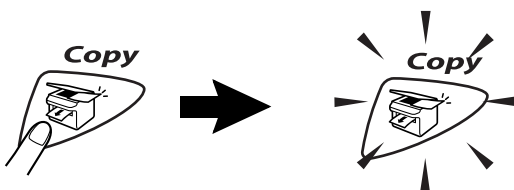

The LCD shows the default copy setting

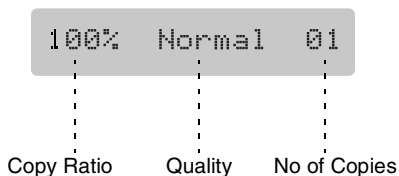

Making a single copy

- 1 Press  (**Copy**) to illuminate it in green.
- 2 Load your original. (See *Load originals* on page 2-1.)
- 3 Press **Black Start** or **Color Start**.

 To stop copying, press **Stop/Exit**.

Making multiple copies

- 1 Press  (**Copy**) to illuminate it in green.
- 2 Load your original. (See *Load originals* on page 2-1.)
- 3 Use the dial pad to enter the number of copies you want (up to 99).
- 4 Press **Black Start** or **Color Start**.

 To sort the copies, press the **Options** key. (See *Using the Copy keys (Temporary settings)* on page 10-3.)

Out of Memory message

If the memory becomes full while you are making copies, the LCD message will guide you through the next step.

Out of Memory

If the `Out of Memory` message appears, press **Stop/Exit** to cancel or **Black Start** or **Color Start** to copy scanned pages. You will need to clear some jobs from the memory before you can continue.

 To gain extra memory, you can turn off Fax Storage. (See *Setting Fax Storage* on page 8-3.)

—OR—

Print the faxes that are in the memory. (See *Printing a fax from the memory* on page 5-6.)

When you get an `Out of Memory` message, you may be able to make copies if you first print incoming faxes in the memory to restore the memory to 100%.

Using the Copy keys (Temporary settings)

When you want to change the settings only for the next copy, use the Temporary Copy keys. You can use different combinations.



These settings are temporary, and the machine returns to its default settings 60 seconds after it finishes copying. If you want to use these temporary settings again, place the next original in the ADF within that time. However, if you have set the Mode Timer for copy and Scan (Only for MFC Models) modes to 0 or 30 seconds, the machine returns to the default settings after the number of seconds that has been set for mode timer. (See *Setting the Mode Timer (MFC-3220C only)* on page 4-5.)

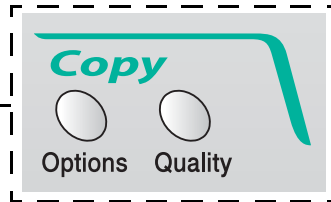

Temporary Copy keys



Quality





You can select the copy quality. The default setting is *Normal*.

<p>Press Quality</p>  <p>and  or </p>	Normal	Recommended mode for ordinary printouts. Good copy quality with adequate copy speed.
	Fast	Fast copy speed and lowest ink consumption. Use FAST to save time (original to be proof-read, large originals or many copies).
	Best	Use this mode to copy precise images such as photographs. BEST uses the highest resolution and slowest speed.

- 1 Press  (**Copy**) to illuminate it in green.
- 2 Load your original. (See *Load originals* on page 2-1.)
- 3 Use the dial pad to enter the number of copies you want (up to 99).
- 4 Press **Quality**.
- 5 Press  or  to choose the copy quality (*Fast*, *Normal* or *Best*). Press **Menu/Set**.
- 6 Press **Black Start** or **Color Start**.
—OR—
Press other Temporary Copy keys for more settings.

Options



Use the **Options** key to set the following copy settings only for the next copy.

Press Copy Options	Menu Selections  +  select Menu/Set	Options  +  select Menu/Set	Factory Setting	Page
 Options	Enlarge/Reduce	50%/78%:LGL→LTR/ 93% A4→LTR/100%/ 104%:EXE→LTR/ 186%:4"×6"→LTR/ 200%/ Custom(25-400%)	100%	10-6
	Paper Type	Plain/Inkjet/ Glossy (4-Color or 3-Color)/ Transparency	Plain	10-7
	Paper Size	Letter/Legal/ 4" (W)×6" (H)	Letter	10-8
	Brightness	- ■■■■ +	- ■■■■ +	10-8
	Contrast	- ■■■■ +	- ■■■■ +	10-9
	Stack/Sort	Stack/Sort	Stack	10-9
	Page Layout	Off(1 in 1)/ 2 in 1/4 in 1(P)/ 4 in 1(L)	Off (1 in 1)	10-10
	No. of Copies	No. of Copies:01 (01-99)	01	

After you finish choosing settings using the **Options** key, the LCD shows *Press Start* and then returns to Menu selections.

Press **Black Start** or **Color Start** if you're finished choosing settings.



—OR—





Press  or  to select more settings.

Enlarge/Reduce

You can select the following enlargement or reduction ratios.

Custom allows you to enter a ratio from 25% to 400%.

Press Options  Options and  or  to select Enlarge/Reduce	100%
	104% : EXE→L/TR
	186% : 4" × 6" →L/TR
	200%
	Custom (25-400%)
	93% : A4→L/TR
	78% : LGL→L/TR
	50%

- 1 Press  (**Copy**) to illuminate it in green.
- 2 Load your original. (See *Load originals* on page 2-1.)
- 3 Use the dial pad to enter the number of copies you want (up to 99).
- 4 Press **Options** and  or  to select Enlarge/Reduce.
Press **Menu/Set**.
- 5 Press  or  to select the enlargement or reduction ratio you want.
Press **Menu/Set**.

—OR—

You can select **Custom** and press **Menu/Set**.

Use the dial pad to enter an enlargement or reduction ratio from 25% to 400%.

Press **Menu/Set**.

(For example, press **5 3** to enter 53%.)

- 6 Press **Black Start** or **Color Start**.







—OR—

Press  or  for more settings.

 Special Copy Options (2in1 or 4in1) are not available with **Enlarge/Reduce**.

Paper Type

You can change the paper type only for the next copy. Select the type of media that you are using to get the best print quality.

- 1 Press  (**Copy**) to illuminate it in green.
- 2 Load your original. (See *Load originals* on page 2-1.)
- 3 Use the dial pad to enter the number of copies you want (up to 99).
- 4 Press **Options** and  or  to select **Paper Type**. Press **Menu/Set**.
- 5 Press  or  to select the type of paper you are using (Plain, Inkjet, Glossy or Transparency). Press **Menu/Set**.
- 6 If you selected **Glossy**, press  or  to select **Glossy: 4-Color** or **Glossy: 3-Color**. Press **Menu/Set**.

 The print quality of black ink depends on the type of glossy paper you are using. Black ink is used when you select **Glossy: 4-Color**. If the glossy paper you are using repels the black ink, select **Glossy: 3-Color**, which simulates black ink by combining the three ink colors.

- 7 Press **Color Start** or **Black Start**.

—OR—

Press  or  for more settings.







 You can change the default Paper Type setting at any time. (See *Setting the Paper Type* on page 4-6.)

Paper Size

You can change the paper size setting only for the next copy.











You can copy only on Letter, Legal, and Photo Card (4"(W)X6"(H)) paper.

- 1 Press  (**Copy**) to illuminate it in green.
- 2 Load your original. (See *Load originals* on page 2-1.)
- 3 Use the dial pad to enter the number of copies you want (up to 99).
- 4 Press **Options** and  or  to select Paper Size. Press **Menu/Set**.
- 5 Press  or  to select the size of paper you are using (Letter, Legal or 4" (W)X6" (H)). Press **Menu/Set**.
- 6 Press **Black Start** or **Color Start**.
—OR—
Press  or  for more settings.









Brightness

You can adjust the copy brightness to make copies darker or lighter.

- 1 Press  (**Copy**) to illuminate it in green.
- 2 Load your original. (See *Load originals* on page 2-1.)
- 3 Use the dial pad to enter the number of copies you want (up to 99).
- 4 Press **Options** and  or  to select Brightness. Press **Menu/Set**.

- 5 Press  to make a lighter copy.
—OR—
Press  to make a darker copy. Press **Menu/Set**.
- 6 Press **Black Start** or **Color Start**.
—OR—
Press  or  for more settings.







Contrast

You can adjust the copy contrast to help an image look sharper and more vivid.

- 1 Press  (**Copy**) to illuminate it in green.
- 2 Load your original. (See *Load originals* on page 2-1.)
- 3 Use the dial pad to enter the number of copies you want (up to 99).
- 4 Press **Options** and  or  to select **Contrast**.
Press **Menu/Set**. 
- 5 Press  to decrease the contrast.
—OR—
Press  to increase the contrast.
Press **Menu/Set**.
- 6 Press **Black Start** or **Color Start**.
—OR—
Press  or  for more settings.





Sorting copies

You can sort multiple copies. Pages will be stacked in the order 123, 123, 123, and so on.

- 1 Press  (**Copy**) to illuminate it in green.
- 2 Load your original. (See *Load originals* on page 2-1.)
- 3 Use the dial pad to enter the number of copies you want (up to 99).
- 4 Press **Options** and  or  to select **Stack/Sort**.
Press **Menu/Set**.
- 5 Press  or  to select **Sort**.
Press **Menu/Set**.
- 6 Press **Black Start** or **Color Start**.
—OR—
Press  or  for more settings.

N in 1 copy (Page Layout)

You can save paper by copying either two or four pages on one page. If you want to print a poster, use the scanner glass. Please make sure paper size is set to `Letter` or `Legal`.

- 1 Press  (**Copy**) to illuminate it in green.
- 2 Load your original. (See *Load originals* on page 2-1.)
- 3 Use the dial pad to enter the number of copies you want (up to 99).
- 4 Press **Options** and  or  to select `Page Layout`. Press **Menu/Set**.
- 5 Press  or  to select `2 in 1`, `4 in 1 (P)`, `4 in 1 (L)`, (or `Off (1 in 1)`). Press **Menu/Set**.
- 6 Press **Black Start** or **Color Start** to scan the original.

 (P) means Portrait and (L) means Landscape.

 For `2 in 1`, `4 in 1 (P)` or `4 in 1 (L)`, you cannot use the `Enlarge/Reduce` setting.

2 in 1

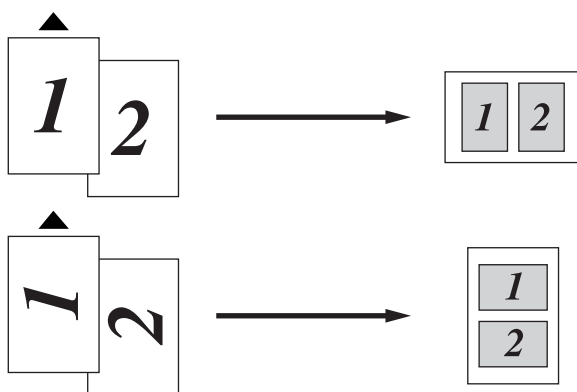

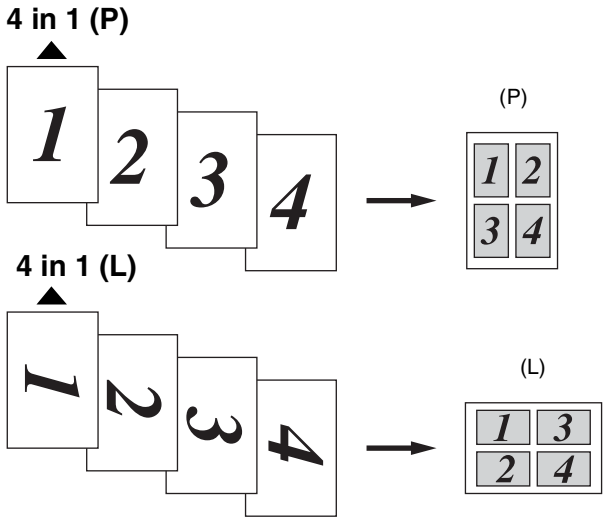

 If 2 in 1 or 4 in 1 copies are in color, you must use letter or A4 paper. For the other Special Copies, you must use letter, legal or A4 paper.



 If you selected *Glossy* in the Paper Type setting, 2 in 1 and 4 in 1 copies are not available.

 2 in 1 or 4 in 1 copies in color are not available with Multiple Copies.

Changing the default copy settings



You can change the default copy settings. These settings will stay until you change them again.

Copy Quality

- 1 Press **Menu/Set**, **3**, **1**.
- 2 Press  or  to select Normal, Best or Fast.
Press **Menu/Set**.
- 3 Press **Stop/Exit**.

1.Quality



Brightness

- 1 Press **Menu/Set**, **3**, **2**.
- 2 Press  to make a lighter copy.
—OR—
Press  to make a darker copy.
Press **Menu/Set**.
- 3 Press **Stop/Exit**.

2.Brightness

Contrast

You can change the contrast to help an image look sharper and more vivid.

- 1 Press **Menu/Set**, **3**, **3**.
- 2 Press  to increase the contrast.
—OR—
Press  to decrease the contrast.
Press **Menu/Set**.
- 3 Press **Stop/Exit**.

3.Contrast

Color Adjustment

1 Press **Menu/Set**, **3**, **4**.

4.Color Adjust

2 Press  or  to select Red, Green or Blue.

Press **Menu/Set**.

3 Press  to increase the color saturation.

—OR—

Press  to decrease the color saturation.

Press **Menu/Set**.

4 Return to Step 2 to select the next color.

—OR—

Press **Stop/Exit**.

Legal limitations

Color reproductions of certain originals are illegal and may result in either criminal or civil liability. This memorandum is intended to be a guide rather than a complete listing of every possible prohibition. In case of doubt, we suggest that you check with counsel as to any particular questionable originals.

The following originals issued by the United States/Canadian Government or any of its Agencies may not be copied:

- Paper money
- Bonds or other certificates of indebtedness
- Certificates of Deposit
- Internal Revenue Stamps (canceled or uncanceled)
- Selective Service or draft papers
- Passports
- United States/Canadian Postage Stamps (canceled or uncanceled)
- Food Stamps
- Immigration Papers
- Checks or drafts drawn by Governmental agencies
- Identifying badges or insignias

Copyrighted works cannot be copied. Sections of a copyrighted work can be copied for 'fair use.' Multiple copies would indicate improper use.

Works of art should be considered the equivalent of copyrighted works.

Licenses and Certificates of Title to motor vehicles may not be copied under certain state/provincial laws.

11 Important information

Standard telephone and FCC Notices

These notices are in effect on models sold and used in the United States only.

This equipment is hearing-aid compatible.

When programming emergency numbers or making test calls to emergency numbers:

- Remain on the line and briefly explain to the dispatcher the reason for the call before hanging up.
- Perform these activities in the off-peak hours, such as early morning or late evening.

This equipment complies with Part 68 of the FCC rules and the requirements adopted by the ACTA. On the backside of this equipment is a label that contains, among other information, a product identifier in the format US: AAAEQ##TXXXX. If requested, this number must be provided to the telephone company.

You may safely connect this equipment to the telephone line by means of a standard modular jack, USOC RJ11C.

A plug and jack used to connect this equipment to the premises wiring and telephone network must comply with the applicable FCC Part 68 rules and requirements adopted by the ACTA. A compliant telephone cord and modular plug is provided with this product. It is designed to be connected to a compatible modular jack that is also compliant. See installation instructions for details.

The REN is used to determine the number of devices that may be connected to a telephone line. Excessive RENs on a telephone line may result in the devices not ringing in response to an incoming call. In most but not all areas, the sum of RENs should not exceed five (5.0). To be certain of the number of devices that may be connected to a line, as determined by the total RENs, contact the local telephone company. For products approved after July 23, 2001, the REN for this product is part of the product identifier that has the format US:AAAEQ##TXXXX. The digits represented by ## are the REN without a decimal point (e.g., 06 is a REN of 0.6). For earlier products, the REN is separately shown on the label.

If this equipment causes harm to the telephone network, the telephone company will notify you in advance that temporary discontinuance of service may be required. But if advance notice isn't practical, the telephone company will notify the customer as soon as possible. Also, you will be advised of your right to file a complaint with the FCC if you believe it is necessary.

The telephone company may make changes in its facilities, equipment, operations or procedures that could affect the operation of the equipment. If this happens the telephone company will provide advance notice in order for you to make necessary modifications to maintain uninterrupted service.

If trouble is experienced with this equipment, for repair or warranty information, please contact Brother Customer Service. (See *Brother numbers* on page i.) If the equipment is causing harm to the telephone network, the telephone company may request that you disconnect the equipment until the problem is resolved.

Connection to party line service is subject to state tariffs. Contact the state public utility commission, public service commission or corporation commission for information.

If your home has specially wired alarm equipment connected to the telephone line, ensure the installation of this equipment does not disable your alarm equipment. If you have questions about what will disable alarm equipment, call your telephone company or a qualified installer.

If you are not able to solve a problem with your machine, call Brother Customer Service. (See *Brother numbers* on page i.)

WARNING

For protection against the risk of electrical shock, always disconnect all cables from the wall outlet before servicing, modifying or installing the equipment.

This equipment may not be used on coin service lines provided by the telephone company or connected to party lines.

Brother cannot accept any financial or other responsibilities that may be the result of your use of this information, including direct, special or consequential damages. There are no warranties extended or granted by this original.

WARNING

This machine has been certified to comply with FCC standards, which are applied to the USA only. A grounded plug should be plugged into a grounded AC outlet after checking the rating of the local power supply for the machine to operate properly and safely.

Federal Communications Commission (FCC) Declaration of Conformity (USA only)

Responsible Party: Brother International Corporation
100 Somerset Corporate Boulevard
Bridgewater, NJ 08807-0911 USA
TEL: (908) 704-1700

declares, that the products

Product Name: FAX-1820C and MFC-3220C

comply with Part 15 of the FCC Rules. Operation is subject to the following two conditions: (1) This device may not cause harmful interference, and (2) this device must accept any interference received, including interference that may cause undesired operation.

This equipment has been tested and found to comply with the limits for a Class B digital device, pursuant to Part 15 of the FCC Rules. These limits are designed to provide reasonable protection against harmful interference in a residential installation. This equipment generates, uses, and can radiate radio frequency energy and, if not installed and used in accordance with the instructions, may cause harmful interference to radio communications. However, there is no guarantee that interference will not occur in a particular installation. If this equipment does cause harmful interference to radio or television reception, which can be determined by turning the equipment off and on, the user is encouraged to try to correct the interference by one or more of the following measures:

- Reorient or relocate the receiving antenna.
- Increase the separation between the equipment and receiver.
- Connect the equipment into an outlet on a circuit different from that to which the receiver is connected.
- Call the dealer or an experienced radio/TV technician for help.

Important

Changes or modifications not expressly approved by Brother Industries, Ltd. could void the user's authority to operate the equipment.

Industry Canada Compliance Statement (Canada only)

This Class B digital apparatus complies with Canadian ICES-003.
Cet appareil numérique de la classe B est conforme à la norme NMB-003 du Canada.

LAN connection



Caution

Do not connect this product to a LAN connection that is subject to over-voltages.

International ENERGY STAR® Compliance Statement

The purpose of the International ENERGY STAR® Program is to promote the development and popularization of energy-efficient office equipment.

As an ENERGY STAR® Partner, Brother Industries, Ltd. has determined that this product meets the ENERGY STAR® guidelines for energy efficiency.



Important safety instructions

- 1** Read all of these instructions.
- 2** Save them for later reference.
- 3** Follow all warnings and instructions marked on the product.
- 4** Unplug this product from the wall outlet before cleaning. Do not use liquid or aerosol cleaners. Use a damp cloth for cleaning.
- 5** Do not use this product near water.
- 6** Do not place this product on an unstable cart, stand, or table. The product may fall, causing serious damage to the product.
- 7** Slots and openings in the cabinet and the back or bottom are provided for ventilation; to ensure reliable operation of the product and to protect it from overheating, these openings must not be blocked or covered. The openings should never be blocked by placing the product on a bed, sofa, rug, or other similar surface. This product should never be placed near or over a radiator or heater. This product should never be placed in a built-in installation unless proper ventilation is provided.
- 8** This product should be operated from the type of power source indicated on the label. If you are not sure of the type of power available, call your dealer or local power company.
Use only the power cord supplied with this machine.
- 9** This product is equipped with a 3-wire grounded plug, a plug having a third (grounded) pin. This plug will only fit into a grounded power outlet. This is a safety feature. If you are unable to insert the plug into the outlet, call your electrician to replace your obsolete outlet. Do not defeat the purpose of the grounded plug.
- 10** Do not allow anything to rest on the power cord. Do not place this product where people can walk on the cord.
- 11** If an extension cord is used with this product, make sure that the total ampere ratings on the products plugged into the extension cord do not exceed the extension cord ampere rating. Also, make sure that the total of all products plugged into the AC power outlet does not exceed 15 amperes (USA only).

- 12** Do not place anything in front of the machine that will block received faxes. Do not place anything in the path of received faxes.
- 13** Wait until pages have exited the machine before picking them up.
- 14** Never push objects of any kind into this product through cabinet slots, since they may touch dangerous voltage points or short out parts resulting in the risk of fire or electric shock. Never spill liquid of any kind on the product. Do not attempt to service this product yourself because opening or removing covers may expose you to dangerous voltage points and other risks and may void your warranty. Refer all servicing to a Brother Authorized Service Center. For the location of your nearest Brother Authorized Service Center, please call **In USA:** 1-800-284-4357 or **In Canada:** 1-877-BROTHER. (See *Brother numbers* on page i.)
- 15** Unplug this product from the AC power outlet and refer servicing to Authorized Service Personnel under the following conditions:
- When the power cord is damaged or frayed.
 - If liquid has been spilled into the product.
 - If the product has been exposed to rain or water.
 - If the product does not operate normally when the operating instructions are followed. Adjust only those controls that are covered by the operating instructions. Improper adjustment of other controls may result in damage and will often require extensive work by a qualified technician to restore the product to normal operation.
 - If the product has been dropped or the cabinet has been damaged.
 - If the product exhibits a distinct change in performance, indicating a need for service.
- 16** To protect your product against power surges, we recommend the use of a power protection device (Surge Protector).

Trademarks

The Brother logo is a registered trademark of Brother Industries, Ltd.

Brother is a registered trademark of Brother Industries, Ltd.

Multi-Function Link is a registered trademark of Brother International Corporation.

© Copyright 2003 Brother Industries, Ltd. All rights reserved.

Windows and Microsoft are registered trademarks of Microsoft in the U.S. and other countries.

Macintosh is a registered trademark of Apple Computer, Inc.

PaperPort and TextBridge are registered trademarks of ScanSoft, Inc.

Presto! PageManager is a registered trademark of NewSoft Technology Corporation.

Each company whose software title is mentioned in this manual has a Software License Agreement specific to its proprietary programs.

All other brand and product names mentioned in this User's Guide are registered trademarks of their respective companies.

12 Troubleshooting and routine maintenance

Troubleshooting

IMPORTANT

For technical help, you must call the country where you bought the machine. Calls must be made **from within** that country.

Error messages

As with any sophisticated office product, errors may occur. If this happens, your machine identifies the problem and displays an error message. The most common error messages are shown below.

You can correct most problems by yourself. If you need additional help, call the Brother fax back system (USA only).

In USA only: 1-800-521-2846

ERROR MESSAGES		
ERROR MESSAGE	CAUSE	ACTION
Check Cartridge	An ink cartridge is not properly installed.	Take out the ink cartridge and put it in again seating it properly. (See <i>Replacing the ink cartridges</i> on page 12-20.)
Check Original	The original was longer than 35.4 inches.	See <i>Using the automatic document feeder (ADF)</i> on page 2-1.
Check Paper Size	Paper is not the correct size.	Reload the correct size of paper (Letter or Legal), and then press Black Start or Color Start .
Check Paper	The machine is out of paper.	Add paper, and then press Black Start or Color Start .
	The paper is jammed in the machine.	See <i>Printer jam or paper jam</i> on page 12-5.
Comm. Error	Poor phone line quality caused a communication error.	Try the call again. If the problem continues, call the telephone company and ask them to check your phone line.
Connection Fail	You tried to poll a fax machine that is not in Polled Waiting mode.	Check the other fax machine's polling setup.
Cover Open	Control panel cover or top cover is not closed completely.	Open, then close the covers.
Disconnected	The other person or other person's fax machine stopped the call.	Try to send or receive again.

ERROR MESSAGES		
ERROR MESSAGE	CAUSE	ACTION
Data Remains	Print data remains in the machine's memory.	Re-start printing from your computer.
	Print data remains in the machine's memory. The USB cable was unplugged while the computer was sending the data to the machine.	Press Stop/Exit . The machine will cancel the job and eject the page that is being printed.
DR Mode in Use	The machine is set to Distinctive Ring mode. You can not change the Receive Mode from Manual to another mode.	Set Distinctive Ring to Off. (See <i>Turning off the Distinctive Ring</i> on page 5-13.)
High Temperature	The print heads are too warm.	Allow the machine to cool down.
Ink Empty	One or more of the ink cartridges is empty. The machine will stop all print operations. While memory is available, black and white faxes will be received into memory. If a sending machine has a color fax, the machine's 'handshake' will request that the fax be sent as black and white. If the sending machine has the ability to convert it, the color fax will be received into memory as a black and white fax.	Replace the ink cartridges. (See <i>Replacing the ink cartridges</i> on page 12-20.)
Instert Original	The original was inserted properly.	See <i>Load originals</i> on page 2-1.
Low Temperature	The print heads are too cold.	Allow the machine to warm up.
Machine Error XX	The machine has a mechanical problem.	Call Brother Customer Service. In USA: 1-800-284-4329 In Canada: 1-877-BROTHER In Montreal: (514) 685-6464
Near Empty	One or more of the ink cartridges are running out of ink. If a sending machine has a color fax, the machine's 'handshake' will request that the fax be sent as black and white. If the sending machine has the ability to convert it, the color fax will be received into memory as a black and white fax.	Order a new ink cartridge. (See <i>Ordering accessories and supplies</i> on page ii.)
No Response/ Busy	The number you dialed does not answer or is busy.	Verify the number and try again.
Not Registered	You tried to access a One-Touch or Speed-Dial number that is not programmed.	Set up the One-Touch or Speed-Dial number. (See <i>Storing One-Touch Dial numbers</i> on page 7-1 and <i>Storing Speed-Dial numbers</i> on page 7-3.)

ERROR MESSAGES

ERROR MESSAGE	CAUSE	ACTION
Out of Memory (May occur when the machine is used as a printer)	You can't store data in the memory.	(Fax sending or copy operation in process) Press Stop/Exit and wait until the other operations in progress finish and then try again. —OR— Clear the data in the memory. (See <i>Out of Memory message</i> on page 10-2.) (Printing operation in process) Reduce print resolution. —OR— Clear the data in the memory. (See <i>Out of Memory message</i> on page 10-2.)
Paper Jam	The paper is jammed in the machine.	(See <i>Printer jam or paper jam</i> on page 12-5.)

Original jam

If the original is jammed, follow the steps below.

Original is jammed inside the front of the control panel.

- 1 Remove any paper from the ADF that is not jammed.
- 2 Pull the jammed original out toward the front of the machine.



- 3 Press **Stop/Exit**.

Original is jammed inside the back of the control panel.

- 1 Remove any paper from the ADF that is not jammed.
- 2 Open the control panel cover.
- 3 Pull the jammed original out toward the back of the machine.

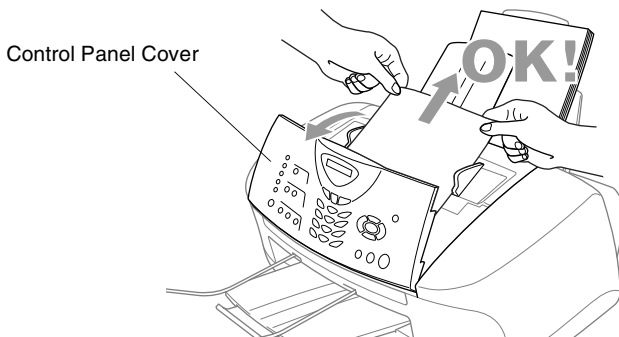

- 4 Close the control panel cover.

Printer jam or paper jam

Remove the jammed paper depending on where it is jammed in the machine.

Paper is jammed inside the front of the machine.

- 1** Pull the paper toward you.

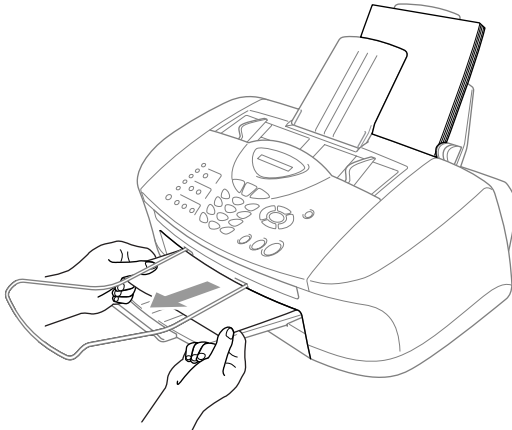

Paper is jammed in the paper tray

- 1** Remove any paper from the paper tray that is not jammed.

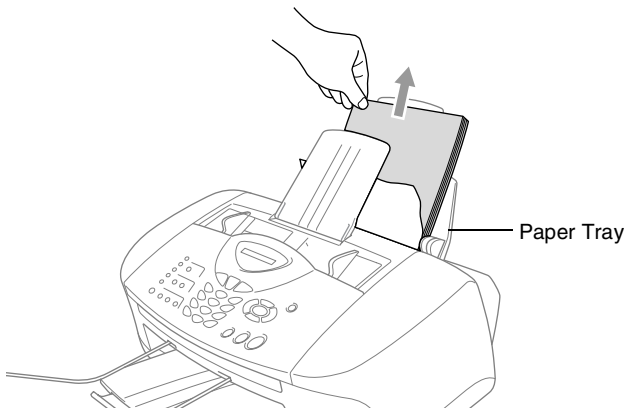

2 Pull up the jammed paper to remove it.

 If it is difficult to pull the jammed paper, try to pull it while holding down the Paper Release Lever.

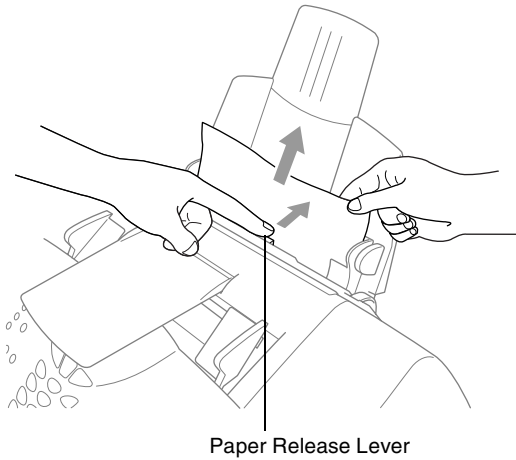

Paper is jammed inside the paper tray

1 Pull the paper tray out of the machine.

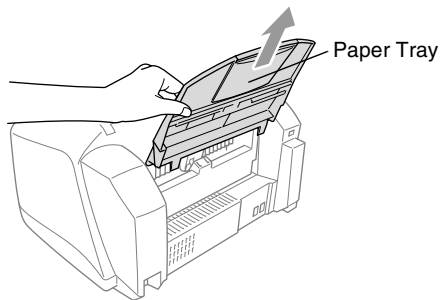

- 2** Pull up the jammed paper to remove it.

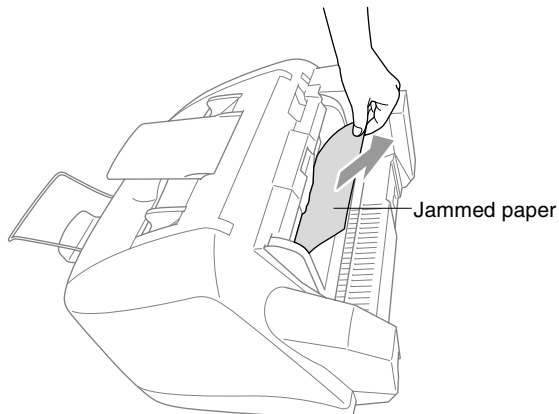

Paper is jammed inside the machine.

- 1** Open the control panel cover by lifting it toward you, and then lift the top cover toward the back.

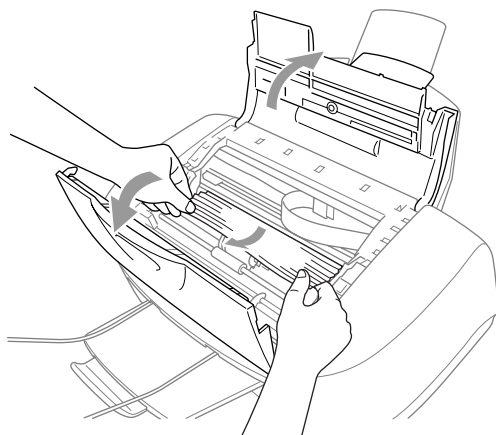

- 2** Remove the jammed paper.

 If the jammed paper is under the Print Head, unplug the machine, and then you can move the Print Head to remove the paper.

- 3** Close top cover and the control panel cover.

If you are having difficulty with your machine

If you think there is a problem with your machine or the way your faxes look, *make a copy first*. If the copy looks good, the problem is probably not your machine. Check the chart below and follow the troubleshooting tips.

DIFFICULTY	SUGGESTIONS
Printing or Receiving Faxes	
Condensed print and white streaks across the page or the top and bottom of sentences are cut off.	This can be caused by static or interference on the telephone line. You can make a copy using the BlackStart key to see if the same problem occurs. If the copy looks bad, call Brother Customer Service at 1-800-284-4329 (in USA), 1-877-BROTHER (in Canada) or (514) 685-6464 (in Montreal).
Poor quality print.	Make sure the Printer Driver or Paper Type setting in the menu matches the type of paper you are using. (See <i>Media Type</i> on page 1-6 in Software User's Guide on the CD-ROM and <i>Setting the Paper Type</i> on page 4-6.) If you are using plain paper, try using the types of recommended paper. (See <i>About paper</i> on page 2-3.) Don't handle the paper until the ink is dry. Adjust the Vertical Alignment. (See <i>Print Quality Check</i> on page 12-11.)
Smudged stain at the top center of the printed page.	Make sure the paper is not too thick or not curled. (See <i>About paper</i> on page 2-3.)
Printing is too dark or too light.	Make sure your ink cartridges are fresh. Cartridges are good for up to two years, after that the ink may become clogged. Cartridge expiration dates are printed on the package. Make sure the Printer Driver matches the type of paper you are using. (See <i>Media Type</i> on page 1-6 in Software User's Guide on the CD-ROM.) Try using the recommended types of paper. (See <i>About paper</i> on page 2-3.) The recommended environment for your machine is between 68°F to 91°F.
Printing appears dirty or ink seems to run.	Make sure you are using the proper types of paper. (See <i>About paper</i> on page 2-3.) Don't handle the paper until the ink is dry. The recommended environment for your machine is between 68°F to 91°F.
White horizontal lines appear in text or graphics.	Clean the print heads. (See <i>Cleaning the print head</i> on page 12-11.)
Stains appear on the reverse side or at the bottom of the page	Make sure the Printer Platen is not dirty with ink. (See <i>Cleaning the machine printer platen</i> on page 12-19.)
Vertical black lines when receiving.	The sender's scanner may be dirty. Ask the sender to make a copy to see if the problem is on with the sending machine. Try receiving from another fax machine. If the problem continues, call Brother Customer Service at 1-800-284-4329 (in USA), 1-877-BROTHER (in Canada) or (514) 685-6464 (in Montreal).
Received color fax prints only in black and white.	Replace the color ink cartridges that are empty or nearly empty, and then ask the other person to send the color fax again. (See <i>Replacing the ink cartridges</i> on page 12-20.) Check that Fax Storage is set to OFF. (See <i>Setting Fax Storage</i> on page 8-3.)
Left and Right margins are cut off.	Turn on Auto Reduction. (See <i>Printing a reduced incoming fax (Auto Reduction)</i> on page 5-6.)

DIFFICULTY	SUGGESTIONS
Phone Line or Connections	
The machine does not answer when called.	Make sure the machine is in the correct receiving mode for your setup. (See <i>Basic receiving operations</i> on page 5-1.) Check for a dial tone. If possible, call your machine to hear it answer. If there is still no answer, check the telephone line cord connection. If there is no ringing when you call your machine, ask your telephone company to check the line.
Sending Faxes	
Poor sending quality.	Try changing your resolution to FINE or S. FINE . Make a copy to check your machine's scanner operation.
Transmission Verification Report says 'Result:NG' or 'Result:ERROR'.	There is probably temporary noise or static on the line. Try sending the fax again. If you send a PC FAX message and get 'Result:NG' or, on the Transmission Verification Report, your machine may be out of memory. To gain extra memory, you can turn off Fax Storage (see <i>Setting Fax Storage</i> on page 8-3), print fax messages in memory (see <i>Printing a fax from the memory</i> on page 5-6) or cancel a Delayed Fax or Polling Job (See <i>Canceling a scheduled job</i> on page 6-12). If the problem continues, ask the telephone company to check your phone line.
Vertical black lines when sending.	If the copy you made shows the same problem, your scanner is dirty. (See <i>Routine maintenance</i> on page 12-18)
Handling Incoming Calls	
machine 'Hears' Voice as CNG Tone.	If your machine is set to Easy Receive ON, it is more sensitive to sounds. Your machine may mistakenly interpret certain voices or music on the line as a calling fax machine and respond with fax receiving tones. Deactivate the fax by pressing Stop/Exit . Try avoiding this problem by turning Easy Receive to OFF. (See <i>Easy Receive (FAX-1820C only)</i> on page 5-5)
Sending a Fax Call to the machine.	If you answered at the machine, press Black Start and hang up immediately. If you answered on an extension phone, press your Fax Receive Code (default setting is (✕)51). When your machine answers, hang up.
Custom features on a single line.	If you have Call Waiting/Caller ID with the MFC-3220C, or Call Waiting, Ring Master, Voice Mail, an alarm system or any other custom feature on a single phone line with your machine, it may create a problem sending or receiving fax data. For example: If you are sending or receiving a fax message while a custom feature signal comes through on the line, the signal can temporarily interrupt or disrupt the fax data. Brother's ECM feature should help overcome this problem. This condition is related to the telephone system industry and is common to all devices that send and receive data on a single, shared line with custom features. If avoiding a slight interruption is crucial to your business, we recommend a separate phone line with no custom features.
Printer Difficulties (MFC-3220C only)	
Horizontal lines appear in text or graphics.	Clean the print head. (See <i>Cleaning the print head</i> on page 12-11.) If you clean the print heads five times and the print has not improved, call Brother Customer Service at 1-800-284-4329 (in USA), 1-877-BROTHER (in Canada) or (514) 685-6464 (in Montreal).
Scanning Difficulties (MFC-3220C only)	
TWAIN errors appear while scanning.	Make sure the Brother TWAIN driver is selected as the primary source. In PaperPort, click Scan in the File menu and select the Brother TWAIN driver.

DIFFICULTY	SUGGESTIONS
Software Difficulties (MFC-3220C only)	
Cannot perform '2 in 1 or 4 in 1' printing.	Check that the paper size setting in the application and in the printer driver are the same.
Cannot print when using Paint Brush.	Try setting the Display setting to '256 colors.'
Cannot print when using Adobe Illustrator.	Try to reduce the print resolution.
Thick lines and thin lines appear alternately. (banding)	<ol style="list-style-type: none"> 1. Open the 'Basic' tab in the printer driver. 2. Click 'Setting' in the Basic tab of the printer driver. 3. Turn OFF 'Bi-Directional Printing' by un-checking it. (See <i>Bi-Directional Printing</i> on page 1-7 in Software User's Guide on the CD-ROM.)
There are some dense lines.	Check 'Reverse Order' in the Basic tab of the printer driver.
Printing is slow.	In the 'Color' tab from the 'Advanced' tab in the printer driver, uncheck the Color Enhancement.
True2Life® is not working properly.	If the image data is not full color in your application (Such as 256 color), True2Life® will not work. Please use at least 24 bit color data with the True2Life® feature.
'MFC is Busy' or 'MFC Connect Failure' Error Message appears.	Make sure the machine is not showing an error message on the LCD.
'MFC Connect Failure'	<p>If the MFC is not connected to your PC and you have loaded the Brother software, the PC will show 'MFC Connect Failure' each time you restart Windows®. You can ignore this message or you can turn it off as follows. Double-click "tool\warnOff.REG" from the supplied CD-ROM.</p> <p>The Scan key on the MFC's control panel will not work unless you restart your PC with the MFC connected.</p> <p>To turn it back on, Double-click "tool\WarnOn.REG" from the supplied CD-ROM.</p>

How to improve print quality

Cleaning the print head

To ensure good print quality, the machine will regularly clean the print head. You can start the cleaning process when needed.

Clean the print head and ink cartridges if you get a horizontal line in the text or graphics on your printed pages. You can clean two colors at a time (Black/Cyan, Yellow/Magenta), or all four colors at once.

Cleaning the print head consumes ink. Cleaning too often uses ink unnecessarily.

WARNING

Do NOT clean the print head by touching it with your hand or a cloth.

1 Press **Ink**.

2 Press  or  to select **Cleaning**.

Press **Menu/Set**.

3 Press  or  to select the color you want to clean.

Press **Menu/Set**.

The machine will clean the print head. When cleaning is finished, the machine will go back standby mode automatically.



If you clean the print head at least five times and the print has not improved, call Brother your dealer for service.

Print Quality Check

If the print quality is not good, you can print a Print Quality Check Sheet to help you find the settings you may need to change.

1 Press **Menu/Set, 4**.

2 Press **Color Start**.

The machine begins printing the Print Quality Check Sheet.

3 Check the sheet to see if the quality and alignment are OK by following STEPs A and B.

STEP A: Color block quality check

The LCD shows:

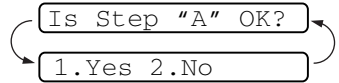

- 4 Check the quality of the four color blocks on the sheet. (Black/Cyan/Yellow/Magenta).
- 5 If all lines are clear and visible, press **1** (Yes) to go to **STEP B**.
—OR—
If you can see missing short lines as shown below, press **2** (No).

OK

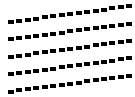

Poor

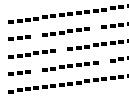

The LCD will ask you if the print quality is OK for each color.

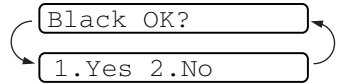

- 6 Press **2** (No) for any color with a problem.

The LCD shows:

Press **1** (Yes). The machine will start cleaning the colors.

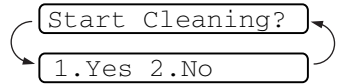

- 7 After cleaning is finished, press **Black Start** or **Color Start**. The machine will start printing the Print Quality Check Sheet again and then return to **STEP A**.
- 8 If **STEP A** is OK, press **1** to proceed to **STEP B**.

STEP B: Alignment Check

The LCD shows:

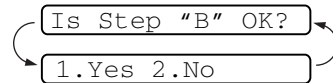

- 9** Check the 600 dpi and 1200 dpi test prints to see if number 5 most closely matches number 0. If the number 5 sample of both the 600 dpi and 1200 dpi are the best matches, press **1** (Yes) to finish **STEP B**.

—OR—

If another test print number is a better match for either 600 dpi or 1200 dpi, press **2** (No) to select it.

- 10** For 600 dpi, press the number of the test print that most closely matches the number 0 sample (1-8).

600dpi Adjust

Select Best #

- 11** For 1200 dpi, press the number of the test print that most closely matches the number 0 sample (1-8).

1200dpi Adjust

Select Best #

- 12** Repeat Steps 1 and 2 (in *Print Quality Check*) to print another sample Print Quality Check Sheet and then check it.

- 13** Press **Stop/Exit**.



When an ink head nozzle is clogged the printed sample looks like this.



After the ink head nozzle is cleaned, the horizontal lines are gone.

If you still see missing ink in this Print Quality Check Sheet, repeat the cleaning and test print procedures at least five times. If ink is still missing after the fifth cleaning and test print, replace the ink cartridge for the clogged color. (Perhaps the ink cartridge was in your machine over six months or the expiration date written on the cartridge package has passed. Or, the ink may not have been stored properly before use.)

After replacing the ink cartridge, check it by printing another Print Quality Check Sheet. If the problem still exists, repeat the cleaning and test print procedures at least five times for the new ink cartridge. If ink is still missing, call Brother Customer Service.



Caution

Do NOT touch the print head. Touching the print heads may cause permanent damage and may void the print head's warranty.

Checking the ink volume



You can check the ink that is left in the cartridge.

1 Press **Ink**.

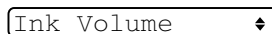
2 Press  or  to select Ink Volume.



Press **Menu/Set**.

3 Press  or  to select the color you want to check.



The LCD shows the ink volume.

4 Press **Stop/Exit**.

Packing and shipping the machine

Whenever you transport the machine, use the packing materials that came with your machine. If you do not pack the machine properly, you could void your warranty.

Caution

Do NOT unplug the machine after a print job until you hear the final click.

- 1 First, remove all the ink cartridges and attach the white shipping cover. (See *Replacing the ink cartridges* on page 12-20.) After attaching the white shipping cover, press all the ink cartridge covers down.

To attach the white shipping cover

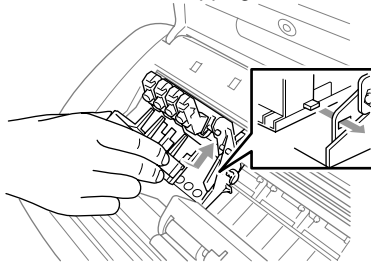

Caution

If you are not able to find the shipping cover, do NOT remove the ink cartridges before shipping. It is essential that the machine be shipped with either the shipping cover or the ink cartridges in position. Shipping without them will cause damage to your machine and may void your warranty.

- 2 Unplug the machine from the telephone wall jack and remove the telephone line cord from machine.
- 3 Unplug the machine from the AC outlet.
- 4 Unplug the USB cable from the machine, if it is connected.

- 5** Attach the yellow protective bar.

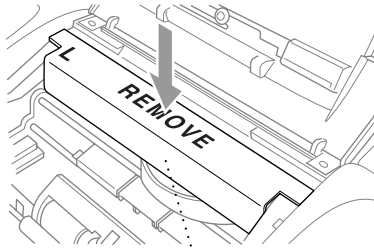

Protective Yellow Bar

- 6** Remove the paper tray and output paper support, ADF Document Output support and ADF Document support. If your machine is a fax model, remove the handset and handset curled cord.

 If you are packing the machine for the Brother Exchange Service, keep these items and return only the machine.

- 7** Wrap the machine in the bag and place it in the original carton with the original packing material.

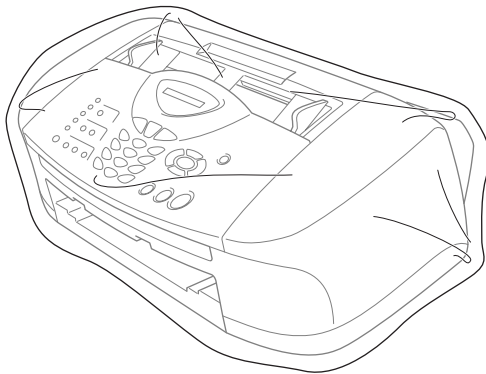

- 8** Pack the printed materials in the original carton as shown below. Do not pack the used ink cartridges in the carton.

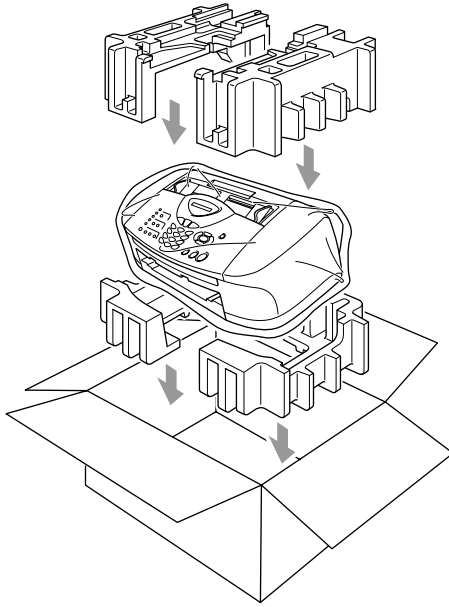

If you are returning your machine to Brother as part of the Exchange Service, pack *only* the machine. Keep all separate parts and printed materials to use with your “Exchange” machine.

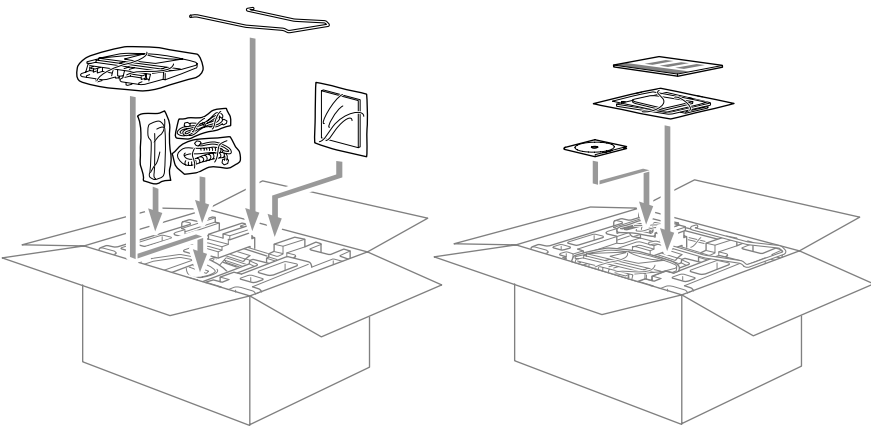

- 9** Close the carton.

Routine maintenance

Cleaning the scanner

Unplug the machine, and then open the control panel cover. Clean the flat white pressure bar and the glass strip below the bar with isopropyl alcohol on a lint-free cloth.

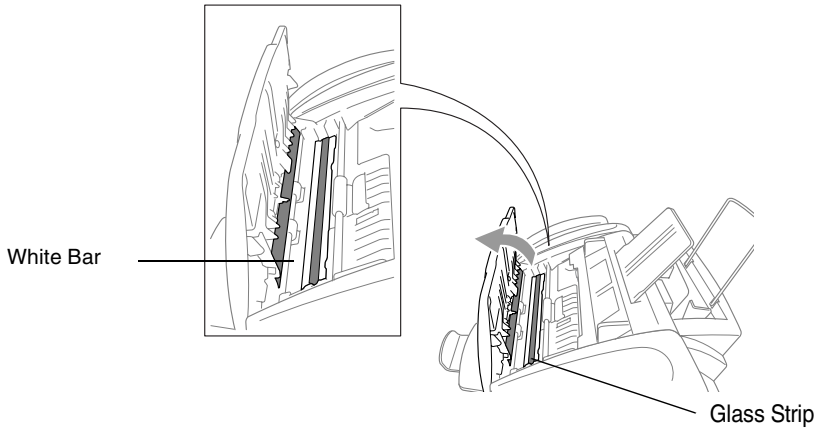

Cleaning the machine printer platen

⚠ WARNING

- Be sure to unplug the machine from the AC power outlet before cleaning the printer platen.
- Be careful not to touch the paper feed star wheels, flat cable and encode film.
- When you want to clean your machine printer platen, wipe it with a lint free cloth that is *dry*.

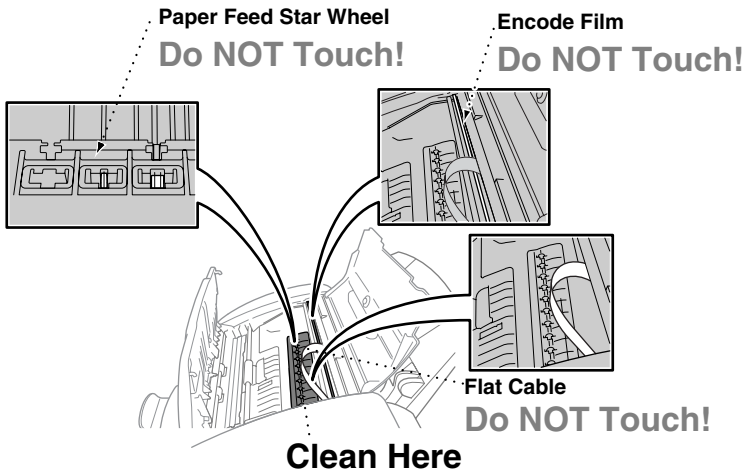



Replacing the ink cartridges

Your machine is equipped with an ink dot counter that automatically monitors the ink level in each color cartridge. When the counter detects an ink cartridge is running out of ink, the machine will notify you with a message on the LCD.

The LCD shows you which color cartridges are low or empty. Be sure to follow the LCD prompts so you replace the color cartridges in the appropriate order.

When the ink cartridges are running low, you must use the Ink key to begin the cartridge replacement (Steps 1 to 3). If the ink is empty, skip to Step 3.

1 Press **Ink**.

2 Press  or  to select **Replace Ink**.

Press **Menu/Set**.

If one or more ink cartridges are empty, for example Black, the LCD shows **Pls Open Cover**.

3 Open the control panel cover, and then lift the top cover.

4 Push the appropriate colored ink cartridge covers and remove the used ink cartridge.

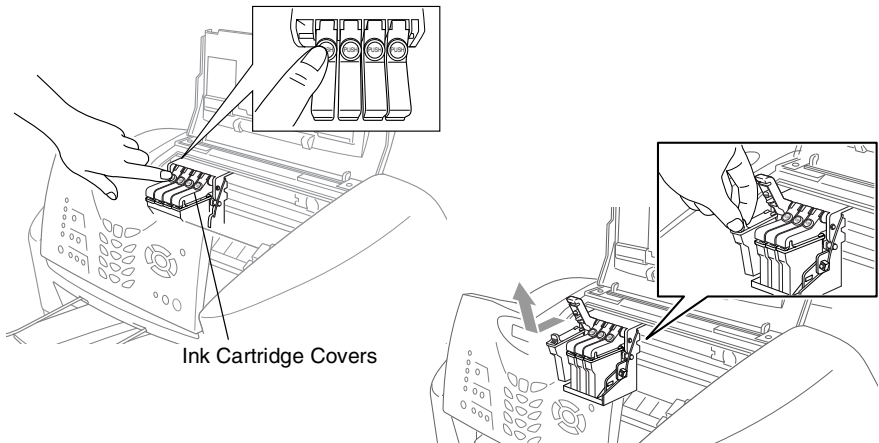

5 Open the new ink cartridge bag for the color shown on the LCD, and then take out the ink cartridge.

- 6** Hold the new ink cartridge as shown in the illustration, and then peel the sealing tape from the side of the ink cartridge. Carefully peel the tape in the direction away from you.

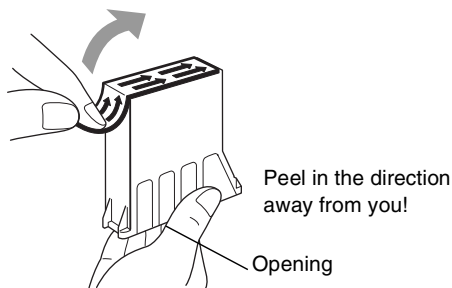

 To prevent spilling ink and staining your hands and clothing, remove the sealing tape gently.

- 7** Each color has its own correct position. Insert each new ink cartridge into the carriage.
- 8** After installing the ink cartridges, close the top cover and control panel cover. Your machine prepares for a “head cleaning” and goes online.

The LCD prompts you to verify that you removed the ink cartridge for each color. Example: Have you removed Blck? 1.Yes 2.No.

- 9** If you removed the ink cartridge, press **1**

—OR—

If you did not remove the ink cartridge, press **2**.

The LCD prompts you to verify that the ink cartridge was a *new* one. Example: Changed to new Blck? 1.Yes 2.No.

- 10** If the ink cartridge you installed is not a brand new one, please be sure to press **2**.

—OR—

For each *new* cartridge, press **1** on the dial pad to automatically reset the ink dot counter for that color. (The ink dot counter enables the machine to notify you when a color is running low.) The machine will enter a cleaning cycle for approximately 3 minutes for each replaced cartridge. The LCD alternately shows *Cleaning and Please Wait*.

When the machine completes the cleaning cycle, the LCD returns to Standby mode condition.

WARNING

If ink gets in your eyes, irrigate them with water immediately and call a doctor if you are concerned.

Caution

- DO NOT remove ink cartridges if you do not need to replace them. If you do so, it may reduce the ink quantity and the printer will not know the quantity of ink left in the cartridge.
- DO NOT shake the ink cartridges, because the ink may spill when you take off the sealing tape.
- If ink stains your body or clothing, wash with soap or detergent immediately.
- If you install an ink cartridge in the wrong color position, you must clean the print head several times before you start printing (after correcting the cartridge installation) because the colors were mixed.
- Once you open an ink cartridge, install it in the machine and use it up within six months of installation. Use unopened ink cartridges by the expiration date written on the cartridge package.
- Brother strongly recommends that you do not refill the ink cartridges provided with your machine. We also strongly recommend that you continue to use only Genuine Brother Brand replacement ink cartridges. Using or attempting to use potentially incompatible inks and/or cartridges in your machine may cause damage to the machine itself and/or it may result in unsatisfactory print quality. Our warranty coverage does not apply to any problem that was caused by the use of unauthorized third party ink and/or cartridges. To protect your investment and guarantee your print quality please continue to replace consumed ink cartridges with only Genuine Brother Branded Supplies.



If the **Ink Empty** message is on the display after you have installed ink cartridges, check that the ink cartridges are installed properly.

If you still cannot solve a problem with your machine, call Brother Customer Service. (See *Brother numbers* on page i.)

G Glossary

ADF (automatic document feeder) The original can be placed in the ADF and scanned one page at a time automatically.

Auto Reduction Reduces the size of incoming faxes.

Automatic fax transmission (MFC-3220C only) Sending a fax without picking up the handset of an external phone.

Automatic fax transmission (FAX-1820C only) Sending a fax without picking up the handset of the machine or pressing **Hook**.

Automatic Redial A feature that enables your machine to redial the last fax number after five minutes if the fax did not go through because the line was busy.

Backup Print Your machine prints a copy of every fax that is received and stored in memory. This is a safety feature so you will not lose messages during a power failure.

Batch Transmission (Black and white faxes only) As a cost savings feature, all delayed faxes to the same fax number will be sent as one transmission.

Brightness Changing the Brightness makes the whole image lighter or darker.

Beeper Volume Volume setting for the beep when you press a key or make an error.

Broadcasting The ability to send the same fax message to more than one location.

Cancel Job Cancels a programmed job, like Delayed Fax or Polling.

CNG tones The special tones (beeps) sent by fax machines during automatic transmission to tell the receiving machine that a fax machine is calling.

Coding method Method of coding the information contained in the original. All fax machines must use a minimum standard of Modified Huffman (MH). Your machine is capable of greater compression methods, Modified Read (MR), Modified Modified Read (MMR) and JPEG, if the receiving machine has the same capability.

- Communication error (or Comm. Error)** An error during fax sending or receiving, usually caused by line noise or static.
- Compatibility group** The ability of one fax unit to communicate with another. Compatibility is assured between ITU-T Groups.
- Contrast** Setting to compensate for dark or light originals, by making faxes or copies of dark originals lighter and light originals darker.
- Delayed Fax** Sends your fax at a specified later time that day.
- Distinctive Ring** A subscriber service purchased from the telephone company that gives you another phone number on an existing phone line. The Brother machine uses the new number to simulate a dedicated fax line.
- Dual Access** Your machine can scan outgoing faxes or scheduled jobs into memory at the same time it is sending a fax or receiving or printing an incoming fax.
- Easy Receive** Enables your machine to respond to CNG tones if you interrupt a fax call by answering it.
- ECM (Error Correction Mode)** Detects errors during fax transmission and resends the pages of the fax that had an error.
- Extension phone** A telephone on the fax number that is plugged into a separate wall jack.
- External phone** A TAD (telephone answering device) or telephone that is plugged into the EXT jack of the machine.
- F/T Ring Time** The length of time that the Brother machine rings (when the Receive Mode setting is Fax/Tel) to notify you to pick up a voice call that it answered.
- Fax Forwarding** Sends a fax received into the memory to another pre-programmed fax number.
- Fax Receive Code** Press this code (* 5 1) when you answer a fax call on an extension or external phone.
- Fax Storage** You can print stored faxes later or retrieve them from another location using Fax Forwarding or Remote Retrieval operations.
- Fax tones** The signals sent by sending and receiving fax machines while communicating information.

Fax/Tel You can receive faxes and telephone calls. Do not use this mode if you are using a telephone answering device (TAD).

Fine resolution Resolution is 203 × 196 dpi. It is used for small print and graphs.

Gray scale The shades of gray available for copying and faxing photographs.

Group number A combination of One-Touch and Speed-Dial numbers that are stored on a One-Touch key or in a Speed-Dial location for Broadcasting.

Help list A printout of the complete Menu table that you can use to program your machine when you do not have the User's Guide with you.

Fax Journal Lists information about the last 200 incoming and outgoing faxes. TX means Transmit. RX means Receive.

Journal Period The pre-programmed time period between automatically printed Fax Journal Reports. You can print the Fax Journal on demand without interrupting the cycle.

LCD (liquid crystal display) The display screen on the machine that shows interactive messages during On-Screen Programming and shows the date and time when the machine is idle.

Manual fax (MFC-3220C only) When you lift the handset of your external telephone or press **Hook** so you can hear the receiving fax machine answer before you press **Black Start** or **Color Start** to begin transmission.

Manual fax (FAX-1820C only) When you lift the handset of the machine or press **Hook** so you can hear the receiving fax machine answer before you press **Black Start** or **Color Start** to begin transmission.

Menu mode Programming mode for changing your machine's settings.

MFL-Pro Suite (MFC-3220C only) Turns your machine into a printer and a scanner if connected to your computer.

OCR (optical character recognition) (MFC-3220C Only) The bundled ScanSoft® TextBridge® software application converts an image of text to text you can edit.

One-Touch Keys on the machine's control panel where you can store numbers for easy dialing. You can store a second number on each key if you press **Shift** and the One-Touch Key together.

Out of Paper Reception Receives faxes into the machine's memory when the machine is out of paper.

Overseas Mode Makes temporary changes to the fax tones to accommodate noise and static on overseas phone lines.

Paging Feature enables your machine to call your pager when a fax is received into its memory.

Pause Allows you to place a 3.5 second delay in the dialing sequence stored on One-Touch keys and Speed-Dial numbers. Press **Redial/Pause** as many times as needed for longer pauses.

Photo resolution A resolution setting that uses varying shades of gray for the best representation of photographs.

Polling The process of a fax machine calling another fax machine to retrieve waiting fax messages.

Pulse A form of rotary dialing on a telephone line.

Quick Dial List A listing of names and numbers stored in One-Touch and Speed-Dial memory, in numerical order.

Real Time Transmission When memory is full, you can send faxes in real time.

Remaining jobs You can check which jobs are waiting in memory and cancel jobs individually.

Remote Access Code Your own four-digit code (---*) that allows you to call and access your machine from a remote location.

Remote Retrieval Access The ability to access your machine remotely from a touch tone phone.

Resolution The number of vertical and horizontal lines per inch. See: Standard, Fine, Super Fine and Photo.

Ring Delay The number of rings before the machine answers in Fax Only mode.

Ring Volume Volume setting for the machine's ring.

- Scanning** The process of sending an electronic image of a paper original into your computer.
- Search** An electronic, alphabetical listing of stored One-Touch, Speed-Dial and Group numbers.
- Speed-Dial** A pre-programmed number for easy dialing. You must press the **Search/Speed Dial** key and then #, and the two digit code to start the dialing process.
- Standard resolution** 203 x 97 dpi. It is used for regular size text and quickest transmission.
- Station ID** The stored information that appears on the top of faxed pages. It includes the sender's name and fax number.
- Super Fine resolution** 392 x 203 dpi. Best for very small print and line art.
- TAD (telephone answering device)** You can connect an external device or answering machine to the EXT. jack of the machine.
- Telephone Answer Code (Fax/Tel mode only)** When the machine answers a voice call, it pseudo/double-rings. You can pick up at an extension phone by pressing this code (**# 5 1**).
- Temporary settings** You can select certain options for each fax transmission and copy without changing the default settings.
- Tone** A form of dialing on the telephone line used for Touch Tone telephones.
- Transmission** The process of sending faxes over the phone lines from your machine to the receiving fax machine.
- Transmission Verification Report** A listing of each transmission, that shows its date, time and number.
- User Settings** A printed report that shows the current settings of the machine.

S Specifications

Product description

General

Memory Capacity	8 MB
Automatic Document Feeder (ADF)	Up to 20 pages Temperature: 68°F - 86°F(20°C - 30°C) Humidity: 50% - 70% Paper: 20 lb Letter size
Paper Tray	100 Sheets (20 lb)
Printer Type	Ink Jet
Print Method	Piezo with 75 × 4 nozzles
LCD (Liquid Crystal Display)	16 characters × 1 line
Power Source	120V AC 50/60Hz
Power Consumption	(MFC-3220C) Minimum: 4W or less Standby: 9W or less (25°C) Peak: Under 32 watts
Power Consumption	(FAX-1820C) Minimum: 5W or less Standby: 13W or less (25°C) Peak: Under 35 watts

Dimensions

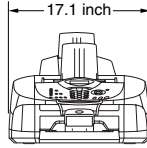

(MFC-3220C)

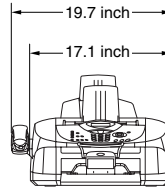

(FAX-1820C)

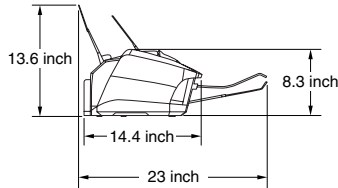

Weight

MFC-3220C: 14.3 lb

FAX-1820C: 15.4 lb

Noise

Operating: 48 dB A or less

Standby: 35 dB A or less

Temperature

Operating: 50°F - 95°F

Best Print

Quality: 68°F - 91°F

Humidity

Operating: 20 to 80% (without condensation)

Best Print

Quality: 20 to 80% (without condensation)

Print media

Paper Input

Paper Tray

- Paper type:
Plain paper, recycled paper, inkjet paper (coated paper), glossy paper, transparencies and envelopes
- Paper size:
Letter, Legal, Executive, A4, A5, A6, JIS_B5, envelopes (commercial No.10, DL, C5, Monarch, JE4), Photo card, Index card.
For more details, see *Paper specifications for the paper tray* on page 2-4.
- Maximum paper tray capacity: Approx. 100 sheets of 20 lb plain paper
- Use only transparencies recommended for inkjet printing.

Paper Output

Up to 50 sheets of Letter plain paper (Face up print delivery to the output paper support)

For inkjet (coated paper) and transparency, we recommend removing printed pages from the output paper support immediately after they exit the machine to avoid smudging.

Legal paper cannot be stacked on the output paper support.

Copy

Color/Monochrome

Color/Mono

Copy Speed

Mono

Up to 12 pages/minute (Letter paper)

Color

Up to 10 pages/minute (Letter paper)

Does not include the time it takes to feed the paper.

Based on Brother standard pattern.

Fast mode

Multiple Copies

Stacks or Sorts up to 99 pages

Enlarge/Reduce

25% to 400% (in increments of 1%)

Resolution

Max. 1200 x 1200 dpi

Fax

Compatibility	ITU-T Group 3
Coding System	MH/MR/MMR/JPEG
Modem Speed	Automatic Fallback 14400 bps:
Original Size	ADF Width: 3.5" to 8.5" ADF Height: 5" to 14"
Scanning Width	8.2 in.
Printing Width	8.03 in.
Gray Scale	256 levels
Polling Types	Standard, Sequential : (B&W only)
Contrast Control	Automatic/Light/Dark (manual setting)
Resolution	<ul style="list-style-type: none">• Horizontal 203 dot/inch (8 dot/mm)• Vertical Standard -<ul style="list-style-type: none">98 line/inch (Black)196 line/inch (Color)Fine - 196 line/inch (Black/Color)Photo - 196 line/inch (Black)Superfine - 392 line/inch (Black)
One-Touch Dial	10 (5 × 2)
Speed-Dial	40 stations
Broadcasting	100 stations
Automatic Redial	1 time in 5 minutes
Auto Answer	0, 1, 2, 3 or 4 rings
Communication Source	Public switched telephone network.
Memory Transmission	Up to 200 ^{*1} /170 ^{*2} pages (MFC-3220C) Up to 480 ^{*1} /400 ^{*2} pages (FAX-1820C)
Out of Paper Reception	Up to 200 ^{*1} /170 ^{*2} pages (MFC-3220C) Up to 480 ^{*1} /400 ^{*2} pages (FAX-1820C)

*1 "Pages" refers to the "Brother Standard Chart No. 1" (a typical business letter, Standard resolution, JBIG code). Specifications and printed materials are subject to change without prior notice.

*2 "Pages" refers to the "ITU-T Test Chart #1" (a typical business letter, Standard resolution, JBIG code). Specifications and printed materials are subject to change without prior notice.

Scanner (MFC-3220C only)

Color/Monochrome	Color/Monochrome
TWAIN Compliant	Yes (Windows® 98/98SE/Me/2000 Professional) Mac OS® 8.6-9.2/Mac OS® X 10.2.1 or greater
WIA Compliant	Yes (Windows® XP)
Resolution	Up to 2,400 × 2,400 dpi (interpolated)* Up to 600 × 1,200 dpi (optical) * Maximum 1200 x 1200 dpi scanning with Windows® XP (resolution up to 2400 x 2400 dpi can be selected by using the Brother scanner utility)
Scanning Speed	Color: up to 9 sec. Mono: up to 4 sec. (Letter size in 100 × 100 dpi)
Original Size	ADF Width: 3.5" to 8.5" ADF Height: 5" to 14"
Scanning Width	8.26 in.
Gray Scale	256 levels



Mac OS® X scanning is supported in Mac OS® X 10.2.1 or greater.

Printer



For FAX-1820C, you can download the Brother Printer Driver and PC Fax Driver from the Brother Solutions Center. Visit us at:

<http://solutions.brother.com>

Printer Driver

Windows® 98/98SE/Me/2000 Professional and XP driver supporting Brother Native Compression mode and bi-directional capability

Apple® Macintosh® QuickDraw® Driver
For Mac OS® 8.6-9.2/Mac OS® X 10.1/10.2.1 or greater

Resolution

Up to 4800 x 1200 optimized dots per inch (dpi)*

1200 x 1200 dots per inch (dpi)

600 x 600 dots per inch (dpi)

600 x 300 dots per inch (dpi)

600 x 150 dots per inch (dpi)

* *Black and White Printing:* The MFC prints using black ink up to 4800 x 1200 optimized dpi when Photo mode is selected in the printer driver.

* *Color Printing:* The MFC uses Brother's OP Technology to automatically vary the printing resolution for producing the highest quality output. Brother's OP Technology is automatically activated during color printing using Photo mode and selects the print resolution appropriate for the printing task up to 4800 x 1200 optimized dpi when printing on photo quality paper.

* Output image quality varies based upon many factors including but not limited to input image resolution and quality and print media.

Print Speed

up to 14 pages/minute (Mono)*

up to 12 pages/minute (Color)*

* Based on Brother standard pattern.

* Letter size in draft mode.

* Does not include the time it takes to feed the paper.

Printing Width

8.03 inches (204 mm)

Disk-Based Fonts

35 TrueType

Interfaces

USB

A Standard Universal Serial Bus cable that is not longer than 6 feet (2.0 m).

Computer requirements

Minimum System Requirements						
Computer Platform & Operating System Version		Processor Minimum Speed	Minimum RAM	Recommended RAM	Available Hard Disk Space	
					Driver	Application Software* ¹
Windows® Operating System	98, 98SE	Pentium 75MHz	24 MB	32 MB	200 MB	100 MB
	Me	Pentium 150MHz	32 MB	64 MB		
	2000 Professional	Pentium 133MHz	64 MB	128 MB		
	XP* ³	Pentium 233MHz			180 MB	
Apple® Macintosh® Operating System	Mac OS® 8.6 -9.2 (Printing, Scanning and PC-FAX Send Only)	All base models meet minimum Requirements	32 MB	64 MB	200 MB	200 MB
	Mac OS® X 10.1/10.2.1 or greater (Printing, Scanning* ^{2,4} , PC-FAX Send and Remote Setup Only)		128 MB	160 MB		
NOTE: All registered trademarks referenced herein are the property of their respective companies.						
For the latest drivers, go to the Brother Solutions Center at http://solutions.brother.com/						



*¹ Application Software is different for Windows® and Macintosh®

*² Scanning is supported in 10.2.1 or greater.

*³ Maximum 1200 x 1200 dpi scanning with Windows® XP. (Resolution up to 2400 x 2400 dpi can be selected using the Brother Scanner Utility.) (MFC-3220C)

*⁴ Dedicated “Scan” key not supported in the Mac® Operations System. (MFC-3220C)

Consumable items

Ink

Black and 3 individual color ink cartridges separate from the print heads.

Service Life of Ink Cartridge

Approximately 500 page/Black cartridge at 5% coverage

Approximately 400 page/Color cartridge at 5% coverage with 600 x 150 dpi resolution (Fast).

These numbers are based on consecutive printing; the numbers will vary based on print frequency and number of pages.

The machine periodically cleans the print head to maintain print quality. This process consumes a small amount of ink.

Index

A

- Access codes, storing and dialing 7-7
- Accessories and suppliesii
- ADF (automatic document feeder) 2-1
- Answering machine (TAD) .. 1-10
 - connecting 1-11
- Automatic
 - dialing 7-1
 - fax receive 5-1
 - Easy Receive 5-5
 - fax redial 6-9
 - transmission 6-4

B

- Broadcasting 6-13
 - setting up Groups for 7-5
- Brother
 - accessories and suppliesii
 - Brother numbers i
 - Customer Service i
 - fax back systemii
 - Frequently Asked Questions (FAQs) i
 - product support i
 - test sheet, sending 1-2
 - Warrantiesiii, iv, vi

C

- Caller ID 5-14
 - print list 5-15
 - view list 5-14
- Canceling
 - Fax Forwarding 8-6
 - fax jobs in memory 6-11

- jobs awaiting redial 6-12
- Paging 8-6
- Cleaning
 - print head 12-11
 - printer platen 12-19
 - scanner 12-18
- CNG tones 1-8
- Connecting
 - external TAD 1-10
 - external telephone 1-9
 - two-line external TAD or telephone 1-15
- Consumable items S-8
- Control panel, overview 1-4
- Copy
 - brightness 10-8
 - color adjustment 10-13
 - contrast 10-12
 - default settings 10-12
 - Enlarge/Reduce 10-6
 - enter Copy mode 10-1
 - keys 10-3
 - multiple 10-2
 - Out of Memory 10-2
 - Page layout 10-10
 - paper 10-7
 - Quality key 10-4
 - quality setting 10-12
 - single 10-2
 - Sort (ADF only) 10-9
 - temporary settings 10-3
- Cordless phone 5-8
- Credit card numbers 7-7
- Custom telephone features on a single line 1-16, 12-9

D

Date and Time	4-1
Delayed Batch Transmission	6-17
Delayed Fax	6-15
Dialing	
a pause	7-8
access codes and credit card numbers	7-7
automatic fax redial	6-9
Groups	6-13
manual	6-1
One-Touch	6-2
Search	6-3
Speed-Dial	6-2
Distinctive Ring	5-10
setting ring pattern	5-12
turning off	5-13
Document	
jam	12-4
size and resolution	2-1
Dual Access	6-10

E

Easy Receive	5-5
ECM (Error Correction Mode)	1-9
Envelopes	2-4, 2-6
Error messages on LCD	12-1
Check Paper	12-1
Comm.Error	12-1
Ink Empty	12-2
Not Registered	6-2
Out of Memory	12-3
while scanning a document	10-2
Extension telephone, using	5-7
External telephone	1-9

F

Fax codes	
changing	5-8, 8-4
Fax Receive Code	5-5, 5-7
Remote Access Code	8-4
Telephone Answer Code	5-7
Fax Forwarding	8-1
changing remotely	8-6, 8-7
programming a number	8-1
Fax Storage	8-3
Backup Print	8-3
Fax Forwarding/Paging	8-1
printing from memory	5-6
turning on	8-3
Fax, stand-alone	
receiving	5-1
at end of conversation	5-6
difficulties	12-8
Easy Receive	5-5
Fax Forwarding	8-1, 8-6
from extension phone	5-7
Polling Receive	5-9
reducing to fit on paper ...	5-6
retrieving from a remote site	8-7
Ring Delay, setting	5-2
Sequential Polling	5-9
sending	6-1
at end of conversation	6-6
automatic	6-4
Broadcasting	6-13
canceling from memory	6-12
color fax	6-9
contrast	6-7
delayed	6-15
enter Fax mode	6-1
from memory (Dual Access)	6-9, 6-10
manual	6-5

- manual transmission 6-5
- overseas 6-14
- Real Time Transmission
 - 6-10
 - redialing 7-8
 - resolution 6-8
- Fax/Tel mode
 - answering at extension
 - phones 5-7
 - double-ringing (voice calls)
 - 5-3
 - F/T Ring Time 5-3
 - Fax Receive Code 5-7
 - receiving faxes 5-7
 - Ring Delay 5-2
 - Telephone Answer Code
 - 5-7
- FCC notices 11-1

G

- Gray scale S-4, S-5
- Groups for Broadcasting 7-5

H

- Hearing aid compatible 4-9
- HELP
 - Help List 9-3
 - navigation keys 3-2
 - LCD instructions 3-1
- Help List 9-4
- Hold 7-9

I

- ink cartridges
 - checking ink volume 12-14
 - replacing 12-20
- Ink Dot Counter 12-20

J

- Jacks
 - convert to RJ11 jack
 - triplex adapter 1-13
- EXT
 - external telephone 1-10
 - TAD (answering machine)
 - 1-10
- Jams
 - original 12-4
 - paper 12-5

L

- LCD (liquid crystal display)
 - 1-4, 9-3, 9-4

M

- Maintenance, routine 12-18
- Manual
 - dialing 7-9
 - receive 5-1
 - transmission 6-5
- Memory Storage 3-1
- Menu Selection Table 3-1
- Mode, entering
 - Copy 10-1
 - Fax 6-1
- Multi-line connections
 - (PBX) 1-16

O

- One-Touch numbers
 - changing 7-4
 - dialing 6-2
 - storing 7-1
- Options key (copying)
 - Brightness 10-8
 - Paper Size 10-8
 - Paper Type 10-7
- Out of Area 5-14

P

- Paging 8-1, 8-2
 - programming your pager
 - number 8-1
- Paper 2-3, S-3
 - capacity 2-4
 - jam 12-5
 - Size 4-6
 - Type 4-6
- Phone line
 - connections 1-11
 - difficulties 12-9
 - multi-line (PBX) 1-16
 - roll over lines 1-13
 - two-line phone system 1-13
- Polling 5-9
- Power failure 3-1
- Print
 - area 2-6
 - difficulties 12-8
 - drivers S-6
 - fax from memory 5-6
 - improving quality 12-11
 - jam 12-5
 - paper jam 12-5
 - report 9-3
 - resolution S-6
 - specifications S-6

Q

- Quality key (copying) 10-3

R

- Receive Mode
 - External TAD 5-1
 - Fax Only 5-1
 - Fax/Tel 5-1
 - Manual 5-1
- Redial/Pause 6-9

Reducing

- copies 10-6
- incoming faxes 5-6
- Remote Retrieval 8-5
 - access code 8-4, 8-5
 - commands 8-6
 - getting your faxes 8-7
- Reports 9-1
 - Caller ID List 5-15
 - Fax Journal 9-3
 - Help List 9-3
 - How to print 9-3, 9-4
 - Quick-Dial List 9-3
 - Transmission Verification
 - 9-1
 - User Settings 9-3
- Resolution
 - copy S-3
 - fax (Standard, Fine, SuperFine, Photo) S-4
 - print S-6
 - scan S-5
 - setting for next fax 6-8
- Ring Delay, setting 5-2

S

- Safety Instructions vii, 11-5
- Setup
 - Date and Time 4-1
 - Station ID (fax header)
 - entering text 4-2
- Shipping the machine 12-15
- Speed-Dial
 - changing 7-4
 - dialing 6-2
 - storing 7-4

T

TAD (telephone answering device), external	1-10, 1-15, 5-1
connecting	1-10, 1-11
Receive Mode	5-1
recording OGM	1-12
with two-line jack	1-15
Temporary copy settings	10-3
Text, entering	4-3
special characters	4-4
Tone signals on Pulse line	7-8
Troubleshooting	12-1
checking ink volume	12-14
error messages on LCD	12-1
if you are having difficulty	
incoming calls	12-9
phone line difficulties	12-9
printer difficulties	12-9
printing or receiving faxes	12-8
sending faxes	12-9
original jam	12-4
paper jam	12-5
print quality	12-11
Two-line phone system	1-13

V

Volume, setting	4-7
beeper	4-7
handset	4-9
Volume Amplify (for hearing-impaired)	4-10
ring	4-7
speaker	4-8

W

Warranties	iii
Canada	vi
Notice-Disclaimer	iii
USA	iv
World Wide Web	i

Remote Retrieval Access card

If you plan to receive fax messages while away from your machine, carrying the Remote Retrieval Access Card printed below will serve as a convenient reminder of the retrieval procedures. Simply cut out the card and fold it to fit your wallet or organizer. Keeping it handy will help you derive the full benefit of your machine's Paging, Fax Forwarding and Remote Retrieval features.

REMOTE RETRIEVAL ACCESS CARD

Using Remote Access Code

- 1 Dial your fax number from a telephone or fax machine using touch tone.
- 2 When your machine answers, immediately enter your Remote Access Code (3 digits followed by *).
- 3 Your machine signals the kinds of messages it received:
1 long beep — Fax messages
No beeps — No messages.
- 4 After 2 short beeps, enter a command.
- 5 Press **90** to reset your machine when you finish.
- 6 Hang up.

CHECK RECEIVING STATUS
Press **971**
1 long beep — Fax messages
3 short beeps — No messages

CHANGE RECEIVE MODE
Press **98**
then for External TAD, press **1**.
Fax/Tel, press **2**.
Fax Only, press **3**.

EXIT REMOTE OPERATION
Press **90**.

Changing Remote Access Code

When you are at the machine:

- 1 Press **Menu/Set**, 2, 5, 3.
- 2 Enter a three-digit number from 000 to 999.
The * cannot be changed.
- 3 Press **Menu/Set**.
- 4 Press **Stop/Exit**.

Remote Commands

CHANGE PAGING FAX FORWARDING SETTING

Press 95.

Then to Turn feature Off, press 1.

Select Fax Forwarding, press 2.

Select Paging, press 3.

Fold ←

Program Fax Forwarding Number, press 4. Enter the new fax number where you want your fax messages forwarded followed by **##**.

Turn Fax Storage On, press 6.

Turn Fax Storage Off, press 7.

RETRIEVE A FAX

Press 96.

Then to

Retrieve all faxes, press 2.

then enter the number of remote fax machine followed by **##**.

After the beep, hang up and wait.

Erase all fax messages, press 3.

← Fold

EQUIPMENT ATTACHMENT LIMITATIONS (Canada only)

NOTICE

This product meets the applicable Industry Canada technical specifications.

NOTICE

The Ringer Equivalence Number is an indication of the maximum number of devices allowed to be connected to a telephone interface. The termination on an interface may consist of any combination of devices subject only to the requirement that the sum of the RENs of all the devices does not exceed five.

brother®

Brother International Corporation
100 Somerset Corporate Boulevard
P.O. Box 6911
Bridgewater, NJ 08807-0911 USA

Brother International Corporation (Canada) Ltd.
1 rue Hôtel de Ville,
Dollard-des-Ormeaux, QC, CANADA H9B 3H6

**Visit us on the World Wide Web
<http://www.brother.com>**

These machines are made for use in the USA and CANADA only. We cannot recommend using them overseas because it may violate the Telecommunications Regulations of that country and the power requirements of your multi-function center may not be compatible with the power available in foreign countries. **Using USA or CANADA models overseas is at your own risk and may void your warranty.**

USA
Version B