

MFC-5440CN

MFC-5840CN

.....

brother

Version A

If you need to call Customer Service

Please complete the following information for future reference:

Model Number: MFC-5440CN and MFC-5840CN
(Circle your model number)

Serial Number:* _____

Date of Purchase: _____

Place of Purchase: _____

* The serial number is on the back of the unit. Retain this User's Guide with your sales receipt as a permanent record of your purchase, in the event of theft, fire or warranty service.

Register your product on-line at

<http://www.brother.com/registration>

By registering your product with Brother International Corporation, you will be recorded as the original owner of the product. Your registration with Brother:

- may serve as confirmation of the purchase date of your product should you lose your receipt;
- may support an insurance claim by you in the event of product loss covered by insurance; and,
- will help us notify you of enhancements to your product and special offers.

The most convenient and efficient way to register your new product is on-line at <http://www.brother.com/registration>

Brother numbers

IMPORTANT

For technical help, you must call the country where you bought the MFC. Calls must be made **from within** that country.

Register your product

By registering your product with Brother International Corporation, you will be recorded as the original owner of the product. Your registration with Brother:

- may serve as confirmation of the purchase date of your product should you lose your receipt;
- may support an insurance claim by you in the event of product loss covered by insurance; and,
- will help us notify you of enhancements to your product and special offers.

Please complete and fax the Brother Warranty Registration And Test Sheet or, for your convenience and most efficient way to register your new product, register on-line at

<http://www.brother.com/registration>

Frequently asked questions (FAQs)

The Brother Solutions Center is our one-stop resource for all your Fax Machine/Multi-Function Center needs. You can download the latest software and utilities, read FAQs and troubleshooting tips, and go to the “Solutions” section to learn how to get the most from your Brother product.

<http://solutions.brother.com>



You can check here for Brother driver updates.

For Customer Service

In USA: 1-800-284-4329 (voice)
1-901-379-1215 (fax)
1-800-284-3238 (TTY service for the hearing-impaired)

In Canada: 1-877-BROTHER (voice)
(514) 685-4898 (fax)

Service Center Locator (USA only)

For the location of a Brother authorized service center, call 1-800-284-4357.

Service Center Locations (Canada only)

For the location of a Brother authorized service center, call 1-877-BROTHER.

Brother fax back system (USA only)

Brother has installed an easy-to-use fax back system, so you can get instant answers to common technical questions and product information for all Brother products. This system is available 24 hours a day, 7 days a week. You can use the system to receive faxed instructions and an Index of fax back subjects.

In USA only: 1-800-521-2846

Ordering accessories and supplies

For best quality results use only genuine Brother accessories, which are available at most Brother retailers. If you cannot find the accessory you need and you have a Visa, MasterCard, Discover, or American Express credit card, you can order accessories directly from Brother. (In the USA, you can visit us online for a complete selection of the Brother accessories and supplies that are available for purchase.)

In USA: 1-888-879-3232 (voice)
1-800-947-1445 (fax)

<http://www.brothermall.com>

In Canada: 1-877-BROTHER (voice)

Description	Item
Ink Cartridge Standard<black>	LC41BK (Prints up to 500 pages)
Ink Cartridge High Yield<black>	LC41HYBK (Prints up to 900 pages)
Ink Cartridge<cyan>(blue)	LC41C (Prints up to 400 pages)
Ink Cartridge<magenta>(red)	LC41M (Prints up to 400 pages)
Ink Cartridge<yellow>	LC41Y (Prints up to 400 pages)
Premium Glossy Photo Paper (Letter size / 20 sheets)	BP60 GLL
Matte Inkjet Paper (Letter size / 25 sheets)	BP60 ML
Inkjet Plain Paper (Letter size / 250 sheets)	BP60 PL
Telephone Line Cord	LG3077001
Power Protector for A/C Power Telephone Line Surges and Voltage Spikes (2 outlets)	QPD120
Power Protector for A/C Power Telephone Line Surges and Voltage Spikes (8 outlets)	FX120
User's Guide	LF5886001 (English for USA and Canada) LF5895001 (French For Canada)

Notice - Disclaimer of Warranties (USA and Canada)

BROTHER'S LICENSOR(S), AND THEIR DIRECTORS, OFFICERS, EMPLOYEES OR AGENTS (COLLECTIVELY BROTHER'S LICENSOR) MAKE NO WARRANTIES, EXPRESS OR IMPLIED, INCLUDING WITHOUT LIMITATION THE IMPLIED WARRANTIES OF MERCHANTABILITY AND FITNESS FOR A PARTICULAR PURPOSE, REGARDING THE SOFTWARE. BROTHER'S LICENSOR(S) DOES NOT WARRANT, GUARANTEE OR MAKE ANY REPRESENTATIONS REGARDING THE USE OR THE RESULTS OF THE USE OF THE SOFTWARE IN TERMS OF ITS CORRECTNESS, ACCURACY, RELIABILITY, CURRENTNESS OR OTHERWISE. THE ENTIRE RISK AS TO THE RESULTS AND PERFORMANCE OF THE SOFTWARE IS ASSUMED BY YOU. THE EXCLUSION OF IMPLIED WARRANTIES IS NOT PERMITTED BY SOME STATES IN THE USA AND SOME PROVINCES IN CANADA. THE ABOVE EXCLUSION MAY NOT APPLY TO YOU.

IN NO EVENT WILL BROTHER'S LICENSOR(S) BE LIABLE TO YOU FOR ANY CONSEQUENTIAL, INCIDENTAL OR INDIRECT DAMAGES (INCLUDING DAMAGES FOR LOSS OF BUSINESS PROFITS, BUSINESS INTERRUPTION, LOSS OF BUSINESS INFORMATION, AND THE LIKE) ARISING OUT OF THE USE OR INABILITY TO USE THE SOFTWARE EVEN IF BROTHER'S LICENSOR HAS BEEN ADVISED OF THE POSSIBILITY OF SUCH DAMAGES. BECAUSE SOME STATES IN THE USA AND SOME PROVINCES IN CANADA DO NOT ALLOW THE EXCLUSION OR LIMITATION OF LIABILITY FOR CONSEQUENTIAL OR INCIDENTAL DAMAGES, THE ABOVE LIMITATIONS MAY NOT APPLY TO YOU. IN ANY EVENT BROTHER'S LICENSOR'S LIABILITY TO YOU FOR ACTUAL DAMAGES FROM ANY CAUSE WHATSOEVER, AND REGARDLESS OF THE FORM OF THE ACTION (WHETHER IN CONTRACT, TORT (INCLUDING NEGLIGENCE), PRODUCT LIABILITY OR OTHERWISE), WILL BE LIMITED TO \$50.

Compilation and Publication Notice

Under the supervision of Brother Industries Ltd., this manual has been compiled and published, covering the latest product descriptions and specifications.

The contents of this manual and the specifications of this product are subject to change without notice.

Brother reserves the right to make changes without notice in the specifications and materials contained herein and shall not be responsible for any damages (including consequential) caused by reliance on the materials presented, including but not limited to typographical and other errors relating to the publication.

Brother® One Year Limited Warranty and Replacement Service (USA only)

Who is covered:

- This limited warranty ("warranty") is given only to the original end-use/retail purchaser (referred to in this warranty as "Original Purchaser") of the accompanying product, consumables and accessories (collectively referred to in this warranty as "this Product").
- If you purchased a product from someone other than an authorized Brother reseller in the United States or if the product was used (including but not limited to floor models or refurbished product), prior to your purchase you are not the Original Purchaser and the product that you purchased is not covered by this warranty.

What is covered:

- This Product includes a Machine and Consumable and Accessory Items. Consumable and Accessory Items include but are not limited to print head, toner, drums, ink cartridges, print cartridges, refill ribbons, therma PLUS paper and thermal paper.
- Except as otherwise provided herein, Brother warrants that the Machine and the accompanying Consumable and Accessory Items will be free from defects in materials and workmanship, when used under normal conditions.
- This warranty applies only to products purchased and used in the United States. For products purchased in, but used outside, the United States, this warranty covers only warranty service within the United States (and does not include shipping outside the United States).

What is the length of the Warranty Periods:

- Machines: one year from the original purchase date.
- Accompanying Consumable and Accessory Items: 90 days from the original purchase date or the rated life of consumable, whichever comes first.

What is NOT covered:

This warranty does not cover:

- (1) Physical damage to this Product;
- (2) Damage caused by improper installation, improper or abnormal use, misuse, neglect or accident (including but not limited to transporting this Product without the proper preparation and/or packaging);
- (3) Damage caused by another device or software used with this Product (including

but not limited to damage resulting from use of non Brother®-brand parts and Consumable and Accessory Items);

- (4) Consumable and Accessory Items that expired in accordance with a rated life; and,
- (5) Problems arising from other than defects in materials or workmanship.
- (6) Normal Periodic Maintenance Items, such as Paper Feeding Kit, Fuser and Laser Units.

This limited warranty is VOID if this Product has been altered or modified in any way (including but not limited to attempted warranty repair without authorization from Brother and/or alteration/removal of the serial number).

What to do if you think your Product is eligible for warranty service:

Report your issue to either our Customer Service Hotline at 1-800-284-4329 for Fax, MFC and DCP and 1-800-276-7746 for Printers, or to a Brother Authorized Service Center **within the applicable warranty period.** Supply Brother or the Brother Authorized Service Center with a copy of your dated bill of sale showing that this Product was purchased within the U.S. For the name of local Brother Authorized Service Center(s), call 1-800-521-2846.

What Brother will ask you to do:

After contacting Brother or a Brother Authorized Service Center, you may be required to deliver (by hand if you prefer) or send the Product properly packaged, freight prepaid, to the Authorized Service Center together with a photocopy of your bill of sale.

You are responsible for the cost of shipping, packing product, and insurance (if you desire). You are also responsible for loss or damage to this Product in shipping.

What Brother will do:

If the problem reported concerning your Machine and/or accompanying Consumable and Accessory Items is covered by this warranty and if you first reported the problem to Brother or an Authorized Service Center within the applicable warranty period, Brother or its Authorized Service Center will repair or replace the Machine and/or accompanying Consumable and Accessory Items at no charge to you for parts or labor. The decision as to whether to repair or replace the Machine and/or accompanying Consumable and Accessory Items is made

Brother® One Year Limited Warranty and Replacement Service (USA only)

by Brother in its sole discretion. Brother reserves the right to supply a refurbished or remanufactured replacement Machine and/or accompanying Consumable and Accessory Items and use refurbished parts provided such replacement products conform to the manufacturer's specifications for new product/parts. The repaired or replacement Machine and/or accompanying Consumable and Accessory Items will be returned to you freight prepaid or made available for you to pick up at a conveniently located Authorized Service Center.

If the Machine and/or accompanying Consumable and Accessory Items are not covered by this warranty (either stage), you will be charged for shipping the Machine and/or accompanying Consumable and Accessory Items back to you and charged for any service and/or replacement parts/products at Brother's then current published rates.

The foregoing are your sole (i.e., only) and exclusive remedies under this warranty.

What happens when Brother elects to replace your Machine:

When a replacement Machine is authorized by Brother, and you have delivered the Machine to an Authorized Service Center, the Authorized Service Center will provide you with a replacement Machine after receiving one from Brother. If you are dealing directly with Brother, Brother will send to you a replacement Machine with the understanding that you will, after receipt of the replacement Machine, supply the required proof of purchase information, together with the Machine that Brother agreed to replace. You are then expected to pack the Machine that Brother agreed to replace in the package from the replacement Machine and return it to Brother using the pre-paid freight bill supplied by Brother in accordance with the instructions provided by Brother. Since you will be in possession of two machines, Brother will require that you provide a valid major credit card number. Brother will issue a hold against the credit card account number that you provide until Brother receives your original Product and determines that your original Product is entitled to warranty coverage. Your credit card will be charged up to the cost of a new Product only if: (i) you do not return your original Product to Brother within five (5) business days; (ii) the problems with your original Product are not covered by the limited warranty; (iii) the proper packaging instructions are not followed and has caused

damage to the product; or (iv) the warranty period on your original Product has expired or has not been sufficiently validated with a copy of the proof of purchase (bill of sale). The replacement Machine you receive (even if refurbished or remanufactured) will be covered by the balance of the limited warranty period remaining on the original Product, plus an additional thirty (30) days. You will keep the replacement Machine that is sent to you and your original Machine shall become the property of Brother. **Retain your original Accessory Items and a copy of the return freight bill, signed by the courier.**

Limitations:

Brother is not responsible for damage to or loss of any equipment, media, programs or data related to the use of this Product. Except for that repair or replacement as described above, Brother shall not be liable for any direct, indirect, incidental or consequential damages or specific relief. Because some states do not allow the exclusion or limitation of consequential or incidental damages, the above limitation may not apply to you.

THIS WARRANTY IS GIVEN IN LIEU OF ALL OTHER WARRANTIES, WRITTEN OR ORAL, WHETHER EXPRESSED BY AFFIRMATION, PROMISE, DESCRIPTION, DRAWING, MODEL OR SAMPLE. ANY AND ALL WARRANTIES OTHER THAN THIS ONE, WHETHER EXPRESS OR IMPLIED, INCLUDING IMPLIED WARRANTIES OF MERCHANTABILITY AND FITNESS FOR A PARTICULAR PURPOSE, ARE HEREBY DISCLAIMED.

- This Limited Warranty is the only warranty that Brother is giving for this Product. It is the final expression and the exclusive and only statement of Brother's obligations to you. It replaces all other agreements and understandings that you may have with Brother or its representatives.
- This warranty gives you certain rights and you may also have other rights that may vary from state to state.
- This Limited Warranty (and Brother's obligation to you) may not be changed in any way unless you and Brother sign the same piece of paper in which we (1) refer to this Product and your bill of sale date, (2) describe the change to this warranty and (3) agree to make that change.

Important: *We recommend that you keep all original packing materials, in the event that you ship this Product.*

BROTHER MULTIFUNCTION CENTER/FACSIMILE MACHINE LIMITED WARRANTY (Canada only)

Pursuant to this limited warranty of 1 year from the date of purchase for labour and parts, Brother International Corporation (Canada) Ltd. ("Brother"), or its Authorized Service Centers, will repair this MFC/Facsimile machine free of charge if defective in material or workmanship. This Limited Warranty does not include cleaning, consumables (including, without limitation, print cartridges, print head, toner and drum) or damage caused by accident, neglect, misuse or improper installation or operation, any damage caused from service, maintenance, modifications, or tampering by anyone other than a Brother Authorized Service Representative, or from the use of supplies or consumable items that are non-Brother products. Operation of the MFC/Facsimile machine in excess of the specifications or with the Serial Number or Rating Label removed shall be deemed abuse and all repairs thereafter shall be the sole liability of the end-user/purchaser. In order to obtain warranty service, the MFC/Facsimile machine must be delivered or shipped freight prepaid by the end user/purchaser to a "Brother" Authorized Service Center, together with your Proof of Purchase in the form of a Sales Receipt.

For laser products: Failure to remove the Toner Cartridge (and Toner Drum Unit on applicable models) during shipping will cause severe damage to the MFC/Facsimile and will VOID the Warranty. (Refer to your User's Guide for proper packaging.)

For ink-jet products: Do not remove the ink cartridges during shipping. Damage to your print head resulting from packing without the ink cartridges will VOID your warranty. (Refer to your User's Guide for proper packaging.)

BROTHER DISCLAIMS ALL OTHER WARRANTIES EXPRESSED OR IMPLIED INCLUDING, WITHOUT LIMITATION, ANY IMPLIED WARRANTIES OF MERCHANTABILITY OR FITNESS FOR A PARTICULAR PURPOSE, EXCEPT TO THE EXTENT THAT ANY WARRANTIES IMPLIED BY LAW CANNOT BE VALIDLY WAIVED.

No oral or written information, advice or representation provided by Brother, its Authorized Service Centers, Distributors, Dealers, Agents or employees, shall create another warranty or modify this warranty. This warranty states Brother's entire liability and your exclusive remedy against Brother for any failure of the MFC/Facsimile machine to operate properly.

Neither Brother nor anyone else involved in the development, production, or delivery of this MFC/Facsimile machine shall be liable for any indirect, incidental, special, consequential, exemplary, or punitive damages, including lost profits, arising from the use of or inability to use the product, even if advised by the end user/purchaser of the possibility of such damages. Since some Provinces do not allow the above limitation of liability, such limitation may not apply to you.

This Limited Warranty gives you specific legal rights and you may also have other rights which vary from Providence to Providence.

Warranty Service is available at Brother Authorized Service Centers throughout Canada. For Technical Support or for the name and location of your nearest Authorized Service Center call 1-877-BROTHER.

Internet support: support@brother.ca or browse

Brother's Web Site: www.brother.com

Brother International Corporation (Canada) Ltd.

1 Rue Hôtel de Ville

Dollard-Des-Ormeaux, QC H9B 3H6







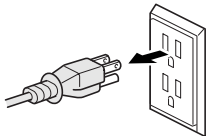

At your side.
brother®

Safety precautions

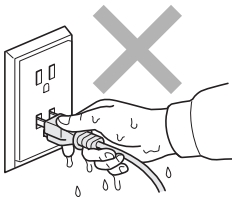
To use the MFC safely

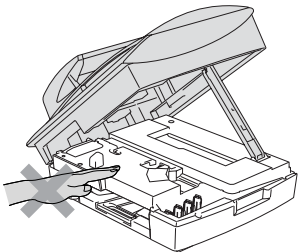
Please refer to these instructions for later reference and before attempting any maintenance.

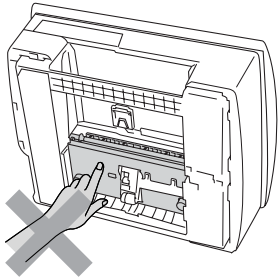
WARNING

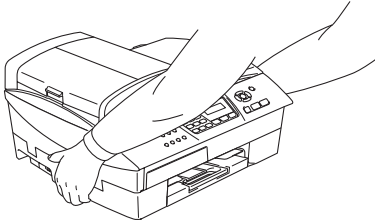
	<p>There are high voltage electrodes inside the MFC. Before you clean the MFC, make sure you have unplugged the telephone line cord first and then the power cord from the AC power outlet.</p> 		<p>Do not handle the plug with wet hands. Doing this might cause an electrical shock.</p> 
	<p>To prevent injuries, be careful not to put your hands on the edge of the MFC under the scanner cover.</p> 		<p>To prevent injuries, be careful not to touch the area shaded in the illustration.</p> 
	<p>When you move the MFC, place a hand at each side of the unit and grasp the grooved panels so you are supporting the base when you lift it. (See the illustration on the right.) Do not carry the MFC by holding the scanner cover.</p> 		



Most of the illustrations in this User's Guide show the MFC-5440CN.

 **WARNING**

- Use caution when installing or modifying telephone lines. Never touch telephone wires or terminals that are not insulated unless the telephone line has been disconnected at the wall jack. Never install telephone wiring during a lightning storm. Never install a telephone wall jack in a wet location.
- This product must be installed near an AC power outlet that is easily accessible. In case of emergencies, you must disconnect the power cord from the AC power outlet in order to shut off power completely.
- To reduce the risk of shock or fire, use only a No. 26 AWG or larger telecommunication line cord.

 **Caution**

- Lightning and power surges can damage this product! We recommend that you use a quality surge protection device on the AC power line and on the telephone line, or unplug the cords during a lightning storm.

IMPORTANT SAFETY INSTRUCTIONS

When using your telephone equipment, basic safety precautions should always be followed to reduce the risk of fire, electric shock and injury to persons, including the following:

1. Do not use this product near water, for example, near a bath tub, wash bowl, kitchen sink or washing machine, in a wet basement or near a swimming pool.
2. Avoid using this product during an electrical storm. There may be a remote risk of electric shock from lightning.
3. Do not use this product to report a gas leak in the vicinity of the leak.
4. Use only the power cord provided with the MFC.

SAVE THESE INSTRUCTIONS

Choosing a location

Place your MFC on a flat, stable surface that is free of vibration and shocks, such as a desk. Put the MFC near a telephone wall jack and a standard, grounded AC power outlet. Choose a location where the temperature remains between 50°F and 95°F (10°-35°C). To make sure the ADF can feed the maximum of 35 pages, keep the temperature between 68°F-86°F (20°-30°C).

! Caution

- Avoid placing your MFC in a high-traffic area.
- Avoid placing your MFC on the carpet.
- Do not place near heaters, air conditioners, water, chemicals, or refrigerators.
- Do not expose the MFC to direct sunlight, excessive heat, moisture, or dust.
- Do not connect your MFC to electrical outlets controlled by wall switches or automatic timers.
- Disruption of power can wipe out information in the MFC's memory.
- Do not connect your MFC to electrical outlets on the same circuit as large appliances or other equipment that might disrupt the power supply.
- Avoid interference sources, such as speakers or the base units of cordless phones.

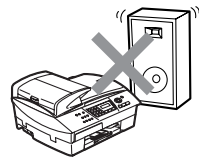
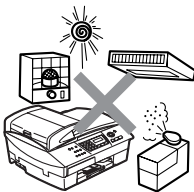

Quick Reference Guide

Sending faxes

Automatic Transmission

- 1 If it is not illuminated in green, press  (**Fax**).
- 2 Load your document.
- 3 Enter the fax number using Speed-Dial, Search or the dial pad.
- 4 Press **Black Start** or **Color Start**.

Storing numbers

Storing Speed-Dial numbers

- 1 Press **Menu/Set**, **2**, **3**, **1**.
- 2 Using the dial pad, enter a two-digit Speed-Dial location number, and then press **Menu/Set**.
- 3 Enter a number (up to 20 digits), and then press **Menu/Set**.
- 4 Enter a name up to 15 characters (or leave it blank), and then press **Menu/Set**.
- 5 Press **Stop/Exit**.

Dialing operations

Speed-Dialing

- 1 If it is not illuminated in green, press  (**Fax**).
- 2 Load your document.
- 3 Press **Search/Speed Dial**, press #, and then press the two-digit Speed-Dial number.
- 4 Press **Black Start** or **Color Start**.

Using Search

- 1 If it is not illuminated in green, press  (**Fax**).
- 2 Load your document.
- 3 Press **Search/Speed Dial**, and then enter the first letter of the name you're looking for.
- 4 Press ◀ or ▶ to search the memory.
- 5 Press **Black Start** or **Color Start**.

Making copies

- 1 Press  (**Copy**) to illuminate it in green.
- 2 Load your document.
- 3 Press **Black Start** or **Color Start**.

Table of Contents

1

Introduction	1-1
Using this Guide	1-1
Finding information	1-1
Symbols used in this Guide	1-1
Control panel overview	1-2
Turning the MFC on and off	1-5
On/Off Setting	1-6
Load documents	1-7
Using the automatic document feeder (ADF)	1-7
Recommended environment	1-7
Using the scanner glass	1-9
About paper	1-10
Recommended Paper	1-10
Handling and using special paper	1-11
Paper type and size for each operation	1-12
Paper weight, thickness and capacity	1-13
Paper capacity of the output paper tray	1-13
Printable area	1-14
How to load paper, envelopes and post cards	1-15
To load paper or other media	1-15
To load paper in paper tray#2 (MFC-5840CN only)	1-17
To load envelopes	1-20
To load post cards	1-21
About fax machines	1-22
Custom features	1-22
Do you have Voice Mail on the phone line?	1-22
Why should there be problems?	1-22
How can you avoid possible problems?	1-22
Fax tones and handshake	1-23
ECM (Error Correction Mode)	1-24

2

Getting started	2-1
Initial Setup	2-1
Setting the Date and Time	2-1
Setting Tone and Pulse dialing mode	2-1
Setting the Station ID	2-2
General Setup	2-3
Setting the Mode Timer	2-3
Setting the Paper Type	2-3
Setting the Paper Size	2-4

Setting the Ring Volume	2-5
Setting the Beeper Volume	2-5
Setting the Speaker Volume	2-6
Turning on Automatic Daylight Savings Time	2-6
Setting the LCD Contrast	2-7
Setting the Tray Use for Copy mode (MFC-5840CN only)	2-7
Setting the Tray Use for Fax mode (MFC-5840CN only)	2-8

3

Setup Send	3-1
How to enter Fax mode	3-1
How to dial	3-1
Manual dialing	3-1
Speed-Dialing	3-2
Search	3-2
Fax Redial	3-2
How to Fax (B&W and Color)	3-3
Color fax transmission	3-3
Faxing from the ADF	3-3
Faxing from the scanner glass	3-4
Automatic transmission	3-5
Manual transmission	3-5
Out of Memory message	3-6
Basic sending operations	3-7
Sending faxes using multiple settings	3-7
Contrast	3-7
Fax Resolution	3-8
Dual Access (Not available for color faxes)	3-9
Real Time Transmission	3-10
Checking job status	3-11
Canceling a fax in progress	3-11
Canceling a scheduled job	3-11
Advanced sending operations	3-12
Broadcasting (Not available for color faxes)	3-12
Overseas Mode	3-13
Delayed Fax (Not available for color faxes)	3-14
Setting up Polled Transmit (Not available for color faxes)	3-14
Delayed Batch Transmission (Not available for color faxes)	3-15
Faxing A4 size documents from the scanner glass	3-15

4

Setup Receive	4-1
Basic receiving operations	4-1
Choosing the Receive Mode	4-1
To select or change your Receive Mode	4-2
Setting the Ring Delay	4-2
Setting the F/T Ring Time (Fax/Tel mode only).....	4-3
Easy Receive	4-4
Printing a reduced incoming fax (Auto Reduction)	4-5
Printing a fax from the memory	4-5
Polling	4-6
Setting up Polling Receive	4-6
Setting up Sequential Polling Receive	4-6

5

Quick-Dial numbers and dialing options	5-1
Storing numbers for easy dialing	5-1
Storing Speed-Dial numbers	5-1
Changing Speed-Dial numbers	5-2
Setting up Groups for Broadcasting	5-3
Dialing options	5-5
Access codes and credit card numbers.....	5-5
Pause	5-5
Tone or Pulse	5-6

6

Remote Fax Options (Not available for color faxes)	6-1
Setting up Fax Forwarding	6-1
Programming your pager number.....	6-2
Setting Fax Storage.....	6-3
Setting PC Fax Receive	6-3
Turning off Remote Fax Options	6-4
Setting your Remote Access Code.....	6-4
Remote Retrieval.....	6-5
Using your Remote Access Code.....	6-5
Remote commands	6-6
Retrieving fax messages	6-7
Changing your Fax Forwarding number	6-7

7

Printing reports	7-1
Fax settings and activity	7-1
Customizing the Transmission Verification Report.....	7-1
Setting the Journal Period	7-2
Printing reports	7-3
How to print a report.....	7-3

Making copies	8-1
Using the MFC as a copier	8-1
Enter Copy mode.....	8-1
Making a single copy	8-2
Making multiple copies	8-2
Stop copying	8-2
Using the temporary Copy keys.....	8-3
Increasing copy speed or quality	8-4
Enlarging or reducing the image copied	8-5
Setting the paper type (MFC-5440CN only)	8-6
Using the Tray Select key (MFC-5840CN only).....	8-7
Changing the temporary copy settings	8-8
Setting paper type (MFC-5840CN only)	8-9
Setting paper size.....	8-9
Adjusting brightness	8-10
Adjusting contrast	8-11
Sorting copies using the ADF	8-11
Making N in 1 copies or a poster (Page Layout)	8-12
Changing the default copy settings.....	8-16
Increasing copy speed or quality	8-16
Adjusting brightness	8-16
Adjusting contrast	8-16
Adjusting color saturation	8-17
Out of Memory message	8-17
Legal limitations	8-18

Walk-Up PhotoCapture Center™ (MFC-5840CN only)	9-1
Introduction.....	9-1
PhotoCapture Center™ requirements	9-2
Getting started	9-3
Printing the Index (Thumbnails).....	9-5
Printing images	9-6
DPOF printing.....	9-8
Changing the default settings	9-9
Increasing print speed or quality.....	9-9
Setting the paper & size	9-9
Adjusting brightness	9-10
Adjusting contrast	9-10
Color enhancement (True2Life®).....	9-10
Cropping	9-12
Borderless	9-12
Understanding the Error Messages	9-13
Using PhotoCapture Center™ from your PC.....	9-14
Using PhotoCapture Center™ for scanning documents....	9-14

Important information	10-1
Standard telephone and FCC Notices	
These notices are in effect on models sold and used in the United States only.....	10-1
Federal Communications Commission (FCC)	
Declaration of Conformity (USA only)	10-3
Important	10-4
Industry Canada Compliance Statement (Canada only).....	10-4
For your safety.....	10-4
LAN connection	10-4
International ENERGY STAR® Compliance Statement	10-5
Important safety instructions.....	10-6
Trademarks	10-8

Troubleshooting and routine maintenance	11-1
Troubleshooting	11-1
Error messages	11-1
Document jams.....	11-5
Document is jammed in the top of the ADF unit.	11-5
Document is jammed inside the ADF unit.	11-5
Printer jam or paper jam	11-6
Paper is jammed inside the paper tray	11-6
Paper is jammed inside the MFC	11-7
If you are having difficulty with your MFC.....	11-9
Compatibility	11-14
How to improve print quality	11-15
Cleaning the print head	11-15
Checking the print quality	11-16
Checking the printing alignment	11-18
Checking the ink volume	11-19
Packing and shipping the MFC.....	11-20
Routine maintenance.....	11-23
Cleaning the scanner.....	11-23
Cleaning the MFC printer platen.....	11-24
Replacing the ink cartridges	11-25

Appendix A	A-1
Setting up telephone services	A-1
Distinctive Ring.....	A-1
What does your telephone company's 'Distinctive Ring' do?.....	A-1
What does Brother's 'Distinctive Ring' do?	A-2
Do you have Voice Mail?.....	A-2

Before you choose the ring pattern to register	A-3
Registering the Distinctive Ring pattern.....	A-4
Turning off the Distinctive Ring.....	A-4
Caller ID.....	A-5
Viewing Caller ID List.....	A-6
Printing Caller ID List.....	A-6
Advanced receiving operations.....	A-7
Operation from extension telephones.....	A-7
Fax/Tel mode when power key is On	A-7
Fax/Tel mode when power key is Off	A-7
Using a cordless external handset.....	A-8
Changing the remote codes.....	A-8
Connecting an external device to your MFC.....	A-9
Connecting an external telephone.....	A-9
Connecting an external telephone answering device (TAD).....	A-10
Sequence	A-10
Connections.....	A-12
Recording outgoing message (OGM) on an external TAD.....	A-12
Special line considerations	A-13
Roll over phone lines	A-13
Two-line phone system.....	A-13
Converting telephone wall outlets.....	A-14
Installing MFC, external two-line TAD and two-line telephone	A-15
Multi-line connections (PBX).....	A-16
If you are installing the MFC to work with a PBX ...	A-16
Custom features on your phone line.....	A-16

B

Appendix B	B-1
On-screen programming.....	B-1
Menu table.....	B-1
Memory storage.....	B-1
Navigation keys	B-2
Entering Text	B-12
Inserting spaces	B-12
Making corrections	B-12
Repeating letters	B-12
Special characters and symbols.....	B-13

G

Glossary	G-1
-----------------------	------------

Specifications	S-1
Product description	S-1
General	S-1
Print media	S-3
Copy	S-4
PhotoCapture Center (MFC-5840CN only)	S-5
Fax.....	S-6
Scanner	S-7
Printer	S-8
Interfaces	S-8
Computer requirements	S-9
Consumable items	S-10
Network (LAN)	S-11
Optional External Wireless Print/Scan Server (NC-2200w)	S-11
Index	I-1
Remote Retrieval Access card	R-1

1 Introduction

Using this Guide

Thank you for buying a Brother Multi-Function Center (MFC). Your MFC is simple to use, with LCD screen instructions to guide you through programming it. You can make the most of your MFC by reading through this Guide.





Finding information

All the chapter headings and subheadings are listed in the Table of Contents. You will be able to find information about a specific feature or operation by checking the Index at the back of this Guide.

Symbols used in this Guide

Throughout this Guide you will see special symbols alerting you to important warnings, notes and actions. To make things clearer and to help you press the correct keys, we used special fonts and added some of the messages that will appear in the LCD.

- | | |
|--------------------------|---|
| Bold | Bold typeface identifies specific keys on the MFC control panel. |
| <i>Italics</i> | Italicized typeface emphasizes an important point or refers you to a related topic. |
| <code>Courier New</code> | Courier New type face identifies the messages on the LCD of the MFC. |

-  Warnings inform you what to do to avoid possible personal injury.
-  Cautions specify procedures you must follow or avoid to prevent possible damage to the MFC.
-  Notes tell you how you should respond to a situation that may arise or give tips about how the current operation works with other features.
-  Improper Setup alerts you to devices and operations that are not compatible with the MFC.

Control panel overview

MFC-5440CN

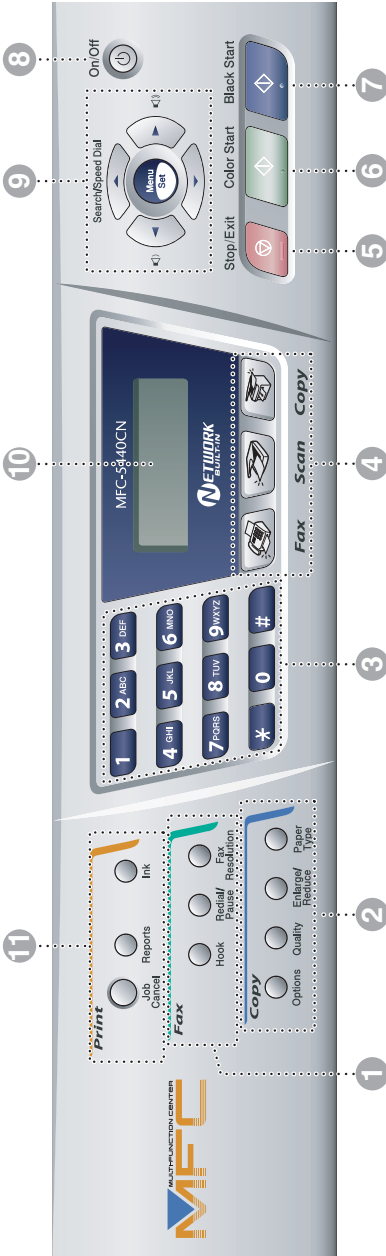

MFC-5840CN

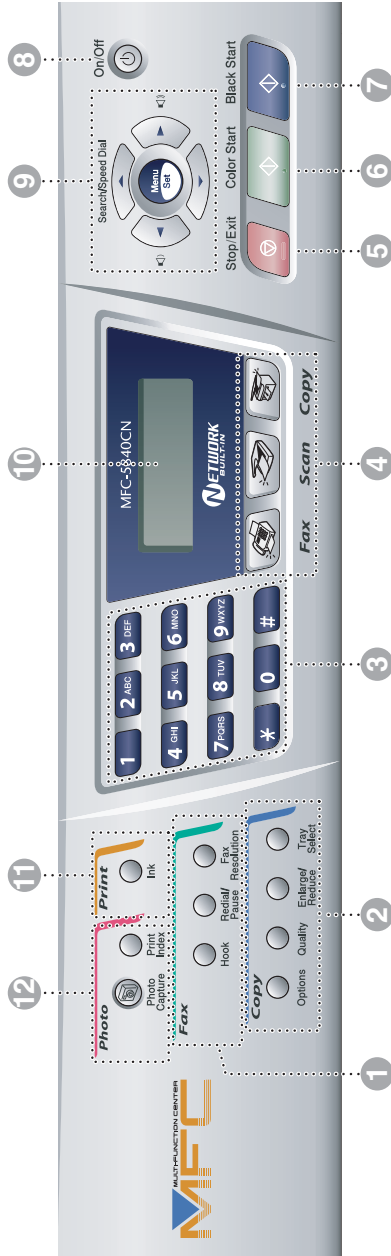

1 Fax and Telephone keys:

Hook

Press before dialing if you want to make sure a fax machine will answer, and then press **Black Start** or **Color Start**.

Redial/Pause

Redials the last number you called. It also inserts a pause in quick dial numbers.

Fax Resolution

Sets the resolution when you send a fax.

2 Copy keys (Temporary settings):

Options

You can quickly and easily select temporary settings for copying.

Quality

Use this key for temporary copy settings.

Enlarge/Reduce

Lets you enlarge or reduce copies depending on the ratio you select.

Paper Type (MFC-5440CN only)

You can select which type of paper you want to use for the next copy.

Tray Select (MFC-5840CN only)

You can select which tray you want to use for the next copy.

3 Dial Pad

Use these keys to dial telephone or fax numbers and as a keyboard for entering information into the MFC.

The # key lets you temporarily switch the dialing mode during a telephone call from Pulse to Tone.

4 Mode keys:



Fax

Lets you access Fax mode.



Scan

Lets you access Scan mode.



Copy

Lets you access Copy mode.

5 Stop/Exit



Stop/Exit

Stops an operation or exits from the menu.

6 Color Start



Color Start

Lets you start sending faxes or making copies in full color.

Also lets you start a scanning operation (in color or black, depending on the scanning setting on your PC).

7 Black Start



Black Start

Lets you start sending faxes or making copies in black and white.

Also lets you start a scanning operation (in color or black, depending on the scanning setting on your PC).

8 On/Off

You can turn the MFC on or off. Also, you can set the On/Off Setting so the MFC can still receive faxes when it is turned off.

9 Navigation keys:

Menu/Set

The same key is used for Menu and Set operations.

Lets you access the Menu to program and store your settings in the MFC.



When using the one-way speaker or during ringing in fax mode, you can press these keys to adjust the volume.

▲ Search/Speed Dial

Lets you look up numbers that are stored in the dialing memory. It also lets you dial stored numbers by pressing # and a two-digit number.



Press to scroll backward to a menu selection.



Press to scroll through the menus and options.

10 Liquid Crystal Display (LCD)

Displays messages on the screen to help you set up and use your MFC.

11 Print keys:

Job Cancel (MFC-5440CN only)

Clears data from the printer memory.

Reports (MFC-5440CN only)

Lets you print lists of information about your MFC.

Ink

Lets you clean the print head, check the print quality, and check the available ink volume.

12 Photo keys: (MFC-5840CN only)

PhotoCapture

Lets you access the PhotoCapture Center™ mode.

Print Index

You can quickly and easily print the index with thumbnail images from your media card.

Turning the MFC on and off

When the machine is idle, you can turn it on and off by pressing the **On/Off** key. In Off mode, no MFC operations will be available. Even if you turned the MFC off, it will periodically clean the print head to preserve print quality.

Turning the MFC off

Press and hold down the **On/Off** key until the LCD shows:

Shutting Down

The LCD light will go off.

Turning the MFC on

Press and hold down the **On/Off** key until the LCD shows:

Please Wait

The LCD will show the date and time (Fax mode).



Even in Off mode, you can receive fax and telephone calls by customizing the **On/Off** key as explained next page. (See *On/Off Setting* on page 1-6.)



If you have connected an external telephone or TAD, it is always available.

On/Off Setting

You can customize the MFC's **On/Off** key. The default setting is `Fax Receive:Off`. Your MFC will not work when it is switched **Off**, but it will purge the ink head periodically. If you turn this setting to **On**, you can receive faxes or calls even when the MFC is switched **Off**. (See *Turning the MFC on and off* on page 1-5.)

- 1 Press **Menu/Set**, **1**, **6**.
- 2 Press **▲** or **▼** to select **On** (or **Off**).
- 3 Press **Menu/Set**.
- 4 Press **Stop/Exit**.

General Setup
6.On/Off Setting

On/Off Setting	Receive Mode	Available Operations
Fax Receive:Off (default)	—	No machine operations will be available.
Fax Receive:On	Fax Only External TAD	Fax Receive, Easy Receive, Delayed Fax, Remote Fax Options, Remote Retrieval. <ul style="list-style-type: none"> ■ You cannot receive a fax with Black Start or Color Start. ■ Delayed Fax and Remote Fax Options should be set before you switch off the machine.
	Manual Fax/Tel*	Delayed Fax, Easy Receive <ul style="list-style-type: none"> ■ You cannot receive a fax with Black Start or Color Start. ■ * You cannot receive a fax automatically even if you have set the receive mode to <code>Fax/Tel</code>. ■ Delayed Fax should be set before you switch off the MFC.



The external telephone or TAD is always available.

Load documents

You can send a fax, make copies, and scan from the ADF (automatic document feeder) and from the scanner glass.

Using the automatic document feeder (ADF)

The ADF can hold up to 35 pages and feeds each sheet individually. Use standard (20 lb) paper and always fan the pages before putting them in the ADF.

Recommended environment

Temperature: 68°F - 86°F (20°C - 30°C)

Humidity: 50% - 70%

Paper: 20 lb LTR

-  DO NOT use paper that is curled, wrinkled, folded, ripped, stapled, paper clipped, pasted or taped.
DO NOT use cardboard, newspaper or fabric. (To fax, copy or scan this kind of document, see *Using the scanner glass* on page 1-9.)
- Make sure documents written with ink are completely dry.
- Documents to be faxed must be from 5.8 to 8.5 inches wide and 5.8 to 14 inches long.

1 Unfold the ADF Document Support.

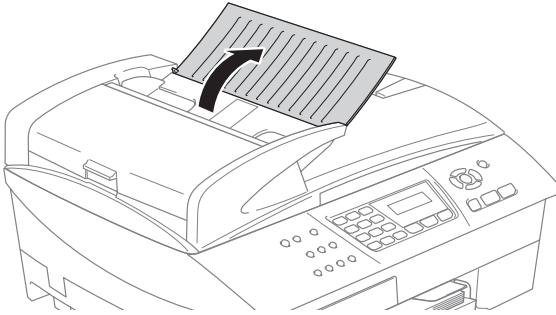

2 Fan the pages well and stagger them at an angle. Make sure you put the originals **face up, top edge first** in the ADF until you feel them touch the feed roller.

3 Adjust the paper guides to fit the width of your documents.

4 Unfold the ADF Document Output Support Flap.

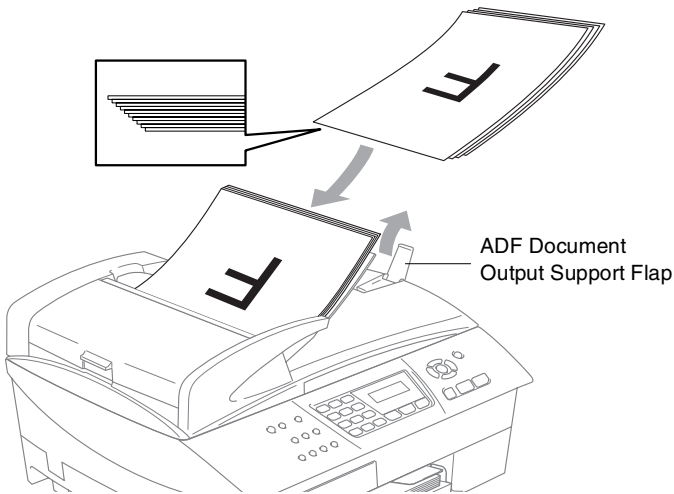

! **DO NOT** pull on the document while it is feeding.

! To use the ADF, the scanner glass must be empty.

Using the scanner glass

You can use the scanner glass to fax pages of a book or one page at a time. Documents can be up to letter size (8.5 inches to 11 inches).



To use the scanner glass, the ADF must be empty.

- 1** Lift the document cover.

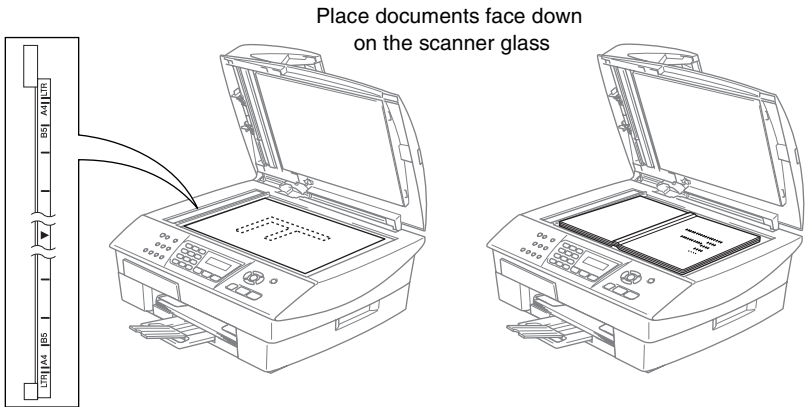

- 2** Using the document guidelines on the left, center the document face down on the scanner glass.
- 3** Close the document cover.



If the document is a book or is thick, do not slam the cover or press on it.

About paper

The print quality can be affected by the type of paper you use in the MFC.

To get the best print quality for the settings you've chosen, always set the Paper Type to match the type of paper you load.

You can use plain paper, inkjet paper (coated paper), glossy paper, transparencies and envelopes.

We recommend testing various paper types before purchasing large quantities.

For best results, use the recommended paper.



- When you print on inkjet paper (coated paper), transparencies and glossy paper, be sure to select the proper media in the “Basic” tab of the printer driver or in the Paper Type setting of the menu (**Menu/Set, 1, 2**).
- When you print on Brother glossy paper, load the instruction sheet included with the glossy paper in the paper tray first, and then place the glossy paper on the instruction sheet.
- When you use transparencies or glossy paper, remove each sheet immediately to prevent smudging or paper jams.
- Avoid touching the printed surface of the paper immediately after printing; the surface may not be completely dry and may stain your fingers.

Recommended Paper

To get the best print quality, we suggest using Brother paper. (See table below.)

We recommend using “3M Transparency Film” when you print on transparencies.

Brother Paper

Paper Type	Item
Letter Plain	BP60PL
Letter Glossy	BP60GLL
Letter Inkjet (Photo Matte)	BP60ML

Handling and using special paper

- Store paper in its original packaging, and keep it sealed. Keep the paper flat and away from moisture, direct sunlight and heat.
- The coated side of glossy paper is shiny. Avoid touching the shiny (coated) side. Load glossy paper with the shiny side facing down.
- Avoid touching either side of transparencies, because they absorb water and perspiration easily, and this may cause decreased output quality. Transparencies designed for laser printers/copiers may stain your next document. Use only transparencies recommended for inkjet printing.



Do not use paper:

- that are damaged, curled, wrinkled, or irregularly shaped

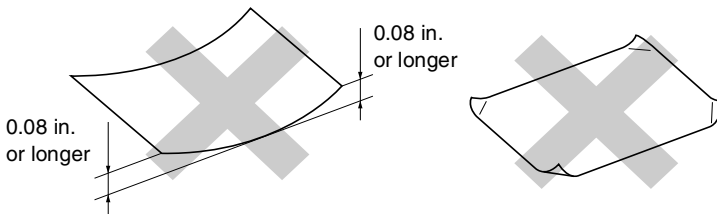

- that are extremely shiny or highly textured
- that were previously printed by a printer
- that cannot be arranged uniformly when stacked
- that are made with a short grain

Paper type and size for each operation

Paper Type	Paper Size	Usage			
		Fax	Copy	PhotoCapture (MFC-5840CN only)	Printer
Cut Paper	Letter	Yes*	Yes*	Yes	Yes*
	A4	Yes*	Yes*	Yes	Yes*
	Legal	Yes*	Yes*	-	Yes*
	Executive	-	-	-	Yes*
	JIS B5	-	-	-	Yes*
	A5	-	Yes	-	Yes
A6	-	-	-	Yes	
Cards	Photo	-	Yes	Yes	Yes
	Photo L	-	-	-	Yes
	Photo 2L	-	-	Yes	Yes
	Index Card	-	-	-	Yes
	Post Card 1	-	-	-	Yes
	Post Card 2 (Double)	-	-	-	Yes
Envelopes	C5 Envelope	-	-	-	Yes
	DL Envelope	-	-	-	Yes
	COM-10	-	-	-	Yes
	Monarch	-	-	-	Yes
	JE4 Envelope	-	-	-	Yes
Transparencies	Letter	-	Yes	-	Yes
	A4	-	Yes	-	Yes

*Tray#2 is also available. (MFC-5840CN only)

Paper weight, thickness and capacity

Paper Type		Weight	Thickness	No. of sheets
Cut Paper	Plain Paper	17 to 32 lb (64 to 120 g/m ²)	0.003" to 0.006" (0.08 to 0.15 mm)	100* ¹ * ² 250* ³ (Tray#2) (MFC-5840CN)
	Inkjet Paper	17 to 53 lb (64 to 200 g/m ²)	0.003" to 0.01" (0.08 to 0.25 mm)	20
	Glossy Paper	Up to 58 lb (Up to 220 g/m ²)	Up to 0.01" (Up to 0.25 mm)	20
Cards	Photo Card	Up to 64 lb (Up to 240 g/m ²)	Up to 0.01" (Up to 0.28 mm)	20
	Index Card	Up to 32 lb (Up to 120 g/m ²)	Up to 0.006" (Up to 0.15 mm)	30
	Post Card	Up to 53 lb (Up to 200 g/m ²)	Up to 0.01" (Up to 0.23 mm)	30
Envelopes		20 to 25 lb (75 to 95 g/m ²)	Up to 0.02" (Up to 0.52 mm)	10
Transparencies		-	-	10

*¹ Up to 50 sheets for Legal size paper (20 lb).

*² Up to 100 sheets of 20 lb.

*³ Up to 250 sheets of 20 lb.

Paper capacity of the output paper tray

Output Paper Tray	<p>Up to 50 sheets of 20 lb (Letter)</p> <ul style="list-style-type: none"> ■ Transparencies or glossy paper must be picked up from the output paper tray one page at a time to avoid smudging. ■ Legal paper cannot be stacked on the output paper tray.
-------------------	---

Printable area

The printable area depends on the settings in the application you are using. The figures below show the unprintable areas on cut sheet paper and envelopes.

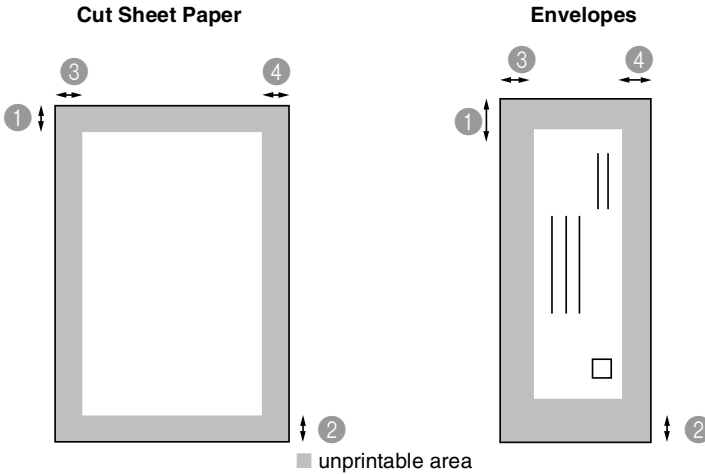

	① Top	② Bottom	③ Left	④ Right
Cut Sheet	0.12 in. (0 in.)* ¹	0.12 in. (0 in.)* ¹	0.12 in. (0 in.)* ¹	0.12 in. (0 in.)* ¹
Envelopes	0.47 in.	0.94 in.	0.12 in.	0.12 in.



*1 When you set the Borderless feature to On.

- Printable area depends on the Printer driver settings.
- The figures above are approximate and the printable area may vary depending on the type of cut sheet paper you are using.
- (MFC-5840CN only)
You can use the borderless feature with Tray#1 only.

How to load paper, envelopes and post cards

 For Tray#2, see *To load paper in paper tray#2 (MFC-5840CN only)* on page 1-17.

To load paper or other media

- 1** Pull the paper tray completely out of the MFC and remove the output paper tray.

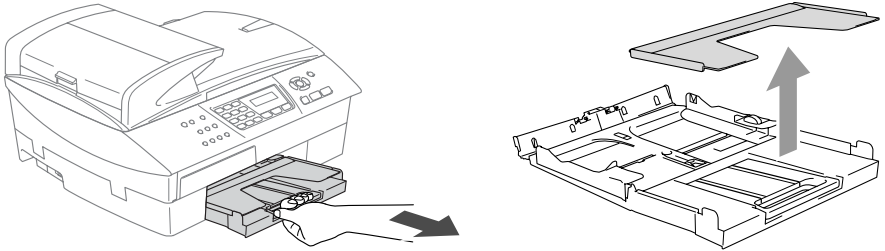

- 2** Press and slide the paper side guide to fit the paper width.

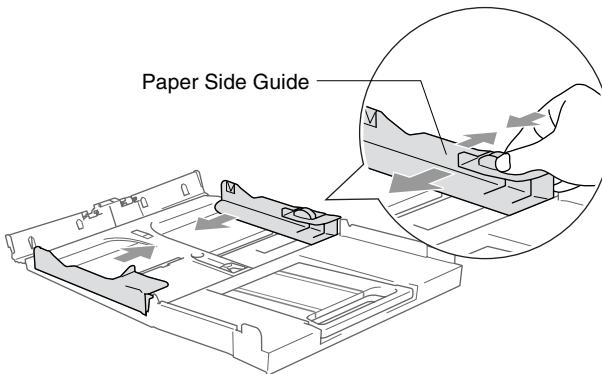

- 3** Pull out the paper support and unfold the paper support flap.

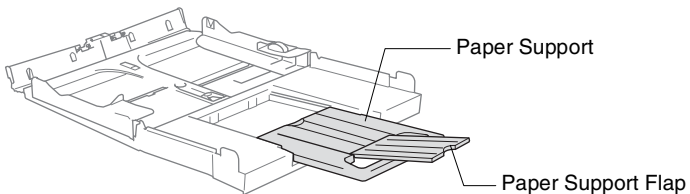

 Use the paper support flap for Letter, Legal and A4.

- 4** Fan the stack of paper well to avoid paper jams and mis-feeds.

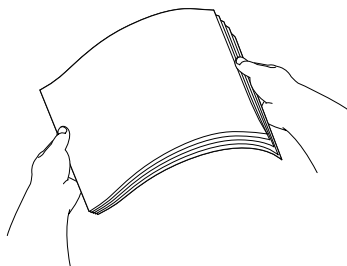

- 5** Gently insert the paper into the paper tray print side face down and the leading edge (top of the paper) in first.
Check that the paper is flat in the tray and below the maximum paper mark.

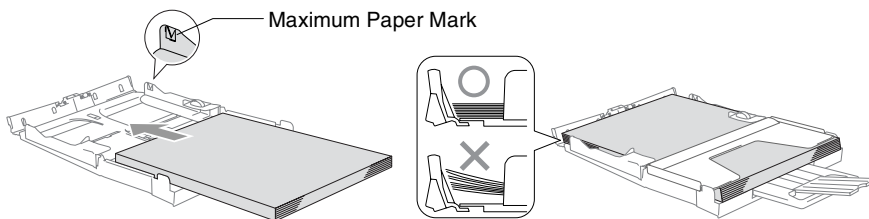

- Make sure the paper side guides touch the sides of the paper.
- Be careful that you do not push the paper in too far; it may lift at the back of the tray and cause feed problems.

- 6** Put the output paper tray back on and push the paper tray firmly back into the MFC.

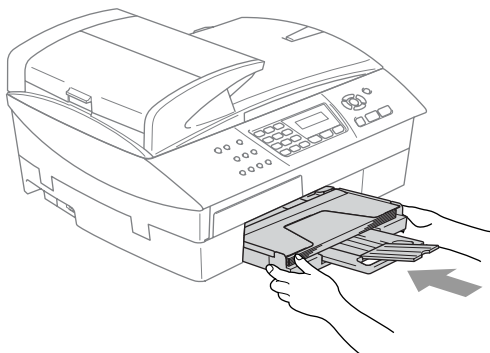

To load paper in paper tray#2 (MFC-5840CN only)

 You can use only plain paper sizes Letter, Legal, A4, Executive or B5 in Tray#2.

1 Pull the paper tray completely out of the MFC.

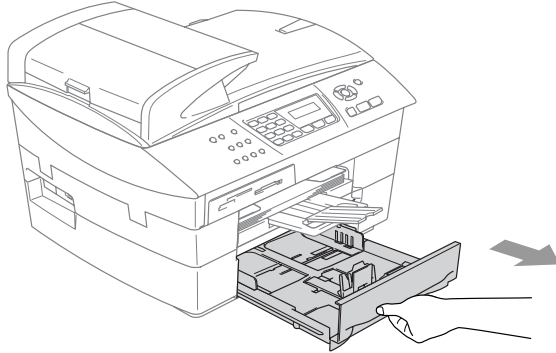

2 Press and slide the paper side guide and paper length guide to fit the paper width and length.

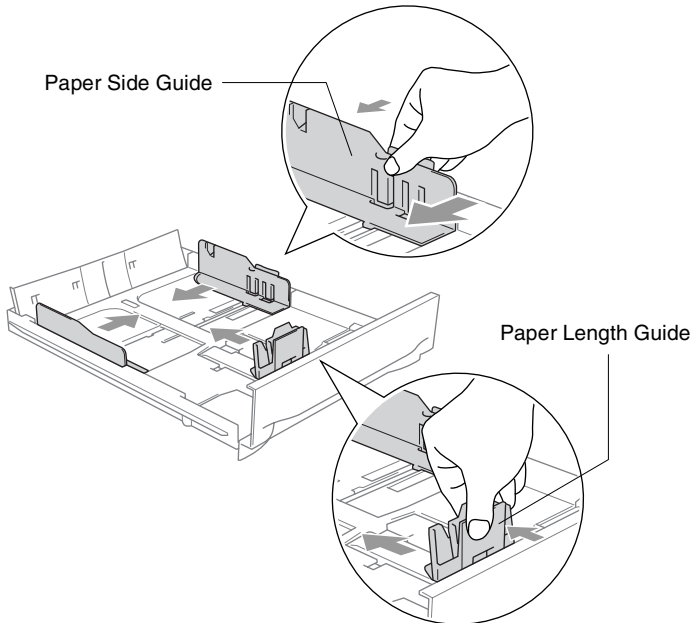



When you use Legal size paper, open the tray cover, and then press and hold the universal guide release button as you slide out the front of the paper tray.

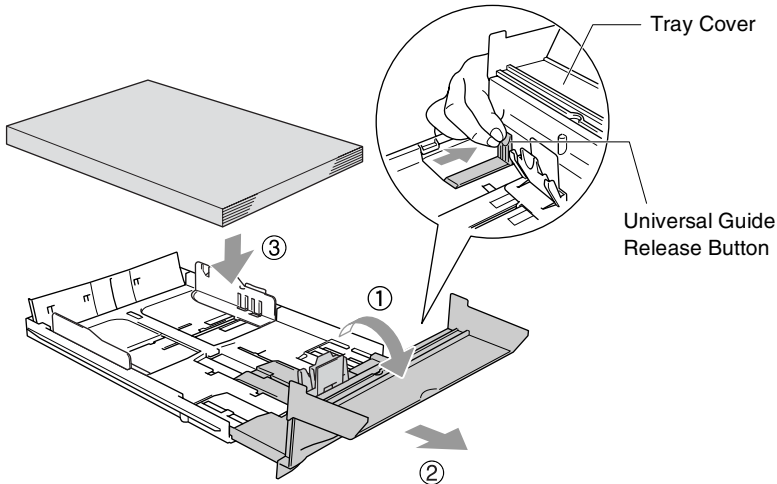

3 Fan the stack of paper well to avoid paper jams and mis-feeds.

4 Gently insert the paper into the paper tray print side face down and the leading edge (top of the paper) in first.

Check that the paper is flat in the tray and below the maximum paper mark.

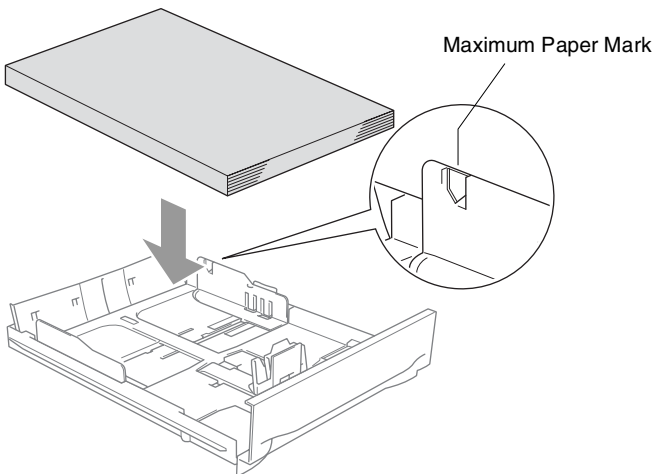

Make sure the paper side guides and paper length guide touch the sides of the paper.

5 Put the paper tray firmly back into the MFC.

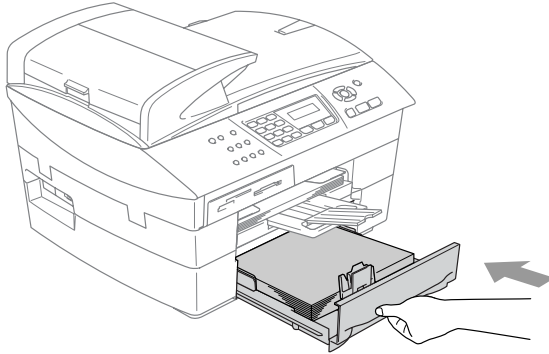

 For Legal size paper, close the tray cover and put the paper tray firmly back into the MFC.

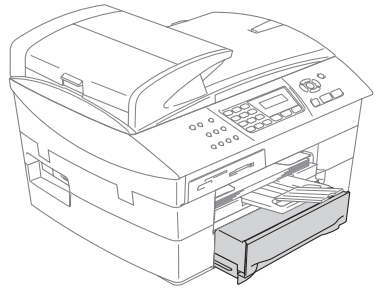
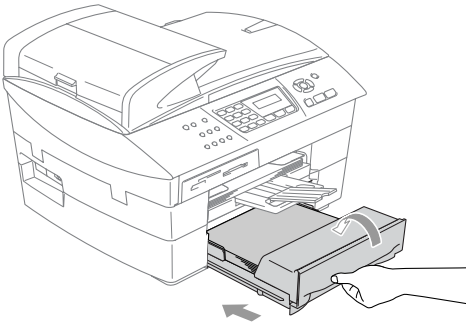

To load envelopes

- Use envelopes that weigh from 20 to 25 lb.
- Some envelopes require margin settings in the application. Make sure you do a test print first.
- ⊘ To prevent possible damage to the feeding mechanism, do not use the types of envelopes shown below.

DO NOT USE ENVELOPES:

- that are of a baggy construction
- that are embossed (have raised writing on them)
- that have clasps on them
- that are not sharply creased
- that are preprinted on the inside

■ Glue

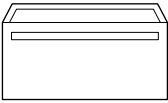

■ Rounded flap

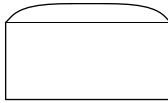

■ Double flap

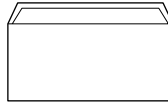

■ Triangular flap

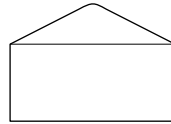

How to load envelopes

- 1 Before loading, press the corners and sides of the envelopes to make them as flat as possible.

-  If the envelopes are 'double-feeding,' put one envelope in the paper tray at a time.

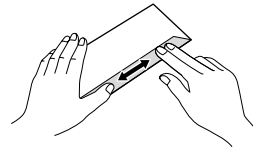
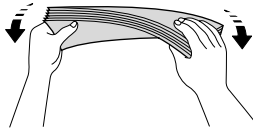
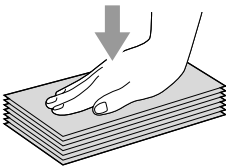

- 2 Insert the envelopes into the paper tray with the address side down and the leading edge (top of the envelopes) in first. Slide the paper side guide to fit the width of the envelopes.

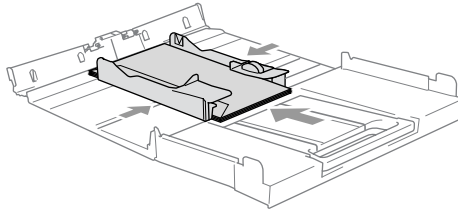

If you have problems when printing on envelopes, try the following suggestions:

- 1 Open the envelope flap.
- 2 Make sure the open flap is either to the side of the envelope or to the back edge of the envelope when printing.
- 3 Adjust the size and margin in your application.

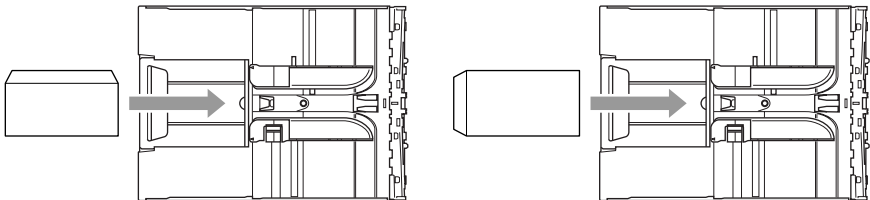

To load post cards

- 1 Raise the paper stop and insert the post cards into the paper tray. Slide the paper side guide to fit the width of the post cards.

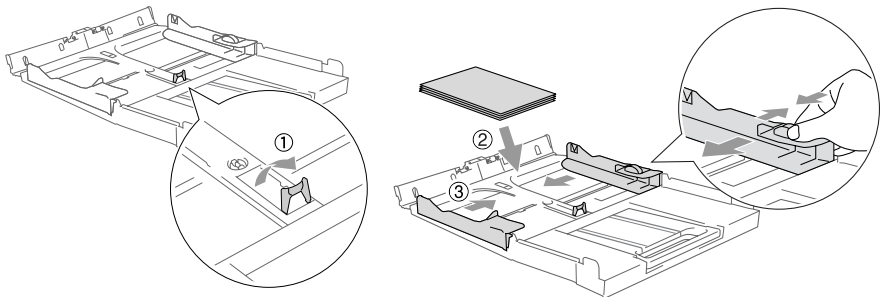

About fax machines

Custom features

Do you have Voice Mail on the phone line?

If you have Voice Mail on the phone line where you will install your new MFC, *there is a strong possibility that Voice Mail and the MFC may conflict with each other while receiving incoming calls.*

Why should there be problems?

Since both the MFC and Voice Mail will pick up the call, after the number of rings you have set, each of them has the ability to keep the other from receiving calls.

For example, if your Voice Mail is set to answer after two rings and your MFC is set to answer after four, your Voice Mail will stop your MFC from receiving faxes.

If you set Voice Mail and the Brother MFC to answer after the same number of rings, there is no way of knowing which one will answer first. It is important to remember that neither Voice Mail nor the MFC can pass the call back to the other after the call has been answered.

How can you avoid possible problems?

A very good way to avoid problems like the one mentioned, *is to get a second phone number on your present phone line.*

Many people with Voice Mail choose an alternative service, which is called “Distinctive Ring”, and they are very satisfied with it. (See *Distinctive Ring* on page A-1.)

Another way to avoid possible problems is to replace your Voice Mail with an answering machine. Your Brother MFC is designed to work with an answering machine or TAD (telephone answering device). (See *Connecting an external telephone answering device (TAD)* on page A-10.)

Fax tones and handshake

When someone is sending a fax, the MFC sends fax calling tones (CNG tones). These are quiet, intermittent beeps every 4-seconds. You'll hear them after you dial and press **Black Start** or **Color Start** and they will continue for about 60 seconds after dialing. During that time, the sending machine must begin the "handshake", or connection, with the receiving machine.

Each time you use automatic procedures to send a fax, you are sending CNG tones over the phone line. You will soon learn to listen for these quiet beeps each time you answer a phone on your fax line, so you will know if you are receiving a fax message.

The receiving fax responds with fax receiving tones, which are loud, chirping sounds. A receiving fax chirps for about 40 seconds over the phone line, and the LCD shows *Receiving*.

If your MFC is set to the Fax Only mode, it will answer every call automatically with fax receiving tones. If the other person hangs up, your MFC will continue to send the "chirps" for about 40 seconds, and the LCD continues to show *Receiving*. To cancel receiving, press **Stop/Exit**.

The fax 'handshake' is the time in which the sending machine's CNG tones and the receiving machine's "chirps" overlap. This must be for at least 2 to 4 seconds, so both machines can understand how each is sending and receiving the fax. The handshake cannot begin until the call is answered, and the CNG tones only last for about 60 seconds after the number is dialed. So it is important for the receiving machine to answer the call in as few rings as possible.



When you have an external Telephone Answering Device (TAD) on your fax line, your TAD will decide the number of rings before the call is answered.

ECM (Error Correction Mode)

The Error Correction Mode (ECM) is a way for the MFC to check a fax transmission while it is in progress. If the MFC detects errors during fax transmission, it resends the pages of the fax that had an error. ECM transmissions are only possible between fax machines that both have this feature. If they do, you may send and receive fax messages that are continuously being checked by the MFC.

Your MFC must have enough memory for this feature to work.

2

Getting started

Initial Setup

Setting the Date and Time

When the MFC is not in use it will display the date and time. If you set up the Station ID the date and time displayed by your MFC will be printed on every fax you send. If there is a power failure, you may have to reset the date and time. No other settings will be affected.

1 Press **Menu/Set, 0, 2.**

2 Enter the last two digits of the year.

Initial Setup
2.Date/Time

Press **Menu/Set.**

3 Enter two digits for the month.

Press **Menu/Set.**

(For example, enter 09 for September, or 10 for October.)

4 Enter two digits for the day.

Press **Menu/Set.** (For example, enter 06 for 6th.)

5 Enter the time in 24-Hour format.

Press **Menu/Set.** (For example, enter 15:25 for 3:25 P.M.)

6 Press **Stop/Exit.**

The LCD now shows the date and time whenever the MFC is in Fax mode.

Setting Tone and Pulse dialing mode

1 Press **Menu/Set, 0, 4.**

2 Press **▲** or **▼** to select **Pulse** (or **Tone**).

Initial Setup
4.Tone/Pulse

Press **Menu/Set.**

3 Press **Stop/Exit.**

Setting the Station ID

You should store your name or company name and fax number so they print on all fax pages you send.

- 1 Press **Menu/Set**, **0**, **3**.
- 2 Enter your fax number (up to 20 digits).

Initial Setup 3.Station ID

Press **Menu/Set**.



You cannot enter a hyphen in the fax number. To enter a space press **▶** once between numbers.

- 3 Use the dial pad to enter your name (up to 20 characters). (See *Entering Text* on page B-12.)

Press **Menu/Set**.

- 4 Press **Stop/Exit**.



If the Station ID has already been programmed, the LCD will ask you to press **1** to make a change or **2** to exit without changing.

NOTICE (For USA)

The Telephone Consumer Protection Act of 1991 makes it unlawful for any person to use a computer or electronic device to send any message via a telephone fax machine unless such messages clearly contain, in a margin at the top or bottom of each transmitted page, or on the first page of the transmission, the date and time it is sent and an identification of the business or other entity or other individual sending the message and the telephone number of the sending machines or such business, other entity or individual.

To program this information into your MFC, see *Setting the Date and Time* on page 2-1 and *Setting the Station ID* on page 2-2.

General Setup

Setting the Mode Timer

The MFC has three temporary mode keys on the control panel: Fax, Scan and Copy. The PhotoCapture key (MFC-5840CN only) is also a temporary mode key. You can change the number of seconds or minutes that the MFC takes after the last Scan, Copy or PhotoCapture operation before it returns to Fax mode. If you select *Off*, the MFC stays in the mode you used last.



- 1 Press **Menu/Set**, **1**, **1**.
- 2 Press **▲** or **▼** to select 0 Sec, 30 Secs, 1 Min, 2 Mins, 5 Mins or *Off*.
Press **Menu/Set**.
- 3 Press **Stop/Exit**.

General Setup
1.Mode Timer

Setting the Paper Type

To get the best print quality, set the MFC for the type of paper you are using.

- 1 Press **Menu/Set**, **1**, **2**.
- 2 Press **▲** or **▼** to select *Plain*, *Inkjet*, *Glossy* or *Transparency*.
Press **Menu/Set**.
- 3 Press **Stop/Exit**.

General Setup
2.Paper Type

-  ■ The MFC ejects paper with printed surfaces face up onto the paper tray in the front of the machine. When you use transparencies or glossy paper, remove each sheet immediately to prevent smudging or paper jams.
- (MFC-5840CN only)
You can only use plain paper in Tray#2.

Setting the Paper Size

You can use five sizes of paper for printing copies: Letter, Legal, A4, A5, and 4" x 6" and three sizes for printing faxes: Letter, Legal and A4. When you change the type of paper you load in the MFC, you will need to change the setting for Paper Size at the same time so your MFC can fit an incoming fax on the page.

1 Press **Menu/Set, 1, 3.**

General Setup
3.Paper Size

2 (MFC-5840CN only)

Press **▲** or **▼** to select Tray#1 or
Tray#2.

Press **Menu/Set.**

3 Press **▲** or **▼** to select Letter, Legal, A4, A5 or 4"x6".

Press **Menu/Set.**

4 Press **Stop/Exit.**



(MFC-5840CN only)

You can only use plain paper sizes Letter, Legal or A4 in Tray#2.

Setting the Ring Volume

You can turn the ring **Off** or you can select the ring volume level.

1 Press **Menu/Set, 1, 4, 1.**



2 Press **▲** or **▼** to select
Low, Med, High or Off.

Press **Menu/Set.**

3 Press **Stop/Exit.**

Volume 1.Ring

—OR—

You can adjust the ring volume when your MFC is idle (not being used). In Fax mode , press  or  to adjust the volume level. Every time you press these keys, the MFC will ring so you can hear the active setting as the LCD shows it. The volume changes with each key press. The new setting will stay until you change it again.

Setting the Beeper Volume

You can change the beeper volume. The default (factory) setting is **Low**. When the beeper is on, the MFC will beep when you press a key, make a mistake and whenever you send or received a fax.

1 Press **Menu/Set, 1, 4, 2.**

2 Press **▲** or **▼** to select your option.
(Low, Med, High or Off)

Press **Menu/Set.**

3 Press **Stop/Exit.**

Volume 2.Beeper

Setting the Speaker Volume

You can adjust the MFC's one-way speaker volume.

1 Press **Menu/Set, 1, 4, 3.**

2 Press **▲** or **▼** to select

Low, Med, High or Off.



Press **Menu/Set.**

3 Press **Stop/Exit.**

Volume 3.Speaker

—OR—

In Fax mode , you can adjust the speaker volume by pressing **Hook**, and then selecting a speaker volume level.

Press  or  to adjust the volume level. The LCD shows the setting you are choosing. Each key press changes the volume to the next setting. The new setting will remain until you change it again.

Turning on Automatic Daylight Savings Time

You can set the MFC to change automatically for Daylight Savings Time. It will reset itself forward one hour in the Spring and backward one hour in the Fall. Make sure you have set the correct day and time in the **Date/Time** setting.

1 Press **Menu/Set, 1, 5.**

2 Press **▲** or **▼** to select **On** (or **Off**).

Press **Menu/Set.**

3 Press **Stop/Exit.**

General Setup 5.Auto Daylight

Setting the LCD Contrast

You can adjust the LCD contrast for a sharper and more vivid display. If you are having difficulty reading the LCD from your position, try changing the contrast setting for improved viewing.

- 1 Press **Menu/Set**, **1**, **7**.
- 2 Press **▲** or **▼** to select `Light` or `Dark`.
Press **Menu/Set**.
- 3 Press **Stop/Exit**.

General Setup
7.LCD Contrast

Setting the Tray Use for Copy mode (MFC-5840CN only)

The MFC uses the paper in Tray#1 first. You can change the default tray that will be used for copying.

- 1 Press **Menu/Set**, **1**, **8**.
- 2 Press **▲** or **▼** to select `Tray#1 Only`, `Tray#2 Only`, or `Auto Select`.
Press **Menu/Set**.
- 3 Press **Stop/Exit**.

General Setup
8.Tray Use:Copy



- If both trays are using paper that is the same type and size, `Auto Select` will allow your MFC to take paper from Tray#2 if Tray#1 is out of paper.
- You can only use plain paper sizes Letter, Legal or A4 in Tray#2.

Setting the Tray Use for Fax mode (MFC-5840CN only)

The MFC uses the paper in Tray#1 first. You can change the default tray that will be used for printing received faxes.

1 Press **Menu/Set, 1, 9**.

2 Press **▲** or **▼** to select **Tray#1 Only**,
Tray#2 Only, or **Auto Select**.

General Setup 9.Tray Use:Fax

Press **Menu/Set**.

3 Press **Stop/Exit**.





■ **Auto Select** will allow your MFC to take paper from **Tray#2**:

- If **Tray#1** is out of paper.
- When it is set up with a different paper size that is more suitable for the received faxes.
- When both trays are using the same size paper and **Tray#1** is not set to use plain paper.

■ You can only use plain paper sizes **Letter**, **Legal** or **A4** in **Tray#2**.

3 Setup Send

How to enter Fax mode

Before sending faxes, make sure  (**Fax**) is illuminated in green. If not, press  (**Fax**) to enter Fax mode. The default setting is Fax.

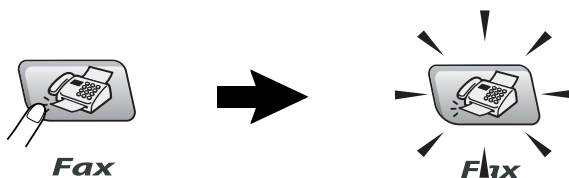

How to dial

You can dial in any of the following ways.

Manual dialing

Press all of the digits of the phone or fax number.



Speed-Dialing

Press **Search/Speed Dial**, **#**, and then the two digit Speed-Dial number. (See *Storing Speed-Dial numbers* on page 5-1.)

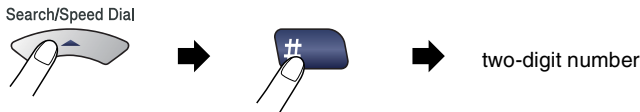

 If the LCD shows `Not Registered` when you enter the Speed-Dial number, a number has not been stored for it.

Search

You can search for names you have stored in the Speed-Dial memories. Press **Search/Speed Dial** and the navigation keys to search. (See *Storing Speed-Dial numbers* on page 5-1.)

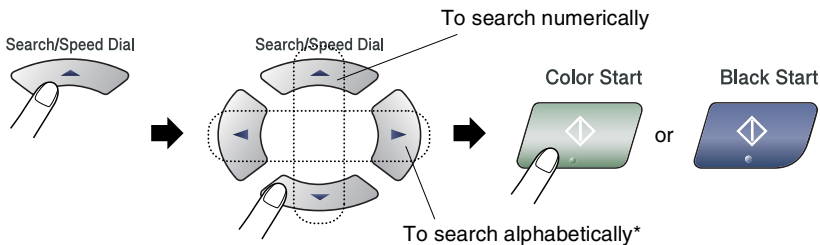

* To search alphabetically, you can use the dial pad to enter the first letter of the name you are looking for.

Fax Redial

If you are sending a fax manually and the line is busy, press **Redial/Pause**, and then press **Black Start** or **Color Start** to try again. If you want to make a second call to the last number dialed, you can save time by pressing **Redial/Pause** and **Black Start** or **Color Start**.

Redial/Pause only works if you dialed from the control panel.

If you are sending a fax automatically and the line is busy, the MFC will automatically redial one time after five minutes.

How to Fax (B&W and Color)

Color fax transmission

Your MFC can send a color fax to machines that support this feature. However, color faxes cannot be stored in the memory. When you send a color fax, the MFC will send it in real time (even if *Real Time TX* is set to *Off*).



Delayed fax and Polling Transmit features are not available in color.

Faxing from the ADF

Put the document face up in the ADF. To cancel, press **Stop/Exit**.

- 1** If it is not illuminated in green, press  (**Fax**).
- 2** Load your document.
- 3** Dial the fax number.

Press **Black Start** or **Color Start**. The MFC starts scanning the first page.



If the memory is full and you are faxing a single page, it will be sent in real time.

Faxing from the scanner glass

You can use the scanner glass to fax pages of a book or one page at a time. The documents can be up to letter size. To cancel, press **Stop/Exit**.

1 If it is not illuminated in green, press  (**Fax**).

2 Load your document on the scanner glass.

3 Dial the fax number.

Press **Black Start** or **Color Start**.

■ If you press **Black Start**, the machine starts scanning the first page.

■ If you press **Color Start**, the machine starts sending.

4 To send a single page, press **2** (or press **Black Start** again).

Next Page?
1.Yes 2.No(Dial)

The MFC starts sending the document.

—OR—

To send more than one page, press **1** and go to Step 5.

5 Place the next page on the scanner glass.

Set Next Page
Then Press Set

Press **Menu/Set**.

The MFC starts scanning. (Repeat Steps 4 and 5 for each additional page.)



■ If the memory is full and you are faxing a single page, it will be sent in real time.

■ You cannot send multiple pages for color faxes.

Automatic transmission

This is the easiest way to send a fax.

- ⊘ Do not pick up the handset of the external phone or press **Hook** to listen for a dial tone.
- 1 If it is not illuminated in green, press  (**Fax**).
- 2 Load your document.
- 3 Enter the fax number using the dial pad, Speed-Dial or Search. (See *How to dial* on page 3-1.)
- 4 Press **Black Start** or **Color Start**.

Manual transmission

Manual transmission lets you hear the dialing, ringing and fax-receiving tones while sending a fax.

- 1 If it is not illuminated in green, press  (**Fax**).
- 2 Load your document.
- 3 Pick up the handset of the external phone and listen for a dial tone.
—OR—
Press **Hook** and listen for a dial tone.
- 4 Dial the fax number you want to call.
—OR—
If you pressed **Hook**, dial using the MFC's control panel.
- 5 When you hear the fax tone, press **Black Start** or **Color Start**.
- 6 If you picked up the handset of an external phone, replace it.

Out of Memory message

If you get an **Out of Memory** message while scanning the first page of a fax, press **Stop/Exit** to cancel the fax. If you get an **Out of Memory** message while scanning a subsequent page, you will have the option to press **Black Start** to send the pages scanned so far, or to press **Stop/Exit** to cancel the operation.



If the memory is full and you are faxing a single page, it will be sent in real time.

Basic sending operations

Sending faxes using multiple settings

When you send a fax you can choose any combination of these settings: contrast, resolution, overseas mode, delayed fax timer, polling transmission or real time transmission.

- 1 If it is not illuminated in green, press  **(Fax)**.

After each setting is accepted, the LCD will ask if you want to enter more settings:

- 2 Press **1** to select more settings. The LCD will return to the `Setup Send` menu.

Other Settings
1.Yes 2.No

—OR—

Press **2** if you have finished choosing settings and go to the next step.

Contrast

If your document is very light or very dark, you may want to change the contrast.

Use `Light` to send a light document.

Use `Dark` to send a dark document.

- 1 If it is not illuminated in green, press  **(Fax)**.

- 2 Load your document.

- 3 Press **Menu/Set, 2, 2, 1**.

- 4 Press **▲** or **▼** to select `Auto, Light` or `Dark`.

Setup Send
1.Contrast

Press **Menu/Set**.

Fax Resolution

You can use the **Fax Resolution** key to change the setting temporarily (for this fax only). In Fax mode , press **Fax Resolution** and ▲ or ▼ to select the setting you want, and then press **Menu/Set**.

—OR—

You can change the default setting:

- 1 If it is not illuminated in green, press  (**Fax**).
- 2 Load your document.
- 3 Press **Menu/Set**, **2**, **2**, **2**.
- 4 Press ▲ or ▼ to select the resolution you want.

Setup Send 2.Fax Resolution

Press **Menu/Set**.

Standard	Suitable for most typed documents.
Fine	Good for small print and transmits a little slower than Standard resolution.
S.Fine	Good for small print or artwork and transmits slower than Fine resolution.
Photo	Use when the document has varying shades of gray or is a photograph. This has the slowest transmission time.

Dual Access (Not available for color faxes)

You can dial a number, and begin scanning the fax into memory—even when the MFC is sending from memory or receiving faxes. The LCD shows the new job number and available memory.



Your MFC normally uses Dual Access. However, to send a color fax, the MFC will send the document in real time (even if `Real Time TX is Off`).

The number of pages you can scan into the memory will vary depending on the data that is printed on them.



If you get an `Out of Memory` message while scanning the first page of a fax, press **Stop/Exit** to cancel scanning. If you get an `Out of Memory` message while scanning a subsequent page, you can press **Black Start** to send the pages scanned so far, or press **Stop/Exit** to cancel the operation.

Real Time Transmission

When you are sending a fax, the MFC will scan the documents into the memory before sending. Then, as soon as the phone line is free, the MFC will start dialing and sending.

If the memory becomes full, the MFC will send the document in real time (even if `Real Time TX` is set to `Off`).

Sometimes, you may want to send an important document immediately, without waiting for memory transmission. You can set `Real Time TX` to `On` for all documents or for the next fax only.

If you want to fax multiple pages from the scanner glass, `Real Time Transmission` should be set to `Off`.

1 If it is not illuminated in green, press  (**Fax**).

2 Load your document.

3 Press **Menu/Set**, **2**, **2**, **5**.

4 To change the default setting, press **▲** or **▼** to select `On` (or `Off`).

Setup Send
5.Real Time TX

Press **Menu/Set**.

—OR—

For the next fax transmission only, press **▲** or **▼** to select `Next Fax Only`.

Press **Menu/Set** and go to Step 5.

5 For the next fax only, press **▲** or **▼** to select `On` (or `Off`).

Press **Menu/Set**.



In `Real Time Transmission`, the redial feature does not work.



If you are sending a color Fax, the MFC will send it in real time (even if `Real Time TX` is set to `Off`).

Checking job status

Check which jobs are still waiting in the memory to be sent. (If there are no jobs, the LCD shows `No Jobs Waiting`.)

- 1** Press **Menu/Set**, **2**, **6**.
- 2** If you have more than one job waiting, press **▲** or **▼** to scroll through the list.
- 3** Press **Stop/Exit**.

Fax 6.Remaining Jobs

Canceling a fax in progress

If you want to cancel a fax, while the MFC is scanning, dialing or sending it, press **Stop/Exit**.

Canceling a scheduled job

You can cancel a fax job that is stored and waiting in the memory.

- 1** Press **Menu/Set**, **2**, **6**.
Any jobs that are waiting will appear on the LCD.
- 2** If you have more than one job waiting, press **▲** or **▼** to select the job you want to cancel.
Press **Menu/Set**.
—OR—
If you only have one job waiting, go to Step 3.
- 3** Press **1** to cancel.
To cancel another job go to Step 2.
—OR—
Press **2** to exit without canceling.
- 4** Press **Stop/Exit**.

Fax 6.Remaining Jobs

Advanced sending operations

Broadcasting (Not available for color faxes)

Broadcasting is when the same fax message is automatically sent to more than one fax number. You can include Groups, Speed-Dial numbers and up to 50 manually dialed numbers in the same broadcast.

Press **Menu/Set** between each of the numbers. Use **Search/Speed Dial** to help you choose the numbers easily. (To set up Group dial numbers, see *Setting up Groups for Broadcasting* on page 5-3.)

After the broadcast is finished, a Broadcast Report will be printed to let you know the results.

- 1 If it is not illuminated in green, press  (**Fax**).
- 2 Load your document.
- 3 Enter a number using Speed-Dial, a Group number, Search or manual dialing using the dial pad.
(Example: Group number)
- 4 When the LCD displays the fax number or name of the other party, press **Menu/Set**.
You will be asked to enter the next number.
- 5 Enter the next number.
(Example: Speed-Dial number)
- 6 When the LCD displays the fax number or name of the other party, press **Menu/Set**.
- 7 After you have entered all fax numbers by repeating Step 5 and 6, go to Step 8 to start the broadcast.
- 8 Press **Black Start**.



- If you did not use up any of the numbers for Groups, access codes or credit card numbers, you can 'broadcast' faxes to as many as 90 (MFC-5440CN) or 150 (MFC-5840CN) different numbers.
- The available memory will vary depending on the types of jobs in the memory and the number of locations used for broadcasting. If you broadcast to the maximum numbers available, you will not be able to use Dual Access and Delayed fax.
- Enter the long dialing sequence numbers as you would normally, but remember that each Speed-Dial number counts as one number, so the number of locations you can store becomes limited.
- If the memory is full, press **Stop/Exit** to stop the job or if more than one page has been scanned, press **Black Start** to send the portion that is in the memory.

Overseas Mode

If you are having difficulty sending a fax overseas due to possible interference on the phone line, we recommend that you turn on the Overseas Mode. After you send a fax using this feature, the feature will turn itself off.

1 If it is not illuminated in green, press  (**Fax**).

2 Load your document.

3 Press **Menu/Set**, **2**, **2**, **7**.

4 Press **▲** or **▼** to select **On** (or **Off**).

Press **Menu/Set**.

Setup Send 7.Overseas Mode

Delayed Fax (Not available for color faxes)

During the day you can store up to 50 faxes in the memory to be sent within 24 hours. These faxes will be sent at the time of day you enter in Step 4.

- 1 If it is not illuminated in green, press  (**Fax**).
- 2 Load your document.
- 3 Press **Menu/Set, 2, 2, 3**.
- 4 Press **Menu/Set** to accept the displayed time.

Setup Send
3.Delayed Fax

—OR—

Enter the time you want the fax to be sent (in 24-hour format).
Press **Menu/Set**.

(For example, enter 19:45 for 7:45 PM.)



The number of pages you can scan into the memory depends on the amount of data that is printed on each page.

Setting up Polled Transmit (Not available for color faxes)

Polled Transmit is when you set up your MFC to wait with a document so another fax machine can call and retrieve it.

- 1 If it is not illuminated in green, press  (**Fax**).
- 2 Load your document.
- 3 Press **Menu/Set, 2, 2, 6**.
- 4 Press **▲** or **▼** to choose On (or Off).
Press **Menu/Set**.

Setup Send
6.Polled TX



The document will be stored and can be retrieved from any other fax machine until you delete the fax in memory by using the Canceling a Job menu setting. (See *Canceling a scheduled job* on page 3-11.)

Delayed Batch Transmission (Not available for color faxes)

Before sending the delayed faxes, your MFC will help you economize by sorting all the faxes in the memory by destination and scheduled time. All delayed faxes that are scheduled to be sent at the same time to the same fax number will be sent as one fax to save transmission time.

- 1 If it is not illuminated in green, press  **(Fax)**.
- 2 Press **Menu/Set, 2, 2, 4**.
- 3 Press **▲** or **▼** to select **On** (or **Off**).
Press **Menu/Set**.
- 4 Press **Stop/Exit**.

Setup Send
4.Batch TX

 The document will be stored and can be retrieved from any other fax machine until you delete the fax in memory by using the Canceling a job menu setting. (See *Canceling a scheduled job* on page 3-11.)

Faxing A4 size documents from the scanner glass

When documents are A4 size, you need to set Scan Glass Size to A4; if you do not, the bottom portion of the faxes will be missing.

- 1 Press **Menu/Set, 2, 2, 0**.
- 2 Press **▲** or **▼** to select **A4** (or **Letter**).
Press **Menu/Set**.
- 3 Press **Stop/Exit**.

4 Setup Receive

Basic receiving operations

Choosing the Receive Mode

There are four different Receive Modes for your MFC. You can choose the mode that best suits your needs.

LCD	How it works	When to use it
Fax Only (automatic receive)	The MFC automatically answers every call as a fax.	For dedicated fax lines.
Fax/Tel (fax and telephone) (with an external or extension telephone)	The MFC controls the line and automatically answers every call. If the call is a fax it will receive the fax. If the call is not a fax it will ring (pseudo/double ring) for you to pick up the call.	Use this mode if you expect to receive lots of fax messages and few telephone calls. You cannot have an answering machine on the same line, even if it is on a separate wall jack on the same line. You cannot use the telephone company's Voice Mail in this mode.
External TAD (with an external answering device only)	The external answering device (TAD) automatically answers every call. Voice messages are stored on the external TAD. Fax messages are printed.	Use this mode if you have connected an answering machine to your MFC. The External TAD setting works only with an external answering machine. Ring Delay does not work in this setting.
Manual (manual receive) (with an external or extension telephone or with Distinctive Ring)	You control the phone line and must answer every call yourself.	Use this mode if you do not receive many fax messages, with Distinctive Ring, or if you are using a computer on the same line. If you answer and hear fax tones, wait until the MFC takes over the call, then hang up. (See <i>Easy Receive</i> on page 4-4.)

To select or change your Receive Mode

- 1 If it is not illuminated in green, press  **(Fax)**.
- 2 Press **Menu/Set, 0, 1**.
- 3 Press **▲** or **▼** to select **Fax Only**, **Fax/Tel**, **External TAD** or **Manual**.
Press **Menu/Set**.
- 4 Press **Stop/Exit**.

Initial Setup
1.Receive Mode

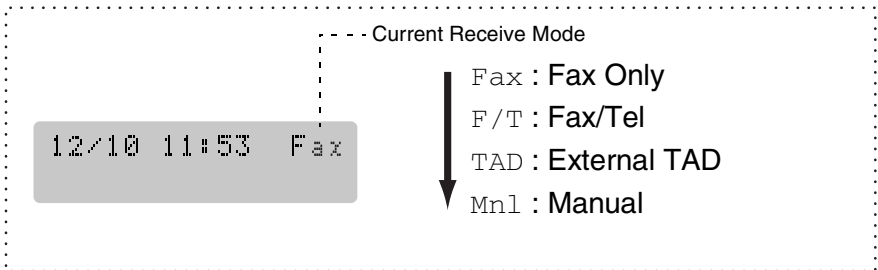

Setting the Ring Delay

The Ring Delay sets the number of times the MFC rings before it answers in **Fax Only** or **Fax/Tel** mode. If you have extension phones on the same line as the MFC or subscribe to the telephone company's Distinctive Ring service, keep the Ring Delay setting of 4. (See *Operation from extension telephones* on page A-7 and *Easy Receive* on page 4-4.)

- 1 If it is not illuminated in green, press  **(Fax)**.
- 2 Press **Menu/Set, 2, 1, 1**.
- 3 Press **▲** or **▼** to select how many times the line rings before the MFC answers (00, 01, 02, 03 or 04).
Press **Menu/Set**.
(If you select 00, the line won't ring at all.)
- 4 Press **Stop/Exit**.

Setup Receive
1.Ring Delay

Setting the F/T Ring Time (Fax/Tel mode only)

If you set the Receive Mode to Fax/Tel, you'll need to decide how long the MFC will signal you with its special pseudo/double-ring when you have a *voice* call. (If it's a fax call, the MFC prints the fax.)

This pseudo/double-ring happens after the initial ringing from the phone company. Only the MFC rings and no other phones on the same line will ring with the special pseudo/double-ring. However, you can still answer the call on any telephone on the same line as the MFC. (See *Fax/Tel mode when power key is On* on page A-7 and *Fax/Tel mode when power key is Off* on page A-7.)

1 If it is not illuminated in green, press  **(Fax)**.

2 Press **Menu/Set, 2, 1, 2**.

3 Press **▲** or **▼** to select how long the MFC will ring to alert you that you have a voice call (20, 30, 40 or 70 seconds).

Press **Menu/Set**.

4 Press **Stop/Exit**.

 Even if the caller hangs up during the pseudo/double-ringing, the MFC will continue to ring for the set time.



Setup Receive
2.F/T Ring Time

Easy Receive

When you use this feature, you don't have to press **Black Start**, **Color Start**, or the Fax Receive Code *51 when you answer a fax call. Selecting **On** allows the MFC to receive fax calls automatically, even if you lift the handset of an extension or external phone. When you see **Receiving** on the LCD or when you hear 'chirps' through the handset of an extension phone connected to another telephone wall jack, just replace the handset and your MFC will do the rest.



- If this feature is set to **On**, but your MFC does not connect a fax call when you lift an extension or external phone handset, press the Fax Receive Code *51.
- If you send faxes from a computer on the same phone line and the MFC intercepts them, set Easy Receive to **Off**.
- Selecting **Off** means you'll have to activate the MFC yourself by lifting the handset of an external or extension phone, and then press **Black Start** or **Color Start** on the MFC

—OR—

by pressing *51 if you are not at your MFC. (See *Operation from extension telephones* on page A-7.)

- 1 If it is not illuminated in green, press  **(Fax)**.
- 2 Press **Menu/Set, 2, 1, 3**.
- 3 Use **▲** or **▼** to select **On** (or **Off**).
Press **Menu/Set**.
- 4 Press **Stop/Exit**.

Setup Receive 3.Easy Receive

Printing a reduced incoming fax (Auto Reduction)

If you choose **On**, the MFC automatically reduces an incoming fax to fit on one page of Letter, Legal or A4 size paper. The MFC calculates the reduction ratio by using the page size of the document and your Paper Size setting (**Menu/Set, 1, 3**).

1 If it is not illuminated in green, press  (**Fax**).

2 Press **Menu/Set, 2, 1, 5**.

3 Use **▲** or **▼** to select **On** (or **Off**).

Setup Receive
5.Auto Reduction

Press **Menu/Set**.

4 Press **Stop/Exit**.



- Turn on this setting if you receive faxes that are split on two pages. However, if the document is too long though, the MFC may print it on two pages.

- If left and right margins are cut off, turn on this setting.

Printing a fax from the memory

If you have selected Fax Forwarding, Paging or Fax Storage (**Menu/Set, 2, 5, 1**), you can still print a fax from the memory when you are at your MFC. (See *Setting Fax Storage* on page 6-3.)

1 Press **Menu/Set, 2, 5, 3**.

2 Press **Black Start**.

Remote Fax Opt
3.Print Fax

Polling

Polling is the process of retrieving faxes from another fax machine. You can use your MFC to 'poll' other machines, or you can have someone poll your MFC.

Everyone who is involved in Polling needs to set up their fax machines for Polling. When someone polls your MFC to receive a fax, they pay for the call. If you poll someone's fax machine to receive a fax, you pay for the call.



Some fax machines do not respond to the Polling feature.

Setting up Polling Receive

Polling Receive is when you call another fax machine to receive a fax from it.

1 If it is not illuminated in green, press  **(Fax)**.

2 Press **Menu/Set, 2, 1, 6**.

3 Enter the fax number you are polling.

4 Press **Black Start** or **Color Start**.

The LCD shows *Dialing*.

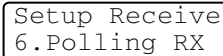

Setup Receive
6.Polling RX

Setting up Sequential Polling Receive

Your MFC can ask for faxes from several fax units in a single operation (Sequential Polling Receive). Afterwards, a Sequential Polling Report will be printed.

1 If it is not illuminated in green, press  **(Fax)**.

2 Press **Menu/Set, 2, 1, 6**.

3 Enter the fax machines you want to poll using Speed-Dial, a Group or the dial pad. You must press **Menu/Set** between each fax number.

4 Press **Black Start** or **Color Start**. Your MFC will poll each number or Group number in turn to receive a fax.



Setup Receive
6.Polling RX

5 Quick-Dial numbers and dialing options

Storing numbers for easy dialing

You can set up your MFC to do two types of easy dialing: Speed-Dial and Groups for Broadcasting faxes. When you dial a quick-dial number, the LCD shows the name, if you stored it, or the number.



If you lose electrical power, the quick-dial numbers that are in the memory will not be lost.

Storing Speed-Dial numbers

You can store Speed-Dial numbers, so that when you dial you will only have to press a few keys (**Search/Speed Dial**, #, the two-digit number, and **Black Start** or **Color Start**). The MFC-5440CN can store 40 Speed-Dial numbers and the MFC-5840CN can store 100 numbers.

1 Press **Menu/Set**, **2**, **3**, **1**.

Set Quick-Dial
1.Speed-Dial

2 Use the dial pad to enter a Speed-Dial location number (01-40 for MFC-5440CN, 00-99 for MFC-5840CN.)
(For example, press **05**.)

Press **Menu/Set**.

3 Enter the phone or fax number (up to 20 digits).

Press **Menu/Set**.

4 Use the dial pad to enter the name (up to 15 characters).

Press **Menu/Set**.

(You can use the chart on page B-12 to help you enter letters.)

—OR—

Press **Menu/Set** to store the number without a name.

5 Go to Step 2 to store another Speed-Dial number.

—OR—

Press **Stop/Exit**.

Changing Speed-Dial numbers

If you try to store a Speed-Dial number where a number has already been stored, the LCD will show the name that has been stored there (or number) and will ask you to do one of the following:

1 Press **1** to change the stored number.

—OR—

Press **2** to exit without making a change.

How to change the stored number or name:

- If you want to change a character, use ◀ or ▶ to position the cursor under the character you want to change, and then type over it.
- If you want to erase the whole number or whole name, press **Stop/Exit** when the cursor is under the first digit or letter. The characters above and to the right of the cursor will be deleted.

2 Enter a new number.

Press **Menu/Set**.

3 Follow the directions beginning at Step 4 in Storing Speed-Dial numbers. (See page 5-1.)

Setting up Groups for Broadcasting

Groups allow you to send the same fax message to many fax numbers by pressing only a few keys (**Search/Speed Dial**, **#**, the two-digit number, and **Black Start**). First, you'll need to store each fax number as a Speed-Dial number.

Then, you can combine them into a Group. Each Group uses up a Speed-Dial number. You can have up to six Groups, or you can assign up to 39 numbers (MFC-5440CN) or up to 99 numbers (MFC-5840CN) to one large Group.

(See *Storing Speed-Dial numbers* on page 5-1 and *Broadcasting* (Not available for color faxes) on page 3-12.)

- 1 Press **Menu/Set**, **2**, **3**, **2**.

```
Set Quick-Dial
2.Setup Groups
```

- 2 Use the dial pad to enter the two-digit Speed-Dial number where you want to store the Group.

```
Setup Groups
Speed-Dial? #
```

Press **Menu/Set**.

(For example, press **07** and **Menu/Set**.)

- 3 Use the dial pad to enter the Group number (1 to 6).

```
Setup Groups
Setup Group:G01
```

Press **Menu/Set**.

(For example, press **1** for Group 1.)



The Group number must be between 1 and 6.

- 4 To include Speed-Dial numbers in the Group, press them as follows:

```
Setup Groups
G01:#05#09
```

For example, for Speed-Dial

numbers 05 and 09. Press **Search/Speed Dial**, **05**, **Search/Speed Dial**, **09**. The LCD shows: #05#09.

- 5 Press **Menu/Set** to accept the Speed-Dial numbers for this Group.
 - 6 Use the dial pad and the chart on page B-12 to enter a name for the Group.
Press **Menu/Set**.
(For example, type NEW CLIENTS).
 - 7 Press **Stop/Exit**.
-  You can print a list of all the Speed-Dial numbers. Group numbers will be marked in the “GROUP” column.
(See *Printing reports* on page 7-3.)

Dialing options



There are three ways to dial. (See *How to dial* on page 3-1.)

Access codes and credit card numbers

Sometimes you may want to choose from several long distance carriers when you make a call. Rates may vary depending on the time and destination. To take advantage of low rates, you can store the access codes or long-distance carriers and credit card numbers as Speed-Dial numbers. You can store these long dialing sequences by dividing them and setting them up on separate Speed Dial numbers in any combination. You can even include manual dialing using the dial pad. (See *Storing Speed-Dial numbers* on page 5-1.)

For example, perhaps you have stored '555' on Speed-Dial #03 and '7000' on Speed-Dial #02. If you press **Search/Speed Dial, #03**, **Search/Speed Dial, #02**, and **Black Start** or **Color Start**, you will dial '555-7000'.

To temporarily change a number, you can substitute part of the number with manual dialing using the dial pad.

For example, to change the number to 555-7001 you could press **Search/Speed Dial, #03** and then press **7001** using the dialing pad.



If you must wait for another dial tone or signal at any point in the dialing sequence, store a pause in the number by pressing **Redial/Pause**. Each key press adds a 3.5-second delay.

Pause

Press **Redial/Pause** to insert a 3.5-second pause between numbers. If you are dialing overseas, you can press **Redial/Pause** as many times as needed to increase the length of the pause.

Tone or Pulse

If you have a Pulse dialing service, but need to send Tone signals (for example, for telephone banking), follow the instructions below. If you have Touch Tone service, you will not need this feature to send tone signals.

- 1** Lift the handset of the external phone.
- 2** Press # on the control panel of your MFC. Any digits dialed after this will send tone signals.

When you hang up, the MFC will return to the Pulse dialing service.

6

Remote Fax Options (Not available for color faxes)



You can only use one remote fax option at a time:
Fax Forwarding—OR—Paging—OR—Fax Storage—OR—
PC FAX Receive—OR—Off.

You can change your selection at any time (**Menu/Set, 2, 5, 1**).
(See *Turning off Remote Fax Options* on page 6-4.)

Setting up Fax Forwarding

When you select Fax Forward, your MFC stores the received fax in the memory. The MFC will then dial the fax number you've programmed and forwards the fax message.

1 Press **Menu/Set, 2, 5, 1**.

Remote Fax Opt
1.Fwd/Page/Store

2 Press **▲** or **▼** to select
Fax Forward.

Press **Menu/Set**.

The LCD will ask you to enter the fax number to which faxes will be forwarded.

3 Enter the forwarding number (up to 20 digits).

Press **Menu/Set**.

4 Press **▲** or **▼** to select
Backup Print:On or
Backup Print:Off.

Fax Forward
Backup Print:On

Press **Menu/Set**.



If you select Backup Print:On, the MFC will also print the fax at your MFC so you will have a copy if there is a power failure before it is forwarded.

5 Press **Stop/Exit**.

Programming your pager number

When Paging is selected, your MFC dials the pager number you've programmed, and then dials your Personal Identification Number (PIN). This activates your pager so you will know that you have a fax message in the memory.

- 1** Press **Menu/Set, 2, 5, 1**.
- 2** Press **▲** or **▼** to select **Paging**.
- 3** Enter your pager phone number followed by **# #** (up to 20 digits). Press **Menu/Set**.

Remote Fax Opt 1.Fwd/Page/Store

Do not include the area code if it is the same as that of your MFC. For example, press **1 8 0 0 5 5 5 1 2 3 4 # #**.

- 4** If your pager needs a PIN, enter the PIN, press **#**, press **Redial/Pause**, enter your fax number followed by **# #**. Press **Menu/Set**.

(For example, press **1 2 3 4 5 # Redial/Pause 1 8 0 0 5 5 5 1 2 1 2 # #**)

—OR—

If you do not need a PIN, press **Redial/Pause**, enter your fax number followed by **# #**.

Press **Menu/Set**.

(For example, press **Redial/Pause 1 8 0 0 5 5 5 1 2 1 2 # #**)

- 5** Press **Stop/Exit**.



- You cannot change a Paging number or PIN remotely.
- If you have set Paging, a backup copy of the received fax will automatically be printed at the MFC.

Setting Fax Storage

If you select Fax Storage, your MFC stores the received fax in the memory. You will be able to retrieve fax messages from another location using the Remote Retrieval commands.

1 Press **Menu/Set, 2, 5, 1.**

Remote Fax Opt
1.Fwd/Page/Store

2 Press **▲** or **▼** to select
Fax Storage.

Press **Menu/Set.**

3 Press **Stop/Exit.**



If you have turned on Fax Storage, a backup copy will automatically be printed at the MFC.

Setting PC Fax Receive

If you select PC Fax Receive, your MFC will temporarily store your received fax messages in its memory, and then automatically send the faxes to the PC. You can then use your PC to view and store these faxes.

1 Press **Menu/Set, 2, 5, 1.**

Remote Fax Opt
1.Fwd/Page/Store

2 Press **▲** or **▼** to select
PC Fax Receive.

Press **Menu/Set.**

3 Press **▲** or **▼** to select
Backup Print:On or
Backup Print:Off.

PC Fax Receive
Backup Print:On

Press **Menu/Set.**

4 Press **Stop/Exit.**



■ Before you can set up PC Fax Receive you must install the MFL-Pro Suite software on your PC, make sure your PC is connected and turned on. (For details, see *Using Brother PC-FAX software* on page 5-1 in Software User's Guide on the CD-ROM.)

■ If you select `Backup Print:On`, the MFC will also print the fax at your MFC so you will have a copy if there is a power failure before it is sent to the PC.

■ If you get an error message and the MFC cannot print the faxes in memory, you can use this setting to transfer your faxes to your PC. (For details, see *Error messages* on page 11-1.)

Turning off Remote Fax Options

If you set the Remote Fax Options to **OFF** and there are faxes in your MFC's memory, the LCD will give you two options.

- If you press **1**, all unprinted faxes will be printed and erased before the setting turns off. If a backup copy has already been printed it will not be printed again.
- If you press **2**, the memory will not be erased and the setting will be unchanged.

(See *Printing a fax from the memory* on page 4-5.)

Setting your Remote Access Code

The remote access code lets you access the Remote Retrieval features when you are away from your MFC. Before you use the remote access and retrieval features, you have to set up your own code. The default code is inactive code (**---***).

1 Press **Menu/Set, 2, 5, 2**.

2 Enter a three-digit code using numbers **0-9** or *****.

Remote Fax Opt
2.Remote Access

Press **Menu/Set**. (The preset '*****' cannot be changed.)

 Do not use the same code which is set in your Fax Receive Code (***51**) or Telephone Answer Code (**#51**).
(See *Operation from extension telephones* on page A-7.)

3 Press **Stop/Exit**.

 You can change your code at any time by entering a new one. If you want to make your code inactive, press **Stop/Exit** in Step 2 to restore the inactive setting (**---***).

Remote Retrieval

You can call your MFC from any touch tone telephone or fax machine, then use the Remote Access Code and remote commands to retrieve fax messages. Be sure to cut out the Remote Retrieval Access Card on the last page and keep it with you at all times.

Using your Remote Access Code

- 1** Dial your fax number from a telephone or another fax machine using touch tone.
 - 2** When your MFC answers, immediately enter your Remote Access Code (3 digits followed by *).
 - 3** The MFC signals if it has received fax messages:
 - 1 long beep — Fax messages**
 - No beeps — No messages**
 - 4** The MFC gives two short beeps to tell you to enter a command. The MFC will hang up if you wait longer than 30 seconds to enter a command. The MFC will beep three times, if you enter an invalid command.
 - 5** Press **90** to reset the MFC when you've finished.
 - 6** Hang up.
-  If your MFC is set to `Manual` mode and you want to use the remote retrieval features, you can access your MFC by waiting about 2 minutes after it starts ringing, and then entering the Remote Access Code within 30 seconds.

Remote commands

Follow the commands below to access features when you are away from the MFC. When you call the MFC and enter your Remote Access Code (3 digits followed by *), the system will give two short beeps and you must enter a remote command.

Remote commands	Operation details
95 Change the Fax Forwarding, Paging or Fax Storage settings	
1 OFF	You can select OFF after you have retrieved or erased all your messages.
2 Fax Forwarding	If you hear one long beep, the change has been accepted. If you hear three short beeps, you cannot change it because something has not been set up (for example, perhaps a Fax Forwarding or Paging number had not been registered). You can register your Fax Forwarding number by entering 4. (See <i>Changing your Fax Forwarding number</i> on page 6-7.) Once you have registered the number, Fax Forwarding will work. You can select OFF after you have retrieved or erased all your messages.
3 Paging	
4 Fax Forwarding number	
6 Fax Storage	
96 Retrieve a fax	
2 Retrieve all faxes	Enter the number of a remote fax machine to receive stored fax message(s). (See page 6-7.)
3 Erase faxes from the memory	If you hear one long beep, fax messages have been erased from the memory.
97 Check the receiving status	
1 Fax	You can check whether your MFC has received any faxes. If yes, you will hear one long beep. If no, you will hear three short beeps.
98 Change the Receive Mode	
1 External TAD	If you hear one long beep, you can change the Receive Mode.
2 Fax/Tel	
3 Fax Only	
90 Exit	Press 90 to exit Remote Retrieval. Wait for the long beep, then replace the handset.

Retrieving fax messages

You can call your MFC from any touch tone phone and have your fax messages sent to a fax machine.

- 1 Dial your fax number.
 - 2 When your MFC answers, immediately enter your Remote Access Code (3 digits followed by *). If you hear one long beep, you have messages.
 - 3 As soon as you hear two short beeps, use the dial pad to press **962**.
 - 4 Wait for the long beep, and then use the dial pad to enter the number of the remote fax machine where you want your fax messages sent to followed by ## (up to 20 digits).
-  You cannot use * and # as dial numbers. However, press # if you want to store a pause.
- 5 Hang up after you hear your MFC beep. Your MFC will call the other machine, which will then print your fax messages.

Changing your Fax Forwarding number

You can change the default setting of your fax forwarding number from another telephone or fax machine using touch tone.

- 1 Dial your fax number.
 - 2 When your MFC answers, immediately enter your Remote Access Code (3 digits followed by *). If you hear one long beep, you have messages.
 - 3 When you hear two short beeps, use the dial pad to press **954**.
 - 4 Wait for the long beep, and then use the dial pad to enter the new number of the remote fax machine where you want your fax messages forwarded followed by ## (up to 20 digits).
-  You cannot use * and # as dial numbers. However, press # if you want to store a pause.
- 5 Hang up after you hear your MFC beep.

7 Printing reports

Fax settings and activity

You need to set up the Transmission Verification Report and Journal Period in the menu table.

Press **Menu/Set, 2, 4, 1.**

—OR—

Press **Menu/Set, 2, 4, 2.**

Report Setting
1.Transmission

Report Setting
2.Journal Period

Customizing the Transmission Verification Report

You can use the Transmission Report as proof that you sent a fax. This report lists the time and date of transmission and whether the transmission was successful (OK). If you select **On** or **On+Image**, the report will print for every fax you send.

If you send a lot of faxes to the same place, you may need more than the job numbers to know which faxes you must send again. Selecting **On+Image** or **Off+Image** will print a section of the fax's first page on the report to help you remember.



When the Verification Report is turned **Off** or **Off+Image**, the Report will only print if there is a transmission error, with NG in the RESULT column.

1 Press **Menu/Set, 2, 4, 1.**

2 Press **▲** or **▼** to select

Off+Image, On, On+Image or **Off.**

Press **Menu/Set.**

3 Press **Stop/Exit.**

Report Setting
1.Transmission

Setting the Journal Period

You can set the MFC to print a journal at specific intervals (every 50 faxes, 6, 12 or 24 hours, 2 or 7 days). If you set the interval to **Off**, you can print the report by following the steps on the next page.

The default setting is **Every 50 Faxes**.

- 1 Press **Menu/Set, 2, 4, 2**.
- 2 Press **▲** or **▼** to choose an interval.
Press **Menu/Set**.

Report Setting
2.Journal Period

(If you choose 7 days, the LCD will ask you to choose a day on which to begin the 7-day countdown.)

- 3 Enter the time to begin printing in 24-hour format.
Press **Menu/Set**.

(For example: enter 19:45 for 7:45 PM.)

- 4 Press **Stop/Exit**.



If you select 6, 12, 24 hours, 2 or 7 days, the MFC will print the report at the selected time and then erase all jobs from its memory. If the MFC's memory becomes full with 200 jobs before the time you selected has passed, the MFC will print the Journal early and then erase all jobs from memory. If you want an extra report before it is due to print, you can print it without erasing the jobs from memory.



If you select **Every 50 Faxes**, the MFC will print the Journal when the MFC has stored 50 jobs.

Printing reports

Following reports are available:

- | | |
|------------------|---|
| 1.Help List | Prints the Help List so you can see at-a-glance how to quickly program your MFC. |
| 2.Quick-Dial | Lists names and numbers stored in the Speed-Dial memory, in numerical order. |
| 3.Fax Journal | Lists information about the last incoming and outgoing faxes.
(TX means Transmit.) (RX means Receive.) |
| 4.Transmission | Prints a Transmission Verification Report for your last transmission. |
| 5.User Settings | Lists your settings. |
| 6.Network Config | Lists your Network settings. |

How to print a report



- 1** For MFC-5440CN, press **Reports**.
For MFC-5840CN, press **Menu/Set**, **6**.
- 2** Press **▲** or **▼** to select the report you want.
Press **Menu/Set**.
—OR—
Enter the number of the report you want to print.
For example, press **1** to print the Help List.
- 3** Press **Black Start**.

8 Making copies

Using the MFC as a copier

You can use your MFC as a copier, making up to 99 copies at a time.

Enter Copy mode

Before making copies, make sure that  (**Copy**) is illuminated in green. If it is not, press  (**Copy**) to enter **Copy** mode. The default setting is Fax. You can change the number of seconds or minutes that the MFC stays in Copy mode. (See *Setting the Mode Timer* on page 2-3.)

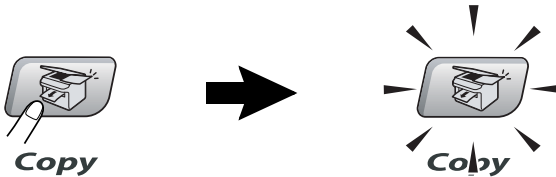

The LCD shows the default copy setting



100% Normal 01

Copy Ratio

Quality

No of Copies

Making a single copy

1 Press  (**Copy**) to illuminate it in green.

2 Load your document.

(See *Load documents* on page 1-7.)

3 Press **Black Start** or **Color Start**.

 To stop copying, press **Stop/Exit**.

Making multiple copies

1 Press  (**Copy**) to illuminate it in green.

2 Load your document.

3 Use the dial pad to enter the number of copies you want (up to 99).

4 Press **Black Start** or **Color Start**.

 To sort the copies, press the **Options** key. (See *Using the temporary Copy keys* on page 8-3.)

Stop copying

To stop copying, press **Stop/Exit**.

Using the temporary Copy keys

When you want to quickly change the copy settings temporarily for the next copy, use the temporary Copy keys. You can use different combinations.

Temporary Copy keys
(For MFC-5440CN)

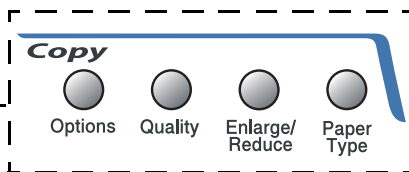

Temporary Copy keys
(For MFC-5840CN)

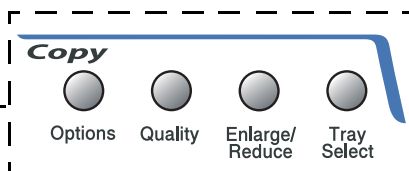





 These settings are temporary, and the MFC returns to its default settings 60 seconds after it finishes copying. However if you have set the Mode Timer to 0 or 30 seconds, the MFC returns to the default settings after the number of seconds that has been set for mode timer. (See *Setting the Mode Timer* on page 2-3.)

 You can save the copy settings you use most often by setting them as default. (See *Changing the default copy settings* on page 8-16.)

Increasing copy speed or quality

You can select the copy quality. The default setting is *Normal*.



<p>Press Quality</p>  <p>Quality</p> <p>and</p>  or 	Normal	Recommended mode for ordinary printouts. Good copy quality with adequate copy speed.
	Fast	Fast copy speed and lowest ink consumption. Use FAST to save time (document to be proof-read, large documents or many copies).
	Best	Use this mode to copy precise images such as photographs. BEST uses the highest resolution and slowest speed.

- 1 Press  (**Copy**) to illuminate it in green.
- 2 Load your document.
- 3 Use the dial pad to enter the number of copies you want (up to 99).
- 4 Press **Quality**.
- 5 Press **▲** or **▼** to choose the copy quality (*Fast*, *Normal* or *Best*).
Press **Menu/Set**.
- 6 Press **Black Start** or **Color Start**.

Enlarging or reducing the image copied

You can select the following enlargement or reduction ratios.

Custom (25–400%) allows you to enter a ratio from 25% to 400%.

<p>Press Enlarge/Reduce</p>  <p>Enlarge/ Reduce</p> <p>and  or  to select</p> <p>Enlarge/Reduce</p>	Custom (25–400%)
	200%
	198% 4" x 6" → A4
	186% 4" x 6" → LTR
	142% A5 → A4
	104% EXE → LTR
	100%
	97% LTR → A4
	93% A4 → LTR
	83% LGL → A4
	78% LGL → LTR
	69% A4 → A5
	50%

- 1 Press  (**Copy**) to illuminate it in green.
- 2 Load your document.
- 3 Use the dial pad to enter the number of copies you want (up to 99).
- 4 Press **Enlarge/Reduce**.
- 5 Press **▲** or **▼** to select the enlargement or reduction ratio you want.

Press **Menu/Set**.

—OR—

You can select Custom (25–400%) and press **Menu/Set**.

Use the dial pad to enter an enlargement or reduction ratio from 25% to 400%.

Press **Menu/Set**.

(For example, press **5 3** to enter 53%.)

6 Press **Black Start** or **Color Start**.

 Special Copy Options 2 in 1 (P), 2 in 1 (L), 4 in 1 (P), 4 in 1 (L) or Poster are not available with Enlarge/Reduce.

Setting the paper type (MFC-5440CN only)

If you are copying on special paper, be sure to select the type of paper you are using so you will get the best print quality.

- 1** Press  (**Copy**) to illuminate it in green.
- 2** Load your document.
- 3** Use the dial pad to enter the number of copies you want (up to 99).
- 4** Press **Paper Type**.
- 5** Press **▲** or **▼** to select the type of paper you are using (Plain, Inkjet, Glossy or Transparency).
Press **Menu/Set**.
- 6** Press **Black Start** or **Color Start**.

 You can change the default Paper Type setting at any time.
(See *Setting the Paper Type* on page 2-3.)

Using the Tray Select key (MFC-5840CN only)

The MFC uses the paper in Tray#1 first. You can change the tray that will be used for next copy only.

- 1 Press  (**Copy**) to illuminate it in green.
- 2 Load your document.
- 3 Use the dial pad to enter the number of copies you want (up to 99).
- 4 Press **Tray Select**.
- 5 Press **▲** or **▼** to select `Auto`, #1 (xxx) or #2 (xxx).
Press **Menu/Set**.
- 6 Press **Black Start** or **Color Start**.



- If both trays are using paper that is the same type and size, `Auto` will allow your MFC to take paper from Tray#2 if Tray#1 is out of paper.
- You can only use plain paper sizes Letter, Legal or A4 in Tray#2.

Changing the temporary copy settings

Use the **Options** key to quickly set the following copy settings temporarily for the next copy.

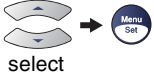
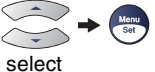
Press Options 	Menu Selections  select	Options  select	Factory Setting	Page
	Paper Type (MFC-5840CN only)	Plain/Inkjet/ Glossy/ Transparency	Plain	8-9
	Paper Size	Letter/Legal/ A4/A5/ 4" (W) x 6" (H)	Letter	8-9
	Brightness	- ■■■■ +	- ■■■■ +	8-10
	Contrast	- ■■■■ +	- ■■■■ +	8-11
	Stack/Sort	Stack/Sort	Stack	8-11
	Page Layout	Off(1 in 1)/ 2 in 1 (P)/ 2 in 1 (L)/ 4 in 1 (P)/ 4 in 1 (L)/ Poster(3 x 3)	Off (1 in 1)	8-16
	No. of Copies	No. of Copies:01 (01-99)	01	

After you choose your settings by pressing **Menu/Set**, the LCD shows `Set` temporarily.

Press **Black Start** or **Color Start** if you're finished choosing settings.

—OR—

Press **▲** or **▼** to select more settings.

Setting paper type (MFC-5840CN only)

If copying on paper other than plain paper, select the type of paper that you are using to get the best print quality.

- 1 Press  (**Copy**) to illuminate it in green.
- 2 Load your document.
- 3 Use the dial pad to enter the number of copies you want (up to 99).
- 4 Press **Options** and ▲ or ▼ to select `Paper Type`.
Press **Menu/Set**.
- 5 Press ▲ or ▼ to select the type of paper you are using (`Plain`, `Inkjet`, `Glossy` or `Transparency`).
Press **Menu/Set**.



You can only use plain paper in Tray#2.

- 6 Press **Black Start** or **Color Start**.



You can change the default Paper Type setting at any time.
(See *Setting the Paper Type* on page 2-3.)

Setting paper size

If copying on paper other than Letter size, you will need to change the paper size setting.



- You can copy on Letter, Legal, A4, A5 or Photo Card (4"(W) x 6"(H)) paper.
- You can only use this setting with Tray#1.

- 1 Press  (**Copy**) to illuminate it in green.
- 2 Load your document.
- 3 Use the dial pad to enter the number of copies you want (up to 99).

- 4 Press **Options** and ▲ or ▼ to select `Paper Size`.
Press **Menu/Set**.
- 5 Press ▲ or ▼ to select the size of paper you are using
(`Letter`, `Legal`, `A4`, `A5` or `4" (W) x 6" (H)`).
Press **Menu/Set**.
- 6 Press **Black Start** or **Color Start**.

Adjusting brightness

You can adjust the copy brightness to make copies darker or lighter.

- 1 Press  (**Copy**) to illuminate it in green.
- 2 Load your document.
- 3 Use the dial pad to enter the number of copies you want
(up to 99).
- 4 Press **Options** and ▲ or ▼ to select `Brightness`.
Press **Menu/Set**.
- 5 Press ▲ to make a lighter copy.
—OR—
Press ▼ to make a darker copy.
Press **Menu/Set**.
- 6 Press **Black Start** or **Color Start**.

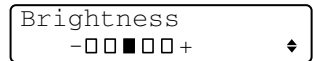

Adjusting contrast

You can adjust the copy contrast to help an image look sharper and more vivid.

- 1 Press  (**Copy**) to illuminate it in green.
- 2 Load your document.
- 3 Use the dial pad to enter the number of copies you want (up to 99).
- 4 Press **Options** and ▲ or ▼ to select **Contrast**.
Press **Menu/Set**.
- 5 Press ▲ to increase the contrast.
—OR—
Press ▼ to decrease the contrast.
Press **Menu/Set**.
- 6 Press **Black Start** or **Color Start**.



Sorting copies using the ADF

You can sort multiple copies. Pages will be stacked in the order 321, 321, 321, and so on.

- 1 Press  (**Copy**) to illuminate it in green.
- 2 Load your document.
- 3 Use the dial pad to enter the number of copies you want (up to 99).
- 4 Press **Options** and ▲ or ▼ to select **Stack/Sort**.
Press **Menu/Set**.
- 5 Press ▲ or ▼ to select **Sort**.
Press **Menu/Set**.
- 6 Press **Black Start** or **Color Start**.

Making N in 1 copies or a poster (Page Layout)

You can reduce the amount of copies by using the N in 1 copy feature. This allows you to copy two or four pages on one page, which allows you to save paper. It is also possible to create a poster. When you use the Poster feature your MFC divides your document into sections, then enlarges the sections so you can assemble them into a poster. If you want to print a poster, use the scanner glass.



- Please make sure Paper Size is set to `Letter` or `A4`.
- You can use N in 1 copy feature with 100% copy size only.
- (P) means Portrait and (L) means Landscape.

- 1 Press  (**Copy**) to illuminate it in green.
- 2 Load your document.
- 3 Use the dial pad to enter the number of copies you want (up to 99).
- 4 Press **Options** and ▲ or ▼ to select `Page Layout`.
Press **Menu/Set**.
- 5 Press ▲ or ▼ to select `2 in 1 (P)`, `2 in 1 (L)`,
`4 in 1 (P)`, `4 in 1 (L)`, `Poster (3 x 3)` or `Off (1 in 1)`.
Press **Menu/Set**.
- 6 Press **Black Start** or **Color Start** to scan the document.
- 7 If you are making a poster or placed the document in the ADF, the MFC scans document and starts printing.

If you are using the scanner glass:

8 After the MFC scans the page, the LCD shows:

Next Page?
1.Yes 2.No

Press **1** to scan the next page.

9 Put the next document on the scanner glass.

Set Next Page
Then Press Set

Press **Menu/Set**.

Repeat Steps 8 and 9 for each page of the layout.

10 After all the pages of the document have been scanned, press **2** to end.



If **Inkjet** has been selected in the Paper Type setting for N in 1 copies, the MFC will print the images as if Plain paper had been selected.



■ If you are producing multiple color copies, N in 1 copies are not available.

■ For Poster copies, you cannot make more than one copy.

If you are copying from the ADF, insert the document face *up* in the direction shown below.

2 in 1 (P)



2 in 1 (L)

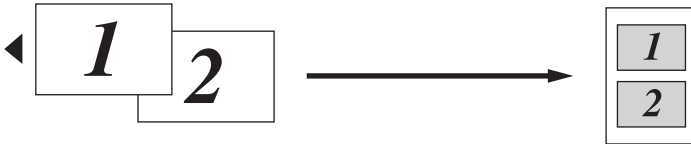

4 in 1 (P)

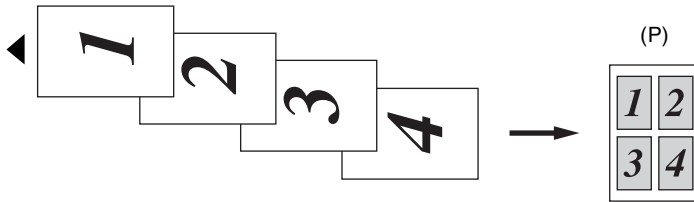

4 in 1 (L)



If you are copying from the scanner glass, place the document face *down* in the direction shown below.

2 in 1 (P)



2 in 1 (L)

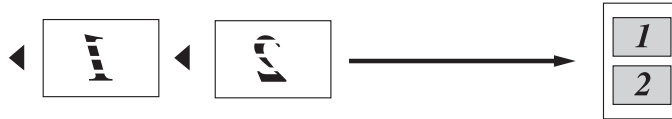

4 in 1 (P)



4 in 1 (L)



Poster (3X3)

You can make a poster size copy of a photograph.

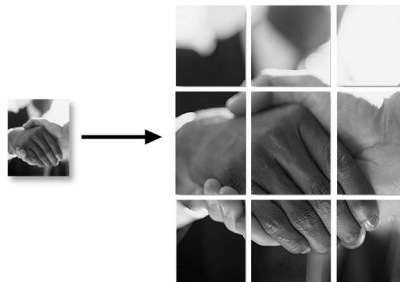

Changing the default copy settings

You can save the copy settings you use most often by setting them as default. These settings will remain until you change them again.

Increasing copy speed or quality

- 1 Press **Menu/Set**, **3**, **1**.
- 2 Press **▲** or **▼** to select **Normal**, **Best** or **Fast**.
Press **Menu/Set**.
- 3 Press **Stop/Exit**.

Copy
1.Quality

Adjusting brightness

- 1 Press **Menu/Set**, **3**, **2**.
- 2 Press **▲** to make a lighter copy.
—OR—
Press **▼** to make a darker copy.
Press **Menu/Set**.
- 3 Press **Stop/Exit**.

Copy
2.Brightness

Adjusting contrast

You can change the contrast to help an image look sharper and more vivid.

- 1 Press **Menu/Set**, **3**, **3**.
- 2 Press **▲** to increase the contrast.
—OR—
Press **▼** to decrease the contrast.
Press **Menu/Set**.
- 3 Press **Stop/Exit**.

Copy
3.Contrast

Adjusting color saturation

- 1 Press **Menu/Set**, **3**, **4**.
- 2 Press **▲** or **▼** to select **Red**, **Green** or **Blue**.

Copy 4.Color Adjust

Press **Menu/Set**.

- 3 Press **▲** to increase the color saturation.
—OR—

Press **▼** to decrease the color saturation.

Press **Menu/Set**.

- 4 Return to Step 2 to select the next color.
—OR—

Press **Stop/Exit**.

Out of Memory message

If the memory becomes full while you are making copies, the LCD message will guide you through the next step.

If the **Out of Memory** message appears, press **Stop/Exit** to cancel or **Black Start** or **Color Start** to copy the scanned pages. You will need to clear some jobs from the memory before you can continue.



To gain extra memory, you can turn off Fax Storage.
(See *Setting Fax Storage* on page 6-3.)

—OR—

Print the faxes that are in the memory.

(See *Printing a fax from the memory* on page 4-5.)

When you get an **Out of Memory** message, you may be able to make copies if you first print incoming faxes in the memory to restore the memory to 100%.

Legal limitations

Color reproductions of certain documents are illegal and may result in either criminal or civil liability. This memorandum is intended to be a guide rather than a complete listing of every possible prohibition. In case of doubt, we suggest that you check with counsel as to any particular questionable documents.

The following documents issued by the United States/Canadian Government or any of its Agencies may not be copied:

- Money
- Bonds or other certificates of indebtedness
- Certificates of Deposit
- Internal Revenue Stamps (canceled or uncanceled)
- Selective Service or draft papers
- Passports
- United States/Canadian Postage Stamps (canceled or uncanceled)
- Food Stamps
- Immigration Papers
- Checks or drafts drawn by Governmental agencies
- Identifying badges or insignias

Copyrighted works cannot be copied. Sections of a copyrighted work can be copied for 'fair use.' Multiple copies would indicate improper use.

Works of art should be considered the equivalent of copyrighted works.

Licenses and Certificates of Title to motor vehicles may not be copied under certain state/provincial laws.

9

Walk-Up PhotoCapture Center™ (MFC-5840CN only)

Introduction

Even if your MFC is not connected to your computer, you can print photos directly from the digital camera media. Your Brother MFC includes five media drives (slots) for use with popular digital camera media: CompactFlash®, SmartMedia®, Memory Stick®, SecureDigital™, and xD-Picture Card™.



CompactFlash®
(Type I only)



SmartMedia®



Memory Stick®



SecureDigital™

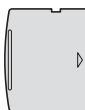

xD-Picture Card™

The PhotoCapture Center™ feature lets you print digital photos from your digital camera at high resolution to get photo quality printing.



- miniSD™ can be used with miniSD™ adapter.
- Memory Stick Duo™ can be used with Memory Stick Duo™ adapter.
- Adapters are not included with the MFC. Contact a third party supplier for adapters.





You cannot use Tray#2 with the PhotoCapture Center™ feature.

PhotoCapture Center™ requirements

To avoid error conditions, please remember:

- The DPOF file on the media card must be in a valid format. (See *DPOF printing* on page 9-8.)
- The image file extension must be .JPG (Other image file extensions .JPEG, .TIF, .GIF and so on will not be recognized).
- Walk-up PhotoCapture Center™ printing must be performed separately from PhotoCapture Center™ operations using the PC. (Simultaneous operation is not available.)
- IBM Microdrive™ is not compatible with the MFC.
- The MFC can read up to 999 files in a media card.
- Use only Smart media cards with a 3.3v voltage rating.
- CompactFlash® Type II is not supported.

 When printing the INDEX or IMAGE, the PhotoCapture Center™ will print all the valid images, even if one or more images have been corrupted. A portion of the corrupted image may be printed.

 Your MFC is designed to read media cards that have been formatted by a digital camera.

When a digital camera formats a media card it creates a special folder into which it copies image data. If you need to modify the image data stored on a media card with your PC, we recommend that you do not modify the folder structure created by the digital camera. When saving new or modified image files to the media card we also recommend you use the same folder your digital camera uses. If the data is not saved to the same folder the MFC may not be able to read the file or print the image.

Getting started

Firmly insert the card into the appropriate slot.

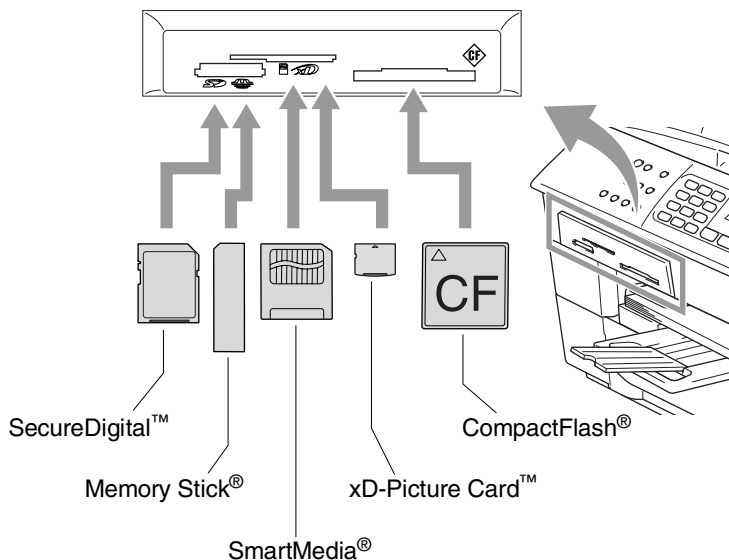

PhotoCapture key lights:

- **PhotoCapture** light is ON, the media card is inserted properly.
- **PhotoCapture** light is OFF, the media card is not properly inserted.
- **PhotoCapture** light is BLINKING, the media card is being read or written to.



Do NOT unplug the power cord or remove the media card from the media drive (slot) while the MFC is reading or writing to the card (the **PhotoCapture** key is blinking). **You will lose your data or damage the card.**

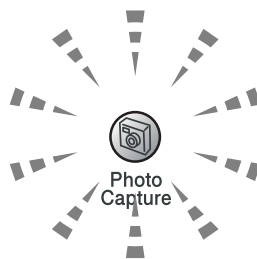

The MFC can only read one media card at a time so do not insert more than one card.

The steps below give a brief outline of the Direct Printing feature. Please see the remaining pages of this chapter for more detailed instructions.

- 1** Insert the media card firmly into the media drive (slot).

When you insert your media card into the proper slot, the LCD shows.

C.Flash Active
Press PhotoCapture key...



The media active message will be shown for 60 seconds and then disappear. Even in that case, you can enter the PhotoCapture mode by pressing **PhotoCapture**.

- 2** Press **PhotoCapture**.

If your digital camera supports DPOF printing, see *DPOF printing* on page 9-8.

- 3** Print the index that shows thumbnail views of images stored on your media card. Your MFC will give an image number to each thumbnail.

Press **Print Index**.

Press **Color Start** to start printing the index sheet.

(See *Printing the Index (Thumbnails)* on page 9-5.)

- 4** To print images, press **▲** or **▼** to select **Print Images** and then press **Menu/Set**.

Enter the image number and press **Menu/Set**.

Press **Color Start** to start printing.

(See *Printing images* on page 9-6.)



You can change the settings for printing images, such as the Paper Type & Paper Size, Print Size and number of copies.

(See *Printing images* on page 9-6.)

Printing the Index (Thumbnails)

The PhotoCapture Center™ assigns numbers for images (such as No.1, No.2, No.3, and so on).



➔ No. 1
DEI.JPG

01.01.2003
100KB

It does not recognize any other numbers or file names that your digital camera or PC have used to identify the pictures. You can print a thumbnail page (Index page with 6 or 5 images per line). This will show all the pictures on the media card.

- 1 Make sure you have inserted the media card.
Press **PhotoCapture**. (See page 9-3.)
- 2 Press **Print Index**.
- 3 Press **▲** or **▼** to select 6 Images/Line or 5 Images/Line.
Press **Menu/Set**.

Index

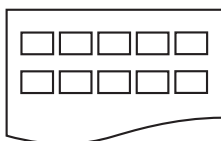

5 Images/Line

Index

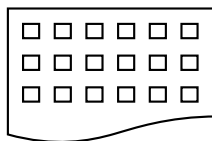

6 Images/Line

- 4 Press **Color Start** to start printing.



Print time for 5 Images/Line will be slower than 6 Images/Line, but the quality is better. To print an image, see *Printing images* on page 9-6.

Printing images

Before you can print an individual image, you have to know the image number.



Print the Index first.

(See *Printing the Index (Thumbnails)* on page 9-5.)

1

Make sure you have inserted the media card.

Press **PhotoCapture**. (See page 9-3.)

2

Press **▲** or **▼** to choose *Print Images*.

Press **Menu/Set**.



If your media card contains valid DPOF information, the LCD shows *DPOF Print: Yes, please go to DPOF printing on page 9-8*.

3

Use the dial pad to enter the image number that you want to print from the Index page (Thumbnails).

Enter & Set Key No. : 1, 3, 6

Press **Menu/Set**.

Repeat this step until you have entered all the image numbers that you want to print.



You can enter all the numbers at one time by using the ***** key for a comma or the **#** key for hyphen.

(For example, Enter **1 * 3 * 6** - to print images No.1, No.3 and No.6. Enter **1#5** to print images No.1 to No.5).

4

After you have selected all the image numbers, press **Menu/Set** again, and go to Step 5.

—**OR**—

If you have finished choosing settings, press **Color Start**.

Paper Type & Paper Size

- 5** Press ▲ or ▼ to select the type of paper you are using, Letter Glossy, 4"x 6" Glossy, 5"x 7" Glossy, A4 Glossy, Letter Plain, A4 Plain, Letter Inkjet, A4 Inkjet or 4"x 6" Inkjet.

Press **Menu/Set**.

If you selected Letter or A4, go to Step 6.

If you selected another size, go to Step 7.

—OR—

If you have finished choosing settings, press **Color Start**.

Print Size





- 6** If you selected Letter or A4, press ▲ or ▼ to select the print size (4"x 3", 5"x 3.5", 6"x 4", 7"x 5", 8"x 6" or Max. Size).

Press **Menu/Set**, and go to Step 7.

—OR—

If you have finished choosing settings, press **Color Start**.

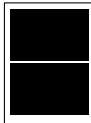
Printed Position for Letter paper

1 4"x 3"	2 5"x 3.5"	3 6"x 4"	4 7"x 5"	5 8"x 6"	6 Max. Size
					

Number of Copies

- 7** Use the dial pad to enter the number of copies you want.

Press **Menu/Set**.

- 8** Press **Color Start** to print.



Your temporary settings will be kept until you take out the media card from the drive (slot), print images or press **Stop/Exit**.

DPOF printing

DPOF stands for Digital Print Order Format.

Major Digital Camera manufacturers (Canon Inc., Eastman Kodak Company, Fuji Photo Film Co. Ltd., Matsushita Electric Industrial Co. Ltd. and Sony Corporation.) created this standard to make it easier to print images from a digital camera.

If your digital camera supports DPOF printing, you will be able to select on the Digital Camera display the images and number of copies you want to print.

When the memory card (CompactFlash®, SmartMedia®, Memory Stick®, SecureDigital™ and xD-Picture Card™) with DPOF information is put into your MFC, you can print the selected image easily.

- 1 Insert your media card into the proper drive (slot).

C.Flash Active
Press PhotoCapture key...



The media active message will be shown for 60 seconds and then disappear. Even in that case, you can enter the PhotoCapture mode by pressing **PhotoCapture**.

- 2 Press **PhotoCapture**.
- 3 Press ▲ or ▼ to select `Print Images`.
Press **Menu/Set**.

- 4 If there is a DPOF file on the card, the LCD shows:

Select ▲▼ & Set
DPOF Print:Yes

- 5 Press ▲ or ▼ to select
`DPOF Print:Yes`.
Press **Menu/Set**.



If you want to choose the images and their print options now, select `DPOF Print:No`.

- 6 Press **Color Start** to print.

Changing the default settings

You can save the PhotoCapture Center™ settings you use most often by setting them as default. These settings will remain until you change them again.

Increasing print speed or quality

- 1** Press **Menu/Set**, **4**, **1**.
- 2** Press **▲** or **▼** to select **Normal** or **Photo**.
Press **Menu/Set**.
- 3** Press **Stop/Exit**.

PhotoCapture
1.Print Quality

Setting the paper & size

- 1** Press **Menu/Set**, **4**, **2**.
- 2** Press **▲** or **▼** to select
Letter Glossy, **4"x 6" Glossy**,
5"x 7" Glossy, **A4 Glossy**, **Letter Plain**, **A4 Plain**,
Letter Inkjet, **A4 Inkjet** or **4"x 6" Inkjet**.
Press **Menu/Set**.
If you selected **Letter** or **A4**, press **▲** or **▼** to select the print
size (**4"x 3"**, **5"x 3.5"**, **6"x 4"**, **7"x 5"**, **8"x 6"** or
Max. Size).
Press **Menu/Set**.
- 3** Press **Stop/Exit**.

PhotoCapture
2.Paper & Size

Adjusting brightness

- 1 Press **Menu/Set**, 4, 3.
- 2 Press **▲** to make a lighter print.
—OR—
Press **▼** to make a darker print.
Press **Menu/Set**.
- 3 Press **Stop/Exit**.

PhotoCapture
3.Brightness

Adjusting contrast

You can choose the contrast setting. More contrast will make an image look sharper and more vivid.

- 1 Press **Menu/Set**, 4, 4.
- 2 Press **▲** to increase the contrast.
—OR—
Press **▼** to decrease the contrast.
Press **Menu/Set**.
- 3 Press **Stop/Exit**.

PhotoCapture
4.Contrast

Color enhancement (True2Life®)

You can turn on the color enhancement (True2Life®) feature to print more vivid images. Printing time will be slower.

- 1 Press **Menu/Set**, 4, 5.
- 2 Press **▲** or **▼** to select **On**.
Press **Menu/Set**.
—OR—

PhotoCapture
5.True2Life

Select **Off** and press **Menu/Set**, then go to Step 5.



If you select **On**, you can customize the White Balance, Sharpness or Color Density.

- 3 Press ▲ or ▼ to select **White Balance**, **Sharpness** or **Color Density**.
Press **Menu/Set**.
- 4 Press ▲ or ▼ to adjust the degree of the setting.
Press **Menu/Set**.
- 5 Press **Stop/Exit**.

■ **White Balance**

This setting adjusts the hue of the white areas of an image. Lighting, camera settings and other influences will effect the appearance of white. The white areas of a picture may be slightly pink, yellow or some other color. By using this adjustment you can correct this effect and bring the white areas back to pure white.

■ **Sharpness**

This setting enhances the detail of an image. It is similar to adjusting the fine focus on a camera. If the image is not in true focus and you cannot see the fine details of the picture, then adjust the sharpness.

■ **Color Density**

This setting adjusts the total amount of color in the image. You can increase or decrease the amount of color in an image to improve a washed out or weak picture.

Cropping

If your photo is too long or wide to fit the available space on your selected layout, part of the image will be automatically cropped.

The default setting is *On*. If you want to print the whole image, turn this setting to *Off*.

- 1 Press **Menu/Set**, **4**, **6**.
- 2 Press **▲** or **▼** to select *Off* (or *On*).
Press **Menu/Set**.
- 3 Press **Stop/Exit**.

Cropping: *On*

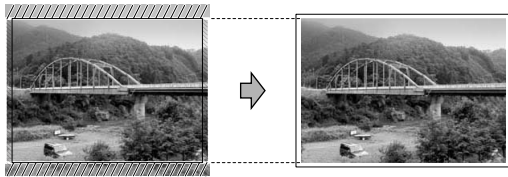

Cropping: *Off*

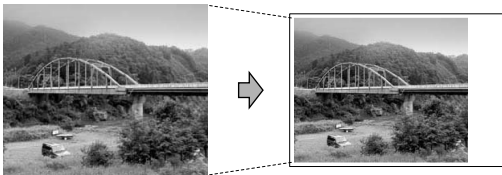

Borderless

This feature expands the printable area to the edges of the paper. Printing time will be slightly slower.

- 1 Press **Menu/Set**, **4**, **7**.
- 2 Press **▲** or **▼** to select *Off* (or *On*).
Press **Menu/Set**.
- 3 Press **Stop/Exit**.

Understanding the Error Messages

Once you are familiar with the types of errors that can occur while you're using the PhotoCapture Center™, you can easily identify and troubleshoot any difficulties.

When an error message appears on the LCD, the MFC will beep to get your attention.

Media Error—This message will appear if you insert a media card that is either bad or not formatted, or when there is a problem with the media drive. To clear this error, take out the media card.

No File—This message will appear if you try to access a media card in the drive (slot) that does not contain a .JPG file.

Out of Memory—This message will appear if you are working with images that are too large for the MFC's memory.

Using PhotoCapture Center™ from your PC

You can access the media card that is in the media drive (slot) of the MFC from your PC.

(See *Using the PhotoCapture Center™ from your PC* on page 6-1 in Software User's Guide on the CD-ROM or *Using the PhotoCapture Center™ from a Macintosh®* (not available for MFC-3240C and MFC-5440CN) on page 8-45 in the Software User's Guide on the CD-ROM.)

Using PhotoCapture Center™ for scanning documents

You can scan documents and save them on a media card to quickly and easily make documents portable. (See *Scan to Card* (not available for MFC-3240C, MFC-210C and MFC-5440CN) on page 2-23 in Software User's Guide on the CD-ROM.)

10 Important information

Standard telephone and FCC Notices

These notices are in effect on models sold and used in the United States only.

When programming emergency numbers or making test calls to emergency numbers:

- Remain on the line and briefly explain to the dispatcher the reason for the call before hanging up.
- Perform these activities in the off-peak hours, such as early morning or late evening.

This equipment complies with Part 68 of the FCC rules and the requirements adopted by the ACTA. On the backside of this equipment is a label that contains, among other information, a product identifier in the format US: AAAEQ##TXXXX. If requested, this number must be provided to the telephone company.

You may safely connect this equipment to the telephone line by means of a standard modular jack, USOC RJ11C.

A plug and jack used to connect this equipment to the premises wiring and telephone network must comply with the applicable FCC Part 68 rules and requirements adopted by the ACTA. A compliant telephone cord and modular plug is provided with this product. It is designed to be connected to a compatible modular jack that is also compliant. See installation instructions for details.

The REN is used to determine the number of devices that may be connected to a telephone line. Excessive RENs on a telephone line may result in the devices not ringing in response to an incoming call. In most but not all areas, the sum of RENs should not exceed five (5.0). To be certain of the number of devices that may be connected to a line, as determined by the total RENs, contact the local telephone company. For products approved after July 23, 2001, the REN for this product is part of the product identifier that has the format US:AAAEQ##TXXXX. The digits represented by ## are the REN without a decimal point (e.g., 06 is a REN of 0.6). For earlier products, the REN is separately shown on the label.

If this equipment causes harm to the telephone network, the telephone company will notify you in advance that temporary discontinuance of service may be required. But if advance notice isn't practical, the telephone company will notify the customer as soon as possible. Also, you will be advised of your right to file a complaint with the FCC if you believe it is necessary.

The telephone company may make changes in its facilities, equipment, operations or procedures that could affect the operation of the equipment. If this happens the telephone company will provide advance notice in order for you to make necessary modifications to maintain uninterrupted service.

If trouble is experienced with this equipment, for repair or warranty information, please contact Brother Customer Service. (See *Brother numbers* on page i.) If the equipment is causing harm to the telephone network, the telephone company may request that you disconnect the equipment until the problem is resolved.

Connection to party line service is subject to state tariffs. Contact the state public utility commission, public service commission or corporation commission for information.

If your home has specially wired alarm equipment connected to the telephone line, ensure the installation of this equipment does not disable your alarm equipment. If you have questions about what will disable alarm equipment, call your telephone company or a qualified installer.

If you are not able to solve a problem with your MFC, call Brother Customer Service. (See *Brother numbers* on page i.)

WARNING

For protection against the risk of electrical shock, always disconnect all cables from the wall outlet before servicing, modifying or installing the equipment.

This equipment may not be used on coin service lines provided by the telephone company or connected to party lines.

Brother cannot accept any financial or other responsibilities that may be the result of your use of this information, including direct, special or consequential damages. There are no warranties extended or granted by this document.

⚠ WARNING

This MFC has been certified to comply with FCC standards, which are applied to the USA only. A grounded plug should be plugged into a grounded AC power outlet after checking the rating of the local power supply for the MFC to operate properly and safely.

Federal Communications Commission (FCC) Declaration of Conformity (USA only)

Responsible Party: Brother International Corporation
100 Somerset Corporate Boulevard
Bridgewater, NJ 08807-0911 USA
TEL: (908) 704-1700

declares, that the products

Product Name: MFC-5440CN, MFC-5840CN

comply with Part 15 of the FCC Rules. Operation is subject to the following two conditions: (1) This device may not cause harmful interference, and (2) this device must accept any interference received, including interference that may cause undesired operation.

This equipment has been tested and found to comply with the limits for a Class B digital device, pursuant to Part 15 of the FCC Rules. These limits are designed to provide reasonable protection against harmful interference in a residential installation. This equipment generates, uses, and can radiate radio frequency energy and, if not installed and used in accordance with the instructions, may cause harmful interference to radio communications. However, there is no guarantee that interference will not occur in a particular installation. If this equipment does cause harmful interference to radio or television reception, which can be determined by turning the equipment off and on, the user is encouraged to try to correct the interference by one or more of the following measures:

- Reorient or relocate the receiving antenna.
- Increase the separation between the equipment and receiver.
- Connect the equipment into an outlet on a circuit different from that to which the receiver is connected.
- Call the dealer or an experienced radio/TV technician for help.

Important

Changes or modifications not expressly approved by Brother Industries, Ltd. could void the user's authority to operate the equipment.

Industry Canada Compliance Statement (Canada only)

This Class B digital apparatus complies with Canadian ICES-003.
Cet appareil numérique de la classe B est conforme à la norme NMB-003 du Canada.

For your safety

To ensure safe operation the supplied three-pin plug must be inserted only into a standard three-pin AC power outlet that is effectively grounded through the normal household wiring.

The fact that the equipment operates satisfactorily does not imply that the power is grounded and that the installation is completely safe. For your safety, if in any doubt about the effective grounding of the power, call a qualified electrician.

LAN connection



Caution

Do not connect this product to a LAN connection that is subject to over-voltages.

International ENERGY STAR® Compliance Statement

The purpose of the International ENERGY STAR® Program is to promote the development and popularization of energy-efficient office equipment.

As an ENERGY STAR® Partner, Brother Industries, Ltd. has determined that this product meets the ENERGY STAR® guidelines for energy efficiency.



Important safety instructions

- 1** Read all of these instructions.
- 2** Save them for later reference.
- 3** Follow all warnings and instructions marked on the product.
- 4** Unplug this product from the wall outlet before cleaning. Do not use liquid or aerosol cleaners. Use a damp cloth for cleaning.
- 5** Do not use this product near water.
- 6** Do not place this product on an unstable cart, stand, or table. The product may fall, causing serious damage to the product.
- 7** Slots and openings in the cabinet and the back or bottom are provided for ventilation; to ensure reliable operation of the product and to protect it from overheating, these openings must not be blocked or covered. The openings should never be blocked by placing the product on a bed, sofa, rug, or other similar surface. This product should never be placed near or over a radiator or heater. This product should never be placed in a built-in installation unless proper ventilation is provided.
- 8** This product should be operated from the type of power source indicated on the label. If you are not sure of the type of power available, call your dealer or local power company.
Use only the power cord supplied with this MFC.
- 9** This product is equipped with a 3-wire grounded plug, a plug having a third (grounded) pin. This plug will only fit into a grounded power outlet. This is a safety feature. If you are unable to insert the plug into the outlet, call your electrician to replace your obsolete outlet. Do not defeat the purpose of the grounded plug.
- 10** Do not allow anything to rest on the power cord. Do not place this product where people can walk on the cord.
- 11** If an extension cord is used with this product, make sure that the total ampere ratings on the products plugged into the extension cord do not exceed the extension cord ampere rating. Also, make sure that the total of all products plugged into the AC power outlet does not exceed 15 amperes (USA only).

- 12** Do not place anything in front of the MFC that will block received faxes. Do not place anything in the path of received faxes.
- 13** Wait until pages have exited the MFC before picking them up.
- 14** Never push objects of any kind into this product through cabinet slots, since they may touch dangerous voltage points or short out parts resulting in the risk of fire or electric shock. Never spill liquid of any kind on the product. Do not attempt to service this product yourself because opening or removing covers may expose you to dangerous voltage points and other risks and may void your warranty. Refer all servicing to a Brother Authorized Service Center. For the location of your nearest Brother Authorized Service Center, please call **In USA:** 1-800-284-4357 or **In Canada:** 1-877-BROTHER. (See *Brother numbers* on page i.)
- 15** Unplug this product from the AC power outlet and refer servicing to Authorized Service Personnel under the following conditions:
- When the power cord is damaged or frayed.
 - If liquid has been spilled into the product.
 - If the product has been exposed to rain or water.
 - If the product does not operate normally when the operating instructions are followed. Adjust only those controls that are covered by the operating instructions. Improper adjustment of other controls may result in damage and will often require extensive work by a qualified technician to restore the product to normal operation.
 - If the product has been dropped or the cabinet has been damaged.
 - If the product exhibits a distinct change in performance, indicating a need for service.
- 16** To protect your product against power surges, we recommend the use of a power protection device (Surge Protector).

Trademarks

The Brother logo is a registered trademark of Brother Industries, Ltd.

Brother is a registered trademark of Brother Industries, Ltd.

Multi-Function Link is a registered trademark of Brother International Corporation.

© 2004 Brother Industries, Ltd. All rights reserved.

Windows and Microsoft are registered trademarks of Microsoft in the U.S. and other countries.

Macintosh and TrueType are registered trademarks of Apple Computer, Inc.

PaperPort and OmniPage OCR are registered trademarks of ScanSoft, Inc.

Presto! PageManager is a registered trademark of NewSoft Technology Corporation.

Microdrive is a trademark of International Business Machine Corporation.

SmartMedia is a registered trademark of Toshiba Corporation.

CompactFlash is a registered trademark of SanDisk Corporation.

Memory Stick is a registered trademark of Sony Corporation.

SecureDigital is a trademark of Matsushita Electric Industrial Co.Ltd., SanDisk Corporation and Toshiba Corporation.

SanDisk is a licensee of the SD and miniSD trademarks.

xD-Picture Card is a trademark of Fujifilm Co.Ltd., Toshiba Corporation and Olympus Optical Co. Ltd.

Memory Stick Duo and MagicGate are trademarks of Sony Corporation.

Each company whose software title is mentioned in this manual has a Software License Agreement specific to its proprietary programs.

All other brand and product names mentioned in this User's Guide, the Software User's Guide, and the Network User's Guide are registered trademarks of their respective companies.

11 Troubleshooting and routine maintenance

Troubleshooting

IMPORTANT

For technical help, you must call the country where you bought the MFC. Calls must be made **from within** that country.

Error messages

As with any sophisticated office product, errors may occur. If this happens, your MFC identifies the problem and displays an error message. The most common error messages are shown below.

You can correct most problems by yourself. If you need additional help, the Brother Solutions Center offers latest FAQs and troubleshooting tips.

Visit us at <http://solutions.brother.com>.

ERROR MESSAGES		
ERROR MESSAGE	CAUSE	ACTION
Comm. Error	Poor phone line quality caused a communication error.	Try the call again. If the problem continues, call the telephone company and ask them to check your phone line.
Connection Fail	You tried to poll a fax machine that is not in Polled Waiting mode.	Check the other fax machine's polling setup.
Cover is Open	The scanner cover is not closed completely.	Lift the scanner cover and then close it again.
Data Remaining	Print data remains in the MFC's memory.	Re-start printing from your computer.
	Print data remains in the MFC's memory. The USB cable was unplugged while the computer was sending the data to the MFC.	Press Stop/Exit . The MFC will cancel the job and eject the page that is being printed.
Disconnected	The other person or other person's fax machine stopped the call.	Try to send or receive again.

ERROR MESSAGES		
ERROR MESSAGE	CAUSE	ACTION
DR Mode in Use	The MFC is set to Distinctive Ring mode. You can not change the Receive Mode from Manual to another mode.	Set Distinctive Ring to Off. (See <i>Turning off the Distinctive Ring</i> on page A-4.)
High Temperature	The print head is too warm.	Allow the MFC to cool down.
Ink Empty	One or more of the ink cartridges is empty. The MFC will stop all print operations. While memory is available, black and white faxes will be received into memory. If a sending machine has a color fax, the MFC's 'handshake' will request that the fax be sent as black and white. If the sending machine has the ability to convert it, the color fax will be received into memory as a black and white fax.	Replace the ink cartridges. (See <i>Replacing the ink cartridges</i> on page 11-25.)
Low Temperature	The print head is too cold.	Allow the MFC to warm up.
Media Error (MFC-5840CN only)	The media card is either corrupted, improperly formatted, or there is a problem with the media drive.	Re-insert the card firmly into the slot to make sure it is in the proper position. If the error remains, check the media drive by inserting another media card that you know is working.
Near Empty	One or more of the ink cartridges are running out of ink. If a sending machine has a color fax, the MFC's 'handshake' will request that the fax be sent as black and white. If the sending machine has the ability to convert it, the color fax will be received into memory as a black and white fax.	Order a new ink cartridge. (See <i>Ordering accessories and supplies</i> on page ii.)
No Cartridge	An ink cartridge is not properly installed.	Take out the ink cartridge and put it in again seating it properly. (See <i>Replacing the ink cartridges</i> on page 11-25.)
No File (MFC-5840CN only)	The media card in the media drive does not contain a .JPG file.	Re-insert the correct media.
(For MFC-5440CN) No Paper Fed (For MFC-5840CN) No Paper Fed #1 No Paper Fed #2	The MFC is out of paper.	Add paper, and then press Black Start or Color Start .
	The paper is jammed in the MFC.	See <i>Printer jam or paper jam</i> on page 11-6.
	The paper loaded in Tray#2 is the wrong size or type. (MFC-5840CN only)	Check the paper loaded in Tray#2. You can only use plain paper sizes Letter, Legal, A4, Executive or B5 in this way.

ERROR MESSAGES		
ERROR MESSAGE	CAUSE	ACTION
No Response/Busy	The number you dialed does not answer or is busy.	Verify the number and try again.
Not Registered	You tried to access a Speed Dial number that is not programmed.	Set up the Speed Dial number. (See <i>Storing Speed-Dial numbers</i> on page 5-1.)
Document Jam	The document scanned from ADF was longer than about 35.4 inches.	See <i>Using the automatic document feeder (ADF)</i> on page 1-7.
	The document is jammed in the MFC.	See <i>Document jams</i> on page 11-5.
Out of Memory	The MFC's memory is full.	(Fax sending or copy operation in process) Press Stop/Exit and wait until the other operations in progress finish and then try again. —OR— Clear the data in the memory. To gain extra memory, you can turn off Fax Storage. (See <i>Setting Fax Storage</i> on page 6-3.) —OR— Print the faxes that are in the memory. (See <i>Printing a fax from the memory</i> on page 4-5.) (Printing operation in process) Reduce print resolution.
Paper Jam	Paper is jammed in the MFC.	(See <i>Printer jam or paper jam</i> on page 11-6.)
Wrong Paper Size	Paper is not the correct size.	Reload the correct size of paper (Letter, Legal or A4), and then press Black Start or Color Start .

ERROR MESSAGES		
ERROR MESSAGE	CAUSE	ACTION
Unable to Change	The MFC has a mechanical problem.	<p>Open the scanner cover and remove any foreign obstacles from inside the MFC. If the error message continues, please follow the steps below before disconnecting the MFC so you will not lose any important messages. Then, disconnect the MFC from the power source for several minutes (which will erase all faxes), and then reconnect it.</p> <p>Check whether the MFC has faxes in the memory</p> <ol style="list-style-type: none"> 1. Press Menu/Set, 9, 0, 1. 2. If the MFC has no faxes, disconnect the MFC from the power source for several minutes and then reconnect it. <p>—OR—</p> <p>If faxes are present, you can transfer them to another fax machine. Go to Step 3.</p> <p>—OR—</p> <p>You can forward the faxes to your PC. Please see Transfer faxes to your PC.</p> <p>Transfer faxes to another fax machine</p> <p>If you have not set up your Station ID, you cannot enter fax transfer mode.</p> <ol style="list-style-type: none"> 3. Enter the fax number to which faxes will be forwarded. 4. Press Black Start. 5. After the faxes are transferred, disconnect the MFC from the power source for several minutes and then reconnect it. <p>You can transfer the Fax Journal report to another fax machine by pressing Menu/Set, 9, 0, 2 in Step 1.</p> <p>Transfer faxes to your PC</p> <p>You can move the faxes from your MFC's memory to your PC.</p> <ol style="list-style-type: none"> 1. Press Menu/Set, 2, 5, 1. 2. Using ▲ or ▼, select PC Fax Receive, and then press Menu/Set. The LCD will ask if you want to transfer a fax to your PC. 3. To transfer all faxes to your PC, press 1. <p>—OR—</p> <p>To keep all faxes in the MFC's memory, press 2.</p> 4. After the faxes are transferred, disconnect the MFC from the power source for several minutes and then reconnect it. (For details see <i>Using Brother PC-FAX software</i> on page 5-1 in Software User's Guide on the CD-ROM.)
Unable to Clean	—OR— A foreign obstacle, such as a clip or ripped paper, is in the MFC.	
Unable to Init.		
Unable to Print		
Unable to Scan		

Document jams

If the document is jammed, follow the steps below.

Document is jammed in the top of the ADF unit.

- 1 Take out any paper from the ADF that is not jammed.
- 2 Open the ADF cover.
- 3 Pull the jammed document out to the right or left.

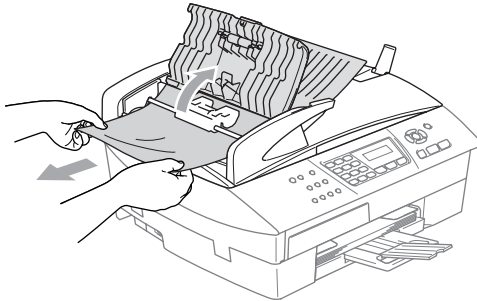

- 4 Close the ADF cover.
Press **Stop/Exit**.

Document is jammed inside the ADF unit.

- 1 Take out any paper from the ADF that is not jammed.
- 2 Lift the document cover.
- 3 Pull the jammed document out to the right.

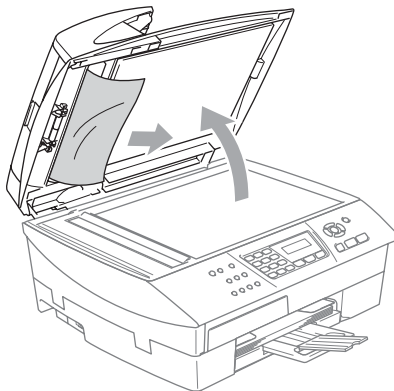

- 4 Close the document cover.
Press **Stop/Exit**.

Printer jam or paper jam

Remove the jammed paper depending on where it is jammed in the MFC.

Paper is jammed inside the paper tray

- 1 Pull the paper tray out of the MFC.

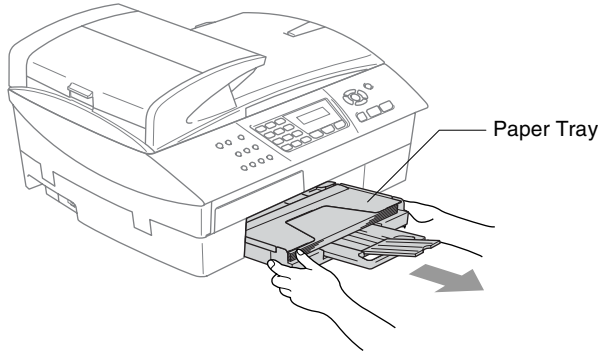

- 2 Pull out the jammed paper to remove it.

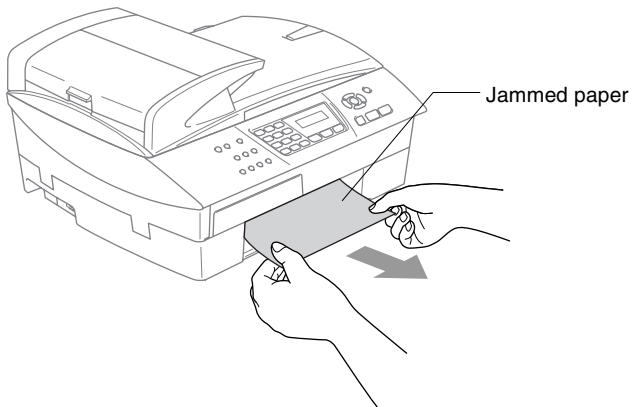

Paper is jammed inside the MFC

- 1 Remove the Jam Clear Cover. Pull the jammed paper out of the MFC.

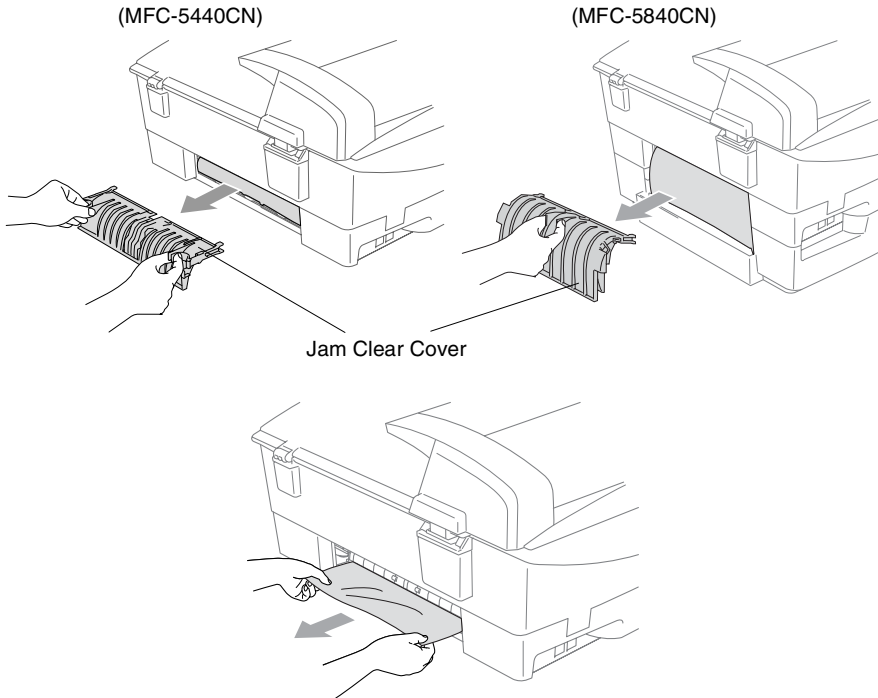

- 2 Re-insert the Jam Clear Cover.
- 3 If you can not pull out the jammed paper, lift the scanner cover from the right-hand side of the MFC until it locks securely into the open position.

4 Remove the jammed paper.

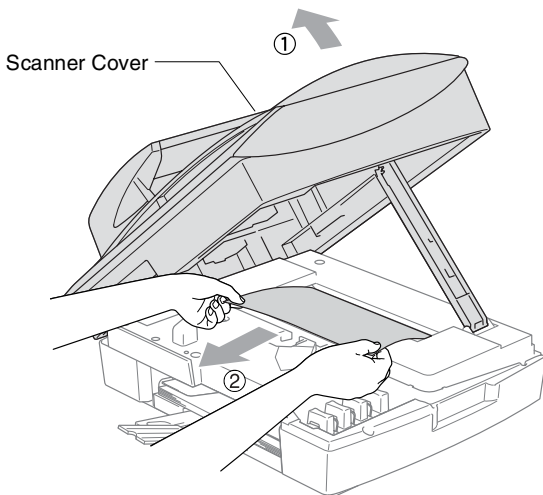

 If the paper is jammed underneath the print head, disconnect the MFC from the power source so you can move the print head and take out the paper.

5 Lift the scanner cover to release the lock. Gently push the scanner cover support down and close the scanner cover.

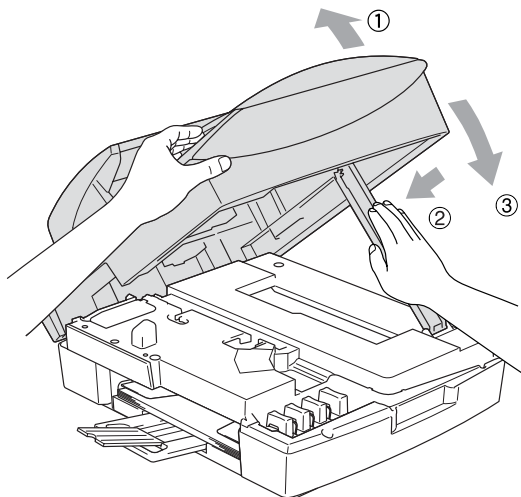

If you are having difficulty with your MFC

If you think there is a problem with your MFC, check the chart below and follow the troubleshooting tips.

The Brother Solutions Center offers the latest FAQs and troubleshooting tips.

Visit us at <http://solutions.brother.com>.

DIFFICULTY	SUGGESTIONS
Printing	
No printout	Check the interface cable connection on both the MFC and your computer.
	Check that the MFC is plugged in and On/Off key turned On.
	One or more ink cartridges are empty. (See <i>Replacing the ink cartridges</i> on page 11-25.)
	Check to see if the LCD is showing an error message. (See <i>Error messages</i> on page 11-1.)
Poor quality print.	Check the print quality. (See <i>Checking the print quality</i> on page 11-16.)
	Make sure the Printer Driver or Paper Type setting in the menu matches the type of paper you are using. (See <i>Media Type</i> on page 1-8 in Software User's Guide on the CD-ROM and <i>Setting the Paper Type</i> on page 2-3.)
	Make sure your ink cartridges are fresh. Cartridges remain fresh for up to two years if kept in their original packaging, after that the ink may become clogged. Cartridge expiration dates are printed on the package.
	Try using the recommended types of paper. (See <i>About paper</i> on page 1-10.)
	The recommended environment for your MFC is between 68°F to 91°F.
White horizontal lines appear in text or graphics.	Clean the print head. (See <i>Cleaning the print head</i> on page 11-15.)
	Try using the recommended types of paper. (See <i>About paper</i> on page 1-10.)
	If horizontal bands appear when using plain paper, use the 'Enhanced Normal Printing' mode to help avoid banding on some types of plain paper. In the printer driver 'Basic' tab, click 'Settings', and check 'Enhanced Normal Printing'. If you continue to have horizontal bands, change the Media Type selection to 'Slow Drying Paper' in the printer driver 'Basic' tab to help enhance the print quality.
MFC prints blank pages.	Clean the print head. (See <i>Cleaning the print head</i> on page 11-15.)
Characters and lines are stacked.	Check the printing alignment. (See <i>Checking the printing alignment</i> on page 11-18.)
Printed text or images are skewed.	Make sure the paper is loaded properly in the paper tray and the paper side guide is adjusted correctly. (See <i>How to load paper, envelopes and post cards</i> on page 1-15.)
Smudged stain at the top center of the printed page.	Make sure the paper is not too thick or not curled. (See <i>About paper</i> on page 1-10.)

DIFFICULTY	SUGGESTIONS
Printing (Continued)	
Printing appears dirty or ink seems to run.	Make sure you are using the proper types of paper. (See <i>About paper</i> on page 1-10.) Don't handle the paper until the ink is dry.
Stains appear on the reverse side or at the bottom of the page.	Make sure the Printer Platen is not dirty with ink. (See <i>Cleaning the MFC printer platen</i> on page 11-24.)
	Make sure you are using the paper support flap. (See <i>How to load paper, envelopes and post cards</i> on page 1-15.)
There are some dense lines.	Check 'Reverse Order' in the Basic tab of the printer driver.
Printouts are wrinkled.	In the printer driver 'Basic' tab, click the 'Settings', and uncheck the 'Bi-Directional Printing'.
Cannot perform '2 in 1 or 4 in 1' printing.	Check that the Paper Size setting in the application and in the printer driver are the same.
Print speed is too slow.	Changing the Printer Driver setting may improve the print speed. Highest resolution needs longer data processing, transfer and printing time. Try the other settings of quality in the printer driver 'Basic' tab. Also, click the 'Settings' tab, and make sure you uncheck the True2Life®.
	Borderless printing is slower than normal printing. If you want to print more quickly, set the Borderless feature off. (See <i>Borderless</i> on page 9-12.)
True2Life® is not working properly.	If the image data is not full color in your application (Such as 256 color), True2Life® will not work. Please use at least 24 bit color data with the True2Life® feature.
MFC feeds multiple pages	Make sure the paper is loaded properly in the paper tray. (See <i>How to load paper, envelopes and post cards</i> on page 1-15.)
	Check that more than two types of paper are not loaded in the paper tray at any one time.
Printed pages are not stacked neatly.	Make sure you are using the paper support flap. (See <i>How to load paper, envelopes and post cards</i> on page 1-15.)
MFC does not print from Paint Brush.	Try setting the Display setting to '256 colors.'
MFC does not print from Adobe Illustrator.	Try to reduce the print resolution.
Printing Received Faxes	
Condensed print and white streaks across the page or the top and bottom of sentences are cut off.	This can be caused by static or interference on the telephone line. You can make a copy using the Black Start key to see if the same problem occurs. If the copy looks good then the problem is probably the phone line and not your MFC.
Vertical black lines when receiving.	The sender's scanner may be dirty. Ask the sender to make a copy to see if the problem is with the sending machine. Try receiving from another fax machine.
Received color fax prints only in black and white.	Replace the color ink cartridges that are empty or nearly empty, and then ask the other person to send the color fax again. (See <i>Replacing the ink cartridges</i> on page 11-25.) Check that Fax Storage is not turned on. (See <i>Setting Fax Storage</i> on page 6-3.)
Left and Right margins are cut off or a single page is printed on two pages.	Turn on Auto Reduction. (See <i>Printing a reduced incoming fax (Auto Reduction)</i> on page 4-5.)

DIFFICULTY	SUGGESTIONS
Phone Line or Connections	
Dialing does not work. (No dial tone)	Check the MFC is plugged in.
	Check for a dial tone. If possible, call your MFC to hear it answer. If there is still no answer, check the telephone line cord connection and make sure all telephone connections are secured. If there is no ringing when you call your MFC, ask your telephone company to check the line.
	Change Tone/Pulse setting. (See <i>Setting Tone and Pulse dialing mode</i> on page 2-1.)
Receiving Faxes	
Cannot receive a fax	Make sure the MFC is in the correct receiving mode for your setup. (See <i>Basic receiving operations</i> on page 4-1.)
	If you frequently encounter interference on the phone line, try changing the menu setting of Compatibility to <i>Basic</i> or <i>Normal</i> . (See <i>Compatibility</i> on page 11-14.)
Sending Faxes	
Cannot send a fax	Make sure that the Fax  key is illuminated. (See <i>How to enter Fax mode</i> on page 3-1.)
	Ask the other party to check that receiving machine has paper.
	Print the Transmission Verification Report and check for an error. (See <i>Printing reports</i> on page 7-3.)
Transmission Verification Report says 'Result:NG' or 'Result:ERROR'.	There is probably temporary noise or static on the line. Try sending the fax again. If you send a PC FAX message and get 'Result:NG' on the Transmission Verification Report, your MFC may be out of memory.
	To gain extra memory, you can turn off Fax Storage (see <i>Setting Fax Storage</i> on page 6-3), print fax messages in memory (see <i>Printing a fax from the memory</i> on page 4-5) or cancel a Delayed Fax or Polling Job (see <i>Canceling a scheduled job</i> on page 3-11). If the problem continues, ask the telephone company to check your phone line.
If you frequently get transmission error with possible interference on the phone line, try to change the menu setting of Compatibility to <i>Basic</i> or <i>Normal</i> . (See <i>Compatibility</i> on page 11-14.)	
Poor sending quality.	Try changing your resolution to <i>Fine</i> or <i>S.Fine</i> . Make a copy to check your MFC's scanner operation.
Vertical black lines when sending.	If the copy you made shows the same problem, your scanner is dirty. (See <i>Cleaning the scanner</i> on page 11-23.)

DIFFICULTY	SUGGESTIONS
Handling Incoming Calls	
MFC 'Hears' Voice as CNG Tone.	If your MFC is set to Easy Receive On, it is more sensitive to sounds. Your MFC may mistakenly interpret certain voices or music on the line as a calling fax machine and respond with fax receiving tones. Deactivate the fax by pressing Stop/Exit . Try avoiding this problem by turning Easy Receive to Off. (See <i>Easy Receive</i> on page 4-4.)
Transferring a Fax Call to the MFC.	If you answered on an extension phone, press your Fax Receive Code (default setting is (✕)51). When your MFC answers, hang up.
Custom features on a single line.	If you have Call Waiting, Call Waiting/Caller ID, Ring Master, Voice Mail, an alarm system or any other custom feature on a single phone line with your MFC, it may create a problem sending or receiving faxes. For example: If you are sending or receiving a fax message while a custom feature signal comes through on the line, the signal can temporarily interrupt or disrupt the faxes. Brother's ECM feature should help overcome this problem. This condition is related to the telephone system industry and is common to all devices that send and receive data on a single, shared line with custom features. If avoiding a slight interruption is crucial to your business, we recommend a separate phone line with no custom features.
Copying Difficulties	
Cannot make a copy	Make sure that the Copy  key is illuminated. (See <i>Enter Copy mode</i> on page 8-1.)
Vertical streaks appear in copies	Sometimes you may see vertical streaks on copies. Clean the scanner. (See <i>Cleaning the scanner</i> on page 11-23.)
Poor copy results	Try using the scanner glass. (See <i>Using the scanner glass</i> on page 1-9.)
Scanning Difficulties	
TWAIN/WIA errors appear while scanning.	Make sure the Brother TWAIN/WIA driver is selected as the primary source. In PaperPort®, click Scan in the File menu and select the Brother TWAIN/WIA driver.
Poor scanning results	Try using the scanner glass. (See <i>Using the scanner glass</i> on page 1-9.)
Software Difficulties	
Cannot install software or print	Run the Repair MFL-Pro Suite program on the CD-ROM. This program will repair and reinstall the software.
'Device Busy'	Make sure the MFC is not showing an error message on the LCD.
'Connect Failure'	<p>If the MFC is not connected to your PC and you have loaded the Brother software, the PC will show 'MFC Connect Failure' each time you restart Windows®. You can ignore this message or you can turn it off as follows. Double-click "\\tool\warnOff.REG" from the supplied CD-ROM.</p> <p>To turn it back on, double-click "\\tool\WarnOn.REG" from the supplied CD-ROM.</p> <p>The Scan key on the MFC's control panel will not work unless you restart your PC with the MFC connected.</p>

DIFFICULTY	SUGGESTIONS
PhotoCapture Center™ Difficulties (MFC-5840CN only)	
Removable Disk does not work properly.	<p>a) Have you installed the Windows® 2000 update? If not, do the following:</p> <ol style="list-style-type: none"> 1. Disconnect the USB cable. 2. Install the Windows® 2000 update. Please see the Quick Setup Guide. After the installation the PC will be automatically restarted. 3. Wait about 1 minute after you reboot the PC, and then connect the USB cable. <p>b) Take out the media card and put it back in again.</p> <p>c) If you have tried "Eject" from within Windows®, you must take out the media card before you continue.</p> <p>d) If an error message appears when you try to eject the media card, it means the card is being accessed. Wait a while and then try again.</p> <p>e) If all of the above do not work, please turn off your PC and MFC, and then turn them on again. (You will have to unplug the power cord of the MFC to turn it off.)</p>
Cannot access Removable Disk from Desktop icon.	Make sure you have inserted the media card into the media slot.
Network Difficulties	
I cannot print over the Network	<p>Make sure that your MFC is powered on and is On Line and in Ready mode. Print Network Configuration list. (See <i>Printing reports</i> on page 7-1.) Then the current settings of the network are printed. Reconnect the LAN cable to the hub to verify that the cabling and network connections are good. If possible, try connecting the MFC to a different port on your hub using a different cable. If the connections are good, the machine shows LAN Active for 2 seconds.</p>

Compatibility

If you are having difficulty sending or receiving a fax due to possible interference on the phone line, we recommend that you adjust the Equalization for compatibility. The MFC adjusts the modem speed for fax operations.

1 Press **Menu/Set, 2, 0, 1**.

2 Press **▲** or **▼** to select **Normal**,
Basic (or **High**).

Press **Menu/Set**.

3 Press **Stop/Exit**.

Miscellaneous 1.Compatibility



- **Basic** reduces the default modem speed to 9600 bps. Unless interference is a recurring problem on your phone line, you may prefer to use it only when needed.
- **Normal** sets the modem speed at 14400 bps.
- **High** sets the modem speed at 33600 bps. (Default)

How to improve print quality

Cleaning the print head

To ensure good print quality, the MFC will regularly clean the print head. You can start the cleaning process manually if needed.

Clean the print head and ink cartridges if you get a horizontal line in the text or graphics on your printed pages. You can clean Black only or three colors at a time (Cyan/Yellow/Magenta), or all four colors at once.

Cleaning the print head consumes ink. Cleaning too often uses ink unnecessarily.

Caution

Do NOT touch the print head. Touching the print head may cause permanent damage and may void the print head's warranty.

- 1** Press **Ink**.
- 2** Press **▲** or **▼** to select **Cleaning**.
Press **Menu/Set**.
- 3** Press **▲** or **▼** to select **Black, Color** or **All**.
Press **Menu/Set**.

The MFC will clean the print head. When cleaning is finished, the MFC will go back to standby mode automatically.

 If you clean the print head at least five times and the print has not improved, call Brother Customer Service (see *Brother numbers* on page i).

Checking the print quality

If faded or streaked colors and text appear on your output, some of the nozzles may be clogged. You can check this by printing the Print Quality Check Sheet and looking at the nozzle check pattern.

- 1** Press **Ink**.
- 2** Press **▲** or **▼** to select `Test Print`.
Press **Menu/Set**.
- 3** Press **▲** or **▼** to select `Print Quality`.
Press **Menu/Set**.
- 4** Press **Color Start**.

The MFC begins printing the Print Quality Check Sheet.

- 5** Check the sheet to see if the quality is OK by following these steps:

Color block quality check

The LCD shows:

Is Quality OK?
1.Yes 2.No

- 6** Check the quality of the four color blocks on the sheet.
- 7** If all lines are clear and visible, press **1** (Yes), and go to step 10.
—OR—

If you can see missing short lines as shown below, press **2** (No).

OK

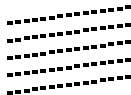

Poor



The LCD will ask you if the print quality is OK for black and three colors.

Black OK?
1.Yes 2.No

- 8** Press **2** (No) for Black or three colors with a problem.

The LCD shows:

Start Cleaning?
1.Yes 2.No

Press **1** (Yes).

The MFC will start cleaning the print head.

- 9** After cleaning is finished, press **Color Start**. The MFC will start printing the Print Quality Check Sheet again and then return to Step 5.

- 10** Press **Stop/Exit**.

If you still see missing ink in this Print Quality Check Sheet, repeat the cleaning and test print procedures at least five times. If ink is still missing after the fifth cleaning and test print, replace the ink cartridge for the clogged color. (Perhaps the ink cartridge was in your MFC over six months or the expiration date written on the cartridge package has passed. Or, the ink may not have been stored properly before use.)

After replacing the ink cartridge, check it by printing another Print Quality Check Sheet. If the problem still exists, repeat the cleaning and test print procedures at least five times for the new ink cartridge. If ink is still missing, call Brother Customer Service (see *Brother numbers* on page i).

! Caution

Do NOT touch the print head. Touching the print head may cause permanent damage and may void the print head's warranty.



When a print head nozzle is clogged, the printed sample looks like this.



After the print head nozzle is cleaned, the horizontal lines are gone.

Checking the printing alignment

You should rarely need to adjust the printing alignment however, if after transporting the machine your printed text becomes blurred or images become faded then adjustment may need to be made.

- 1 Press **Ink**.
- 2 Press **▲** or **▼** to select `Test Print`.
Press **Menu/Set**.
- 3 Press **▲** or **▼** to select `Alignment`.
Press **Menu/Set**.

- 4 Press **Black Start** or **Color Start**.

The MFC begins printing the Alignment Check Sheet.

The LCD shows:

```
Is Alignment OK?  
1.Yes 2.No
```

- 5 Check the 600 dpi and 1200 dpi test prints to see if number 5 most closely matches number 0. If the number 5 sample of both the 600 dpi and 1200 dpi are the best matches, press **1** (Yes) to finish Alignment Check, and go to Step 8.

—OR—

If another test print number is a better match for either 600 dpi or 1200 dpi, press **2** (No) to select it.

- 6 For 600 dpi, press the number of the test print that most closely matches the number 0 sample (1-8).
- 7 For 1200 dpi, press the number of the test print that most closely matches the number 0 sample (1-8).
- 8 Press **Stop/Exit**.

```
600dpi Adjust  
Select Best # 5
```

```
1200dpi Adjust  
Select Best # 5
```

Checking the ink volume

You can check the ink that is left in the cartridge.

- 1 Press **Ink**.
- 2 Press ▲ or ▼ to select **Ink Volume**.
Press **Menu/Set**.

- 3 Press ▲ or ▼ to select the color you want to check.



The LCD shows the ink volume.

- 4 Press **Stop/Exit**.



You can check the ink volume from your computer. (See *MFC Remote Setup* (not available for MFC-210C) on page 4-1 in Software User's Guide on the CD-ROM or *MFC Remote Setup* (Mac OS® X 10.2.4 or greater) (not available for MFC-210C) on page 8-43 in Software User's Guide on the CD-ROM.)

Packing and shipping the MFC

Whenever you transport the MFC, use the packing materials that came with your MFC. If you do not pack the MFC properly, you could void your warranty.

! Caution

It is important to allow the MFC to 'park' the print head after a print job. Listen carefully to the MFC before disconnecting it from the power source to ensure that all mechanical noise has stopped. Not allowing the MFC to complete this parking process may lead to print problems and possible damage to the print head.

- 1 Lift the scanner cover from the right-hand side of the MFC until it locks securely into the open position.
- 2 Remove all the ink cartridges and attach the protective parts. (See *Replacing the ink cartridges* on page 11-25.)

When attaching the protective parts, make sure it clips into place as shown in the diagram.

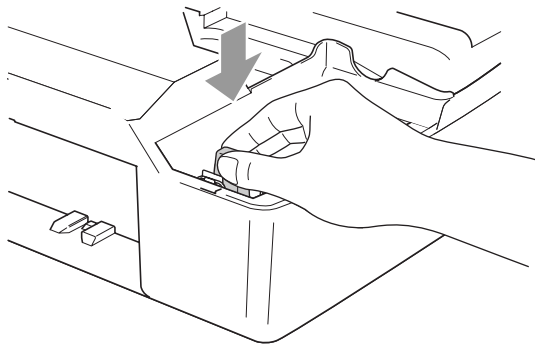

! Caution

If you are not able to find the protective parts, do NOT remove the ink cartridges before shipping. It is essential that the MFC be shipped with either the protective parts or the ink cartridges in position. Shipping without them will cause damage to your MFC and may void your warranty.

- 3** Lift the scanner cover to release the lock. Gently push the scanner cover support down and close the scanner cover.

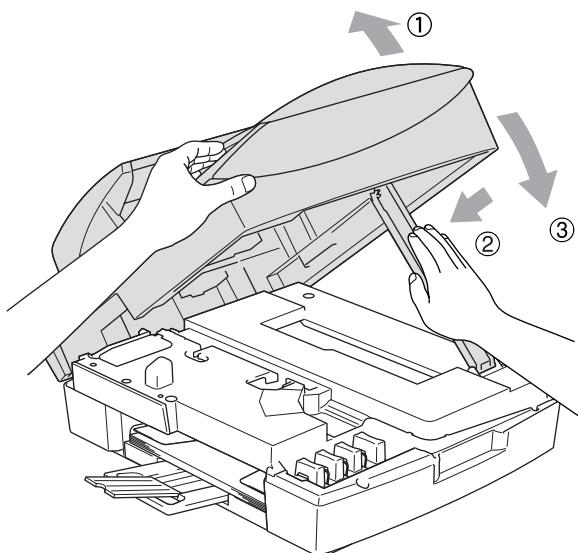

- 4** Unplug the MFC from the telephone wall jack and remove the telephone line cord from MFC.
- 5** Unplug the MFC from the AC power outlet.
- 6** Unplug the USB cable or LAN cable from the MFC, if it is connected.
- 7** Wrap the MFC in the bag and place it in the original carton with the original packing material.

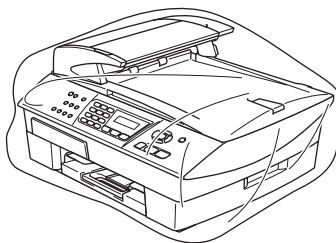

- 8** Pack the printed materials in the original carton as shown below. Do not pack the used ink cartridges in the carton.

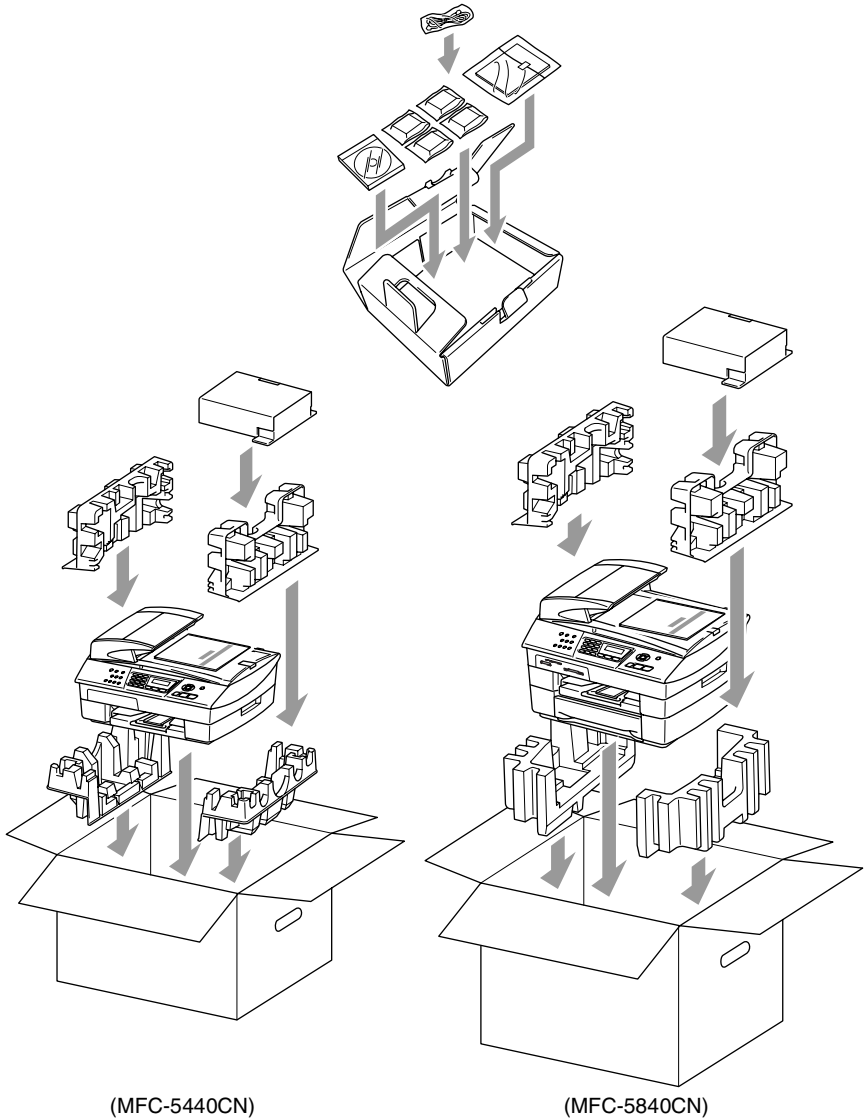

 If you are returning your machine to Brother as part of the Exchange Service, pack *only* the MFC. Keep all separate parts and printed materials to use with your “Exchange” machine.

- 9** Close the carton.

Routine maintenance

Cleaning the scanner

Unplug the MFC and lift the document cover. Clean the scanner glass with isopropyl alcohol on a soft lint-free cloth.

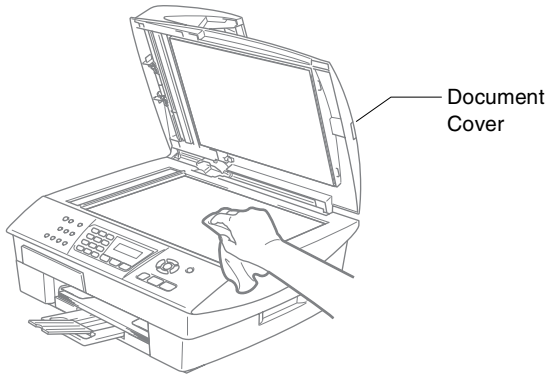

Clean the white bar and the glass strip under the film with isopropyl alcohol on a lint-free cloth.

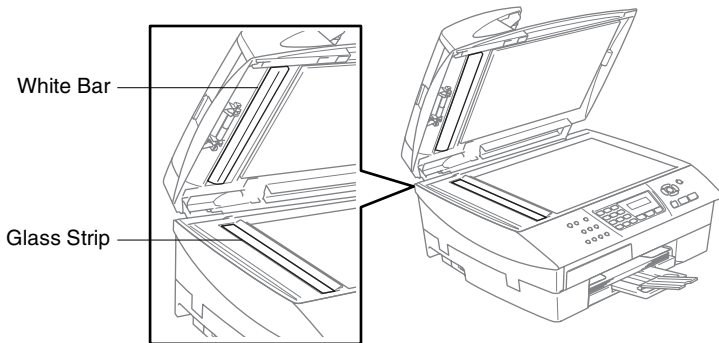

Cleaning the MFC printer platen

- Be careful not to touch the paper feed star wheels or encoder film.
- Be sure to unplug the MFC from the AC power outlet before cleaning the printer platen.
- If ink is scattered on or around the printer platen be sure to wipe it off with a soft, dry, lint-free cloth.

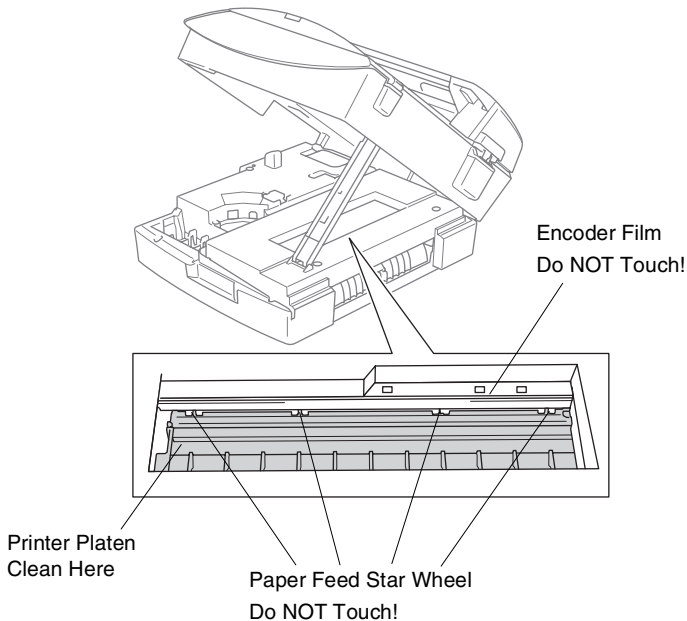

Replacing the ink cartridges

Your MFC is equipped with an ink dot counter. The ink dot counter automatically monitors the level of ink in each of the four cartridges. When the MFC detects an ink cartridge is running out of ink, the MFC will notify you with a message on the LCD.

The LCD will inform you which ink cartridge is low or needs replacing. Be sure to follow the LCD prompts to replace the ink cartridges in the correct order.

Even though the MFC informs you that an ink cartridge is empty, there will be a small amount of ink remaining in the ink cartridge. It is necessary to keep some ink in the ink cartridge to prevent air from drying out and damaging the print head assembly.

- 1** Lift the scanner cover from the right-hand side of the MFC until it locks securely into the open position.

If one or more ink cartridges are empty, for example Black, the LCD shows `Ink Empty Black and Cover is Open`.

- 2** Pull the ink cartridge hook toward you and remove the ink cartridge for the color shown on the LCD.

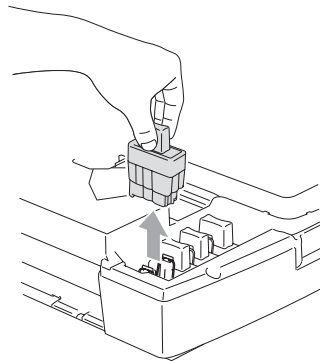
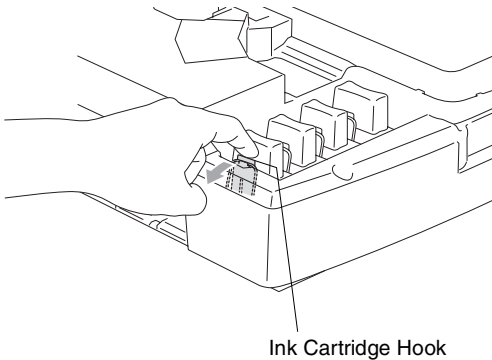

- 3** Open the new ink cartridge bag for the color shown on the LCD, and then take out the ink cartridge.

4 Remove the cartridge covers.

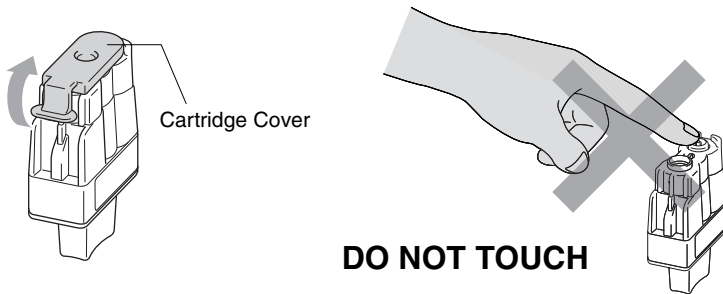

⊘ Do not touch the area shown in the illustration above.

 If the cartridge cover comes off when you open the bag the cartridge will not be damaged.

5 Each color has its own correct position. Keep the ink cartridge in an upright position when you insert it into slot. Press down on the ink cartridge until the hook snaps over it.

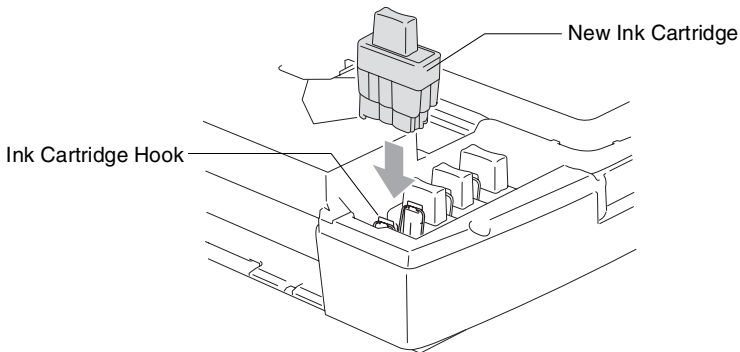

6 Lift the scanner cover to release the lock. Gently push the scanner cover support down and close the scanner cover.

7 If you replaced an ink cartridge while `Near Empty` was displayed on the LCD, the LCD may ask you to verify that it was a brand new one. Example: `Did You Change Blck? 1.Yes 2.No`. For each *new* cartridge you installed, press **1** on the dial pad to automatically reset the ink dot counter for that color. If the ink cartridge you installed is not a brand new one, please be sure to select **2**.



If you wait until `Ink Empty` message is displayed on the LCD, the MFC will automatically reset the ink dot counter.



If the `Install` message is on the display after you have installed ink cartridges, check that the ink cartridges are installed properly.

⚠ WARNING

If ink gets in your eyes, irrigate them with water immediately and call a doctor if you are concerned.

 **Caution**

- Do not remove ink cartridges if you do not need to replace them. If you do so, it may reduce the ink quantity and the MFC will not know the quantity of ink left in the cartridge.
- Do not touch the cartridge insertion slots. If you do so, the ink may stain your skin.
- If ink stains your skin or clothing, wash with soap or detergent immediately.
- If you install an ink cartridge in the wrong color position, you must clean the print head several times before you start printing (after correcting the cartridge installation) because the colors were mixed.
- Once you open an ink cartridge, install it in the MFC and use it up within six months of installation. Use unopened ink cartridges by the expiration date written on the cartridge package.
- Do not dismantle or tamper with the ink cartridge, this can cause the ink to leak out of the cartridge.
- Brother strongly recommends that you do not refill the ink cartridges provided with your machine. We also strongly recommend that you continue to use only Genuine Brother Brand replacement ink cartridges. Using or attempting to use potentially incompatible inks and/or cartridges in your machine may cause damage to the machine itself and/or it may result in unsatisfactory print quality. Our warranty coverage does not apply to any problem that was caused by the use of unauthorized third party ink and/or cartridges. To protect your investment and guarantee your print quality please continue to replace consumed ink cartridges with only Genuine Brother Branded Supplies.

A Appendix A

Setting up telephone services

Your MFC supports the Distinctive Ring and Caller ID subscriber telephone services that some telephone companies offer.



If you have Voice Mail, Call Waiting, Call Waiting/Caller ID, RingMaster, an answering service, an alarm system or other custom features on your telephone line, it may affect the way your MFC works. (See *Custom features* on page 1-22 and *Custom features on a single line* on page 11-12.)

If you have Voice Mail on your phone line, please read the following carefully.

Distinctive Ring

Brother uses the term 'Distinctive Ring' but different telephone companies have other names for this service such as SmartRing, RingMaster, Teen-Ring, Indent-a-Call or Indent-a-Ring.

What does your telephone company's 'Distinctive Ring' do?

Your telephone company's Distinctive Ring service allows you to have more than one number on the same phone line. **If you need more than one phone number, it is cheaper than paying for an extra line.** Each phone number has its own distinctive ring pattern, so you will know which phone number is ringing. This is one way you can have a separate phone number for your MFC.



Please call your telephone company for availability and rates.

What does Brother's 'Distinctive Ring' do?

The Brother MFC has a Distinctive Ring feature that allows you to use your MFC to take full advantage of the telephone company's Distinctive Ring service. The new phone number on your line can just receive faxes.



You must pay for your telephone company's Distinctive Ring service before you program the MFC to work with it.

Do you have Voice Mail?

If you have Voice Mail on the phone line that you will install your new MFC on, *there is a strong possibility that Voice Mail and the MFC will conflict with each other while receiving incoming calls.* **However, the Distinctive Ring feature allows you to use more than one number on your line, so both Voice Mail and the MFC can work together without any problems.** If each one has a separate phone number, neither will interfere with the other's operations.





If you decide to get the Distinctive Ring service from the telephone company, you will need to follow the directions below to 'register' the new Distinctive Ring pattern they give you. This is so your MFC can recognize its incoming calls.



You can change or cancel the Distinctive Ring pattern at any time. You can switch it off temporarily, and turn it back on later. When you get a new fax number, make sure you reset this feature.

Before you choose the ring pattern to register

You can only register one Distinctive Ring pattern with the MFC. Some ring patterns cannot be registered. The ring patterns below are supported by your Brother MFC. Register the one your telephone company gives you.

Ring Pattern	Rings	
1	long-long	
2	short-long-short	
3	short-short-long	
4	very long (normal pattern)	

 If the ring pattern you received is not on this chart, **please call your telephone company and ask for one that is shown.**

- The MFC will only answer calls to its registered number.
- The first two rings are silent on the MFC. This is because the fax must «listen» to the ring pattern (to compare it to the pattern that was ‘registered’). (Other telephones on the same line will ring.)
- If you program the MFC properly, it will recognize the registered ring pattern of the ‘fax number’ within 2 ring patterns and then answer with a fax tone. When the ‘voice number’ is called, the MFC will not answer.

Registering the Distinctive Ring pattern

Very important!

After you have set the Distinctive Ring feature to ON, the receive mode is set to `Manual` automatically. Unless you have a TAD or Voice Mail set up on the Distinctive Ring number, `Manual` mode means you must answer all the calls yourself. You can not change the receive mode to another mode while the Distinctive Ring is set to on.

- 1 Press **Menu/Set, 2, 0, 2.**
- 2 Press **▲** or **▼** to select `Set.`

Miscellaneous 2.Distinctive

- 3 Press **▲** or **▼** to select the stored ring pattern you want to use.
Press **Menu/Set.**

(You will hear each pattern as you scroll through the four patterns. Make sure you choose the pattern that the telephone company gave you.)

- 4 Press **Stop/Exit.** Distinctive Ring is now set to on.

Turning off the Distinctive Ring

- 1 Press **Menu/Set, 2, 0, 2.**
- 2 Press **▲** or **▼** to select `Off.`
Press **Menu/Set.**

Miscellaneous 2.Distinctive

- 3 Press **Stop/Exit.**



If you turn off Distinctive Ring, the MFC will stay in `Manual` receive mode. You will need to set the Receive Mode again. (See *To select or change your Receive Mode* on page 4-2.)

Caller ID



The Caller ID feature lets you use the Caller ID subscriber service offered by many local telephone companies. This service displays the telephone number, or name if it is available, of your caller as the line rings.

After a few rings, the LCD shows the telephone number of your caller (and name, if available). Once you pick up the handset, the Caller ID information disappears from the LCD, but the call information remains stored in the Caller ID memory.

- You will see the first 16 characters of the number (or name).
- `Out of Area` display means call originated outside your Caller ID service area.
- `Private Call` display means the caller has intentionally blocked transmission of information.

You can print a list of Caller ID information received by your MFC. (See *Printing Caller ID List* on page A-6.)

Caller ID service varies with different carriers. Call your local telephone company to determine the kind of service available in your area.

Viewing Caller ID List

Caller ID memory stores information for up to thirty calls. When the thirty-first call comes in, information about the first call is erased. You can scroll through Caller ID information to review those calls made to your MFC.

1 Press **Menu/Set, 2, 0, 3.**

Miscellaneous 3.Caller ID

2 Press **▲** or **▼** to select `Display#`.

Press **Menu/Set**.

If the name was not received, it will not be displayed.

3 Press **▲** or **▼** to scroll through the Caller ID memory to select the Caller ID you want to view, and then press **Menu/Set**. The LCD shows the caller's name or number and the date and time of the call.

4 Press **◀** to return to the Caller ID listing.

—OR—

Press **Stop/Exit**.

Printing Caller ID List

1 Press **Menu/Set, 2, 0, 3.**

Miscellaneous 3.Caller ID

2 Press **▲** or **▼** to select

`Print Report`.

Press **Menu/Set**.

3 Press **Black Start** or **Color Start**.

4 After printing has finished, press **Stop/Exit**.

Advanced receiving operations

Operation from extension telephones

If you answer a fax call on an extension telephone, or an external telephone in the EXT. jack of the MFC, you can make your MFC take the call by using the Fax Receive Code. When you press the Fax Receive Code ***51**, the MFC starts to receive a fax. (See *Easy Receive* on page 4-4.)

If the MFC answers a voice call and pseudo/double-rings for you to take over, use the Telephone Answer Code **#51** to take the call at an extension phone. (See *Setting the F/T Ring Time (Fax/Tel mode only)* on page 4-3.)

If you answer a call and no one is on the line, you should assume that you're receiving a manual fax.

- Press ***51** and wait for the chirp or until the MFC's LCD displays *Receiving*, and then hang up.

Your caller will have to press **Start** to send the fax.

Fax/Tel mode when power key is On

When the MFC is in Fax/Tel mode, it will use the F/T Ring Time (pseudo/double-ringing) to alert you to pick up a voice call.

If you are at an extension phone, you'll need to lift the handset during the F/T Ring Time and then press **#51** between the pseudo/double rings. If no one is on the line, or if someone wants to send you a fax, send the call back to the MFC by pressing ***51**.

Fax/Tel mode when power key is Off

Fax/Tel mode does not work when the power button is off. The MFC will not answer telephone or fax calls and will keep ringing. If you are at an external or extension phone, lift the handset of the extension phone and talk. If you hear fax tones, hold the handset until *Easy Receive* activates your MFC. If the other party says they want to send you a fax, activate the MFC by pressing ***51**.

Using a cordless external handset

If your cordless telephone is connected to the EXT. jack on the MFC and you typically carry the cordless handset elsewhere, it is easier to answer calls during the Ring Delay. If you let the MFC answer first, you will have to go to the MFC so you can press **Hook** to transfer the call to the cordless handset.

Changing the remote codes

Remote Codes might not work with some telephone systems. The preset Fax Receive Code is ***51**. The preset Telephone Answer Code is **#51**.



If you are always disconnected when accessing your external TAD remotely, try changing the Fax Receive Code and Telephone Answer Code to another three-digit code (such as **###** and **999**).

- 1** If it is not illuminated in green, press  **(Fax)**.
- 2** Press **Menu/Set, 2, 1, 4**.
- 3** Press **▲** or **▼** to select **On** (or **Off**).
Press **Menu/Set**.
- 4** Enter the new Fax Receive Code.
Press **Menu/Set**.
- 5** Enter the new Telephone Answer Code.
Press **Menu/Set**.
- 6** Press **Stop/Exit**.

Setup Receive
4.Remote Code

Connecting an external device to your MFC

Connecting an external telephone

You can connect a separate telephone (or telephone answering device) directly to your MFC as shown in the diagram below.

Connect the telephone line cord to the jack labeled EXT. in the back of the MFC.

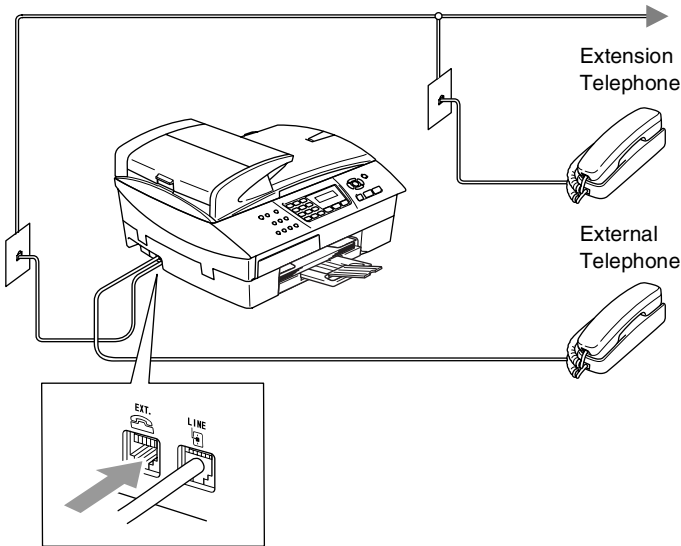

When you are using a TAD, the LCD shows Telephone.

Connecting an external telephone answering device (TAD)

Sequence

You may choose to connect an additional answering device. However, when you have an **external** TAD on the same telephone line as the MFC, the TAD answers all calls and the MFC “listens” for fax calling (CNG) tones. If it hears them, the MFC takes over the call and receives the fax. If it does not hear CNG tones, the MFC lets the TAD continue playing your outgoing message so your caller can leave you a voice message.

The TAD must answer within four rings (the recommended setting is two rings). The MFC cannot hear CNG tones until the TAD has answered the call, and with four rings there are only 8 to 10 seconds of CNG tones left for the fax “handshake”. Make sure you carefully follow the instructions in this guide for recording your outgoing message. We do not recommend using the toll saver feature on your external answering machine if it exceeds five rings.



If you do not receive all your faxes, reduce the Ring Delay setting on your external TAD.



If You Subscribe to your Telephone Company's Distinctive Ring Service:

You may connect an external TAD to a separate wall jack only if you subscribe to your telephone company's Distinctive Ring service, have registered the distinctive ring pattern on your MFC, and use that number as a fax number. The recommended setting is at least four rings on the external TAD when you have the telephone company's Distinctive Ring Service. You cannot use the Toll Saver setting.



If You Do Not Subscribe to Distinctive Ring Service:

You must plug your TAD into the EXT. jack of your MFC. If your TAD is plugged into a wall jack, both your MFC and the TAD will try to control the phone line. (See illustration below.)



Unless you are using Distinctive Ring, do not connect a TAD elsewhere on the same phone line.

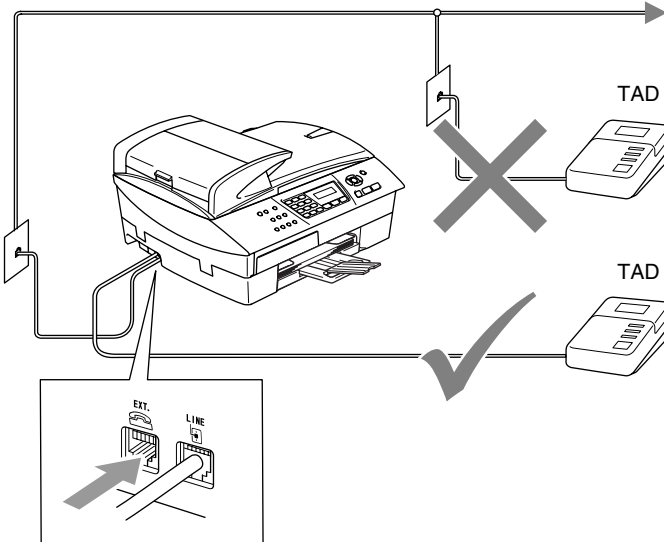

When you are using a TAD, the LCD shows *Telephone*.

Connections

The external TAD must be plugged into the back of the MFC, into the jack labeled EXT. Your MFC cannot work properly if you plug the TAD into a wall jack (unless you are using Distinctive Ring).

- 1** Plug the telephone line cord from the telephone wall jack into the back of the MFC, in the jack labeled LINE.
- 2** Plug the telephone line cord from your external TAD into the back of the MFC, in the jack labeled EXT. (Make sure this cord is connected to the TAD at the TAD's telephone *line* jack, and not its telephone jack.)
- 3** Set your external TAD to four rings or less. (The MFC's Ring Delay setting does not apply.)
- 4** Record the outgoing message on your external TAD.
- 5** Set the TAD to answer calls.
- 6** Set the Receive Mode to `External TAD`.
(See *Choosing the Receive Mode* on page 4-1.)

Recording outgoing message (OGM) on an external TAD

Timing is important in recording this message. The message sets up the ways to handle both manual and automatic fax reception.

- 1** Record 5 seconds of silence at the beginning of your message. (This allows your MFC time to listen for the fax CNG tones of automatic transmissions before they stop.)
- 2** Limit your speaking to 20 seconds.
- 3** End your 20-second message by giving your Fax Receive Code for people sending manual faxes. For example:
*"After the beep, leave a message or send a fax by pressing * 51 and Start."*



We recommend beginning your OGM with an initial 5-second silence because the MFC cannot hear fax tones over a resonant or loud voice. You may try omitting this pause, but if your MFC has trouble receiving, then you must re-record the OGM to include it.

Special line considerations

Roll over phone lines

A roll over phone system is a group of two or more separate telephone lines that pass incoming calls to each other if they are busy. The calls are usually passed down or “rolled over” to the next available phone line in a preset order.

Your MFC can work in a roll over system as long as it is the last number in the sequence, so the call cannot roll away. Do not put the MFC on any of the other numbers; when the other lines are busy and a second fax call is received, the fax call would be transferred to a line that does not have a fax machine. **Your MFC will work best on a dedicated line.**

Two-line phone system

A two-line phone system is nothing more than two separate phone numbers on the same wall outlet. The two phone numbers can be on separate jacks (RJ11) or combined into one jack (RJ14). Your MFC must be plugged into an RJ11 jack. RJ11 and RJ14 jacks may be equal in size and appearance and both may contain four wires (black, red, green, yellow). To test the type of jack, plug in a two-line phone and see if it can access both lines. If it can, you must separate the line for your MFC. (See *Easy Receive* on page 4-4.)

Converting telephone wall outlets

There are three ways to convert to an RJ11 jack. The first two ways may require assistance from the telephone company. You can change the wall outlets from one RJ14 jack to two RJ11 jacks. Or, you can have an RJ11 wall outlet installed and slave or jump one of the phone numbers to it.

The third way is the easiest: Buy a triplex adapter. You can plug a triplex adapter into an RJ14 outlet. It separates the wires into two separate RJ11 jacks (Line 1, Line 2) and a third RJ14 jack (Lines 1 and 2). If your MFC is on Line 1, plug the MFC into L1 of the triplex adapter. If your MFC is on Line 2, plug it into L2 of the triple adapter.

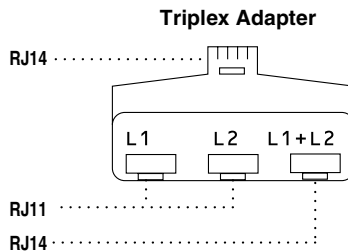

Installing MFC, external two-line TAD and two-line telephone

When you are installing an external two-line telephone answering device (TAD) and a two-line telephone, your MFC must be isolated on one line at both the wall jack and at the TAD. The most common connection is to put the MFC on Line 2, which is explained in the following steps. The back of the two-line TAD must have two telephone jacks: one labeled L1 or L1/L2, and the other labeled L2. You will need at least three telephone line cords, the one that came with your MFC and two for your external two-line TAD. You will need a fourth line cord if you add a two-line telephone.

- 1** Place the two-line TAD and the two-line telephone next to your MFC.
- 2** Plug one end of the telephone line cord for your MFC into the L2 jack of the triplex adapter. Plug the other end into the LINE jack on the back of the MFC.
- 3** Plug one end of the first telephone line cord for your TAD into the L1 jack of the triplex adapter. Plug the other end into the L1 or L1/L2 jack of the two-line TAD.
- 4** Plug one end of the second telephone line cord for your TAD into the L2 jack of the two-line TAD. Plug the other end into the EXT. jack on the left side of the MFC.

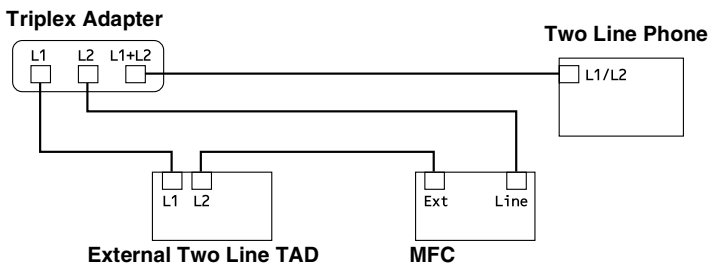

You can keep two-line telephones on other wall outlets as always. There are two ways to add a two-line telephone to the MFC's wall outlet. You can plug the telephone line cord from the two-line telephone into the L1+L2 jack of the triplex adapter. Or, you can plug the two-line telephone into the TEL jack of the two-line TAD.

Multi-line connections (PBX)

Most offices use a central telephone system. While it is often relatively simple to connect the MFC to a key system or a PBX (Private Branch Exchange), we suggest that you contact the company that installed your telephone system and ask them to connect the MFC for you. It is advisable to have a separate line for the MFC.

If the MFC is to be connected to a multi-line system, ask your installer to connect the unit to the last line on the system. This prevents the unit from being activated each time a telephone call is received.

If you are installing the MFC to work with a PBX

- 1** It is not guaranteed that the unit will operate properly under all circumstances with a PBX. Any cases of difficulty should be reported first to the company that handles your PBX.
- 2** If all incoming calls will be answered by a switchboard operator, it is recommended that the Receive Mode be set to *Manual*. All incoming calls should initially be regarded as telephone calls.

Custom features on your phone line

If you have Voice Mail, Call Waiting, Call Waiting/Caller ID, RingMaster, an answering service, an alarm system or other custom feature on one phone line it may create a problem with the operation of your MFC. (See *Custom features* on page 1-22 and *Custom features on a single line*. on page 11-12.)

B Appendix B

On-screen programming

Your MFC is designed to be easy to use with LCD on-screen programming using the navigation keys. User-friendly programming helps you take full advantage of all the menu selections your MFC has to offer.

Since your programming is done on the LCD, we have created step-by-step on-screen instructions to help you program your MFC. All you need to do is follow the instructions as they guide you through the menu selections and programming options.

Menu table

You can probably program your MFC without the User's Guide if you use the Menu table that begins on page B-3. These pages will help you understand the menu selections and options that are found in the MFC's programs.



You can program your MFC by pressing **Menu/Set**, followed by the menu numbers.

For example to set `Fax Resolution` to `Fine`:





Press **Menu/Set**, **2**, **2**, **2** and **▲** or **▼** to select `Fine`.

Press **Menu/Set**.

Memory storage

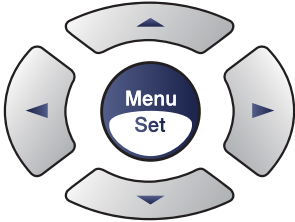
If there is a power failure, you will not lose your menu settings because they are stored permanently. Temporary settings (such as Contrast, Overseas Mode, and so on) will be lost. You may also have to reset the date and time.

Navigation keys

		Access the menu Go to the next menu level Accept an option
		Scroll through the current menu level
		Go back to the previous menu level
	Stop/Exit 	Exit the menu

You can access the menu mode by pressing **Menu/Set**.
 When you enter the menu, the LCD scrolls.

Press **1** for General Setup menu

—OR—

Press **2** for Fax menu

—OR—

Press **3** for Copy menu

⋮

Press **0** for Initial Setup

Select ▲▼ & Set
 1.General Setup

Select ▲▼ & Set
 2.Fax

Select ▲▼ & Set
 3.Copy

Select ▲▼ & Set
 0.Initial Setup

You can scroll more quickly through each menu level by pressing the arrow for the direction you want: ▲ or ▼. Select an option by pressing **Menu/Set** when that option appears on the LCD.

The LCD will then show the next menu level.

Press ▲ or ▼ to scroll to your next menu selection.

Press **Menu/Set**.

When you finish setting an option, the LCD shows *Accepted*.

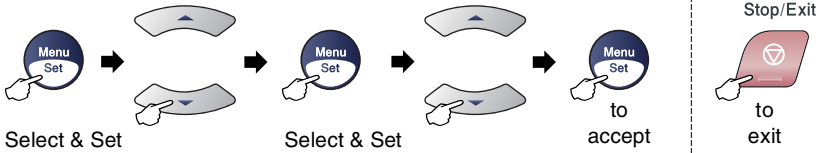

Main Menu	Submenu	Menu Selections	Options	Descriptions	Page
1.General Setup	1.Mode Timer	—	5 Mins 2 Mins 1 Min 30 Secs 0 Sec Off	Sets the time to return to Fax mode.	2-3
	2.Paper Type	—	Plain Inkjet Glossy Transparency	Sets the type of paper in the paper tray.	2-3
	3.Paper Size (MFC-5440CN only)	—	Letter Legal A4 A5 4"x6"	Sets the size of the paper in the paper tray.	2-4
	3.Paper Size (MFC-5840CN only)	1.Tray#1	Letter Legal A4 A5 4"x 6"	Sets the size of paper in Tray#1.	2-3
		2.Tray#2	Letter Legal A4	Sets the size of paper in Tray#2.	2-3
	4.Volume	1.Ring	High Med Low Off	Adjusts the ring volume.	2-5
		2.Beeper	High Med Low Off	Adjusts the volume level of the beeper.	2-5
		3.Speaker	High Med Low Off	Adjusts the speaker volume.	2-6



The factory settings are shown in Bold.

Main Menu	Submenu	Menu Selections	Options	Descriptions	Page
1.General Setup (Continued)	5.Auto Daylight	—	On Off	Changes for Daylight Savings Time automatically.	2-6
	6.On/Off Setting	—	Fax Receive:On Fax Receive:Off	Customizes the On/Off key to receive faxes even in OFF mode.	2-7
	7.LCD Contrast	—	Light Dark	Adjust the contrast of the LCD.	2-7
	8.Tray Use: Copy (MFC-5840CN only)	—	Tray#1 Only Tray#2 Only Auto Select	Select the tray that will be used for Copy mode.	2-7
	9.Tray Use: Fax (MFC-5840CN only)	—	Tray#1 Only Tray#2 Only Auto Select	Select the tray that will be used for Fax mode.	2-8
2.Fax	1.Setup Receive (In Fax mode only)	1.Ring Delay	04 03 02 01 00	Sets the number of rings before the MFC answers in Fax Only or Fax/Tel mode.	4-2
		2.F/T Ring Time	70 Sec 40 Sec 30 Sec 20 Sec	Sets the pseudo/double-ring time in Fax/Tel mode.	4-3
		3.Easy Receive	On Off	Receives fax messages without pressing the Black Start or Color Start key.	4-4
	1.Setup Receive (In Fax mode only) (Continued)	4.Remote Code	On (* 51, #51) Off	You can answer all calls at an extension or external phone and use codes to turn the MFC on or off. You can personalize these codes.	A-8
		5.Auto Reduction	On Off	Reduces the size of incoming faxes.	4-5
		6.Polling RX	—	Sets up your MFC to poll another fax machine.	4-6



The factory settings are shown in Bold.

Main Menu	Submenu	Menu Selections	Options	Descriptions	Page
2.Fax (Continued)	2.Setup Send (In Fax mode only)	1.Contrast	Auto Light Dark	Changes the lightness or darkness of faxes you send.	3-7
		2.Fax Resolution	Standard Fine S.Fine Photo	Sets the default resolution for outgoing faxes.	3-8
		3.Delayed Fax	—	Set the time of day in 24 hour format that the delayed faxes will be sent.	3-14
		4.Batch TX	On Off	Combines delayed faxes to the same fax number at the same time of day into one transmission.	3-15
		5.Real Time TX	Off On Next Fax Only	You can send a fax without using the memory.	3-10
		6.Polled TX	On Off	Sets up your MFC with an document to be retrieved by another fax machine.	3-14
		7.Overseas Mode	On Off	If you are having difficulty sending faxes overseas, set this to On .	3-13
		0.Glass Fax Size	Letter A4	Adjust the scan area of the scanner glass to the size of the document.	3-15
	3.Set Quick-Dial	1.Speed-Dial	—	Stores Speed-Dial numbers, so you can dial by pressing only a few keys (and Start).	5-1
		2.Setup Groups	—	Sets up a Group number for Broadcasting.	5-3



The factory settings are shown in Bold.

Main Menu	Submenu	Menu Selections	Options	Descriptions	Page	
2.Fax (Continued)	4.Report Setting	1.Transmission	On On+Image Off Off+Image	Initial setup for Transmission Verification Report and Fax Journal Report.	7-1	
		2.Journal Period	Every 7 Days Every 2 Days Every 24 Hours Every 12 Hours Every 6 Hours Every 50 Faxes Off		7-2	
	5.Remote Fax Opt	1.Fwd/Page/ Store	Off Fax Forward Paging Fax Storage PC Fax Receive	Sets the MFC to forward fax messages, to call your pager, to store incoming faxes in the memory (so you can retrieve them while you are away from your MFC), or to send faxes to your PC.	6-1 6-2	
		2.Remote Access	---*		You must set your own code for Remote Retrieval.	6-4
		3.Print Fax (Backup Print)	—		Prints incoming faxes stored in the memory.	4-5 6-3
	6.Remaining Jobs	—	—	Checks which jobs are in the memory and lets you cancel selected jobs.	3-11	
	0.Miscellaneous	1.Compatibility	High Normal Basic	Adjust the equilization for transmission problems.	11-14	
		2.Distinctive	Off Set (On)	Uses the Telephone Company's Distinctive Ring subscriber service to register the ring pattern with the MFC.	A-1	
		3.Caller ID	Display# Print Report	View or print a list of the last 30 Caller IDs stored in the memory.	A-5	



The factory settings are shown in Bold.

Main Menu	Submenu	Menu Selections	Options	Descriptions	Page	
3.Copy	1.Quality		Best Normal Fast	Selects the Copy resolution for your type of document.	8-16	
	2.Brightness	—	- ○○○○■ + - ○○○○□ + - ○○○■□ + - ○■○○○ + - ■○○○○ +	Adjusts the brightness.	8-16	
	3.Contrast	—	- ○○○○■ + - ○○○○□ + - ○○○■□ + - ○■○○○ + - ■○○○○ +	Adjusts the contrast for copies.	8-16	
	4.Color Adjust	1.Red		R:- ○○○○■ + R:- ○○○○□ + R:- ○○○○□ + R:- ○■○○○ + R:- ■○○○○ +	Adjusts the amount of Red in copies.	8-17
		2.Green		G:- ○○○○■ + G:- ○○○○□ + G:- ○○○○□ + G:- ○■○○○ + G:- ■○○○○ +	Adjusts the amount of Green in copies.	
		3.Blue		B:- ○○○○■ + B:- ○○○○□ + B:- ○○○○□ + B:- ○■○○○ + B:- ■○○○○ +	Adjusts the amount of Blue in copies.	



The factory settings are shown in Bold.

Main Menu	Submenu	Menu Selections	Options	Descriptions	Page
4.PhotoCapture (MFC-5840CN only)	1.Print Quality	—	Normal Photo	Selects the print quality.	9-9
	2.Paper & Size	—	Letter Glossy 4"x 6" Glossy 5"x 7" Glossy A4 Glossy Letter Plain A4 Plain Letter Inkjet A4 Inkjet 4"x 6" Inkjet	Selects the paper and print size.	9-9
	3.Brightness	—	- o o o o ■ + - o o o ■ o + - o o o o o + - o ■ o o o + - ■ o o o o +	Adjusts the brightness.	9-10
	4.Contrast	—	- o o o o ■ + - o o o ■ o + - o o o o o + - o ■ o o o + - ■ o o o o +	Adjusts the contrast.	9-10
	5.True2Life	On Off	1.White Balance - o o o o ■ + - o o o ■ o + - o o o o o + - o ■ o o o + - ■ o o o o + 2.Sharpness - o o o o ■ + - o o o ■ o + - o o o o o + - o ■ o o o + - ■ o o o o + 3.Color Density - o o o o ■ + - o o o ■ o + - o o o o o + - o ■ o o o + - ■ o o o o +	Adjusts the hue of the white areas. Enhances the detail of the image. Adjusts the total amount of color in the image.	9-10



The factory settings are shown in Bold.

Main Menu	Submenu	Menu Selections	Options	Descriptions	Page
4.PhotoCapture (Continued)	6.Cropping	—	On Off	Crops the image around the margin to fit the paper size or print size. Turn this feature Off if you want to print whole images or prevent unwanted cropping.	9-12
	7.Borderless	—	On Off	Expands the printable area to fit the edges of the paper	9-12
	8.Scan to Card	1.Quality	B/W 200x100 dpi B/W 200 dpi Color 150 dpi Color 300 dpi Color 600 dpi	Selects the Scan resolution for your type of document.	2-25* ¹
		2.B/W File Type	TIFF PDF	Selects the default file format for black and white scanning.	2-25* ¹
		3.ColorFile Type	PDF JPEG	Selects the default file format for color scanning.	2-25* ¹
4.LAN (MFC-5440CN) 5.LAN (MFC-5840CN)	1.Setup TCP/IP	1.BOOT Method	Auto Static RARP BOOTP DHCP	You can choose the BOOT method that best suits you needs.	See Network User's Guide on the CD-ROM
		2.IP Address	[000-255]. [000-255]. [000-255]. [000-255]	Enter the IP address.	
		3.Subnet Mask	[000-255]. [000-255]. [000-255]. [000-255]	Enter the Subnet mask.	
		4.Gateway	[000-255]. [000-255]. [000-255]. [000-255]	Enter the Gateway address.	



The factory settings are shown in Bold.

*¹ See the complete Software User's Guide on the CD-ROM.

Main Menu	Submenu	Menu Selections	Options	Descriptions	Page
4.LAN (MFC-5440CN) 5.LAN (MFC-5840CN) (Continued)	1.Setup TCP / IP (Continued)	5.Host Name	BRN_XXXXXX	Enter the Host name.	See Network User's Guide on the CD-ROM
		6.WINS Config	Auto Static	You can choose the WINS configuration mode.	
		7.WINS Server	(Primary) 000.000.000.000	Specifies the IP address of the primary or secondary server.	
		8.DNS Server	(Primary) 000.000.000.000	Specifies the IP address of the primary or secondary server.	
		9.APIPA	On Off	Automatically allocates the IP address from the link-local address range.	
	2.Setup Misc.	1.Ethernet	Auto 100B-FD 100B-HD 10B-FD 10B-HD	Selects Ethernet link mode.	
		2.Time Zone	GMT-05:00	Sets the time zone for your country.	
	0.Factory Reset	—	—	Restore all network settings to factory default.	
	6.Print Reports (MFC-5840CN only)	1.Help List	—	—	
2.Quick-Dial		—	—		
3.Fax Journal		—	—		
4.Transmission		—	—		
5.User Settings		—	—		
6.Network Config		—	—		



The factory settings are shown in Bold.

Main Menu	Submenu	Menu Selections	Options	Descriptions	Page
0.Initial Setup	1.Receive Mode	—	Fax Only Fax/Tel External TAD Manual	You can choose the receive mode that best suits your needs.	4-1 4-2
	2.Date/Time	—	—	Puts the date and time on the LCD and in headings of faxes you send.	2-1
	3.Station ID	—	Fax: Name:	Program your name and fax number to appear on each page you fax.	2-2
	4.Tone/Pulse	—	Tone Pulse	Selects the dialing mode.	2-3
	0.Local Language (Canada only)	—	English French	Allows you to change the LCD Language for your country.	See Quick Setup Guide



The factory settings are shown in Bold.

Entering Text

When you are setting certain menu selections, such as the Station ID, you may need to type text into the MFC. Most number keys have three or four letters printed above them. The keys for **0**, **#** and ***** do not have printed letters because they are used for special characters.

By pressing the appropriate number key repeatedly, you can access the character you want.

Press Key	one time	two times	three times	four times
2	A	B	C	2
3	D	E	F	3
4	G	H	I	4
5	J	K	L	5
6	M	N	O	6
7	P	Q	R	S
8	T	U	V	8
9	W	X	Y	Z

Inserting spaces

To enter a space in the fax number, press ► once between numbers. To enter a space in the name, press ► twice between characters.

Making corrections

If you entered a letter incorrectly and want to change it, press ◀ to move the cursor under the incorrect character. Then press **Stop/Exit**. All letters above and to the right of the cursor will be deleted. Re-enter the correct character. You can also back up and type over incorrect letters.

Repeating letters

If you need to enter a character that is on the same key as the previous character, press ► to move the cursor to the right before you press the key again.

Special characters and symbols

Press *****, **#** or **0**, and then press **◀** or **▶** to move the cursor under the special character or symbol you want. Then press **Menu/Set** to select it.

Press *	for	(space) ! " # \$ % & ' () * + , - . / €
Press #	for	: ; < = > ? @ [] ^ _
Press 0	for	É À È Ê Î Ç Ë Ö 0

G Glossary

ADF (automatic document feeder) The document can be placed in the ADF and scanned one page at a time automatically.

Auto Reduction Reduces the size of incoming faxes.

Automatic fax transmission Sending a fax without pressing **Hook** or picking up the handset of an external phone.

Automatic Redial A feature that enables your MFC to redial the last fax number after five minutes if the fax did not go through because the line was busy.

Backup Print Your MFC prints a copy of every fax that is received and stored in memory.

This is a safety feature so you will not lose messages during a power failure.

Batch Transmission (Black and white faxes only) As a cost saving feature, all delayed faxes to the same fax number will be sent as one transmission.

Beeper Volume Volume setting for the beep when you press a key or make an error.

Brightness Changing the Brightness makes the whole image lighter or darker.

Broadcasting The ability to send the same fax message to more than one location.

Caller ID A service purchased from the telephone company that lets you see the number (or name) of the party calling you.

Cancel Job Cancels a programmed job, like Delayed Fax or Polling.

CNG tones The special tones (beeps) sent by fax machines during automatic transmission to tell the receiving machine that a fax machine is calling.

Coding method Method of coding the information contained in the document. All fax machines must use a minimum standard of Modified Huffman (MH). Your MFC is capable of greater compression methods, Modified Read (MR), Modified Modified Read (MMR) and JPEG, if the receiving machine has the same capability.

Communication error (or Comm. Error) An error during fax sending or receiving, usually caused by line noise or static.

Compatibility group The ability of one fax unit to communicate with another. Compatibility is assured between ITU-T Groups.

Contrast Setting to compensate for dark or light documents, by making faxes or copies of dark documents lighter and light documents darker.

Delayed Fax Sends your fax at a specified later time that day.

Distinctive Ring A subscriber service purchased from the telephone company that gives you another phone number on an existing phone line. The Brother MFC uses the new number to simulate a dedicated fax line.

Dual Access Your MFC can scan outgoing faxes or scheduled jobs into memory at the same time it is sending a fax or receiving or printing an incoming fax.

Easy Receive Enables your MFC to respond to CNG tones if you interrupt a fax call by answering it.

ECM (Error Correction Mode) Detects errors during fax transmission and resends the pages of the fax that had an error.

Extension phone A telephone on the fax number that is plugged into a separate wall jack.

External phone A telephone that is plugged into the EXT jack of your MFC.

F/T Ring Time The length of time that the Brother MFC rings (when the Receive Mode setting is Fax/Tel) to notify you to pick up a voice call that it answered.

Fax Forwarding Sends a fax received into the memory to another pre-programmed fax number.

- Fax Journal** Lists information about the last 200 incoming and outgoing faxes. TX means Transmit. RX means Receive.
- Fax Receive Code** Press this code (* 5 1) when you answer a fax call on an extension or external phone.
- Fax Storage** You can store faxes in memory.
- Fax tones** The signals sent by sending and receiving fax machines while communicating information.
- Fax/Tel** You can receive faxes and telephone calls. Do not use this mode if you are using a telephone answering device (TAD).
- Fine resolution** Resolution is 203 × 196 dpi. It is used for small print and graphs.
- Gray scale** The shades of gray available for copying and faxing photographs.
- Group number** A combination of Speed-Dial numbers that are stored in a Speed-Dial location for Broadcasting.
- Help list** A printout of the complete Menu table that you can use to program your MFC when you do not have the User's Guide with you.
- Journal Period** The pre-programmed time period between automatically printed Fax Journal Reports. You can print the Fax Journal on demand without interrupting the cycle.
- LCD (liquid crystal display)** The display screen on the MFC that shows interactive messages during On-Screen Programming and shows the date and time when the MFC is idle.
- Manual fax** When you lift the handset of your external telephone or press **Hook** so you can hear the receiving fax machine answer before you press **Black Start** or **Color Start** to begin transmission.
- Menu mode** Programming mode for changing your MFC's settings.
- OCR (optical character recognition)** The bundled ScanSoft® OmniPage® software application converts an image of text to text you can edit.
- Out of Paper Reception** Receives faxes into the MFC's memory when the MFC is out of paper.

- Overseas Mode** Makes temporary changes to the fax tones to accommodate noise and static on overseas phone lines.
- Paging** This feature enables your MFC to call your pager when a fax is received into its memory.
- Pause** Allows you to place a 3.5 second delay in the dialing sequence stored on Speed-Dial numbers. Press **Redial/Pause** as many times as needed for longer pauses.
- PhotoCapture Center™** (MFC-5840CN only) Allows you to print digital photos from your digital camera at high resolution for photo quality printing.
- Photo resolution** A resolution setting that uses varying shades of gray for the best representation of photographs.
- Polling** The process of a fax machine calling another fax machine to retrieve waiting fax messages.
- Pulse** A form of rotary dialing on a telephone line.
- Quick Dial List** A listing of names and numbers stored in Speed-Dial memory, in numerical order.
- Real Time Transmission** When memory is full, you can send faxes in real time.
- Remaining jobs** You can check which jobs are waiting in memory and cancel jobs individually.
- Remote Access Code** Your own four-digit code (---*) that allows you to call and access your MFC from a remote location.
- Remote Retrieval Access** The ability to access your MFC remotely from a touch tone phone.
- Resolution** The number of vertical and horizontal lines per inch. See: Standard, Fine, Super Fine and Photo.
- Ring Delay** The number of rings before the MFC answers in Fax Only and Fax/Tel mode.
- Ring Volume** Volume setting for the MFC's ring.
- Scanning** The process of sending an electronic image of a paper document into your computer.

Scan to Card (MFC-5840CN only) You can scan a black and white or color document into a Media Card. Black and white images will be in TIFF or PDF file format and color images may be in PDF or JPEG file format.

Search An electronic, alphabetical listing of stored Speed-Dial and Group numbers.

Speed-Dial A pre-programmed number for easy dialing. You must press the **Search/Speed Dial** key, #, and the two digit code and **Black Start** or **Color Start** to start the dialing process.

Standard resolution 203 x 97 dpi. It is used for regular size text and quickest transmission.

Station ID The stored information that appears on the top of faxed pages. It includes the sender's name and fax number.

Super Fine resolution 392 x 203 dpi. Best for very small print and line art.

TAD (telephone answering device) You can connect an external device or answering machine to the EXT. of your MFC.

Telephone Answer Code (Fax/Tel mode only) When the MFC answers a voice call, it pseudo/double-rings. You can pick up at an extension phone by pressing this code (**# 5 1**).

Temporary settings You can select certain options for each fax transmission and copy without changing the default settings.

Tone A form of dialing on the telephone line used for Touch Tone telephones.

Transmission The process of sending faxes over the phone lines from your MFC to the receiving fax machine.

Transmission Verification Report A listing of each transmission, that shows its date, time and number.

True2Life® Adjusts the color in the image for better print quality by improving sharpness, white balance and color density.

User Settings A printed report that shows the current settings of the MFC.

S Specifications

Product description

General

Memory Capacity	16 MB
Automatic Document Feeder (ADF)	Up to 35 pages Temperature: 68°F - 86°F (20°C - 30°C) Humidity: 50% - 70% Paper: 20 lb Letter size
Paper Tray	100 Sheets (20 lb)
Paper Tray#2 (MFC-5840CN only)	250 Sheets (20 lb)
Printer Type	Ink Jet
Print Method	Piezo with 74 × 5 nozzles
LCD (Liquid Crystal Display)	16 characters × 2 lines
Power Source	100 - 120V AC 50/60Hz
Power Consumption	(MFC-5440CN) Off Mode: Under 5 watts Standby: 9 Wh or less (25°C) Operating: 22 Wh or less (MFC-5840CN) Off Mode: Under 5 watts Standby: 9 Wh or less (25°C) Operating: 24 Wh or less

Dimensions

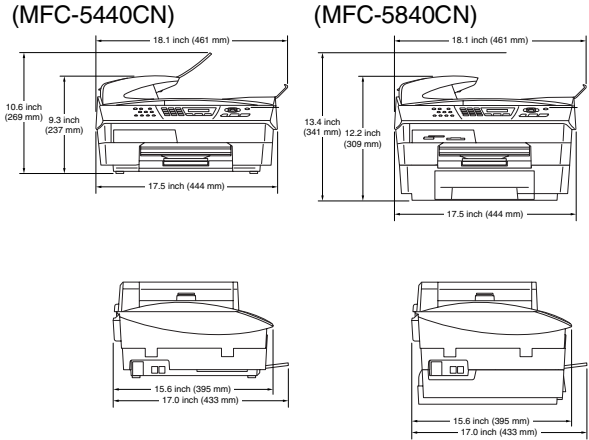

Weight

17.6 lb (8.0 kg) (MFC-5440CN)

21.8 lb (9.9 kg) (MFC-5840CN)

Noise

Operating: 42.5 to 51 dB*

* It depends on printing conditions.

Temperature

Operating: 50°F - 95°F (10°C - 35°C)

Best Print

Quality: 68°F - 91°F (20°C - 33°C)

Humidity

Operating: 20 to 80% (without condensation)

Best Print

Quality: 20 to 80% (without condensation)

Print media

Paper Input

Paper Tray

- Paper type:
Plain paper, inkjet paper (coated paper), glossy paper*², transparencies*^{1*2} and envelopes
- Paper size:
Letter, Legal*³, Executive, A4, A5, A6, JIS_B5, envelopes (commercial No.10, DL, C5, Monarch, JE4), Photo card, Index card and Post card.
For more details, see *Paper weight, thickness and capacity* on page 1-13.
- Maximum paper tray capacity:
Approx. 100 sheets of 20 lb plain paper

Paper Tray#2 (MFC-5840CN only)

- Paper type:
Plain paper
- Paper size:
Letter, Legal*³, Executive, A4, JIS_B5
- Maximum paper tray capacity:
Approx. 250 sheets of 20 lb plain paper

Paper Output

Up to 50 sheets of Letter plain paper (Face up print delivery to the output paper tray)*²

*¹ Use only transparencies recommended for inkjet printing.

*² For glossy paper or transparencies, we recommend removing printed pages from the output paper tray immediately after they exit the machine to avoid smudging.

*³ Legal paper cannot be stacked on the output paper tray.

Copy

Color/Black

Color/Black

Document Size

ADF Width: 5.8" to 8.5"

ADF Height: 5.8" to 14"

Scanner Glass Width: 8.5 in.

Scanner Glass Height: 11.7 in.

Copy Speed

Black

Up to 17 pages/minute (Letter paper)*

Color

Up to 11 pages/minute (Letter paper)*

* Does not include the time it takes to feed the paper.

Based on Brother standard pattern. (Fast mode/Stack Copy)

Copy speeds vary with the complexity of the document.

Multiple Copies

Stacks/Sorts up to 99 pages

Enlarge/Reduce

25% to 400% (in increments of 1%)

Resolution

Up to 600 x 1200 dpi copy resolution for plain,
1200 x 1200 dpi for inkjet, glossy paper and
OHP/transparency.

PhotoCapture Center (MFC-5840CN only)

Available Media	CompactFlash® (Type I only) (Microdrive™ is not compatible) (Compact I/O card such as Compact LAN card and Compact Modem card are not supported.) SmartMedia® (3.3V) (Not available for use with ID) Memory Stick® (Not available for music data with MagicGate™) SecureDigital™ xD-Picture Card™
File Extension (Media Format) (Image Format)	DPOF, EXIF, DCF Photo Print: JPEG* Scan to Card: JPEG, PDF (Color) TIFF, PDF (Black)
Color Enhancement	* Progressive JPEG format is not supported. True2Life
Number of Files	Up to 999 files in the media card
Folder	File must be in the 3rd folder level of the Media Card.
Borderless	Letter, A4, Photo Card

Fax

Compatibility	ITU-T Group 3
Coding System	MH/MR/MMR/JPEG
Modem Speed	Automatic Fallback 33600 bps
Document Size	ADF Width: 5.8" to 8.5" ADF Height: 5.8" to 14" Scanner Glass Width: 8.5 in. Scanner Glass Height: 11.7 in.
Scanning Width	8.2 in.
Printing Width	8.03 in.
Gray Scale	256 levels
Polling Types	Standard, Sequential: (Black only)
Contrast Control	Automatic/Light/Dark (manual setting)
Resolution	<ul style="list-style-type: none">• Horizontal 203 dot/inch (8 dot/mm)• Vertical Standard -<ul style="list-style-type: none">98 line/inch (Black)196 line/inch (Color)Fine - 196 line/inch (Black/Color)Photo - 196 line/inch (Black)Superfine - 392 line/inch (Black)
Speed-Dial	40 stations (MFC-5440CN) 100 stations (MFC-5840CN)
Broadcasting	90 stations (MFC-5440CN) 150 stations (MFC-5840CN)
Automatic Redial	1 time after 5 minutes
Auto Answer	0, 1, 2, 3 or 4 rings
Communication Source	Public switched telephone network.

Memory Transmission Up to 200*¹/170*² pages (MFC-5440CN)
Up to 480*¹/400*² pages (MFC-5840CN)

Out of Paper Reception Up to 200*¹/170*² pages (MFC-5440CN)
Up to 480*¹/400*² pages (MFC-5840CN)

*¹ "Pages" refers to the "Brother Standard Chart No. 1" (a typical business letter, Standard resolution, MMR code). Specifications and printed materials are subject to change without prior notice.

*² "Pages" refers to the "ITU-T Test Chart #1" (a typical business letter, Standard resolution, MMR code). Specifications and printed materials are subject to change without prior notice.

Scanner

Color/Black	Color/Black
TWAIN Compliant	Yes (Windows® 98/98SE/Me/2000 Professional/XP) Mac OS® 8.6-9.2/Mac OS® X 10.2.4 or greater
WIA Compliant	Yes (Windows® XP)
Color Depth	48 bit color Processing (Input) 48 bit color Processing (Output)
Resolution	Up to 19200 × 19200 dpi (interpolated)* Up to 1200 × 2400 dpi (optical) * Maximum 1200 x 1200 dpi scanning with Windows® XP (resolution up to 19200 x 19200 dpi can be selected by using the Brother scanner utility)
Scanning Speed	Color: up to 4.48 sec. Black: up to 3.30 sec. Letter size in 100 × 100 dpi)
Document Size	ADF Width: 5.8" to 8.5" ADF Height: 5.8" to 14" Scanner Glass Width: Max. 8.5" Scanner Glass Height: Max. 11.7"
Scanning Width	8.26 in.
Gray Scale	256 levels

 Mac OS® X scanning is supported in Mac OS® X 10.2.4 or greater.

Printer

Printer Driver	Windows® 98/98SE/Me/2000 Professional and XP driver supporting Brother Native Compression mode and bi-directional capability Apple® Macintosh® QuickDraw® Driver For Mac OS® 8.6-9.2/Mac OS® X 10.2.4 or greater
Resolution	Up to 1200 x 6000 dots per inch (dpi)* 1200 x 1200 dots per inch (dpi) 600 x 600 dots per inch (dpi) 600 x 150 dots per inch (dpi) <small>* Output image quality varies based upon many factors including but not limited to input image resolution and quality and print media.</small>
Print Speed	up to 20 pages/minute (Black)* up to 15 pages/minute (Color)* <small>* Based on Brother standard pattern. Letter size in draft mode. Does not include the time it takes to feed the paper.</small>
Printing Width	8.03 inches (8.5 inches)* <small>* When you set the Borderless feature to On.</small>
Disk-Based Fonts	35 TrueType
Borderless	Letter, A4, A6, Photo Card, Index Card, Post Card (Not available for Tray#2 (MFC-5840CN only))

Interfaces

USB	A Full-Speed USB 2.0 cable that is no longer than 6 feet (2.0 m)* <small>* Your MFC has a Full-Speed USB 2.0 interface. This interface is compatible with Hi-Speed USB 2.0; however, the maximum data transfer rate will be 12 Mbits/s. The MFC can also be connected to a computer that has a USB 1.1 interface.</small>
LAN cable	Ethernet UTP cable category 5 or greater.

Computer requirements

Minimum System Requirements					
Computer Platform & Operating System Version		Processor Minimum Speed	Minimum RAM	Recommended RAM	Available Hard Disk Space
					for Drivers
Windows® *1 Operating System	98, 98SE	Pentium II or equivalent	32 MB	64 MB	90 MB
	Me				
	2000 Professional		64 MB	128 MB	
	XP*2	128 MB	256 MB	150 MB	
Apple® Macintosh® Operating System	Mac OS® 8.6 (Printing and PC-FAX Send*4 Only)	All base models meet minimum Requirements		64 MB	80 MB
	Mac OS® 9.X (Printing, Scanning*3, PhotoCapture Center™ and PC-FAX Send*4 Only)				
	Mac OS® X 10.2.4 or greater		128 MB	160 MB	

NOTE: All registered trademarks referenced herein are the property of their respective companies.

*1 Microsoft® Internet Explorer 5 or greater.

*2 Maximum 1200 x 1200 dpi scanning with Windows® XP. (Resolutions up to 19200 x 19200 dpi can be selected using the Brother Utility.)

*3 Dedicated "Scan" key and direct Network Scanning supported in Mac® Operating Systems Mac OS® X 10.2.4 or greater.

*4 PC Fax supports black and white faxing only.

Consumable items

Ink

The MFC uses individual Black, Yellow, Cyan and Magenta ink cartridges that are separate from the print head assembly.

Service Life of Ink Cartridge

Standard Black - Approximately 500 pages at 5% coverage

High Yield Black - Approximately 900 pages at 5% coverage

Yellow, Cyan and Magenta - Approximately 400 pages at 5% coverage

The above figures are based upon the following assumptions:

- Continuous printing at a resolution of 600 x 600 dpi in normal mode after installing new ink cartridge;
- The printing frequency;
- The number of pages printed;
- Periodic, automatic, print head assembly cleaning (Your MFC will clean the print head assembly periodically. This process will use a small amount of ink); and,
- Ink remaining in cartridge identified as “empty” (It is necessary to leave a small amount of ink in the ink cartridge to prevent air from drying out and damaging the print head assembly).

Network (LAN)

LAN	You can connect your MFC to a network for Network Printing, Network Scanning and PC Fax Send. Also included is Brother BRAdmin Professional Network Management software.
Support for	Windows® 98/98SE/Me/2000/XP Mac OS® 8.6 - 9.2, Mac OS® X 10.2.4 or greater* Ethernet 10/100 BASE-TX Auto Negotiation
Protocols	TCP/IP RARP, BOOTP, DHCP, APIPA, NetBIOS, WINS LPR/LPD, Port9100, SSDP, mDNS, FTP * Network Printing and PC-FAX are available for Mac OS® 8.6-9.2, Mac OS® 10.2.4 or greater. * Mac OS® 8.6-9.2 (Quick Draw over TCP/IP) * Mac OS® X 10.2.4 or greater (mDNS) * Network Scanning and Remote Setup are available for Mac OS® 10.2.4 or greater. * Media drive is not available for Mac OS® 8.6. Included Utilities: BRAdmin Professional (Windows®)  BRAdmin Professional is not supported in Mac OS®.

Optional External Wireless Print/Scan Server (NC-2200w)

NC-2200w External Wireless Print/Scan Server (Optional)	Connecting the optional External Wireless Print/Scan Server (NC-2200w) to your MFC will allow you to print and scan over a wireless network.
Network types	IEEE 802.11b wireless LAN
Support for	Windows® 98/98SE/Me/2000/XP Mac OS® X 10.2.4 or greater
Protocols	TCP/IP ARP, RARP, BOOTP, DHCP, APIPA (Auto IP), WINS/NetBIOS, DNS, LPR/LPD, Port9100, SMB Print, IPP, RawPort, mDNS, TELNET, SNMP, HTTP  You can assign the scan key to one networked computer only.

Index

A

- Access codes, storing and dialing 5-5
- Accessories and supplies ii
- ADF (automatic document feeder) 1-7, 3-3
- Answering machine (TAD) ... A-10
 - connecting A-12
- Automatic
 - fax receive 4-1
 - Easy Receive 4-4
 - fax redial 3-2
 - transmission 3-5

B

- Broadcasting 3-12
 - setting up Groups for 5-3
- Brother
 - accessories and supplies ii
 - Brother numbers i
 - Customer Service i
 - fax back system ii
 - Frequently asked questions (FAQs) i
 - product support i
 - Warranties iii, iv, vi

C

- Caller ID A-5
 - print list A-6
 - view list A-6
- Canceling
 - Fax Forwarding 6-6
 - fax jobs in memory 3-11
 - jobs awaiting redial 3-11
 - Paging 6-6

- Cleaning
 - print head 11-15
 - printer platen 11-24
 - scanner 11-23
- CNG tones 1-23
- Connecting
 - external TAD A-10
 - external telephone A-9
 - two-line external TAD or telephone A-15
- Consumable items S-10
- Control Center
 - See Software User's Guide on the CD-ROM.....
- Control panel overview 1-2
- Copy
 - brightness 8-10
 - color adjustment 8-17
 - contrast 8-16
 - default settings 8-16
 - Enlarge/Reduce 8-5, 8-8
 - enter Copy mode 8-1
 - keys 8-3
 - multiple 8-2
 - Out of Memory 8-17
 - Page Layout 8-12
 - paper 8-6, 8-9
 - Quality key 8-4, 8-8
 - quality setting 8-16
 - setting tray use 2-7
 - single 8-2
 - Sort (ADF only) 8-11
 - temporary settings 8-3
 - using ADF 8-2
- Cordless phone A-8
- Credit card numbers 5-5
- Custom telephone features
 - on a single line 11-12, A-16

D

Date and Time	2-1
Delayed Batch Transmission	3-15
Dialing a pause	5-5
access codes and credit card numbers	5-5
automatic fax redial	3-2
automatic transmission	3-5
Groups	3-12
manual transmission	3-1
Speed-Dial	3-2
Distinctive Ring	A-1
setting ring pattern	A-4
turning off	A-4
Dual Access	3-9

E

Easy Receive	4-4
ECM (Error Correction Mode)	1-24
Envelopes	1-14
Equalization	11-14
Error messages on LCD ...	11-1
Comm. Error	11-1
Ink Empty	11-2
Near Empty	11-2
No Paper Fed	11-2
Not Registered	3-2
Out of Memory	11-3
while scanning a document	8-17
Unable to Change	11-4
Unable to Clean	11-4
Unable to Init.	11-4
Unable to Print	11-4
Unable to Scan	11-4
Extension telephone, using	A-7

External telephone, connecting	A-9
---	-----

F

Fax codes changing	6-4, A-8
Fax Receive Code	A-7
Remote Access Code	6-4
Telephone Answer Code ...	A-7
Fax Forwarding changing remotely	6-6, 6-7
programming a number	6-1
Fax Storage	6-3
printing from memory	4-5
turning on	6-3
Fax, stand-alone receiving	4-1
compatibility	11-14
difficulties	11-10
Fax Forwarding	6-6
from extension phone	A-7
Paging	6-2
Polling Receive	4-6
reducing to fit on paper ...	4-5
retrieving from a remote site	6-7
Ring Delay, setting	4-2
Sequential Polling	4-6
setting tray use	2-8
sending	3-1
automatic	3-5
Broadcasting	3-12
canceling from memory	3-11
color fax	3-3
compatibility	11-14
contrast	3-7
enter Fax mode	3-1
from memory (Dual Access)	3-2, 3-9

- from PC
 - See Software User's Guide on the CD-ROM.....
 - from scanner glass3-4
 - manual3-5
 - overseas3-13
 - Polling Transmit3-14
 - Real Time Transmission3-10
 - resolution3-8
- Fax/Tel mode
 - answering at extension phonesA-7
 - double-ringing (voice calls)4-3
 - F/T Ring Time4-3
 - Fax Receive CodeA-7
 - receiving faxesA-7
 - Ring Delay4-2
 - Telephone Answer Code ...A-7
 - telephone callsA-7
- FCC notices10-1

G

- Gray scaleS-6, S-7
- Groups for Broadcasting5-3

H

- HELP
 - Help list7-3
 - LCD messagesB-1
 - using navigation keysB-2
 - Menu TableB-1, B-3

I

- Ink cartridges
 - checking ink volume11-19
 - replacing11-25
- Ink Dot Counter11-25

J

- Jacks
 - convert to RJ11 jack triplex adapterA-13
- EXT
 - external telephoneA-10
 - TAD (answering machine)A-10
- Jams
 - document11-5
 - paper11-5

L

- LCD (liquid crystal display)B-1, B-2
 - contrast2-7
 - Help List7-3

M

- Macintosh®
 - See Software User's Guide on the CD-ROM.....
- Maintenance, routine11-23
- Manual
 - dialing3-1
 - receive4-1
 - transmission3-5
- Memory StorageB-1
- Menu Selection TableB-1
- Mode Timer2-3
- Mode, entering
 - Copy8-1
 - Fax3-1
 - Scan1-3
- Multi-line connections (PBX)A-16

N

- Networking
 - printing
 - See Software User's Guide on the CD-ROM.
 - scanning
 - See Software User's Guide on the CD-ROM.

O

- Options key (copying)
 - Brightness 8-10
 - Paper Size 8-9
 - Paper Type 8-6, 8-9
- Out of Area (Caller ID) A-5

P

- Paging 6-2
 - programming your pager
 - number 6-2
- Paper 1-10, S-3
 - size 2-4
 - Type 2-3
- PaperPort®
 - See Software User's Guide on the CD-ROM.
- PC Fax Receive 6-3
- PC Faxing
 - See Software User's Guide on the CD-ROM.
- Phone line
 - connections A-12
 - difficulties 11-11
 - multi-line (PBX) A-16
 - roll over lines A-13
 - two-line phone system ... A-13
- PhotoCapture Center™
 - Borderless 9-12
 - CompactFlash® 9-1

- Cropping 9-12
- Default Settings 9-9
- DPOF printing 9-8
 - from PC
 - See Software User's Guide on the CD-ROM.
- Memory Stick® 9-1
- Printing images 9-6
- Printing Index 9-5
- SecureDigital™ 9-1
- SmartMedia® 9-1
- specifications S-5
- xD-Picture Card™ 9-1
- Polling 4-6
- Power failure B-1
- Print
 - area 1-14
 - difficulties 11-9, 11-10
 - drivers S-8
 - fax from memory 4-5
 - from PC
 - See Software User's Guide on the CD-ROM.
 - improving quality 11-15
 - paper jams 11-6
 - report 7-3
 - resolution S-8
 - specifications S-8
- Programming your MFC B-1, B-2

Q

- Quality key (copying) 8-3
- Quick-Dial
 - Access codes and credit card numbers
 - setting up 5-5
- Broadcasting 3-12
 - using Groups 3-12

Group dial		Resolution	
changing	5-2	copy	S-4
setting up Groups for		fax (Standard, Fine,	
Broadcasting	5-3	SuperFine, Photo)	S-6
Search	3-2	print	S-8
Speed-Dial		scan	S-7
changing	5-2	setting for next fax	3-8
setting up	5-1	Ring Delay, setting	4-2
using	3-2		
		S	
		Safety Instructions	vii, 10-6
		Scan size, setting	3-15
		Scanning	
		See Software User's Guide on	
		the CD-ROM.....	
		Setting tray use	2-7
		Setup	
		Date and Time	2-1
		Station ID (fax header)	
		entering text	2-2
		Shipping the machine	11-20
		Speed-Dial	
		changing	5-2
		dialing	3-2
		storing	5-1
		T	
		TAD (telephone answering device),	
		external	4-1, A-10, A-15
		connecting	A-10, A-12
		receive mode	4-1
		recording OGM	A-12
		with two-line jack	A-15
		Temporary copy settings	8-3
		Text, entering	B-12
		special characters	B-13
		tray use, setting	
		copy	2-7
		fax	2-8
R			
Receive Mode	4-2		
External TAD	4-1		
Fax Only	4-1		
Fax/Tel	4-1		
Manual	4-1		
Redial/Pause	3-2		
Reducing			
copies	8-5, 8-8		
incoming faxes	4-5		
Remote Retrieval	6-5		
access card	R-1		
access code	6-4, 6-5		
commands	6-6		
getting your faxes	6-7		
Remote Setup			
See Software User's Guide on			
the CD-ROM.....			
Reports	7-1		
Caller ID List	A-6		
Fax Journal	7-3		
Journal Period	7-2		
Help List	7-3		
how to print	7-3		
Network Configuration	7-3		
Quick-Dial List	7-3		
Transmission			
Verification	7-1, 7-3		
User Settings	7-3		

Troubleshooting	11-1
checking ink volume	11-19
document jam	11-5
error messages on LCD ...	11-1
if you are having difficulty	
copying	11-12
incoming calls	11-12
Network	11-13
phone line	11-14
phone line difficulties ...	11-11
PhotoCapture Center™	
.....	11-13
printing	11-9
printing or receiving	
faxes	11-10
Printing Received	
Faxes	11-10
receiving faxes	11-11
scanning	11-12
sending faxes	11-11
software	11-12
paper jam	11-6
print quality	11-15
True2Life®	
PhotoCapture Center™ ...	9-10
Two-line phone system	A-13

V

Volume, setting	2-5
beeper	2-5
ring	2-5
speaker	2-6

W

Warranties	iii
Canada	vi
Notice-Disclaimer	iii
USA	iv
World Wide Web	i

Remote Retrieval Access card

If you plan to receive fax messages while away from your MFC, carrying the Remote Retrieval Access Card printed below will serve as a convenient reminder of the retrieval procedures. Simply cut out the card and fold it to fit your wallet or organizer. Keeping it handy will help you derive the full benefit of your MFC's Paging, Fax Forwarding, and Remote Retrieval features.

REMOTE RETRIEVAL ACCESS CARD

Using Remote Access Code

- 1 Dial your fax number from a telephone or fax machine using touch tone.
- 2 When your machine answers, immediately enter your Remote Access Code (3 digits followed by *).
- 3 Your machine signals the kinds of messages it received:
1 long beep — Fax messages
No beeps — No messages.
- 4 After 2 short beeps, enter a command.
- 5 Press **90** to reset your machine when you finish.
- 6 Hang up.

CHECK RECEIVING STATUS
Press **971**
1 long beep — Fax messages
3 short beeps — No messages

CHANGE RECEIVE MODE
Press **98**
then for External TAD, press **1**.
Fax/Tel, press **2**.
Fax Only, press **3**.

EXIT REMOTE OPERATION
Press **90**.

Fold ← ← Fold

1 4

Changing Remote Access Code

- 1 Press **Menu/Set**, 2, 5, 2.
- 2 Enter a three-digit number from 000 to 999.
The * cannot be changed.
- 3 Press **Menu/Set**.
- 4 Press **Stop/Exit**.

Remote Commands

CHANGE PAGING/FAX FORWARDING SETTING

- Press **9 5**.
- Then to*
- Turn feature Off, press **1**.
 - Select Fax Forwarding, press **2**.
 - Select Paging, press **3**.

Fold →

Program Fax Forwarding Number, press **4**. Enter the new fax number where you want your fax messages forwarded followed by **##**.

Turn Fax Storage On, press **6**.

RETRIEVE A FAX

- Press **9 6**.
- Then to*
- Retrieve all faxes, press **2**.
 - then enter the number of remote fax machine followed by **##**.
 - After the beep, hang up and wait.
 - Erase all fax messages, press **3**.

← Fold

EQUIPMENT ATTACHMENT LIMITATIONS (Canada only)

NOTICE

This product meets the applicable Industry Canada technical specifications.

NOTICE

The Ringer Equivalence Number is an indication of the maximum number of devices allowed to be connected to a telephone interface. The termination on an interface may consist of any combination of devices subject only to the requirement that the sum of the RENs of all the devices does not exceed five.

brother®

Brother International Corporation
100 Somerset Corporate Boulevard
P.O. Box 6911
Bridgewater, NJ 08807-0911 USA

Brother International Corporation (Canada) Ltd.
1 rue Hôtel de Ville,
Dollard-des-Ormeaux, QC, CANADA H9B 3H6

**Visit us on the World Wide Web
<http://www.brother.com>**

These machines are made for use in the USA and Canada only. We cannot recommend using them overseas because it may violate the Telecommunications Regulations of that country and the power requirements of your multi-function center may not be compatible with the power available in foreign countries. **Using USA or Canada models overseas is at your own risk and may void your warranty.**



LF5886001①