

OWNER'S MANUAL

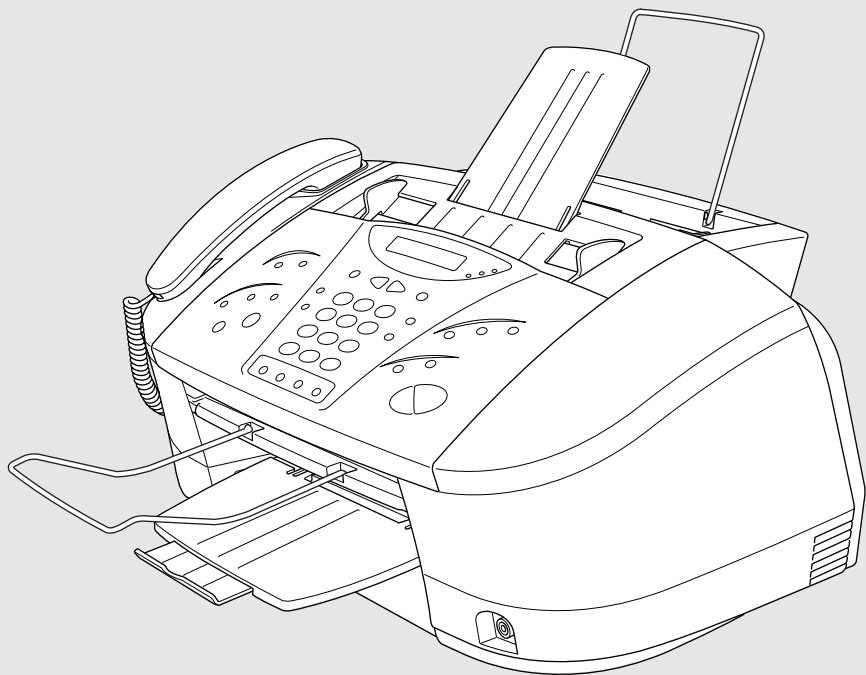

MFC 7300C

MFC 7400C

brother.

If You Need to Call Customer Service

Please complete the following information for future reference:

Model Number: MFC 7300C, MFC 7400C
(Circle your model number)

Serial Number: _____

Date of Purchase: _____

Place of Purchase: _____

*** The serial number is on the back of the unit. Retain this Owner's Manual with your sales receipt as a permanent record of your purchase, in the event of a theft, fire or warranty service.**

Year 2000 Compliant

Brother is addressing the Year 2000 related issues for all Brother fax machines and multi-function centers. Our focus is to ensure that our bundled third party software will continue to properly process date/time data after January 1, 2000.

Brother fax machines and multi-function centers will function properly after January 1, 2000, provided that all non-Brother hardware, software and firmware used by our customers in connection or combination with Brother fax machines, MFCs and bundled software, accurately exchange date data with the Brother products.

Please continue to check our Web page for updates at **<http://www.brother.com>**. All remedies will be provided to individual customers via software patches through software download or from Brother Customer Service.

Brother Numbers

Brother fax-back system

Brother Customer Service has installed an easy-to-use fax-back system, so you can get instant answers to common technical questions and product information for all Brother products. This system is available 24 hours a day, 7 days a week. You can use the system to send faxes to any fax machine, not just the one from which you are calling.

If you can't resolve difficulty with your MFC machine using this manual, call our fax-back system, and follow the voice prompts to receive faxed instructions about using the system, and an index of fax-back subjects.

USA: 1-800-521-2846

From within Canada: 1-800-681-9838

The Brother fax-back system number (USA only) has been preprogrammed on One Touch key **1**.

Frequently Asked Questions (FAQs)

You can find more information about Brother products on the World Wide Web. From product specification sheets to Frequently Asked Questions (FAQs), it is all there. Visit us at:

<http://www.brother.com>



You can check here for Brother Printer Driver updates.

Brother Bulletin Board

Brother's Bulletin Board Numbers are

USA: 1-888-298-3616

From within Canada: 1-514-685-2040

For Customer Service

USA: 1-800-284-4329 (voice)
1-908-575-8790 (fax)

From within Canada: 1-800-853-6660 (voice)
1-514-685-4898 (fax)

From within Montreal: 1-514-685-6464 (voice)

Ordering Accessories and Supplies

For best quality results use only genuine Brother accessories, available at most Brother retailers. If you cannot find the accessory you need and you have a Visa, MasterCard, Discover, or American Express credit card, you can order accessories directly from Brother. (In the USA, you can visit us online for a complete selection of Brother accessories and supplies available for purchase.)

USA: 1-888-879-3232 (voice)

1-800-947-1445 (fax)

<http://www.brothermall.com>

From within 1-800-668-2768 (voice)

Canada:

Description	Item
Ink Cartridge <black>	LC04BK
Ink Cartridge <cyan>(blue)	LC04C
Ink Cartridge <magenta>(red)	LC04M
Ink Cartridge <yellow>	LC04Y
720 dpi High Quality Coated Paper	BP72CL
Glossy Paper	BPGLL
Transparancies	BPTRL
Print Head	HD004
Power Protector	QPD120
Telephone Line Cord	UG3565001
Telephone Handset	LE0446011
Handset Curled Cord	UG3543011
Paper Wire Extension	UU1309001
Document Wire Extension	LE3305001
Document Support	UU2080001
Paper Tray	UU2069001
Owner's Manual	LE13310001 (English for USA and Canada) LE3487001 (French for Canada)



Brother Coated Paper is Ink Jet Paper.

Notice – Disclaimer of Warranties (For USA and Canada)

BROTHER'S LICENSOR(S), AND THEIR DIRECTORS, OFFICERS, EMPLOYEES OR AGENTS (COLLECTIVELY BROTHER'S LICENSOR) MAKE NO WARRANTIES, EXPRESS OR IMPLIED, INCLUDING WITHOUT LIMITATION THE IMPLIED WARRANTIES OF MERCHANTABILITY AND FITNESS FOR A PARTICULAR PURPOSE, REGARDING THE SOFTWARE. BROTHER'S LICENSOR(S) DOES NOT WARRANT, GUARANTEE OR MAKE ANY REPRESENTATIONS REGARDING THE USE OR THE RESULTS OF THE USE OF THE SOFTWARE IN TERMS OF ITS CORRECTNESS, ACCURACY, RELIABILITY, CURRENTNESS OR OTHERWISE. THE ENTIRE RISK AS TO THE RESULTS AND PERFORMANCE OF THE SOFTWARE IS ASSUMED BY YOU. THE EXCLUSION OF IMPLIED WARRANTIES IS NOT PERMITTED BY SOME STATES IN THE USA AND SOME PROVINCES IN CANADA. THE ABOVE EXCLUSION MAY NOT APPLY TO YOU.

IN NO EVENT WILL BROTHER'S LICENSOR(S) BE LIABLE TO YOU FOR ANY CONSEQUENTIAL, INCIDENTAL OR INDIRECT DAMAGES (INCLUDING DAMAGES FOR LOSS OF BUSINESS PROFITS, BUSINESS INTERRUPTION, LOSS OF BUSINESS INFORMATION, AND THE LIKE) ARISING OUT OF THE USE OR INABILITY TO USE THE SOFTWARE EVEN IF BROTHER'S LICENSOR HAS BEEN ADVISED OF THE POSSIBILITY OF SUCH DAMAGES. BECAUSE SOME STATES IN THE USA AND SOME PROVINCES IN CANADA DO NOT ALLOW THE EXCLUSION OR LIMITATION OF LIABILITY FOR CONSEQUENTIAL OR INCIDENTAL DAMAGES, THE ABOVE LIMITATIONS MAY NOT APPLY TO YOU. IN ANY EVENT BROTHER'S LICENSOR'S LIABILITY TO YOU FOR ACTUAL DAMAGES FROM ANY CAUSE WHATSOEVER, AND REGARDLESS OF THE FORM OF THE ACTION (WHETHER IN CONTRACT, TORT (INCLUDING NEGLIGENCE), PRODUCT LIABILITY OR OTHERWISE), WILL BE LIMITED TO \$50.

Compilation and Publication Notice

Under the supervision of Brother Industries Ltd., this manual has been compiled and published, covering the latest product descriptions and specifications.

The contents of this manual and the specifications of this product are subject to change without notice.

Brother reserves the right to make changes without notice in the specifications and materials contained herein and shall not be responsible for any damages (including consequential) caused by reliance on the materials presented, including but not limited to typographical and other errors relating to the publication.

BROTHER ONE YEAR LIMITED WARRANTY and EXCHANGE SERVICE (For USA Only)

This warranty gives you certain rights and you may also have other rights that may vary from state to state.

This warranty is given only to the first end-use purchaser of the accompanying product (referred to in this warranty as "this Product").

What is covered: Brother warrants to you for the Warranty Period that there are no defects in the materials, workmanship or Year 2000 compliance of this Product. The "Warranty Period" is 1 year from the date you purchased this product. The "Warranty Period" for consumable items, such as Ink Cartridges, Print Heads, etc. is 90 days from the date of purchase, or the rated life of the Consumable item, whichever is shorter.

What is NOT covered: This warranty is VOID -- that is, this Product has no warranty -- if: (1) you did not purchase this Product from an authorized Brother reseller within the United States, (2) this Product has been serviced, modified or tampered with by anyone other than an Authorized Service Representative of Brother, (3) the serial number has been modified, defaced or removed from this Product, (4) this Product has been abused or damaged, (5) non Brother[®]-brand or non Brother approved parts, supplies, power supplies or other accessories have been used with this Product, or (6) this Product has been transported without the proper preparation and packaging.

What to do if you think your Product is defective:

Call our Customer Service Hotline at 1-800-284-4329, or if you suspect a defect in materials or workmanship in this Product, you can report it to a Brother Authorized Service Center. During the Warranty Period, supply Brother's representative with a copy of your dated bill of sale showing that this Product was purchased within the United States. For the name of your Brother Authorized Service Center, call 1-800-521-2846. After contacting the Brother Authorized Service Center, you may be required to deliver or send the

Product properly packaged, freight prepaid, to the Authorized Service Center together with a photocopy of your bill of sale.

What Brother will do: Brother (or its Authorized Service Center) will evaluate your report of a possible defect to determine whether a defect exists, and if it does exist, Brother (or its Authorized Service Center) will repair or (at Brother's option) replace the Product with a product that performs the same functions and performs as well as the original Product. Brother reserves the right to supply refurbished or remanufactured replacement parts provided that the replacement parts conform to the manufacturer's specifications for new products. The repaired or replacement product will be returned to you at no cost.

Exchange Service:

When an exchange is authorized, Brother will exchange your non-working product with a refurbished or remanufactured product that conforms to the manufacturer's specifications for new products. The refurbished or remanufactured Product you receive will be covered by the balance of the limited warranty period remaining on the original Product, plus an additional thirty (30) days. You will keep the replacement Product that is sent to you and must return (or be billed up to the cost of a new product) your original non- working product, which shall become the property of Brother. You must call Brother Customer Service and if the representative cannot correct the product's malfunction over the telephone and you elect the exchange service, you must provide information pertaining to this Product and you must also provide a valid major credit card number. Your credit card will be charged up to the cost of a new Product if: (i) you do not return your original Product to Brother within five (5) business days; (ii) the malfunctions of your original Product are not covered by the limited warranty; (iii) the proper packaging instructions are not followed and has caused damage to the product;

BROTHER ONE YEAR LIMITED WARRANTY and EXCHANGE SERVICE (For USA Only)

or (iv) the warranty period on your original Product has expired or has not been sufficiently validated with a copy of the proof of purchase (bill of sale). The Brother Customer Service Representative will ship the exchange Product via next business day delivery courier service, with return instructions and prepaid return air bill. Follow the return instructions. You must return the original Product in the same shipping carton in which the exchanged Product was received and include a copy of proof of purchase (bill of sale). Retain your original accessory items and a copy of the return air bill, signed by the courier.

Limitations:

Repair or replacement as described above is your sole and exclusive (that is, your only) remedy if this Product is defective. Brother is not responsible for damage to or loss of any equipment, media, programs or data related to the use of this Product. Except for that repair or replacement, *Brother shall not be liable for any direct, indirect, incidental or consequential damages or specific relief. Because some states do not allow the exclusion or limitation of consequential or incidental damages, the above limitation may not apply to you.*

THIS WARRANTY IS GIVEN IN LIEU OF ALL OTHER WARRANTIES, WRITTEN OR ORAL, WHETHER EXPRESSED BY AFFIRMATION, PROMISE, DESCRIPTION, DRAWING, MODEL OR SAMPLE. ANY AND ALL WARRANTIES OTHER THAN THIS ONE, WHETHER EXPRESS OR IMPLIED, INCLUDING IMPLIED WARRANTIES OF MERCHANTABILITY AND FITNESS FOR A PARTICULAR PURPOSE, ARE HEREBY DISCLAIMED.

This Limited Warranty is the only warranty that Brother is giving for this Product. It is the final expression and the exclusive and only statement of Brother's obligations to you. It replaces all other agreements and understandings that you may have with Brother or its representatives.

This Limited Warranty (and Brother's obligation to you) may not be changed in any way unless you and Brother sign the same piece of paper in which we (1) refer to this Product and your bill of sale date, (2) describe the change to this warranty and (3) agree to make that change.

Product Support: Toll-free customer service and technical support is available for hardware operational assistance at 1-800-284-4329. At any time, free technical support in the form of Frequently Asked Questions, troubleshooting tips and service center locator is available through our fax-back system at 1-800-521-2846 or Brother's Internet Web Site (www.brother.com). Now you can visit us on-line (www.brothermall.com), your complete source for genuine Brother Accessories and Supplies.

**BROTHER INTERNATIONAL CORPORATION
100 SOMERSET CORPORATE BLVD.
BRIDGEWATER, NEW JERSEY 08807-0911**

Please record your model and serial numbers and your date and location of Purchase below for your records. Keep this information with your proof of purchase (bill of sale) in case your Product is lost, stolen or requires service.

Model # _____

Serial # _____

Date of purchase: _____

Store where purchased: _____

Location of store: _____

Important: We recommend that you keep all original packing materials, in the event that you ship this product.

**BROTHER MULTIFUNCTION CENTER/FACSIMILE MACHINE
LIMITED WARRANTY
(For Canada Only)**

Pursuant to this limited warranty of 1 year from the date of purchase for labour and parts, Brother International Corporation (Canada) Ltd. ("Brother"), or its Authorized Service Centers, will repair this MFC/Facsimile machine free of charge if defective in material or workmanship. This Limited Warranty does not include cleaning, consumables (including, without limitation, print cartridges, print head, toner and drum) or damage caused by accident, neglect, misuse or improper installation or operation, any damage caused from service, maintenance, modifications, or tampering by anyone other than a Brother Authorized Service Representative, or from the use of supplies or consumable items that are non-Brother products. Operation of the MFC/Facsimile machine in excess of the specifications or with the Serial Number or Rating Label removed shall be deemed abuse and all repairs thereafter shall be the sole liability of the end-user/purchaser. In order to obtain warranty service, the MFC/Facsimile machine must be delivered or shipped freight prepaid by the end user/purchaser to a "Brother" Authorized Service Center, together with your Proof of Purchase in the form of a Sales Receipt.

For laser products: Failure to remove the Toner Cartridge (and Toner Drum Unit on applicable models) during shipping will cause severe damage to the MFC/Facsimile and will VOID the Warranty. (Refer to your Operation Manual for proper packaging.)

For ink-jet products: Do not remove the ink cartridges during shipping. Damage to your print head resulting from packing without the ink cartridges will VOID your warranty. (Refer to your Operation Manual for proper packaging.)

BROTHER DISCLAIMS ALL OTHER WARRANTIES EXPRESSED OR IMPLIED INCLUDING, WITHOUT LIMITATION, ANY IMPLIED WARRANTIES OF MERCHANTABILITY OR FITNESS FOR A PARTICULAR PURPOSE, EXCEPT TO THE EXTENT THAT ANY WARRANTIES IMPLIED BY LAW CANNOT BE VALIDLY WAIVED.

No oral or written information, advice or representation provided by Brother, its Authorized Service Centers, Distributors, Dealers, Agents or employees, shall create another warranty or modify this warranty. This warranty states Brother's entire liability and your exclusive remedy against Brother for any failure of the MFC/Facsimile machine to operate properly.

Neither Brother nor anyone else involved in the development, production, or delivery of this MFC/Facsimile machine shall be liable for any indirect, incidental, special, consequential, exemplary, or punitive damages, including lost profits, arising from the use of or inability to use the product, even if advised by the end user/purchaser of the possibility of such damages. Since some Provinces do not allow the above limitation of liability, such limitation may not apply to you.

This Limited Warranty gives you specific legal rights and you may also have other rights which vary from Province to Province.

Warranty Service is available at Brother Authorized Service Centers throughout Canada. For Technical Support or for the name and location of your nearest Authorized Service Center call 1-800-853-6660. Within Montreal, please call 685-6464. Internet support: support@brother.ca or browse Brother's Web Site: www.brother.com

Brother International Corporation (Canada) Ltd.
1 Rue Hôtel de Ville
Dollard-Des-Ormeaux, QC H9B 3H6

We're at your side.
brother®



Quick Reference Guide

Sending Faxes

Automatic Transmission

- 1 Place the original face down in the ADF.
- 2 Enter the fax number using One Touch, Speed Dial, Search or the dial pad.
- 3 Press **Start**.

Sending a Cover Page

- 1 Place the original face down in the ADF.
- 2 Press **Function, 1, 3, 1**.
- 3 When **NEXT FAX ONLY?** appears, press **Set**.
- 4 Press or to select **ON** (or **OFF**) and press **Set**.
- 5 Press or to select a comment and press **Set**.
- 6 Enter two digits to indicate the number of pages being sent and press **Set**.
- 7 Press **1** to select additional settings—**OR**—Press **2** if you are ready to fax.
- 8 Enter the fax number.
- 9 Press **Start**.

Real Time Transmission

You can send faxes in real time.

- 1 Place the original face down in the ADF.
- 2 Press **Function, 1, 3, 9**.
- 3 Press or to select **ON** and press **Set**—**OR**—For the next transmission only, press or to select **NEXT FAX ONLY** and press **Set**.

- 4 For the next fax only, press or to select **ON** and press **Set**.
- 5 Press **1** to select additional settings—**OR**—Press **2** to fax.
- 6 Enter the fax number.
- 7 Press **Start**.

Receiving Faxes

Select Receive Mode

Press **Receive Mode** to select **FAX/TEL**, **TAD**, **MANUAL**, or **FAX ONLY**. If you select **FAX/TEL**, make sure to set Ring Delay and F/T Ring Time.

Manual Reception

- 1 Pick up the handset.
- 2 Press **Start** if you hear fax tones (beeps).
- 3 When the screen displays **RECEIVE**, replace the handset.

Storing Numbers

Storing One Touch Dial Numbers

- 1 Press **Function, 1, 5, 1**.
- 2 Press the One Touch key where you want to store the number.
- 3 Enter a number (up to 20 digits) and press **Set**.
- 4 Enter a name (or leave it blank) and press **Set**.
- 5 Press or to select **FAX**, **TEL**, or **FAX/TEL** and press **Set**.
- 6 Press **Stop**.

Storing Speed Dial Numbers

- 1 Press **Function, 1, 5, 2**.



- 2 Enter a two-digit Speed Dial number and press **Set**.
- 3 Enter a number (up to 20 digits) and press **Set**.
- 4 Enter a name (or leave it blank) and press **Set**.
- 5 Press ◀ or ▶ to select **FAX**, **TEL**, or **FAX/TEL** and press **Set**.
- 6 Press **Stop**.

Telephone Operation

One Touch Dialing / Speed Dialing

- 1 Pick up the handset.
 - 2 When you hear the dial tone, press the One Touch key of the location you want to call—**OR**—Press **Search/Speed Dial**, press **#**, then press the two-digit Speed Dial number.
 - 3 To hang up, replace the handset.
- ### Search/Speed Dial
- 1 Press **Search/Speed Dial**, then enter the first letter of the name you're looking for.
 - 2 Press ◀ or ▶ to search the memory.
 - 3 When the name is displayed, lift the handset.
 - 4 Press **Start** to dial.
 - 5 To hang up, replace the handset.

Making Copies

Making a Single Copy

- 1 Place the original face down in the ADF.
- 2 Press **Mono Copy** or **Color Copy**, then wait for five seconds—**OR**—Press **Mono Copy** or **Color Copy** again. (Make sure it's the same key you pressed before.)

Making Multiple Copies

- 1 Place the original face down in the ADF.
- 2 Press **Mono Copy** or **Color Copy**.
- 3 Use the dial pad to enter the number of copies you want.
- 4 Wait five seconds—**OR**—Press **Mono Copy** or **Color Copy**. (Make sure it's the same key you pressed in Step 2.)

Sorting Multiple Copies (Black and White Copy only)

- 1 Place the original face down in the ADF.
- 2 Press **Mono Copy**.
- 3 Press **Options**.
- 4 Press ◀ or ▶ to select **COPY:OPTIONS** and press **Set**.
- 5 Press ◀ or ▶ to select **SORT** and press **Set**.
- 6 Press **Mono Copy**.
- 7 Use the dial pad to enter the number of copies you want.
- 8 Press **Mono Copy**.

Brother fax-back system :
1-800-521-2846

Brother Web Site :
<http://www.brother.com>

Brother Accessories & Supplies:
USA: 1-888-879-3232 (voice)
1-800-947-1445 (fax)
<http://www.brothermall.com>

Brother Accessories & Supplies:
From within Canada:
1-800-668-2768 (voice)

Table of Contents

1

Introduction	1-1
Using This Manual	1-1
Finding Information.....	1-1
Conventions Used in this Manual.....	1-1
Test Sheet Procedures (For USA Only)	1-2
MFC 7300C and MFC 7400C Control Panel Overview	1-3
About Fax Machines	1-5
Fax Tones and Handshake.....	1-5
ECM (Error Correction Mode).....	1-5

2

Assembly and Connections	2-1
Packing List.....	2-1
Choosing a Location.....	2-2
Assembly.....	2-3
Installing the Ink Cartridges	2-7
Important.....	2-8
Connecting the MFC	2-10
Connecting an External Telephone	
Answering Device (TAD).....	2-10
Sequence	2-10
Connections.....	2-11
Outgoing Message (OGM)	2-12
Special Line Considerations	2-12
Roll Over Phone Lines.....	2-12
Two-Line Phone System.....	2-12
Converting Telephone Wall Outlets	2-13
Installing MFC, External Two-Line TAD, and	
Two-Line Telephone	2-13
Multi-Line Connections (PBX).....	2-14
If you are installing the MFC to work with a PBX:.....	2-14
Custom Features on a Single Line.....	2-15

3

Paper	3-1
About Brother Paper.....	3-1
Paper Specifications for Cassette	3-2
Print Area.....	3-3

4

On-Screen Programming.....	4-1
User-Friendly Programming.....	4-1
Function Mode.....	4-1
Alternating Displays.....	4-2
Function Selection Table.....	4-2
1. Fax Functions.....	4-2
2. Printer Functions.....	4-5
3. Copy Functions.....	4-5
4. Video Functions.....	4-6
5. PhotoCapture Center™ Function (For MFC 7400C only).....	4-6

5

Initial Setup.....	5-1
Getting Started.....	5-1
Setting Station ID.....	5-1
Entering Text.....	5-2
Inserting spaces.....	5-2
Making corrections.....	5-2
Repeating letters.....	5-2
Special characters and symbols.....	5-3
Setting Tone/Pulse Dialing Mode (For Canada only).....	5-3
Setting Beeper Volume.....	5-3
Choosing the Handset Volume.....	5-4
Setting Volume Amplify.....	5-5
Setting the Speaker Volume.....	5-5
Setting the Ring Volume.....	5-5
Memory Storage.....	5-5
Turning On Automatic Daylight Savings Time.....	5-6

6

Setup Receive.....	6-1
Basic Receiving Operations.....	6-1
To select or change your Receive Mode.....	6-2
Setting Ring Delay.....	6-2
Setting F/T Ring Time (For FAX/TEL Mode only).....	6-3
Easy Receive.....	6-3
Printing a Reduced Incoming Document.....	6-4
Recommended Reductions.....	6-4
Setting Paper Size.....	6-5
Advanced Receiving Operations.....	6-5
For FAX/TEL Mode only.....	6-5
Changing Remote Codes.....	6-6

Printing a Fax in Memory.....	6-6
Polling.....	6-6
Setting Up Polling Receive.....	6-7
Setting Up Sequential Polling Receive.....	6-7
Canceling a Scheduled Job.....	6-8
Distinctive Ring.....	6-8
Registering the Distinctive Ring Pattern.....	6-9
Caller ID.....	6-10
Viewing Caller ID List.....	6-10
Printing Caller ID List.....	6-10
Call Waiting Caller ID.....	6-11

7

Setup Send	7-1
Before You Begin.....	7-1
Using the ADF (Automatic Document Feeder).....	7-1
Sending Faxes with Multiple Settings.....	7-2
Resolution.....	7-2
Contrast.....	7-2
Manual Transmission	7-3
Automatic Transmission.....	7-3
Color Fax transmission.....	7-3
Manual and Automatic Fax Redial.....	7-3
Dual Access (Not Available for Color Fax).....	7-4
Real Time Transmission.....	7-4
Checking the Job Status.....	7-5
Canceling a Job in Memory.....	7-5
Basic Sending Operations	7-6
Composing Electronic Cover Page.....	7-6
Composing Your Own Comments.....	7-6
Cover Page For Next Fax Only.....	7-7
Always Send Cover Page.....	7-7
Using a Printed Cover Page	7-8
Advanced Sending Operations	7-8
Call Reservation	7-9
Print Sample Call Back Message	7-9
Delayed FAX	
(Not Available for Color Fax).....	7-10
Delayed Batch Transmission	
(Not Available for Color Fax).....	7-10
Multiple Resolution Transmission	
(Not Available for Color Fax).....	7-11

Setting Up Polled Transmit (Not Available for Color Fax).....	7-11
--	------

8

Auto Dial Numbers and Dialing Options	8-1
Storing Numbers for Easy Dialing	8-1
Storing One Touch Dial Numbers	8-1
Storing Speed Dial Numbers	8-2
Changing One Touch and Speed Dial Numbers.....	8-3
Setting Up Groups for Broadcasting	8-4
Dialing Options	8-5
One Touch Dialing	8-5
Speed Dialing	8-5
Access Codes and Credit Card Numbers.....	8-6
Search	8-6
Broadcasting (Not Available for Color Fax)	8-7
Pause.....	8-8
Hold	8-8
Redial.....	8-8
Tone/Pulse (For Canada only).....	8-8

9

Remote Fax Options (Not Available for Color Fax)	9-1
Fax Forwarding/Paging	9-1
Programming a Fax Forwarding Number.....	9-1
Programming Paging Number	9-1
Setting Fax Storage	9-2
Changing Remote Retrieval Access Code.....	9-2
Remote Retrieval	9-3
Using Remote Retrieval Access Code.....	9-3
Remote Commands	9-4
Retrieving Memory Status List	9-5
Retrieving Fax Messages.....	9-5
Changing Fax Forwarding Number.....	9-6

10

Printing Reports	10-1
MFC Settings and Activity.....	10-1
To Print a Report	10-1
Transmission Verification (Xmit) Report.....	10-2
Activity Report Interval.....	10-2

11

Making Copies.....	11-1
Basic Copy Operations.....	11-1
Making Multiple Copies.....	11-1
Memory Full Message.....	11-2
Temporary Copy Settings.....	11-2
Using Enlarge/Reduce Key	11-2
Using the Quality Key	11-3
Using the Options Key	11-4
2in1	11-5
4in1	11-5
Changing Default Copy Settings.....	11-6
Paper Type.....	11-7
Copy Quality	11-7
Color Adjustment	11-7
Copy Contrast.....	11-8
Single Color (One Color)	11-8
Legal Limitations	11-9

12

Walk-Up Video Printing.....	12-1
Getting Started.....	12-1
Auto Switch.....	12-1
Color Video Printing	12-2
Black & White Video Printing	12-2
Temporary Video Print Setting	12-2
Using the Quality Key	12-2
Using the Options Key	12-3
Changing Default Settings	12-5
Paper Type.....	12-6
Video Printing Quality	12-6
Video Type	12-6
Print Size	12-7
Video Printing Color Adjustment.....	12-7
Video Printing Contrast.....	12-8
Video Capture to PC	12-8

13

Walk-Up PhotoCapture Center™ (For MFC 7400C only)	13-1
General Description.....	13-1
Getting Started.....	13-1
DPOF Printing.....	13-2
Printing Thumbnails	13-2

Printing Images.....	13-3
Using the Option Key	13-4
Changing Default Settings.....	13-6
Paper Type.....	13-7
Setting PhotoCapture Center™ Quality	13-7
Photo Brightness.....	13-7
Photo Contrast	13-7
Color Adjustment	13-8
Color Enhancement	13-8

14

Setting Up the MFC and PC to Work Together.....	14-1
Using the Brother Machine with Your PC	14-1
Before You Install Multi-Function Link® Pro.....	14-1
Computer Requirements	14-2
Using a bi-directional IEEE-1284 compliant parallel cable to Connect the MFC to the PC (Using Windows® 95, 98, 98SE, ME, Windows NT® Workstation Version 4.0 and Windows® 2000 Professional)	14-2
Notice to PC User	14-2
How to Attach the Filter Core to a BI-directional Parallel Cable:	14-3
Using Windows® 95, 98, 98SE and ME	14-4
Using Windows® 2000 Professional.....	14-8
Using Windows NT® Workstation Version 4.0	14-12
Using a USB Cable to Connect the MFC to the PC (Using Windows® 98, 98SE, ME and Windows® 2000 Professional Only)	14-17
Notice to Computer Users	14-17
Using Windows® 98, 98SE, ME.....	14-18
Using Windows® 2000 Professional.....	14-24
Installing the Brother Software	14-27
To install Multi-Function Link® Pro (Main Application):.....	14-27
To Install Automatic E-mail Printing (Optional Application):	14-28
To Register Your MFC 7300C/MFC 7400C On-Line (For USA only):.....	14-29
To view On-Line Documentation:	14-29
To Install PhotoPrinter Pro For MFC 7400C only); ...	14-30
To View Brother Support Information:	14-30

Helpful Hints for Windows® 95/98/98SE/ME/ 2000 Professional or Windows NT® 4.0	14-31
Receiving Faxes into the PC (For MFC 7400C only)	14-32

15

Using the MFC as a Printer	15-1
Features	15-1
Printer Driver.....	15-1
Choosing the Right Kind of Paper	15-2
Multi-purpose Sheet Feeder	15-2
Loading Paper.....	15-3
Simultaneous Printing/Fax	15-3
Printer Operation Keys.....	15-4
Reset Key.....	15-4
Ink Management Key	15-4
Turning Off Bi-directional Printing.....	15-4

16

Printer Driver Settings	16-1
Using the Brother MFC 7300C/MFC 7400C Printer Driver....	16-1
The Paper Tab	16-1
Paper Size	16-2
User Defined Paper Size.....	16-3
Orientation	16-3
Copies	16-3
Collate	16-3
Reverse Order	16-4
Paper Thickness.....	16-4
Scaling	16-4
2 in 1	16-4
Paper Source.....	16-4
Feeder.....	16-4
The Quality/Color Tab	16-5
Quality	16-6
Media.....	16-6
Document	16-7
Color/Mono	16-7
Color	16-7
Mono.....	16-7
Color Matching	16-7
Custom Setting	16-8
Halftone Pattern	16-8

True2Life	16-8
-----------------	------

17

Using the Windows®-Based Brother Control Center.....	17-1
Brother Control Center.....	17-1
AutoLoad the Brother Control Center.....	17-2
How to Turn Off AutoLoad.....	17-2
Using the Scan Keys.....	17-2
Using the Control Panel Keys	17-2
Scan Image	17-3
Scan/OCR.....	17-3
Scan to E-mail	17-3
Brother Control Center Features	17-4
Scanning Operations.....	17-4
Copy Operations.....	17-5
PC Fax Operation (For MFC 7400C only).....	17-5
Scanner Settings for Scan, Copy and PC Fax Buttons	17-5
Global Settings	17-5
Setting Up the Scanner Configurations	17-6
To access the Scanner Configurations screen:	17-6
Perform an Operation from the Control Center Screen.....	17-6
Scan to File.....	17-7
Scanner Settings	17-7
Destination Folder	17-8
Send Scan to E-mail	17-8
Scanner Settings	17-9
Email Application.....	17-9
File Attachments.....	17-9
Conversion Options	17-10
Format	17-10
Show QuickSend Menu	17-10
QuickSend List.....	17-10
Send Scan to Word Processor	17-11
Scanner Settings	17-11
Word Processor	17-12
User Defined Button.....	17-13
Scanner Settings	17-13
Target Application.....	17-13
Copy/Two on One Copy.....	17-14
Scanner Settings	17-14
Copy Settings.....	17-14

Send a Fax (For MFC 7400C only).....	17-15
Scanner Settings	17-15
FAX Settings	17-16

18

Using ScanSoft™ PaperPort® for Brother/TextBridge®	18-1
Using ScanSoft™ PaperPort® and TextBridge®	18-1
Viewing Items in ScanSoft™ PaperPort®	18-2
Organizing Your Items in Folders	18-2
Links to Many Other Applications	18-3
Using ScanSoft™ TextBridge® OCR (Converting Image Text to Text You Can Edit)	18-3
Importing Items from Other Applications	18-4
Exporting Items in Other Formats	18-4
Scanning a Document.....	18-4
TWAIN COMPLIANT	18-4
Accessing the Scanner	18-5
Scanning a Document into the PC.....	18-5
Settings in the Scanner Window.....	18-6
Resolution:	18-6
Color Type:	18-6
Size:.....	18-7
Custom:	18-7
Adjust:.....	18-7
Paper:	18-8
Video Capture:	18-8
PreScanning an Image	18-8
How to use PreScan to adjust an image:.....	18-8
Video Capture from the PC.....	18-10
Connecting Your Video Equipment	18-10
To connect your video equipment:	18-10
Capturing An Image	18-10
To capture a frame as an image:	18-11

19

Using Multi-Function Link® Pro Software	19-1
Introduction	19-1
Brother Resource Manager.....	19-1
MFC Remote Setup	19-2
Multi-Function Link® Pro Main Menu (For MFC 7400C only)	19-3
Sending a Fax from Your PC (For MFC 7400C only).....	19-3

Sending a Fax from the Main Menu	19-4
Sending a Fax from a Windows® Application.....	19-5
Receiving Faxes into the PC	
(For MFC 7400C only)	19-5
Checklist for Your PC	19-5
Viewing Received Faxes	19-6

20

PhotoCapture Center™ (MFC 7400C only)	20-1
Introduction	20-1
PhotoPrinter 2000 Pro	20-2
Overview of Basic Steps	20-2

21

Using Automatic E-Mail Printing.....	21-1
For Windows® 95/98/98SE, ME only	21-1
To Access the On-Line Documentation.....	21-1

22

Using the Brother MFC with a New Power Macintosh® G3, G4 or iMac™/iBook.....	22-1
Set up Your USB Equipped Apple® Macintosh® G3,G4 or iMac™ with Mac OS 8.5/8.51/8.6/9.0	22-1
Notice to Computer Users	22-1
Installing the Brother Printer and Scanner Drivers	22-2
Installing PaperPort®	22-2
Using Brother Printer driver with your Apple® Macintosh®	22-3
Using Brother TWAIN Scanner Driver with Your Apple® Macintosh®	22-5
Accessing the Scanner.....	22-6
Scanning a Document into Your Macintosh G3, G4 or iMac	22-6
Settings in the Scanner Window.....	22-7
Image.....	22-7
Resolution.....	22-7
Color Type.....	22-7
Scanning Area	22-8
Business Card Size.....	22-8
Miscellaneous.....	22-9
Brightness.....	22-9
Contrast	22-9
Color Sync Dialog.....	22-9
Scanner Profile	22-10
PreScanning an Image	22-11

Important Information	23-1
Standard Telephone and FCC Notices	23-1
Federal Communications Commission (FCC)	
Declaration of Conformity (For USA only).....	23-3
Industry Canada Compliance Statement	
(For Canada only).....	23-3
ENERGY STAR® Compliance Statement	23-3
Important Safety Instructions.....	23-3
Trademarks	23-5

Troubleshooting and Routine Maintenance	24-1
Troubleshooting	24-1
Frequently Asked Questions (FAQs)	24-1
Brother Bulletin Board	24-1
Error Messages	24-2
Document Jam	24-3
Printer Jam or Paper Jam	24-4
If You Are Having Difficulty with Your MFC	24-6
How to Improve Print Quality.....	24-8
Cleaning the Print Head.....	24-8
Aligning Ink Cartridges	24-9
Turning Off Bi-directional Printing.....	24-10
Packing and Shipping the MFC	24-10
Routine Maintenance.....	24-12
Cleaning the MFC Printer Platen	24-13
Replacing the Ink Cartridges	24-13

Glossary.....	G-1
----------------------	------------

Specifications	S-1
Product Description	S-1
Fax	S-1
Printer	S-2
Controller.....	S-3
Print Media	S-3
Consumable Items	S-3

Index.....	I-1
-------------------	------------

Remote Retrieval Access Card.....	R-1
--	------------

1 Introduction

Using This Manual

Thank you for purchasing a Brother Multi-Function Center (MFC). This MFC has been designed to be simple to use, with LCD screen prompts to guide you through functions. However, you can use your MFC to its fullest potential by taking a few minutes to read this manual.

Finding Information

All chapter headings and subheadings are listed in the Table of Contents. You will be able to find information about a specific feature or function by checking the Index in the back of this manual.

Conventions Used in this Manual

Throughout this manual you'll see special symbols alerting you to important information, warnings, and actions to perform. For added clarification, illustrations of some screen displays will help you choose the correct key presses.

boldface	Bold typeface identifies a specific key on the FAX/MFC control panel.
<i>italics</i>	Italics typeface emphasize an important point, or refer you to related topic.
bubble dot	Bubble Dot typeface identifies the messages on the LCD of the FAX/MFC.



Warnings detail precautions you must take to avoid possible personal injury.



Cautions specify procedures you must follow or avoid to prevent possible damage to the FAX/MFC.



Notes tell you the proper response for a situation that may occur.



FYI tips provide details about how the current operation interacts with other features.



Improper Setup alerts you to devices and procedures that are not compatible with the FAX/MFC.

Test Sheet Procedures (For USA Only)

After programming your Station ID, please fill out the TEST SHEET included with your MFC and fax it to Brother's Automated Fax Response System as your first transmission. This will verify that your MFC is properly installed. (See *Setting Station ID*, page 5-1.)

When this document is received, a confirmation sheet will be sent back to your MFC. In order to receive a response, be sure to set up your Station ID.

USA 1-908-685-9283 (fax)

MFC 7300C and MFC 7400C Control Panel Overview

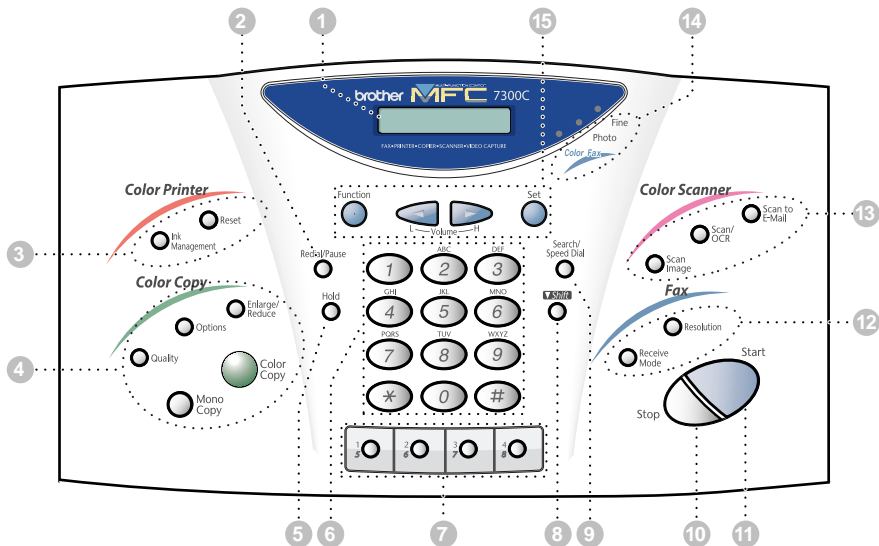

1 Liquid Crystal Display (LCD)

LCD displays messages to help you set and operate your MFC.

2 Redial/Pause

Redials the last number called. Also inserts a pause in autodial numbers.

3 Color Printer Keys:

Ink Management

Cleans the ink print heads and/or resets the ink dot counter after replacing an ink cartridge.

Reset

Clears data from the printer memory, and then resets and restores to the factory default settings.

4 Color Copy Keys:

Enlarge/Reduce

Lets you reduce or enlarge copies depending on the ratio you select.

Options

You can change the setting of Copy, Video printing and PhotoCapture Center™ (For MFC 7400C only).

Quality

Use this key to temporarily change the quality for Copy and Video Printing and PhotoCapture Center™ (For MFC 7400C only).

Mono Copy

Makes a black-and-white or single-color copy.

Color Copy

Makes a full-color copy.

5 Hold

Lets you put calls on hold.

6 Dial Pad

Dials phone and fax numbers, and can be used as a keyboard for entering information into the MFC. (Only for Canada: # key lets you switch the dialing type during a telephone call from "PULSE" to "TONE".

7 One Touch Keys

These 4 keys give you instant access to previously stored phone numbers.

8 Shift

To access memory locations 5 through 8 in the One Touch keys hold down the **Shift** key.

9 Search/Speed Dial

Lets you look up numbers stored in the dialing memory. Also lets you dial stored phone numbers by pressing a # and a two-digit number.

10 Stop

Stops a fax, cancels an operation, or exits from function mode.

11 Start

Starts an operation, such as sending a fax.

12 Fax Keys:

Receive Mode

Use to select how the MFC will handle incoming calls.

Resolution

Sets the resolution when you send a fax.

13 Color Scanner Keys:

Scan Image

Press this key to scan a color picture into your graphics application for viewing and editing.

Scan/OCR

Press this key to start scanning a text document. ScanSoft™ TextBridge® will convert it to editable text and display it in your word processor application for further editing.

Scan to E-mail

Press this key to start scanning an original into your E-mail application, setting it up automatically as an attachment.

14 Resolution Indicator Lights

These LEDs show the resolution mode you selected.

15 Programming Keys:

Function

Lets you access the function and programming mode.

 **(Left Arrow)**

 **(Right Arrow)**

Volume

Moves the LCD cursor to the left or right. Adjusts speaker, ring and handset volume.

Set

Stores a function setting in the MFC. Also use this key whenever you want to broadcast faxes to many different locations, maximum of 158 locations at once.

About Fax Machines

If you're a first-time fax machine user, fax operation might seem a little mysterious. Soon, you'll recognize the unusual fax tones on your phone line, and be able to send and receive faxes easily.

Fax Tones and Handshake

When someone is sending a fax, the MFC sends fax calling tones, (CNG tones)—soft, intermittent beeps at 4-second intervals. You'll hear them when you dial and press **Start**, and they continue for about 40 seconds after dialing. During that time, the sending machine must begin the “handshake” with the receiving machine. Each time you use automatic procedures to send a fax, you are sending CNG tones over the phone line. You'll soon learn to listen for these soft beeps each time you answer a phone on your MFC line, so you can know if you are receiving a fax message.

The receiving fax responds with fax receiving tones—loud, chirping sounds. A receiving fax chirps for about 40 seconds over the phone line, and the screen displays RECEIVE. If your MFC is set to the FAX mode, it will answer every call automatically with fax receiving tones. Even if the other party hangs up, your MFC continues to send the “chirps” for about 40 seconds, and the screen continues to display RECEIVE.

When your MFC answers in FAX/TEL mode, the MFC listens for CNG tones and then responds with receiving tones.

The fax “handshake” is the time in which the sending machine's CNG tones and the receiving machines “chirps” overlap. This must be for at least 2 to 4 seconds, so the fax machines can understand how each is sending and receiving the fax. The handshake cannot begin until the call is answered, and the CNG tones only last for about 40 seconds after the number is dialed. Therefore, it's important for the receiving machine to answer the call in as few rings as possible.

Note

When you have an external telephone answering device (TAD) on your MFC line, your TAD will determine the number of rings before the call is answered. Pay special attention to the directions in the Installation chapter for connecting a TAD to your MFC.

ECM (Error Correction Mode)

The Error Correction Mode (ECM) is a way for the MFC to check the integrity of a fax transmission while it is in progress. ECM transmissions are possible only between machines that both have the ECM feature. If they do, you may send and receive fax messages that are continuously checked for their integrity.

Sufficient memory must be available in your MFC for this feature to work.

2

Assembly and Connections

Packing List

Make sure you have the following items:



Caution

Do NOT throw away the filter cores and cable ties by accident. You will need them to meet FCC Emission Requirements when you connect the MFC to your computer using USB cable and bi-directional IEEE-1284 compliant parallel cable.



If an item is missing, call Brother Customer Service at 1-800-284-4329 (USA), 1-800-853-6660 (from within Canada) or 1-514-685-6464 (from within Montreal). See Ordering Accessories and Supplies on page ii for the correct item numbers.



Whenever you transport the MFC, use the packing materials that came with your MFC. If you do not pack the MFC correctly, you may void your warranty.

Choosing a Location

Place your MFC on a flat, stable surface, such as a desk. Select a place that is free of vibration and shocks. Locate the MFC near a telephone jack and a standard, grounded power outlet. Choose a location where the temperature remains between 50°F and 95°F (10°–35°C).



Avoid placing your MFC in a high-traffic area. Do not place near heaters, air conditioners, water, chemicals, or refrigerators. Do not expose the MFC to direct sunlight, excessive heat, moisture, or dust. Do not connect your MFC to electrical outlets controlled by wall switches or automatic timers. Disruption of power can wipe out information in the MFC's memory. Do not connect your MFC to electrical outlets on the same circuit as large appliances or other equipment that might disrupt the power supply. Avoid interference sources, such as speakers or the base units of cordless phones.

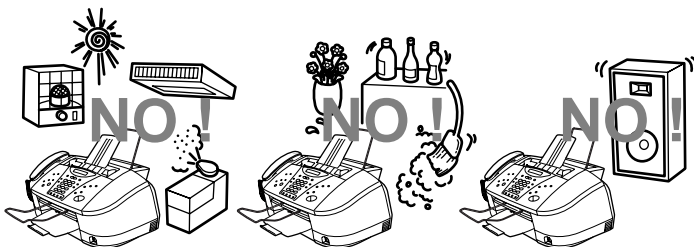

WARNING

- Never install telephone wiring during a lightning storm.
- We recommend that this product be used with a surge protection device to protect the product against lightning storms.
- Never install a telephone jack in a wet location unless the jack is specifically designed for a wet location.
- Never touch telephone wires or terminals that are not insulated unless the telephone line has been disconnected at the network interface.
- Use caution when installing or modifying telephone lines.
- Avoid using a telephone (other than a cordless type) during an electrical storm. There may be a remote risk of electric shock from lightning.

- Do not use the telephone to report a gas leak in the vicinity of the leak.
- For PLUGGABLE EQUIPMENT, the socket-outlet should be installed near the equipment and should be easily accessible.
- To reduce the risk of shock or fire, use only a No. 26 AWG or larger telecommunications line cord.

Assembly

- 1 Connect the handset.**
Connect the curled handset cord to the MFC and the other end to the handset.
- 2 Connect the power cord.**
There is no ON/OFF switch. When you plug in the power cord, the power goes on and the screen alternately displays.



WARNING

- The MFC must be grounded using a 3-prong plug.
 - Since the MFC is grounded through the power outlet, you can protect yourself from potentially hazardous electrical conditions on the telephone network by keeping the power to your MFC on when you connect it to a telephone line. Similarly, you can protect yourself when you want to move your MFC, by disconnecting the telephone line first, and then the power cord.
 - Lightning and power surges can damage this product! We recommend that you use a quality surge protection device on the AC power line as well as on the telephone line, or unplug the lines during a lightning storm.
- 3 Connect the telephone line cord.**
Connect one end of the telephone line cord to the jack on the MFC and the other end to a modular wall jack.

Caution

Operating the MFC before you install the ink cartridges will permanently damage the print head.

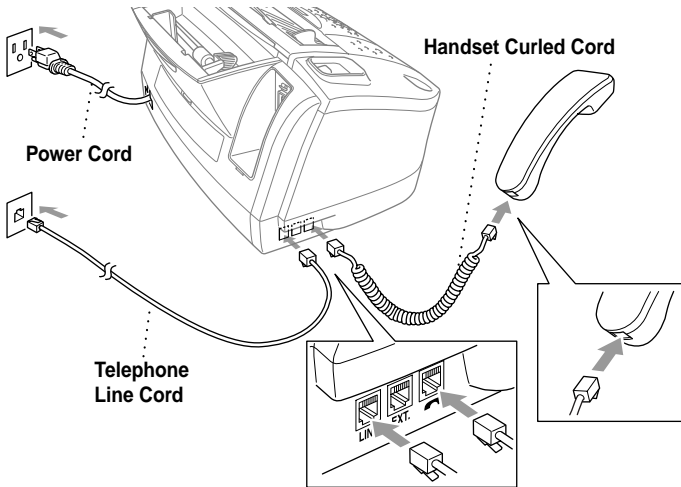

4 Attach the paper wire extension to the multi-purpose sheet feeder.

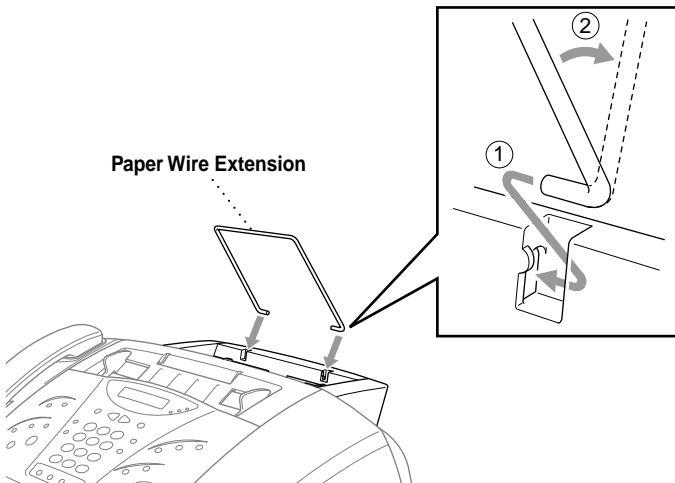

5 Attach the plastic document support.

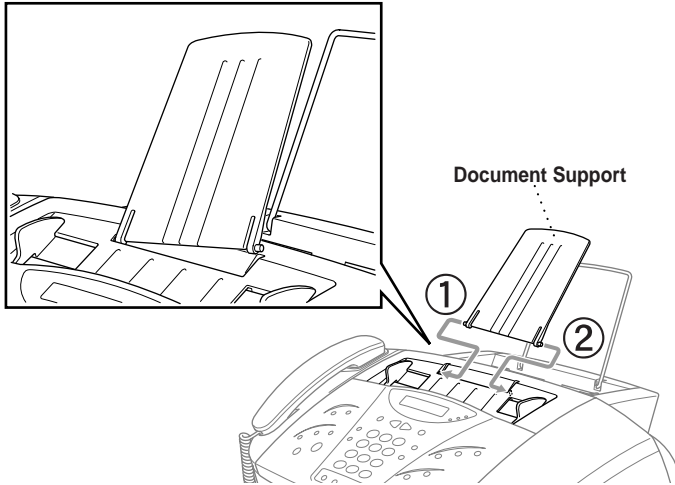

6 Attach the paper tray to the paper output slot, and pull out the plastic extension.

! Caution

Please attach the paper tray to prevent paper jams and maintain print quality.

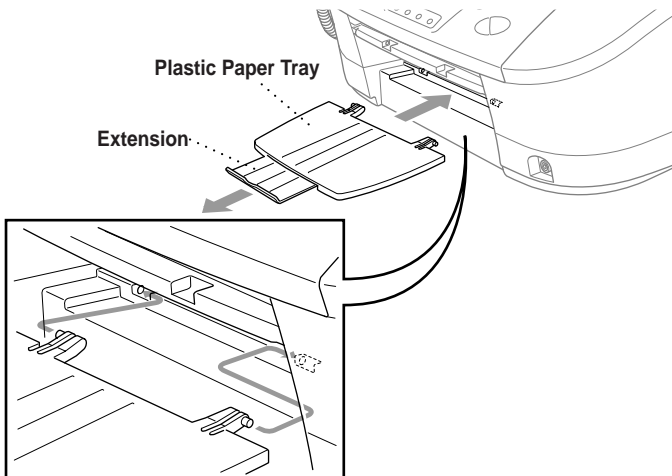

7 Attach the document wire extension.

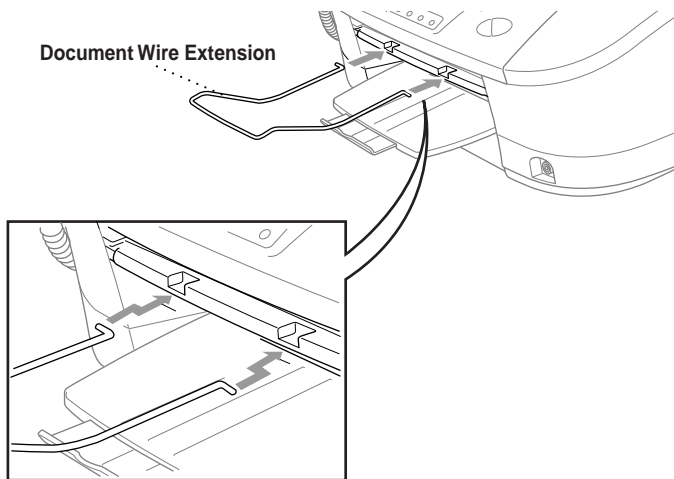

8 Load paper in the multi-purpose sheet feeder (paper cassette).

- A** Fan the paper well. Gently insert the paper. Make sure the print side is toward you and the paper level is stacked below the paper guide line.

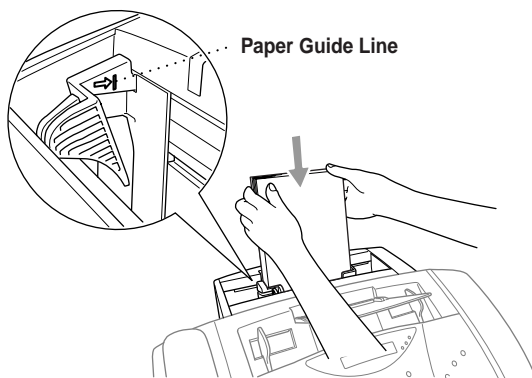

- B** Adjust the guide to fit the paper width.

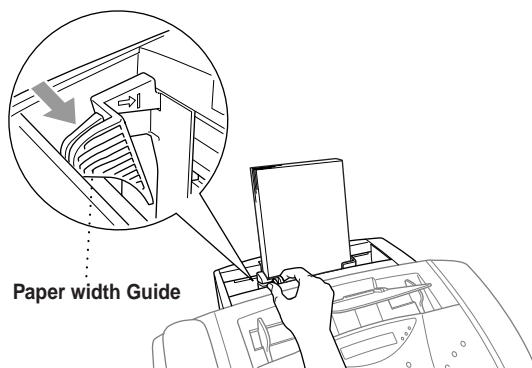

Installing the Ink Cartridges

- 1 Check that you turned on the power (by plugging in the power cord). The screen alternately displays



- 2 Open the control panel cover by pulling it toward you (①), then lift the top cover toward the back (②). After a few seconds, the print head will move left to its replacement position.

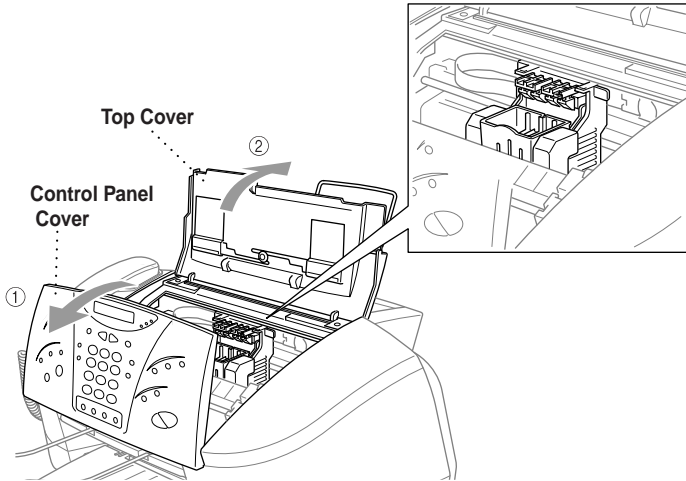

- 3 Remove the yellow shipping cover by pulling it toward you and lifting it up and out.

! Caution

- The bottom of the yellow shipping cover is wet with ink that will cause stains, so wipe it clean before you place it down. Keep the yellow shipping cover in a safe place. You will need it in the future when you replace the print head.

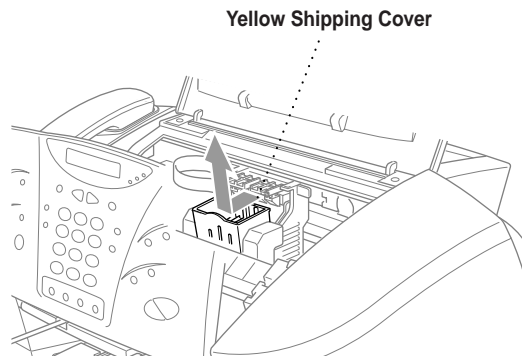

We recommend that you install the ink cartridges from left to right in this order: Black, Yellow, Cyan, Magenta.

- 4 Open the Black ink cartridge bag and remove the ink cartridge.
- 5 Carefully remove the sealing tape from the bottom of the ink cartridge. Be sure to peel the tape in the direction *away* from you.

Important

To prevent spilling ink and staining your hands and clothing, peel the sealing tape gently and slowly. Do not touch the ink opening on the cartridge or the removed tape.

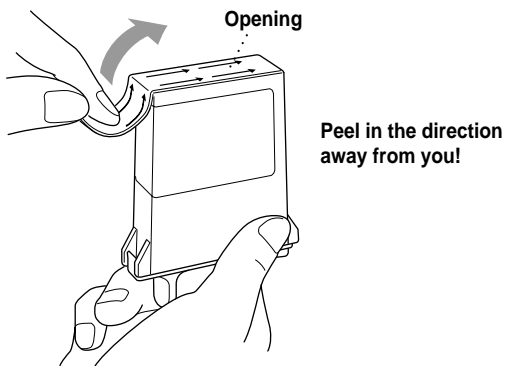

- 6 Each color has its own correct position. Match the markings of the color indicators on the cartridge holder as a guide. Then, gently insert the Black ink cartridge by tilting it toward you and then pressing it backward until it *clicks* into place.

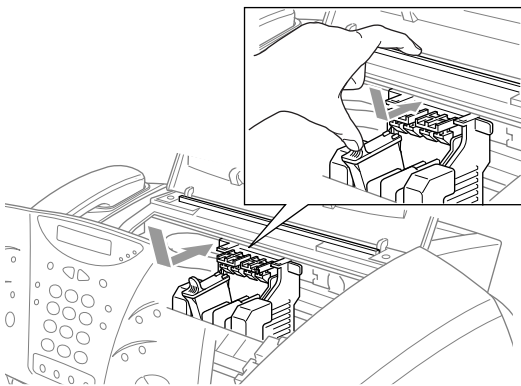

- 7 Repeat Steps 4–6 to install each color ink cartridge.
- 8 After installing all ink cartridges, close the top cover and control panel cover until they click into place. Your MFC enters a “head cleaning” cycle for approximately 6 minutes. The MFC goes online to set the ink dot counter for each color, so the MFC can warn you with an error message when ink is running low.

! Caution

Make sure the paper is loaded in the multi-purpose sheet feeder. The LCD displays **CLEANING BLACK**. After the cleaning cycle is finished, the LCD shows **PRESS START KEY**.

- 9 Press **Start** within one minute. The MFC starts printing the Test Sheet. (Only during initial ink cartridge installation) The LCD shows: **PRINT OK?**
1. YES 2. NO

- 10 Check the print quality of the test sheet. If it is not good, clean the print head again by pressing **2**. The screen will ask you if the print quality is OK for each color. Press **2** for any color with a problem. You can choose several colors. After cleaning is finished, press **Start**. The MFC starts printing Test Sheet No. 2.

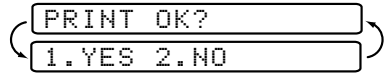

- 11 Adjust the Vertical Alignment by following the instructions printed on the Test Print page.

! WARNING

If ink gets in your eyes, irrigate them with water immediately and if irritation occurs, consult a doctor.

! Caution

- DO NOT remove ink cartridges if you do not need to replace them. If you do so, it may reduce the ink quantity and the MFC will not know the quantity of ink left in the cartridge.
- DO NOT shake the ink cartridges. If you do so, the ink may spill when you take off the sealing tape. If ink stains your body or clothing, wash with soap or detergent immediately.
- If you install an ink cartridge in the wrong color position, you must clean the print head several times after correcting the cartridge installation and before you start printing because the colors were mixed.
- Once you open an ink cartridge, install it in the MFC and use it up within six months of installation. Use unopened ink cartridges by the expiration date written on the cartridge package.
- DO NOT refill the ink cartridges. Attempting to use refilled cartridges may cause damage to the print head and will void your warranty.



If the **INK EMPTY** error message is on the screen display after you have installed the ink cartridges, check and make sure that the ink cartridges are installed correctly.

Connecting the MFC

Connecting an External Telephone

Your MFC is equipped with a handset that you can use as a regular phone. However, you can also connect a separate telephone (or telephone answering device) directly to your MFC.

Connect the modular plug on the telephone's line cord to the jack labeled EXT. on the back side of the MFC.

Whenever this phone (or TAD) is in use, the LCD displays **EXT. TEL IN USE**, and, if the fax handset is lifted, an alarm sounds. To disconnect the call on the external phone and switch to the fax, press **Hold**.

The external telephone cannot be used while a function is being performed on the control panel.

Connecting an External Telephone Answering Device (TAD)

Sequence

You might choose to connect an answering system.

When you have an **external TAD** on the same telephone line as the MFC, the TAD answers all calls. The MFC "listens" for fax calling (CNG) tones. If it hears them, the MFC takes over the call and receives the fax. If it doesn't hear CNG tones, the MFC lets the TAD continue playing your outgoing message so your caller can leave you a voice message.

The TAD must answer within four rings (the recommended setting is two rings). The MFC cannot hear CNG tones until the TAD has answered the call, and with four rings there are only 8–10 seconds of CNG tones left for the fax "handshake." Make sure you carefully follow instructions in this manual for recording your outgoing message. Do not use a "toll-saver" ring setting on the TAD.



If You Subscribe to your Telephone Company's Distinctive Ring Service:

You may connect an external TAD to a separate wall jack *only* if you subscribe to your telephone company's Distinctive Ring service, have registered the distinctive ring pattern on your machine, use that number as a fax number and set your machine's Answer mode to **MANUAL**.



If You Do Not Subscribe to Distinctive Ring Service:

You *must* plug your TAD into the EXT. jack of your Brother machine. If your TAD is plugged into a wall jack, both your machine and the TAD will try to control the phone line. (See illustration on page 2-11.)



Do not connect a TAD elsewhere on the same phone line. (unless you have the Distinctive Ring service.)

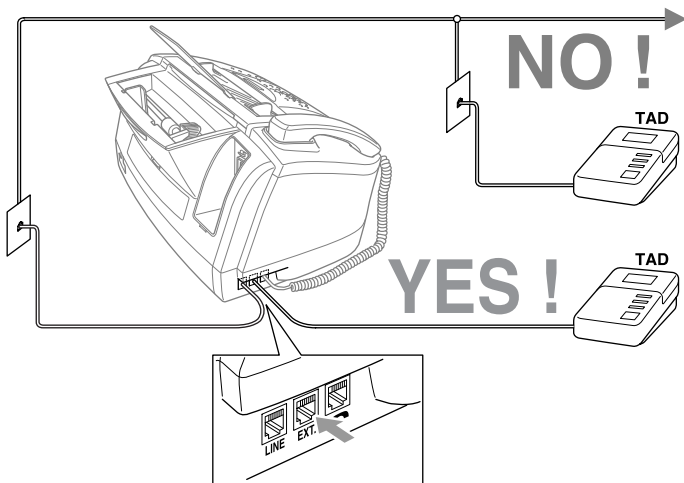

Connections

The external TAD **must** be plugged into the left side of the MFC, into the jack labeled EXT. Your MFC cannot work properly if you plug the TAD into a wall jack.

- 1 Plug the telephone line cord from the wall jack into the left side of the MFC, in the jack labeled LINE.
- 2 Plug the telephone line cord from your external TAD into the left side of the MFC, in the jack labeled EXT. (Make sure this cord is connected to the TAD at the TAD's telephone line jack, and not its telephone set jack.)
- 3 Set your external TAD to four rings or less. (The MFC's Ring Delay setting does not apply).
- 4 Record the outgoing message on your external TAD (see below).
- 5 Set the TAD to answer calls.
- 6 Set the Receive Mode to TAD:ANSWER MACH.

Outgoing Message (OGM)

Timing is important in recording this message.

- 1 Record 5 seconds of silence at the beginning of your message. (This allows your MFC time to listen for the fax CNG tones of automatic transmissions before they stop.)
- 2 Limit your speaking to 20 seconds.
- 3 End your 20-second message by giving your Fax Receive Code for people sending manual faxes. For example:
“After the beep, leave a message or send a fax by pressing * 51 and press Start.”

Special Line Considerations

Roll Over Phone Lines

A roll over phone system is a group of two or more separate telephone lines that pass incoming calls each other if they are busy. The calls are usually passed down or “rolled over” to the next available phone line in a preset order.

Your MFC can work in a roll over system as long as it is the last number in the sequence, so the call cannot roll away. Do not put the MFC on any of the other numbers; when the other lines are busy and a second fax call would be received, the fax call is transferred to a line that does not have a fax machine. **Your MFC will work best on a dedicated line.**

Two-Line Phone System

A two-line phone system is nothing more than two separate phone numbers on the same wall outlet. The two phone numbers can be on separate jacks (RJ11) or combined into one jack (RJ14). Your MFC must be plugged into an RJ11 jack. RJ11 and RJ14 jacks may be equal in size and appearance and both may contain four wires (black, red, green, yellow). To test the type of jack, plug in a two-line phone and see if it can access both lines. If it can, you must separate the line for your MFC. (See *Easy Receive*, page 6-3.)

Converting Telephone Wall Outlets

There are three ways to convert to an RJ11 jack. The first two ways may require assistance from the telephone company. You can change the wall outlets from one RJ14 jack to two RJ11 jacks. Or, you can have an RJ11 wall outlet installed and slave or jump one of the phone numbers to it.

The third way is the easiest: Buy a triplex adapter. You can plug a triplex adapter into an RJ14 outlet. It separates the wires into two separate RJ11 jacks (Line 1, Line 2) and a third RJ14 jack (Lines 1 and 2). If your MFC is on Line 1, plug the MFC into L1 of the triplex adapter. If your MFC is on Line 2, plug it into L2 of the triplex adapter.

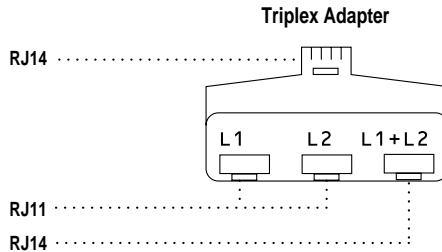

Installing MFC, External Two-Line TAD, and Two-Line Telephone

When you are installing an **external** two-line telephone answering device (TAD) and a two-line telephone, your MFC must be isolated on one line at both the wall jack and at the TAD. *The most common connection is to put the MFC on Line 2.* The two-line TAD must have two telephone jacks: one labeled L1 or L1/L2, and the other labeled L2, which is our assumption in the following Steps. You will need at least three telephone line cords, the one that came with your MFC and two for your external two-line TAD. You will need a fourth line cord if you add a two-line telephone.

- 1 Place the two-line TAD and the two-line telephone next to your MFC.
- 2 Plug one end of the telephone line cord for your MFC into the L2 jack of the triplex adapter. Plug the other end into the LINE jack on the left side of the MFC.
- 3 Plug one end of the first telephone line cord for your TAD into the L1 jack of the triplex adapter. Plug the other end into the L1 or L1/L2 jack of the two-line TAD.

- 4 Plug one end of the second telephone line cord for your TAD into the L2 jack of the two-line TAD. Plug the other end into the EXT. jack on the left side of the MFC.

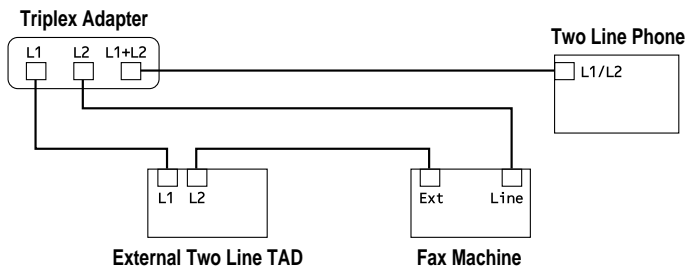

You can keep two-line telephones on other wall outlets as always. There are two ways to add a two-line telephone to the MFC's wall outlet. You can plug the telephone line cord from the two-line telephone into the L1+L2 jack of the triplex adapter. Or, you can plug the two-line telephone into the TEL jack of the two-line TAD.

Multi-Line Connections (PBX)

Most offices use a central telephone system. While it is often relatively simple to connect the machine to a key system or a PBX (Private Branch Exchange), we suggest that you contact the company that installed your telephone system and ask them to connect the MFC for you. It is advisable to have a separate line for the MFC. You can then leave the MFC in FAX mode to receive faxes any time of day or night.

If the MFC is to be connected to a multi-line system, ask your installer to connect the unit to the last line on the system. This prevents the unit from being activated each time a telephone call is received.

- ⊘ As with all fax units, this machine must be connected to a two wire system. If your line has more than two wires, proper connection of the MFC cannot be made.

If you are installing the MFC to work with a PBX:

- 1 It is not guaranteed that the unit will operate correctly under all circumstances with a PBX. Any cases of difficulty should be reported first to the company that handles your PBX.
- 2 If all incoming calls will be answered by a switchboard operator, it is recommended that the Receive Mode be set to MANUAL. All incoming calls should initially be regarded as telephone calls.
- 3 The MFC may be used with either pulse or tone dialing telephone service (Only For Canada only).

Custom Features on a Single Line

To learn how custom features may affect your faxing operations, see Chapter 24, *Troubleshooting and Routine Maintenance*.

3 Paper

The quality of your document can be affected by the kind of paper you use in the MFC. You can use plain paper, coated paper, transparencies, glossy paper, organizer paper, and envelopes. We recommend testing various papers before purchasing large quantities. For best results, use Brother special coated paper, glossy paper, and transparencies. (See page ii for information about ordering Brother accessories).



When you print on coated paper, transparencies, and glossy paper, be sure to select the correct media in the “Quality/Color” tab in the printer driver. When using coated paper, transparencies or glossy paper, avoid stacking by removing each page after copying or printing.

About Brother Paper

Brother paper is manufactured specifically for this MFC, to provide optimum print quality.

High Quality Coated Paper for Color Ink Jet printing—super fine mode (BP72CL for letter)

Color Ink Jet Transparencies—fine mode (BPTRL for letter)

Color Ink Jet Glossy Paper—superfine mode (BPGLL for letter)

- For optimum output quality, we recommend you use only genuine Brother paper.
- Brother coated (ink jet) paper is coated only on one side. Therefore, when loading paper in the paper cassette, make sure that the whiter side (the coated side) is facing up.
- The coated side of glossy paper is shiny. Do not touch the shiny side. Load glossy paper in the feeder with the shiny side facing up toward you.
- DO NOT touch the coated side of the paper or both sides of Transparencies, because it absorbs water and perspiration easily, and might cause decreased output quality.
- For optimum output quality, be sure to use paper appropriate for your resolution setting.
- Store paper in the original bag, and keep it sealed. Keep the paper flat and away from moisture and direct sunlight and heat.
- Transparencies designed for laser printers/copiers may stain your next document. Use only recommended transparencies.

Paper Specifications for Cassette

Paper Type	Paper Size	Cassette Capacity
Cut Sheet	Letter, Executive	100 Sheets of 20 lb (75 g/m ²)
	Legal	100 Sheets of 20 lb (75 g/m ²)
Coated Paper	Letter	50 Sheets
Transparencies	Letter	20
Glossy Paper	Letter	20
Envelopes	DL, COM-10, C5, B5, Monarch	10
Organizer	K, L	10
Photo	4"x6"	10
Postcard	5"x7"	30
<p>Paper Capacity for Feeder:</p> <p>Cut Sheet Paper Weight 17 to 32 lb (64 to 120 g/m²)</p> <p>Sheet Feeder: Up to 0.43 inches (11mm) / Approximately 100 sheets of 20 lb (75 g/m²)</p> <p>Output Stacker: Approximately 50 Sheets of 20 lb (75 g/m²)</p> <p>Transparencies and glossy paper must be picked up from the paper tray one page at a time.</p>		

- For fax reception paper size, see page 6-4.

Print Area

The Print Area depends on the settings in the application you are using. The figures below show the unprintable areas on cut sheets and envelopes.

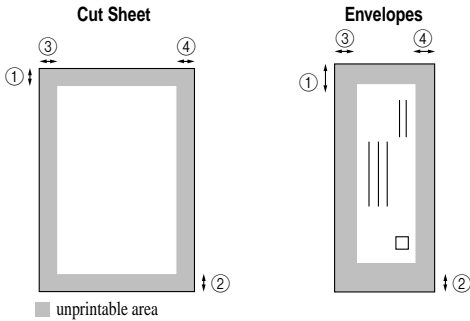

(inch)

Paper Type	Paper Size		①	②	③	④
Cut Sheet	Letter, Legal	Fax	0.12	0.43	0.16	0.16
		Mono Copy				
		Color Copy				0.24
		Printer				0.34
	Executive	Printer	0.12	0.43	0.13	0.13
Organizer	K, L	Printer	0.12	0.43	0.13	0.13
Envelopes		Printer	0.39	0.79	0.13	0.13

*Printer depends on the Printer driver.



Do not use the following types of paper and envelopes:

- Damaged, curled, wrinkled, or irregularly shaped paper and envelopes
- Extremely shiny or highly textured paper and envelopes
- Envelopes with clasps
- Envelopes of baggy construction
- Envelopes not sharply creased
- Embossed envelopes
- Paper and envelopes already printed with a laser printer
- Envelopes preprinted on the inside
- Paper and envelopes that cannot be arranged uniformly when stacked

4 On-Screen Programming

User-Friendly Programming

We have designed your Multi-Function Center with on-screen programming. User-friendly programming helps you take full advantage of all the functions your MFC has to offer. (See *Using This Manual*, page 1-1.)

Since your programming is done on the LCD, we created step-by-step on-screen prompts to help you program your MFC. All you need to do is follow the prompts as they guide you through the function menu selections and programming options and settings.

Function Mode

You can access the Function Mode by pressing **Function**. The screen displays:

Then press **1** for Fax Functions—**OR**—press **2** for Printer Functions—**OR**—press **3** for Copy Functions—**OR**—press **4** for Video Functions—**OR**—press **5** for PhotoCapture Center™ Functions (For MFC 7400C only).

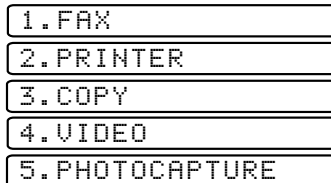

When you enter the Function Mode, your MFC displays a list of Level One Functions from which you can choose. These function options appear one after the other on the display. Select an option by pressing **Set** when the option appears on the LCD.

You can “scroll” more quickly through options by pressing **▶**. When the screen displays your selection, press **Set**. Use **◀** to scroll backward if you passed your choice or to save key strokes. Both arrow keys show all options, in the opposite order. When you finish a function, the screen displays ACCEPTED.



If you want to exit the Function Mode, press **Stop**.

Alternating Displays

When you see alternating displays, the LCD sometimes alternates between the currently selected option, and a help message giving brief instructions about how to proceed. The display you'll probably see most often is shown below. It appears when you place an original in the ADF to tell you that you can dial a number and send a fax, or you can make a copy.



Function Selection Table

You can probably perform most of these programming settings without the Owner's Manual. To help you understand the function selections, options and settings that are found in the MFC programs, use the Function Selection Table below.

1. Fax Functions

1. INITIAL SETUP			
Function	Description	Factory Setting	Page
1. DATE/TIME	Enter date and time for the LCD display and heading on fax transmissions.	2001 1/1 00:00	5-1
2. STATION ID	Program your name, fax number and telephone number to appear on each transmitted page.	—	5-1
3. BEEPER	Adjust volume level of beeper.	LOW	5-3
4. VOLUME AMPLIFY	For the hearing-impaired, you can set the volume to the VOL AMPLIFY:ON setting on a permanent or temporary basis.	OFF	5-5
5. AUTO DAYLIGHT	Changes for Daylight Savings Time automatically.	OFF	5-6
6. TONE/PULSE (For Canada only)	Selects dialing mode.	TONE	5-3
7. LOCAL LANGUAGE (For Canada only)	Allows you to change the LCD Language to French.	ENGLISH	See French Manual

2. SETUP RECEIVE			
Function	Description	Factory Setting	Page
1. RING DELAY	Number of rings before MFC answers in FAX/TEL, FAX, MANUAL, or TAD mode.	RING DELAY: 04	6-2
2. F/T RING TIME	Sets the time for “double ring” in FAX/TEL mode.	20	6-3
3. EASY RECEIVE	Receive fax messages without pressing the Start key.	ON	6-3
4. REMOTE CODE	Personalize the codes to activate and deactivate the MFC from a remote location.	ON (✕51, #51)	6-5
5. REDUCTION	Reduces size of image.	AUTO	6-4
6. PAPER	Selects size of paper for received faxes.	LETTER	6-5
7. POLLING RX	Sets up your MFC to poll another fax machine.	OFF	6-6

3. SETUP SEND			
Function	Description	Factory Setting	Page
1. COVERPG SETUP	Automatically sends a cover page you program.	OFF	7-6
2. COVERPAGE MSG	Programs customized message for fax cover page.	—	7-6
3. CONTRAST	Changes lightness or darkness of a fax you are sending.	AUTO	7-2
4. RESOLUTION	Allows you to change resolutions page by page.	STANDARD	7-11
5. OVERSEAS MODE	Adjusts for sometimes difficult overseas transmissions.	OFF	7-8
6. CALL RESERVE	Sends a fax, then speak.	OFF	7-9
7. DELAYED FAX	Sends documents later.	—	7-10
8. POLLED TX	Sets up your MFC with a document to be retrieved by another fax machine.	OFF	7-11
9. REAL TIME TX	You can send a fax without using memory.	OFF	7-4
0. BATCH TX	Sends all delayed faxes that are to the same fax number and at the same time as one transmission.	OFF	7-10

4. REMAINING JOBS

Function	Description	Factory Setting	Page
	Checks which jobs are in memory or cancel a delayed fax or polling job.		6-8, 7-5

5. SET AUTO DIAL

Function	Description	Factory Setting	Page
1. ONE-TOUCH DIAL	Dials numbers stored in memory by pressing only one key.	—	8-1
2. SPEED-DIAL	Dials numbers stored in memory by pressing only four keys.	—	8-2
3. SETUP GROUPS	Sets up a Group number for broadcasting.	—	8-4

6. PRINT REPORTS

Function	Description	Factory Setting	Page
1. XMIT REPORT		OFF	10-2
2. ACT. REPORT		INTERVAL: OFF	10-2
3. AUTO DIAL		—	10-1
4. TEL. INDEX	Print lists and reports of activity.	—	10-1
5. HELP	(Details in Chapter 10.)	—	10-1
6. USER SETTINGS		—	10-1
7. MEMORY STATUS		—	10-1
8. ORDER FORM		—	10-1

7. REMOTE FAX OPT

Function	Description	Factory Setting	Page
1. FAX FWD/PAGING	Sets MFC to forward fax messages— OR —to call your pager.	OFF	9-1
2. FAX STORAGE	Stores incoming faxes in memory for remote retrieval.	OFF	9-2
3. REMOTE ACCESS	Personalizes code for retrieving faxes.	159✳	9-2
4. PRINT FAX	Prints incoming faxes stored in the memory.	—	6-6

0. TEL SERVICE			
Function	Description	Factory Setting	Page
1. DISTINCTIVE	Uses the phone company Distinctive Ring subscriber service to register the ring pattern with the MFC.	OFF	6-8
2. CALLER ID	View or print a list of the last 30 Caller IDs stored in memory.	—	6-10

2. Printer Functions

Function	Description	Factory Setting	Page
1. TEST PRINT	Use these functions when you need to adjust the print quality.	—	24-8
2. VERTICAL ALIGN		—	24-9
3. BI-DIR PRINT		ON	15-4

3. Copy Functions

Function	Description	Factory Setting	Page
1. PAPER TYPE	Identifies the type of paper in the cassette.	PLAIN PAPER	11-7
2. QUALITY	Selects Draft, Normal, High or Photo copy quality.	NORMAL	11-7
3. COLOR ADJUST	Adjusts the amount of Red, Green, or Blue in copies.	—	11-7
4. CONTRAST	Adjusts the contrast.	—	11-8
5. ONE COLOR	Selects a single color to use, instead of Black, when you use the Mono Copy key.	OFF=Black	11-8

4. Video Functions

Function	Description	Factory Setting	Page
1. PAPER TYPE	Identifies the type of paper in the cassette.	PLAIN PAPER	12-6
2. QUALITY	Selects Normal or High print.	NORMAL	12-6
3. VIDEO TYPE	Selects Moving or Still video signal.	MOVING	12-6
4. PRINT SIZE	Selects the size you want the captured frame to print.	4"x3"	12-7
5. COLOR ADJUST	Adjusts the amount of Red, Green, or Blue in video printing.	—	12-7
6. CONTRAST	Adjusts the contrast.	—	12-8

5. PhotoCapture Center™ Function (For MFC 7400C only)

Function	Description	Factory Setting	Page
1. PAPER TYPE	Identifies the type of paper in the cassette.	PLAIN PAPER	13-7
2. QUALITY	Selects Normal, High or Photo print.	HIGH	13-7
3. BRIGHTNESS	Adjusts the brightness.	—	—
4. CONTRAST	Adjusts the contrast.	—	—
5. COLOR ADJUST	Adjusts the amount of Red, Green or Blue in color printing.	—	13-8
6. TRUE2LIFE	Adjusts white balance, sharpness and chroma of an image.	—	—

5 Initial Setup

Getting Started

Setting Date and Time

Your MFC displays the date and time, and prints it on every fax you send.

In the event of a power failure, you may have to reset the date and time. All other settings remain unaffected.

- 1 Press **Function, 1, 1, 1**.
- 2 Enter the last two digits of the year and press **Set**.
- 3 Enter two digits for the month (for example, enter 09 for September, or 10 for October) and press **Set**.
- 4 Enter two digits for the day (for example, 06) and press **Set**.
- 5 Enter the time in 24-hour format (for example, enter 15:25 for 3:25 PM) and press **Set**.
- 6 Press **Stop**.
The LCD now displays the date and time you set, and displays it whenever the MFC is in Standby mode.

Setting Station ID

You can store your name, fax number, and telephone number to be printed on all fax pages that you send. (See *Composing Electronic Cover Page*, page 7-6.)

- 1 Press **Function, 1, 1, 2**.
 - 2 Enter your fax number (up to 20 digits) and press **Set**. You must enter a fax number to proceed.
 - 3 Enter your telephone number (up to 20 digits) and press **Set**.
If your telephone number and fax number are the same, enter the same number again.
-  The telephone number you enter is used only for Call Back Message and Cover Page features.
- 4 Use the dial pad to enter your name (up to 20 characters), and press **Set**.
(See *Entering Text*, page 5-2.)

5 Press **Stop**.

The screen returns to the date and time.



If your Station ID has already been programmed, the screen prompts “1” to make a change, or “2” to exit without changing.

Entering Text

When you are setting certain functions, such as the Station ID, you may need to enter text into the MFC. Most number keys have three or four letters printed above them. The keys for 0, #, and * don't have printed letters because they are used for special characters.

By pressing the appropriate number key the correct number of times, you can access the character you want.

Press Key	one time	two times	three times	four times
2	A	B	C	
3	D	E	F	
4	G	H	I	
5	J	K	L	
6	M	N	O	
7	P	Q	R	S
8	T	U	V	
9	W	X	Y	Z

Inserting spaces

To enter a space, press  once between numbers and twice between characters.

Making corrections

If you entered a letter incorrectly and want to change it, press  to move the cursor after the last correct letter. Then press **Stop**; all letters above and to the right of the cursor are deleted. Re-enter the correct text and/or digits. You can also back up and type over incorrect letters.

Repeating letters

If you need to enter a character assigned to the same key as the previous character, press  to move the cursor to the right.

Special characters and symbols

Press *****, **#** or **0** repeatedly to move the cursor under the special character or symbol you want, then press **▶** to select it.

Press ***** for (space) ! “ # \$ % & ’ () * + , - . /

Press **#** for ; < = > ? @ [] ^ _

Press **0** for É À È Ê Î Ç Ë Ö 0

NOTICE

The Telephone Consumer Protection Act of 1991 makes it unlawful for any person to use a computer or electronic device to send any message via a telephone fax machine unless such messages clearly contain, in a margin at the top or bottom of each transmitted page, or on the first page of the transmission, the date and time it is sent and an identification of the business or other entity or other individual sending the message and the telephone number of the sending machines or such business, other entity or individual.

In order to program this information into your fax machine, complete the steps described on page 5-1.



If you do not enter a fax number, no additional information can be entered.

Setting Tone/Pulse Dialing Mode (For Canada only)

Your fax machine comes set to accommodate tone (multi-frequency) dialing service.

If you have pulse (rotary) dialing service, you need to change the dialing mode.



- 1 Press **Function, 1, 1, 6**.
- 2 Press **◀** or **▶** to select TONE or PULSE and press **Set**.
- 3 Press **Stop** to exit.

DIALING: TONE?

DIALING: PULSE?

Setting Beeper Volume



You can set the beeper to LOW, HIGH or OFF. The default setting is **LOW**. When the beeper is set to LOW or HIGH, the MFC beeps every time you press a key or make an error, and at the end of fax sending or receiving.

- 1 Press **Function, 1, 1, 3**.
- 2 Press  or  to select your setting.
- 3 When the screen displays the setting you want, press **Set**.
- 4 Press **Stop** to exit.



Choosing the Handset Volume

Before you begin to use the machine, you must decide if you need to set the handset volume to AMPLIFY:ON for a user who is hearing-impaired. The AMPLIFY volume level complies with FCC standards.



VOLUME AMPLIFY: OFF

*This default setting is appropriate if **none** of the users are hearing-impaired. During a conversation, users can press Volume  or  on the control panel to adjust the volume to LOW or HIGH. When the handset is replaced, the handset volume will remain until you change it again.*



VOLUME AMPLIFY: ON—TEMPORARY

This setting is appropriate if some of the users are hearing-impaired. During a conversation, users can press Volume  or  on the control panel to adjust the volume to LOW, HIGH or AMPLIFY. When the handset is replaced, the handset volume returns to the default setting of LOW.

VOLUME AMPLIFY:ON—PERMANENT

Choose VOL AMPLIFY:ON—PERMANENT if all of the users are hearing-impaired. During a conversation, users can press Volume  or  on the control panel to adjust the volume to LOW, HIGH or AMPLIFY. When the handset is replaced, the handset volume returns to the default setting of AMPLIFY.



When you press Volume  or  on the control panel to adjust the volume, the display shows the setting you are choosing. Each key press changes the volume to the next setting.





WARNING

It is important that you do not choose PERMANENT unless all the users are hearing-impaired. Otherwise, the default setting of AMPLIFY may damage the hearing of some users.

Setting Volume Amplify



Please carefully read *Choosing the Handset Volume*, page 5-4 before you do the following steps:

1 Press **Function, 1, 1, 4**.

2 If *none* of the users are hearing-impaired, press  or  to select **VOL AMPLIFY:OFF?** and press **Set**, then go to Step 4—OR—If *some* or *all* of the users are hearing-impaired, select **VOL AMPLIFY:ON?** and press **Set**.



VOL AMPLIFY:ON?
SELECT < -> & SET

3 If all the users are hearing-impaired, press  or  to select **PERMANENT?** and press **Set**—OR—If only *some* of the users are hearing-impaired, select **TEMPORARY?** and press **Set**.



PERMANENT?
SELECT < -> & SET





TEMPORARY?
SELECT < -> & SET

4 Press **Stop** to exit.



Setting the Speaker Volume

You can adjust the speaker volume when your machine is onhook (after the machine is onhook dialing). You can turn the speaker off or you can select a speaker volume level. The default setting is the lowest volume.

Press  or  to adjust the volume level. The display shows the setting you are choosing. Each key press changes the volume to the next setting. The new setting will remain until you change it again.

Setting the Ring Volume

You can adjust the ring volume when your MFC is idle. You can turn the ring **OFF** or you can select a ring volume level.



Press  or  to adjust the volume level. With each key press, the MFC rings so you can hear the current setting and the display shows the setting you are choosing. Each key press changes the volume to the next setting. The new setting will remain until you change it again.

Memory Storage

In the event of a power failure, all settings in the INITIAL SETUP, SETUP RECEIVE, SET AUTO DIAL, REMOTE FAX OPT, plus the COVERPG SETUP and COVERPAGE MSG functions (from SETUP SEND) are stored permanently. You may have to reset the date and time.

Turning On Automatic Daylight Savings Time

You can set the machine to change automatically for Daylight Savings Time by resetting itself forward one hour in the Spring and backward one hour in the Fall.

- 1 Press **Function, 1, 1, 5**.
- 2 Press  or  to select **ON** (or OFF) and press **Set**.
- 3 Press **Stop** to exit.

5.AUTO DAYLIGHT

6 Setup Receive

Basic Receiving Operations

Choosing the Receive Mode

There are four different receive modes for your MFC. You may choose the mode that best suits your needs by pressing **Receive Mode** repeatedly until the screen displays the setting you want to use.

LCD	How it works	When to use it
MANUAL (manual receive)	You control the phone line and must answer every call yourself.	Use this mode when you are using a computer modem on the same line or if you receive very few fax messages. You can also use this mode with Distinctive Ring.
FAX (automatic receive)	The MFC automatically answers every call as a fax.	For dedicated fax lines. You cannot receive a voice call but you can call out.
FAX/TEL* (Fax/Telephone)	The MFC controls the line and automatically answers every call. If the call is a fax it will receive the fax. If the call is not a fax it will ring (double ring) for you to pick up the call.	You cannot have an answering machine on the same line, even if it is on a separate wall jack on the same line. You cannot use the telephone company's Voice Mail in this mode.
TAD:ANSWER MACH. (External Telephone Answering Device)	The external TAD automatically answers every call. Voice messages are stored on the external TAD. Fax messages are printed.	Use this mode if you have an external answering machine on your phone line.

*In FAX/TEL mode you must set the Ring Delay and F/T Ring Time. If you have extension phones on the line, keep the Ring Delay to 4 rings.

To select or change your Receive Mode

- 1 Press **Receive Mode**. The screen displays your current selection.

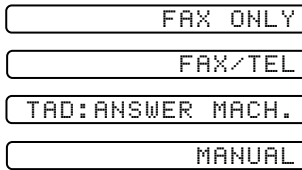

- 2 Continue to press **Receive Mode** until your new selection appears. After 2 seconds, the screen returns to the date and time display, along with your new Receive Mode setting.



If you are changing the Receive Mode while in another operation, the screen returns to that operation.



Current Receive Mode.....

MNL: MANUAL
FAX: FAX ONLY
F/T: FAX/TEL
TAD: EXTERNAL ANSWERING SYSTEM

Setting Ring Delay

The Ring Delay setting determines the number of times the MFC rings before it answers. If you have extension phones on the same line as the MFC, keep the Ring Delay default setting of **4**. (See *Easy Receive*, page 6-3, *Operation from Extension Telephone*, and *For FAX/TEL Mode only*, page 6-5.)

- 1 Press **Function, 1, 2, 1**.
- 2 Press **<** or **>** to select how many times the line rings before the MFC answers (00–04) and press **Set**. If you select 00, the line doesn't ring at all.
- 3 Press **Stop** to exit.

Setting F/T Ring Time (For FAX/TEL Mode only)

If you set the receive mode to FAX/TEL, you'll need to determine how long the MFC will send you its special double ring when you have a voice call. This ringing happens *after* the initial ringing from the phone company. Only the MFC rings, for 20, 30, 40 or 70 seconds; no other phones on the same line ring the special double ring. However, you can answer the call on any extension phone (in a separate wall jack) on the same line as the MFC. (See *Operation from Extension Telephone*, page 6-5.)

- 1 Press **Function, 1, 2, 2**.
- 2 Press ◀ or ▶ to select how long the MFC will ring to alert you that you have a voice call and press **Set**.
- 3 Press **Stop** to exit.

RING TIME: 20 SEC

Now, when a call comes in and the MFC is set to FAX/TEL mode, all phones on this line will ring the number of times you selected in Ring Delay.

You can let the MFC pick up and detect if it's a fax or voice call. If it's a fax call, the MFC prints the fax. If it's a voice call, the MFC signals you with a double ring for the length of time you selected in F/T Ring Time.



Even if the caller hangs up during the double ringing, the MFC continues for the set time.

Easy Receive

When you use this feature, you don't have to press **Start** when you answer a fax call and hear calling beeps. Just hold the handset and wait a few seconds. When you see "RECEIVE" on the fax screen or when you hear "chirps" through the handset of an extension phone connected to another wall jack, just replace the handset, and your MFC does the rest. Selecting **ON** allows the MFC to receive fax calls automatically, even if you lift the handset of an extension or external phone. Selecting **SEMI** lets the MFC receive the call only if you've answered it at the MFC. Selecting **OFF** means you'll have to activate the MFC yourself, by pressing **Start** or by pressing ✕ **5 1** if you are not at your MFC. (See *Operation from Extension Telephone*, 6-5 and *For FAX/TEL Mode only*, 6-5)

If you've set the feature to **ON**, but your MFC doesn't automatically connect a fax call when you lift an external or extension phone handset, press the Fax Receive code ✕ **5 1**. At the MFC, lift the handset and press **Start**.



- 1 Press **Function, 1, 2, 3**.
- 2 Use ◀ or ▶ to select **ON**, **SEMI** or **OFF** and press **Set**.
- 3 Press **Stop** to exit.

Printing a Reduced Incoming Document

You can always reduce the size of an incoming fax to a fixed percentage, regardless of the size of the paper (up to legal) in your MFC. If you choose AUTO, your MFC chooses the level of reduction for you.

1 Press **Function**, **1**, **2**, **5**.

5. REDUCTION

2 Use  or  to select the reduction ratio you want—**AUTO**, **100%**, **88%**, **83%** or **70%** and press **Set**. Choose 100% if you don't want a reduction.

3 Press **Stop** to exit.

Recommended Reductions





If your paper is letter size (8.5" x 11"), and the incoming fax is
letter size, select 88%
A4, select 83%
legal size, select 70%

If your paper is legal size (8.5" x 14"), and the incoming fax is
letter size, select 100%
A4, select 100%
legal size, select 88%

If your paper is A4 (8.2" x 11.6"), and the incoming fax is
letter size, select 100%
A4 size, select 88%
legal size, select 70%

Setting Paper Size

You can use three sizes of paper for printing your faxes — letter, legal and A4. When you change the kind of paper you have loaded in the MFC, you will need to change the setting for paper size, so your MFC will know how to fit the incoming fax on the page. You can also select the level of page reduction to fit on the paper in your MFC.

- 1 Press **Function, 1, 2, 6**.
- 2 Press  or  to select **LETTER, LEGAL** or **A4** and press **Set**.
- 3 Press **1** to change the reduction setting —**OR**—Press **2** to go to Step 5.
- 4 Press  or  to select **AUTO, 100%, 88%, 83%** or **70%** and press **Set**.
- 5 Press **Stop** to exit.



6.PAPER



CHANGE REDUCTION

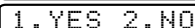

1.YES 2.NO

Advanced Receiving Operations

Operation from Extension Telephone

If you answer a fax call on an extension phone or on an external phone in the EXT. jack, you can make your MFC take over by using the Fax Receive Code. When you press the Fax Receive Code *** 5 1**, the MFC starts to receive a fax. (See *Easy Receive*, page 6-3.)

If the MFC answers a voice call and double-rings for you to take over, use the Telephone Answer Code **# 5 1** to take the call at an extension phone. (See *F/T Ring Time*, page 6-3.)

If you answer a call, and no one is on the line, assume you're receiving a fax. At the MFC phone, press **Start**, then hang up. At an extension phone, press *** 5 1**, wait for fax receiving tones (chirps), then hang up. At an external phone, press *** 5 1** and wait for the phone to be disconnected (the screen displays **RECEIVE**) before you hang up. (Your caller will have to press **Start** to send the fax.)

For FAX/TEL Mode only

When the MFC is in FAX/TEL mode, it will use the F/T Ring Time (double ringing) to alert you to a voice call. If you're at the MFC, you can lift the handset to answer.

If you're at an extension phone, you'll need to lift the handset during the F/T Ring Time and press **# 5 1** between the double rings. If no one is on the line, or if someone wants to send you a fax, send the call back to the MFC by pressing *** 5 1**.

Changing Remote Codes

Remote Codes might not work with some telephone systems. The preset Fax Receive Code is ✕ **5 1**. The preset Telephone Answer Code is **# 5 1**.



If you are always disconnected when accessing your external TAD remotely, try changing the Fax Receive Code from ✕ **5 1** to **###** and the Telephone Answer Code from **# 5 1** to **9 9 9**.

- 1 Press **Function, 1, 2, 4**.
- 2 Press or to select ON (or OFF) and press **Set**.
- 3 If you want to, enter a new Fax Receive Code, then press **Set**.
- 4 If you want to, enter a new Telephone Answer Code, then press **Set**.
- 5 Press **Stop** to exit.

REMOTE ACT.:ON?

FAX RECEIVE:*51

TEL ANSWER:#51

Printing a Fax in Memory

If you have Fax Storage ON for remote retrieval, you can still print a fax in the memory when you are at your MFC. (See *Setting Fax Storage*, page 9-2.)

- 1 Press **Function, 1, 7, 4**.
- 2 Press **Start**.
- 3 After printing is finished, press **Stop** to exit.

Polling

Polling is the process of retrieving faxes from another fax machine. You can use your MFC to “poll” other machines, or you can have someone poll your MFC.

All parties involved in polling need to set up their fax machines to accommodate polling. When someone polls your MFC to receive a fax, they pay for the call; if you poll someone’s fax machine to receive a fax, you pay for the call.



Some fax machines do not respond to the polling function.

Setting Up Polling Receive

Polling Receive is when you call another fax machine to receive a fax from it.

- 1 Press **Function, 1, 2, 7.**



A screen display showing the text "POLLING RX:OFF?" on the top line and "SELECT ← → & SET" on the bottom line. A large right-facing curly bracket is positioned to the right of the two lines.

- 2 Press  or  to choose ON and press **Set.**



A screen display showing the text "ENTER FAX NO." on the top line and "PRESS START KEY" on the bottom line. A large right-facing curly bracket is positioned to the right of the two lines.

- 3 Enter the fax number you are polling.

- 4 Press **Start.**
The screen displays DIALING.



Setting Up Sequential Polling Receive

Your MFC can request documents from several fax units in a single operation. Afterward, a Sequential Polling Report will be printed.

- 1 Press **Function, 1, 2, 7.**



A screen display showing the text "POLLING RX:OFF?" on the top line and "SELECT ← → & SET" on the bottom line. A large right-facing curly bracket is positioned to the right of the two lines.

- 2 Press  or  to select Polling ON and press **Set.**

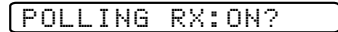

A screen display showing the text "POLLING RX:ON?"

- 3 Specify the destination fax machines you wish to poll, using One Touch, Speed Dial, a Group or the dial pad. You must press **Set** between each location.



A screen display showing the text "ENTER FAX NO." on the top line and "PRESS START KEY" on the bottom line. A large right-facing curly bracket is positioned to the right of the two lines.

- 4 Press **Start.**

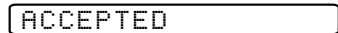

A screen display showing the text "ACCEPTED"

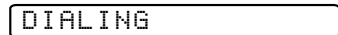

Your MFC will poll each number or group member in turn for a document.



A screen display showing the text "DIALING"

Canceling a Scheduled Job

You can cancel tasks you've scheduled, such as Delayed Fax or Polling Transmit. (See *Checking Job Status*, page 7-5.)

- 1 Press **Function, 1, 4**. Any waiting jobs appear on the display. If no job is waiting, the screen displays "NO JOB WAITING." 
- 2 If you have more than two jobs waiting, press  or  to select the job you want to cancel and press **Set**.
—OR—
If you have only one job waiting, go to step 3.
- 3 Press **1** to cancel—OR—Press **2** to exit without canceling. To cancel another job, return to Step 2.
- 4 Press **Stop** to exit.

Distinctive Ring

This MFC feature lets you use the Distinctive Ring subscriber service offered by some telephone companies, which allows you to have several telephone numbers on one phone line. Each phone number has its own Distinctive Ring pattern, so you'll know which phone number is ringing. This is one way you can have a separate phone number for your MFC.

Your MFC has a Distinctive Ring function, allowing you to dedicate one phone number just for receiving faxes. You'll need to follow the directions below to "register" the new Distinctive Ring pattern, that was assigned by the Telephone Company, so your MFC can recognize its incoming calls. (Call your Telephone Company if you don't know your ring pattern.)



You can change or cancel the Distinctive Ring pattern at any time. You can switch it off temporarily, then turn it back on. When you get a new fax number, make sure you reset this function.













You can register only one Distinctive Ring pattern with the MFC. Some ringing patterns cannot be registered.

- The MFC will answer only calls to its registered number.
- To have your TAD answer only the main number, the MFC must be in Manual Mode.
- In FAX/TEL or FAX mode, the MFC will answer all numbers on the phone line.

Registering the Distinctive Ring Pattern

If you are not sure which ring pattern you have, call your Telephone Company. Then assign that pattern in the steps below.

- 1 Set the MFC to **MANUAL** mode.
- 2 Press **Function, 1, 0, 1**. The screen displays the current setting of this feature.
- 3 Press  or  to select **DISTINCTIVE:SET?** and press **Set**.

- 4 Press  or  to select the prestored ring pattern you want to assign and press **Set**. (You will hear each pattern as you scroll through the four patterns.) Be sure to choose the pattern assigned by the Telephone Company.

Ring Pattern	Rings	
1	long - long	
2	short - long - short	
3	short - short - long	
4	very long (normal pattern)	

- 5 Press **Stop** to exit.

Once you've registered the Distinctive Ring pattern in your MFC, you can turn this feature **ON** or **OFF**. To change the setting, follow steps 1 to 4 above, selecting **ON** or **OFF**.

Caller ID



The Caller ID feature lets you use the Caller ID subscriber service offered by many local phone companies. This service provides you, by means of the screen display, the name or telephone number of your caller as the line rings.

After a few rings, the screen displays the telephone number of your caller (or name, if available). Once you pick up the handset, the Caller ID information disappears from the screen, but the call information remains stored in the Caller ID memory.







- You will see the first 16 characters of the number or name.
- OUT-OF-AREA display means call originates outside your Caller ID service area.
- PRIVATE CALL display means the caller has intentionally blocked transmission of information.
- CALL PICKUP display remains on screen when no Caller ID information was transmitted.

If both the name and number are received, the screen displays only the name. You can print a list of Caller ID information received by your MFC. (See *Printing Caller ID List* below.)



Caller ID service varies with different carriers. Call your local phone company to determine what kind of service is available in your area.

Viewing Caller ID List

Caller ID memory stores information for up to thirty calls; when the thirty-first call comes in, information about the first call is erased. You can scroll through Caller ID information to review those calls made to your MFC.

- 1 Press **Function, 1, 0, 2**.
- 2 Press  or  to select DISPLAY #? and press **Set**.
If the name was not received, it will not be displayed.
- 3 Press  or  to scroll through the Caller ID memory to select the Caller ID you want to view and press **Set**. The screen shows the caller's name and number and the date and time of the call.
- 4 Press  or  to return to the Caller ID listing—**OR**—Press **Stop** to exit.

Printing Caller ID List

- 1 Press **Function, 1, 0, 2**.
- 2 Press  or  to select PRINT REPORT, and press **Set**.
- 3 Press **Start**.

Call Waiting Caller ID

The Call Waiting Caller ID feature lets you use the Call Waiting Caller ID service offered by many local telephone companies. The feature displays the telephone number (or name, if available) of Call Waiting callers on your MFC's screen.

- 1 To answer a Call Waiting signal while you're talking on the phone, ask the other party if you can put them on Hold a minute to catch the other call. The screen displays the Caller ID.
- 2 Press **Search/Speed Dial** to switch to the second call.
- 3 To switch back to the first call, press **Search/Speed Dial** again.



Either caller can hang up at any time. However, if you hang up you will disconnect both callers.

7 Setup Send

Before You Begin

Using the ADF (Automatic Document Feeder)

- Documents must be between 5.8 and 8.5 inches wide, and 5 and 14 inches long.
- Make sure you place originals **face down, top edge first**.
- Adjust the paper guides to fit the width of your document.

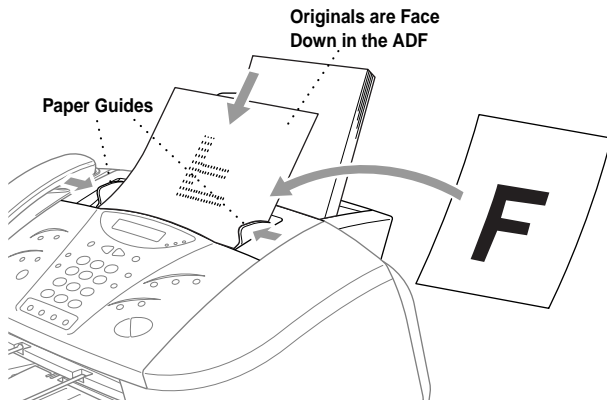

- The automatic document feeder (ADF) can hold up to 20 pages, feeding each one individually through the MFC. Use standard (20 lb/75g/m²) paper when using the ADF.

⊘ **DO NOT** use curled, wrinkled, folded, or ripped paper, or paper with staples, paper clips, paste or tape attached. **DO NOT** use cardboard, newspaper or fabric.

Make sure documents written with ink are completely dry.

Sending Faxes with Multiple Settings

When you send a fax you can choose any combination of the available settings:

add a coverpage and select a comment;
set the contrast or resolution; send using
overseas mode, call reservation, delayed

fax, polling transmission or real time transmission. After each function is accepted, the display will ask if you want to enter other settings:

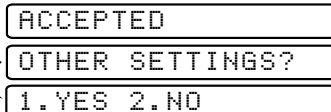

- Press **1** if you want to select additional settings. The display returns to the SETUP SEND menu—**OR**—

Press **2** if you are finished choosing settings, and go to the next step.

Resolution

When you have an original in the ADF, you can use the **Resolution** key to change the default setting. Press **Resolution** continuously until you see the lights change to the setting you want. For standard, turn Fine & Photo lights *off*. (See *Multiple Resolution Transmissions*, page 7-11.)

Standard—For most typed documents. (No lights)

Fine—Good for small print; transmits slower than standard resolution.

Photo—Use when document has varying shades of gray; slowest transmission time.



Color fax—Use to send the original in color.



You can also change the fax resolution to S.Fine. Please see *Multiple Resolution Transmission*, page 7-11.

Contrast

If your original is very light or very dark, you might want to set the contrast accordingly. Use S.LIGHT to send a very light original. Use S.DARK to send a very dark original.

- 1 Place the original face down in the ADF.
- 2 Press **Function, 1, 3, 3**.
- 3 Press  or  to select AUTO, S.LIGHT or S.DARK and press **Set**.
- 4 Press **1** if you want to select additional settings. The display returns to the SETUP SEND menu—**OR**—Press **2** if you are finished choosing settings and go to step 5.
- 5 Enter a fax number
- 6 Press **Start** to send a fax.

Manual Transmission

Manual transmission lets you hear the dial tone, ringing and fax receiving tones before sending the fax.

- 1 Place the original face down in the ADF.
- 2 Pick up the handset and listen for a dial tone.
- 3 Enter the fax number you want to call (you can enter the digits using the dial pad, or you can enter a One Touch or Speed Dial number or you can call using Search). (See *One-Touch Dialing*, page 8-5.)
- 4 When you hear the fax tone, press **Start**.
- 5 Replace the handset.

Automatic Transmission

This is the easiest way to send a fax. **IMPORTANT:** Do **not** pick up the handset.

- 1 Place the original face down in the ADF.
- 2 Enter the fax number using the dial pad, One Touch, Speed Dial or Search. (See *Speed Dialing*, page 8-5.)
- 3 Press **Start**.

Color Fax transmission

Your Multi-Function Center allows you to transmit a color fax.

- 1 Place the original face down in the ADF.
- 2 Press **Resolution** to select the Color Fax.
- 3 Enter the fax number using the dial pad, One Touch, Speed Dial or Search.
- 4 Press **Start**.



When you are sending a color fax, the MFC starts sending the fax without scanning the original into memory.

Manual and Automatic Fax Redial

If you're sending a fax manually and the line is busy, press **Redial/Pause** to retry the number.

If you're sending a fax automatically and the line is busy, the MFC will automatically redial up to three times at 5 minute intervals.

Dual Access (Not Available for Color Fax)

You can scan *up to* 50 documents into the fax memory, even while the machine is receiving or sending another fax (from memory). You can set temporary settings for each fax you're scanning, except Polling.

If you try to scan in and store a 51st fax, the machine will send it immediately, without storing it in memory.



If you get a MEMORY FULL message while scanning the first page of a fax, press **Stop** to cancel scanning. If you get a MEMORY FULL message while scanning in a subsequent page, you'll have the option to press **Start** to transmit the pages scanned so far, or to press **Stop** to cancel the operation.

- 1 Place the original in the ADF.
- 2 Enter the fax number.
- 3 Press **Start**. The machine starts scanning the document and the screen displays the job number (#XX) of the fax and how much memory is available. Then the machine starts dialing. You can immediately repeat steps 1 through 4 for the next fax.



Your machine normally operates in Dual Access mode. However, to send a color fax, you must override Dual Access and use Real Time Transmission.







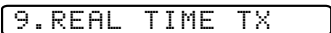

The number of pages you can scan into memory varies with the data they contain.

Real Time Transmission

When you are sending a fax, the MFC will scan originals into memory before sending. Then, as soon as the phone line is free, the MFC will start dialing and sending the fax. If memory becomes full, the MFC will send the document in real time, even if REAL TIME TX is set to OFF.

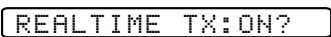
Sometimes you may want to send an important document immediately, without waiting for memory transmission. You can set REAL TIME TX to ON.



- 1 Place the original face down in the ADF.
- 2 Press **Function, 1, 3, 9**.

- 3 To change the default setting, press  or  to select ON (or OFF) and press **Set**.
Go to Step 5—**OR**—For the next fax transmission only, press  or  to select NEXT FAX ONLY and press **Set**.

- 4 For the next fax only, press  or  to select ON (or OFF) and press **Set**.
- 5 Press **1** if you want to select additional settings. The display returns to the SETUP SEND menu—**OR**—Press **2** if you are finished choosing settings and go to Step 6.
- 6 Enter fax number and press **Start**.



A color fax will be sent even if REALTIME TX is set to OFF.



Checking the Job Status

Check which jobs are still waiting in memory to be sent. (If no jobs are waiting, the screen displays NO JOB WAITING.) (See *Canceling a Job in Memory* below.)

- 1 Press **Function, 1, 4**.
- 2 If you have multiple jobs waiting, press  or  to scroll through the list.
- 3 Press **Stop** to exit.

Canceling a Job in Memory

You can cancel tasks you've scheduled, such as Polling Transmit, as well as all faxes waiting in Memory to be sent. (See *Checking Job Status* above.)

- 1 Press **Function, 1, 4**. Any waiting jobs appear on the display. If no jobs are waiting, the screen displays NO JOB WAITING. 
- 2 If you have more than two jobs waiting, press  or  to select the job you want to cancel and press **Set**.
—OR—
If you have only one job waiting, go to step 3.
- 3 Press **1** to cancel—OR—Press **2** to exit without canceling. To cancel another job, return to Step 2.
- 4 Press **Stop** to exit.

Basic Sending Operations

Composing Electronic Cover Page

The cover page is generated at the receiving party's machine. Your cover page includes the name stored in the One Touch or Speed Dial memory. If you're dialing manually, the name is left blank. (See *One Touch* and *Speed Dialing*, page 8-5.)

The cover page indicates your Station ID, and the number of pages you're sending. If you have Cover page Setup set to ON, the number of pages remains blank. (**Function, 1, 3, 1.**) (See *Setting Station ID*, page 5-1.)

You can select a comment to include on your cover page.

- 1. COMMENT OFF
- 2. PLEASE CALL
- 3. URGENT
- 4. COFIDENTIAL



Instead of using one of the comments above, you can enter up to two customized messages, each 27 characters long. Use the chart on page 5-2 to help enter characters. (See *Composing Your Own Comments* below.)

- 5. <USER DEFIND>
- 6. <USER DEFIND>

Most of the SETUP SEND functions are temporary settings that allow you to make adjustments for each document you send. However, so you can set up your cover page and cover page comments in advance, the Cover Page Setup and Cover Page Message functions will change the default settings.

Composing Your Own Comments





You can set up two custom comments.

- 1 Press **Function, 1, 3, 2.**
- 2 Press  or  to choose position 5 or 6 for your customized comment and press **Set.**
- 3 Use the dial pad to enter your customized comment and press **Set.** (See *Entering Text*, page 5-2.)
- 4 Press **1** if you want to select additional settings. The display returns to the SETUP SEND menu—**OR**—Press **2** to exit.

Cover Page For Next Fax Only

Make sure the Station ID is set up. (See page 5-1.) This feature does not work without the Station ID.





You can set the fax to send a cover page with a particular document. This cover page will include the number of pages in your document.

- 1 Place the original face down in the ADF.
- 2 Press **Function, 1, 3, 1**.
- 3 When the screen displays NEXT FAX ONLY?, press **Set**.
- 4 Press  or  to select ON (or OFF) and press **Set**.
- 5 Press  or  to select one of the standard or custom comments and press **Set**.
- 6 Enter two digits to indicate the number of pages you are sending, and press **Set**. (Enter **00** to leave the number of pages blank.) If you make a mistake, press  to back up and reenter the number of pages.
- 7 Press **1** if you want to select additional settings. The display returns to the SETUP SEND menu—**OR**—Press **2** if you are finished choosing settings, and go to Step 8.
- 8 Enter the fax number you're calling.
- 9 Press **Start**.

Always Send Cover Page



Make sure Station ID is set up (See page 5-1). This feature does not work without the Station ID.

You can set the MFC to send a cover page whenever you send a fax. The number of pages in your fax is not included when you use this setting.

- 1 Press **Function, 1, 3, 1**.
- 2 Press  or  to select COVERPAGE:ON? and press **Set**.
- 3 If you selected ON, press  or  to select one of the standard or custom comments and press **Set**.
- 4 Press **1** if you want to select additional settings. The display returns to the SETUP SEND menu—**OR**—Press **2** to exit if you are finished choosing settings.

Using a Printed Cover Page

If you prefer using a printed cover page that you can write on, you can print the sample page and attach it to your fax.



- 1 Press **Function, 1, 3, 1**.
- 2 Press  or  to select PRINT SAMPLE? and press **Set**.
- 3 Press **Start**. Your MFC prints a copy of your cover page.

=== COVER PAGE ===	
TO:	_____
FROM:	_____
FAX:	
TEL:	
	PAGE(S) TO FOLLOW
COMMENT:	

Advanced Sending Operations

Overseas Mode

After you send a fax using this feature, the feature turns itself off.

- 1 Place the original face down in the ADF.
- 2 Press **Function, 1, 3, 5**. 
- 3 Press  or  to select ON (or OFF) and press **Set**.
- 4 Press **1** if you want to select additional settings. The display returns to the SETUP SEND menu—**OR**—Press **2** if you are finished choosing settings and go to Step 5.
- 5 Enter the fax number you're calling.
- 6 Press **Start**.

Call Reservation



You can send a fax and let the other party know that you want to speak to him after the fax transmission is complete. The other fax machine will ring as if it were receiving a telephone call; if the other party picks up the handset, your MFC will ring. Lift the handset to have a conversation. You must register your Station ID to set Call Back Message to ON.

If you set Call Reservation and Call Back message to ON, your MFC leaves a message if the other party does not answer.

1 Place the original face down in the ADF.



2 Press **Function, 1, 3, 6.**

CALL RESERVE:OFF

3 Press  or  to select CALL RESERVE:ON? (or OFF) and press **Set.**

The screen displays the current setting for Call Back Message.

CALL BACK:OFF?

4 Press  or  to select ON (or OFF) and press **Set.**

CALL BACK:ON?

5 Press **1** if you want to select additional settings. The display returns to the SETUP SEND menu—**OR**—Press **2** if you are finished choosing settings, and go to Step 6.

6 Enter the fax number.

7 Press **Start.**

8 If you've set Call Reservation to ON, pick up your handset if the MFC rings.

 You cannot use automatic redial with Call Reservation. You cannot use Call Reservation with Delayed Transmission or with Polling.

Print Sample Call Back Message



1 Press **Function, 1, 3, 6.**

2 Press  or  to select PRINT SAMPLE? and press **Set.**

3 Press **Start.**

Delayed FAX (Not Available for Color Fax)

During the day you can store *up to* 50 documents in memory for delayed sending. Transmission of these documents will begin at the time of day you enter in Step 3. Step 3 will display the time you entered last. Press **Set** to accept it, or enter another time for this fax.



- 1 Place the original face down in the ADF.
- 2 Press **Function, 1, 3, 7.**
- 3 Enter the time you want the fax to be sent, in 24-hour format and press **Set.** (For example, enter 19:45 for 7:45 PM.)
- 4 Press **1** to leave the originals waiting in the ADF—**OR**—Press **2** to scan the document into memory. 
- 5 Press **1** if you want to select additional settings. The display returns to the SETUP SEND menu—**OR**—Press **2** if you are finished choosing settings and go to Step 6. 
- 6 Enter the fax number.
- 7 Press **Start.** The MFC will wait to send the fax at the time you set up.



The number of documents you can scan into memory varies with the data they contain.

Delayed Batch Transmission (Not Available for Color Fax)



Before sending the delayed faxes, your Brother machine will economize by sorting all the documents in memory by destination and scheduled time. All delayed faxes scheduled at the same time to the same fax number will be sent as one transmission.

- 1 Press **Function, 1, 3, 0.**
- 2 Press  or  to select ON (or OFF) and press **Set.**
- 3 Press **Stop** to exit.



Multiple Resolution Transmission (Not Available for Color Fax)

Use this feature to select separate resolution settings for each page of the fax you're sending. This could be useful if you're sending a fax with photos and letters, or some pages with small print and others with normal print. Resolution settings return to STANDARD after the fax is sent.

- 1 Place the original face down in the ADF.
- 2 Press **Function, 1, 3, 4.**
- 3 Press  or  to select resolution for page 1, then press **Set.**
- 4 Repeat Step 3 for subsequent pages.
- 5 Press **Stop** when you're finished.
- 6 Press **1** if you want to select additional settings. The display returns to the SETUP SEND menu—**OR**—Press **2** if you are finished choosing settings, and go to Step 7.
- 7 Enter the fax number you're calling.
- 8 Press **Start.**

STANDARD—For most typed documents.



FINE—Good for small print; transmits slower than standard resolution.

S.FINE—Good for small print or art work; transmits slower than fine resolution.

PHOTO—Use when document has varying shades of gray; slowest transmission time.

Setting Up Polled Transmit (Not Available for Color Fax)

Polled Transmit is when you set up your MFC to wait with a document so another fax machine can retrieve it.

- 1 Place the original to be retrieved face down in the ADF.
- 2 Press **Function, 1, 3, 8.**
- 3 Press  or  to choose POLLED TX:ON? and press **Set.**
- 4 Press **1** to select DOC if you want your MFC to scan the printed document at the time it is polled—**OR**—Press **2** to select MEMORY.
- 5 Press **1** if you want to select additional settings. The display returns to the SETUP SEND menu—**OR**—Press **2** if you are finished choosing settings and go to step 6.

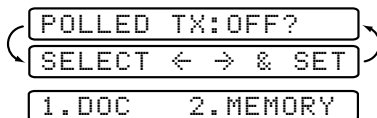

6 Press **Start**.



If you pressed **1** in Step 4, the printed document remains in the ADF until your MFC is polled. If you must use your MFC before the polled transmit occurs, you must cancel this job.

8

Auto Dial Numbers and Dialing Options

Storing Numbers for Easy Dialing

You can set up your MFC to do three types of easy dialing: One Touch, Speed Dial and Groups for Broadcasting faxes.



*If you loose electrical power, auto dial numbers in memory will **not** be lost.*

Storing One Touch Dial Numbers

You can store 8 fax/phone numbers that you can dial by pressing one key (and **Start**). You also can store names with these numbers. When you press a One Touch dial location, the screen displays the name or number as the call is dialed. (See *One Touch Dialing*, page 8-5.)

One Touch keys are not the dial pad keys. They are the 4 keys (numbers 1–4) located underneath the dial pad.

Numbers 5-8 are accessed by holding down shift while you press the appropriate One Touch key.

- 1 Press **Function, 1, 5, 1**.
- 2 Press the One Touch key where you want to store a number. To store a number in locations 5–8, press **Shift**, then press a key. (One-Touch key **1** is pre-programmed for Brother fax-back system, USA only. You can override it if you wish.) The screen displays the location you selected.
- 3 Enter a number (up to 20 digits) and press **Set**. If you want to enter a pause in the dialing sequence (for example, to wait for an “outside line”), press **Redial/Pause** as you’re entering digits. Pressing **Redial/Pause** enters a 3.5 second pause when the number is dialed, and a dash appears on the screen.
- 4 Use the dial pad to enter the name (up to 15 characters) and press **Set**. You can use the chart on page 5-2 to help you enter letters—**OR**—To store the number without a name, press **Set**.
- 5 Press **◀** or **▶** to select the type of number and press **Set**.

NAME:

- FAX** a fax only number
TEL a telephone (voice) number
FAX/TEL both a fax and telephone (voice) number



- 6 Return to Step 2 to store another One Touch number—**OR**—Press **Stop** to exit. When you dial an AUTO DIAL number, the screen displays the name you've stored, or, if you haven't stored a name, the number you've stored.



If you need to store a pause longer than 3.5 seconds, press **Redial/Pause** two or more times.

Storing Speed Dial Numbers

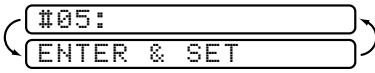
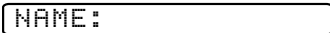
You can store Speed Dial numbers, so when you dial you only have to press four keys. The MFC has 100 Speed Dial locations.



- 1 Press **Function, 1, 5, 2**.

- 2 Use the dial pad to enter a two-digit location (00-99) and press **Set**.

- 3 Enter the number (up to 20 digits) and press **Set**.
- 4 Use the dial pad to enter the name (up to 15 characters) and press **Set**. You can use the chart on page 5-2 to help you enter letters—**OR**—Press **Set** and go to Step 6 to store the number without a name.

- 5 The screen prompts you to select the type of number this is. Press  or  to select the type of number and press **Set**.

FAX	A fax number
TEL	A telephone (voice) number
FAX/TEL	Both a fax and telephone number
- 6 Return to Step 2 to store another Speed Dial number—**OR**—Press **Stop** to exit.

Changing One Touch and Speed Dial Numbers

If you try to store a One Touch or Speed Dial number in a location where a number is already stored, the screen displays the current name stored there, then prompts you to either

1. CHANGE—OR—2. EXIT.

- 1** Press **1** to change the number stored, or press **2** to exit without making a change.
- 2** Enter a new number and press **Set**.
 - If you want to erase the whole number, press **Stop** when the cursor is to the left of the digits. The letters above and to the right of the cursor will be deleted.
 - If you want to change a digit, use  or  to position the cursor under the digit you want to change, then type over it.
- 3** Follow the directions beginning at Step 4 in *Storing One Touch Numbers* and *Storing Speed Dial Numbers*.

Setting Up Groups for Broadcasting

Groups allow you to send the same fax message to many fax numbers by pressing only one One Touch Group key (and **Start**). **First**, you'll need to store each fax number as a One Touch or Speed Dial number. **Then**, you can combine them into a Group. Each Group uses up a One Touch key. Finally, you can have up to six small Groups, or you can assign up to 107 numbers to one large Group. (See *Storing One Touch Dial Numbers*, page 8-1 and *Storing Speed Dial Numbers*, page 8-2 and *Broadcasting*, page 8-7.)

- 1 Press **Function**, **1**, **5**, **3**.

SELECT ONE-TOUCH

- 2 Select a One Touch key where you wish to store the Group number. (For example, press One Touch key **2**.)

SETUP GROUP:GO
ENTER & SET

- 3 Use the dial pad to enter the Group number and press **Set**. (For example, press **1** for Group 1).

- 4 To include One Touch or Speed Dial numbers in the Group, enter them as if you were dialing. For example, for One

G01:*05#09_

Touch number 5, press One Touch key **5**. For Speed Dial location 09, press the **Search/Speed Dial** button, then press **0**, **9** on the dial pad. The LCD shows ✖51, #09.

- 5 Press **Set**. to accept the numbers for this group.

NAME:
ENTER & SET

- 6 Use the dial pad and the chart on page 5-2 to enter a name for the group and press **Set**. (For example, NEW CLIENTS).

- 7 Press **Stop** to exit.



You can print a list of all One Touch and Speed Dial numbers. (See Chapter 10, *Printing Reports*.)

Dialing Options

You can use your MFC to make voice telephone calls, by dialing manually, or by using Search, One Touch or Speed Dial memory. When you dial an auto dial number, the screen displays the name you've stored, or, if you haven't stored a name, the fax number you've stored.

One Touch Dialing

- 1 Pick up the handset.
- 2 When you hear a dial tone, press the One Touch key of the location you will want to call. (See *Storing One Touch Dial Numbers*, page 8-1.)
- 3 To hang up, replace the handset.



If you try to use a One Touch location with no number stored in it, you will hear a warning sound, and the LCD will display NOT REGISTERED for 2 seconds.



If you are sending a fax, press **Start** after pressing the One Touch key. If you picked up the handset, press **Start** when the receiving fax machine answers with fax tones.

Speed Dialing

- 1 Pick up the handset.
- 2 When you hear a dial tone, press **Search/Speed Dial**, press **#**, then press the two-digit Speed Dial location. (See *Storing Speed Dial Numbers*, page 8-2.)
- 3 To hang up, replace the handset.



If you are sending a fax, press **Start** after entering the Speed Dial number. If you picked up the handset, press **Start** when the receiving fax machine answers with fax tones.

Access Codes and Credit Card Numbers

Sometimes you may want to choose from among several long distance carriers when you make a call. Rates may vary depending upon the time and destination. To take advantage of low rates, you can store the access codes or long-distance carriers as One Touch numbers. You can store these long dialing sequences by dividing them and setting them up on separate keys in any combination. You can even include manual dialing using the dial pad. The combined number will be dialed in the order you entered it, as soon as you press **Start**. (See *Storing One Touch Dial Numbers*, page 8-1.)



You can store “555” on One Touch key **3** and “7000” on One Touch key **2**. If you press One Touch **3**, **2**, and **Start**, you can dial “555-7000”. To temporarily change a number, you can substitute part of the number with manual dialing using the dial pad. For example, to change the number to 555-7001 you could press One Touch **3** and press **7, 0, 0, 1** using the dialing pad.



If you must wait for another dial tone at any point in the dialing sequence, store a pause at that point in the number by pressing **Redial/Pause**. Each key press adds a 3.5 second delay.

Search

You can search for names you have stored in One Touch and Speed Dial memories. Names are stored alphabetically. (See *Storing One Touch Dial Numbers*, page 8-1 and *Storing Speed Dial Numbers*, page 8-2.)

- 1 Press **Search/Speed Dial**, then enter the first letter of the name you’re looking for.
- 2 Press  or  to search the memory.
- 3 When the screen displays the name you want to call, pick up the handset.
- 4 Press **Start** to begin dialing.
- 5 When the call is over, hang up.

Broadcasting (Not Available for Color Fax)

Broadcasting is automatically sending the same fax message to multiple fax numbers. Using the **Set** key, you can include Groups, One Touch locations, Speed Dial locations and up to 50 manually dialed numbers. If you did not use up any locations for Groups, access codes or credit card numbers, you can "broadcast" faxes automatically to up to 158 different locations from the MFC. However, available memory will vary with all types of jobs in memory and numbers of locations used for broadcasting. If you broadcast to more than the maximum locations available, you will not be able to set up transmissions using dual access and the timer.

Although the easiest way to broadcast is to press Group keys, you can include One Touch, Speed Dial, and manually dialed numbers in the same broadcast. You must press **Set** between each of these locations. Use the Search to help you choose the numbers easily. (See *Setting Up Groups for Broadcasting*, page 8-4.)

This feature is NOT available for faxing images in color.

After the broadcast is completed, a Broadcast Report will be printed automatically to let you know the results.

- To stop the broadcasting in progress, press **Stop**. The LCD display asks if you want to cancel all locations or only the location that is being sent.
- Enter the long dialing sequence numbers as you normally would, but keep in mind that each key counts as one location, so the number of locations you can call becomes limited.
- If the line is busy or for some other reasons a connection could not be made while broadcasting, the MFC will redial the number automatically.
- If the memory is full, press **Stop** to abort the job or press **Start** to send the portion that is in the memory (if more than one page has been scanned.)

- 1 Place the original face down in the ADF.
- 2 Enter a number using One Touch, Speed Dial, Group number or Search.
Example: Group number
- 3 Press **Set**. You will be prompted to press the next number.
- 4 Enter the next number.
Example: Speed Dial
- 5 Press **Set**.
- 6 Enter the fax number.
Example: Manual dialing, using the dial pad.
- 7 Press **Start**.
Your MFC will read the original into memory and then start sending faxes to the numbers you entered.

Pause

Press **Redial/Pause** to insert a 3.5 second pause between numbers. If you are dialing overseas, you can press **Redial/Pause** as many times as needed to increase the length of the pause.

Hold

- 1 Press **Hold** to put a call on Hold.
- 2 You can replace the handset without disconnecting the call.
- 3 Pick up the MFC handset. (Picking up an extension handset will not release the call from Hold.)

Redial

If the last number you dialed was busy, press **Redial/Pause** for easy dialing.

Tone/Pulse (For Canada only)

If you have pulse dialing service, but need to send tone signals (for telephone banking, for example), follow the directions below. If you have touch tone service, you do not need this feature to send tone signals.

- 1 Lift the handset.
- 2 Press **#**. Any digits dialed after this send tone signals.
- 3 When you hang up, the MFC returns to pulse dialing service.

9

Remote Fax Options

(Not Available for Color Fax)

Fax Forwarding/Paging



You cannot use Paging and Fax Forwarding at the same time.
You cannot use Paging and Fax Forwarding when Fax Storage is set to OFF.

Programming a Fax Forwarding Number

When Fax Forwarding is set to ON, your MFC stores the received fax in memory, then dials the fax number you've programmed, and forwards the fax message.

- 1 Press **Function, 1, 7, 1**.
- 2 Press or until the screen displays FAX FORWARD? and press **Set**.
- 3 The screen prompts you to enter the number of the fax machine where faxes will be forwarded. Enter the forwarding number (up to 20 digits) and press **Set**.
- 4 Press **Stop** to exit.

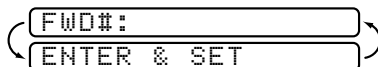

Programming Paging Number

When Paging is selected, your MFC dials the pager number you've programmed, and dials your Personal Identification Number (PIN) when connected, to activate your pager and let you know you have a fax message in the memory.

- 1 Press **Function, 1, 7, 1**.
- 2 Press or until the screen displays PAGING? and press **Set**.
- 3 Enter your pager phone number (up to 20 digits) followed by ## and press **Set**. Do not include the area code if it is the same as that of your MFC.
For example, 1 8 0 0 5 5 1 2 3 4 # #.
- 4 If your pager requires a PIN, enter the PIN, press #, press **Redial/Pause**, enter your MFC telephone number, press ##, then press **Set**.
For example, 1 2 3 4 5 # Redial/Pause 1 8 0 0 5 2 1 2 8 4 6 # #
—OR—
If you do not need a PIN, press **Redial/Pause**, enter the fax number of your MFC, then press ## and press **Set**.
For example, **Redial/Pause 1 8 0 0 5 2 1 2 8 4 6 # #**

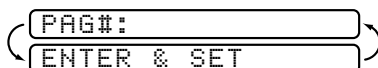
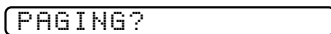

- 5 Press **Stop** to exit.



You cannot change a Paging number or PIN remotely.

Setting Fax Storage

If you set Fax Storage to ON, you will be able to retrieve fax messages from another location, using Fax Forwarding, Paging, or Remote Retrieval functions. The screen will indicate when you have a fax stored in memory.

- 1 Press **Function, 1, 7, 2**. The screen prompts you to choose a fax setting.
- 2 Press or to select ON (or OFF) and press **Set**.
- 3 Press **Stop** to exit.



If there are faxes in memory when you turn the Fax Storage OFF, the screens prompt you to erase any faxes in memory.

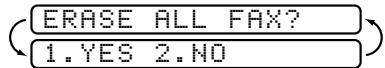

If you press **1**, all fax data is erased and Fax Storage is turned off. If you press **2**, data is not erased, and Fax Storage remains on. (See *Printing a Fax in Memory*, page 6-6.)

Changing Remote Retrieval Access Code

Enter your Remote Access Code when the MFC picks up your call, so you can access features remotely. The access code is preset to 1 5 9 *, but you can change this. (See *Operation from Extension Telephone*, page 6-5.)

- 1 Press **Function, 1, 7, 3**.
- 2 Enter a three-digit number from 000 to 999 and press **Set**. The “*” cannot be changed. (Do not use the same digits that appear in your Fax Receive Code or Telephone Answer Code.)
- 3 Press **Stop** to exit.

Remote Retrieval

You can call your MFC from any fax machine using touch tone, then use the Remote Retrieval Access Code and other button presses to retrieve fax messages. Cut out the Remote Retrieval Access Card on the last page and keep it in your wallet as an aid.

Using Remote Retrieval Access Code

- 1 Dial your MFC phone number from a fax machine using touch tone.
- 2 When your MFC answers, immediately enter your Remote Retrieval Access Code (1 5 9 ✳).
- 3 The MFC signals the kinds of messages received:
 - 1 long beep — Fax message(s)**
 - No long beeps — No messages**
- 4 The MFC then prompts you with two short beeps to enter a command. If you wait longer than 30 seconds to enter a command, the MFC hangs up. If you enter an invalid command, the MFC beeps three times.
- 5 Press **9 0** to reset the MFC when you're finished.
- 6 Hang up.



If your MFC is set to Manual mode, you can access it by waiting about 2 minutes, then entering the Remote Retrieval Access Code within 30 seconds.

Remote Commands

Follow the commands below to access features remotely. When you call the MFC and enter your Remote Retrieval Access Code (1 5 9 ✖), the system will signal you with two short beeps to enter a remote command.

Remote Commands		Operation Details
95	Changing Fax Forwarding /Paging setting	
	1 OFF	If you hear one long beep, the change is accepted. If you hear three short beeps, you cannot change it because the conditions have not been met (Example: registering paging number). You can register your fax forwarding number by using 4. FAX FWD NO. (see page 9-6). Once you have registered the number, the MFC will change automatically to FAXFWD:ON mode. Then retrieve a Memory Status List by entering 961 (see page 9-5) to make sure that the Fax Forwarding number you registered is correct in the List.
	2 Fax Forwarding	
	3 Paging	
	4 FAX FWD No.	
	6 Fax Storage ON	You can turn FAX STORAGE to ON or OFF.
7 Fax Storage OFF		
96	Retrieve a fax	
	1 Memory Status List	Enter the number of a remote fax machine to receive the Memory Status List or stored fax message(s). (See page 9-5.)
	2 Retrieve all faxes	
3 Erase fax from the memory	If you hear one long beep, you can erase fax message(s) from the memory.	
97	Check the Receiving Status	
	1 FAX	You can check whether your MFC has received any faxes. If yes, you will hear one long beep. If no, you will hear three short beeps.
98	Change Receive Mode	
	1 TAD	If you hear one long beep, you can change the Receive Mode. If you hear three short beeps, you cannot change it.
	2 FAX/TEL	
	3 FAX	
90	Exit	After a long beep, you can exit remote retrieval.

Retrieving Memory Status List

You can retrieve the Memory Status List from a remote fax machine to see if you have any fax messages.

- 1 Dial your fax number.
- 2 When you hear the beep, immediately enter your Remote Retrieval Access Code (1 5 9 ✖).
- 3 When you hear two short beeps, use the dial pad to press **9 6 1**.
- 4 Using the dial pad, enter the number of the remote fax machine where you want the Memory Status List forwarded (up to 20 digits), and then press **# #**.



You cannot use ✖ and # as dial numbers. However, if you want to store a pause, press #.

- 5 After you hear your MFC beep, hang up and wait.
Your MFC calls the remote fax machine. The remote fax machine prints the Memory Status List.

Retrieving Fax Messages

- 1 Dial your fax number.
- 2 When you hear the beep, immediately enter your Remote Retrieval Access Code (1 5 9 ✖).
- 3 As soon as you hear two short beeps, use the dial pad to press **9 6 2**.
- 4 Using the dial pad, enter the number of the remote fax machine where you want your fax messages forwarded (up to 20 digits), and then press **# #**.



You cannot use ✖ and # as dial numbers. However, if you want to store a pause, press #.

- 5 After you hear your MFC beep, hang up and wait.
Your MFC calls the remote fax machine. The remote fax machine prints your fax messages.

Changing Fax Forwarding Number

You can change the default setting of your fax forwarding number from a remote fax machine.

- 1 Dial your fax number.
- 2 When you hear the beep, immediately enter your Remote Retrieval Access Code (**1 5 9 ***).
- 3 When you hear two short beeps, use the dial pad to press **9 5 4**.
- 4 Enter the new number of the remote fax machine where you want your fax messages forwarded (up to 20 digits), then press **# #**.



You cannot use ***** and **#** as dial numbers. However, if you want to store a pause, press **#**.

- 5 To retrieve the Memory Status List, when you hear two short beeps, use the dial pad to press **9 6 1**.
- 6 Use the dial pad to enter the number of the remote fax machine (up to 20 digits), and then press **# #**.
- 7 After you hear your MFC beep, hang up and wait.
Your MFC calls the remote fax machine. The remote fax machine prints the Memory Status List showing the new forwarding number.
- 8 Check the forwarding number.
If the forwarding number is incorrect, return to Step 1 to reset it.

10 Printing Reports

MFC Settings and Activity

You can print the following lists and reports:

1. XMIT REPORT

Choose if you would like a Transmission Verification Report printed after all faxes you send.

2. ACT. REPORT

Activity Report lists information about the last 50 incoming and outgoing faxes. TX means Transmit; RX means Receive.

3. AUTO DIAL

Lists names and numbers stored in One Touch and Speed Dial memory, in numerical order.

4. TEL. INDEX

AUTO DIAL LIST (above), alphabetically.

5. HELP

Help list for quick reference.

6. USER SETTINGS

Lists settings for INITIAL SETUP, SETUP RECEIVE, SETUP SEND, PRINT REPORTS, and TEL SERVICE. The settings for REMOTE FAX OPT are included.

7. MEMORY STATUS

Lists summary information and amount of occupied memory.

8. ORDER FORM

Prints an accessories order form for the ordering accessories directly from Brother.

To Print a Report

- 1 Press **Function**, **1**, **6**. (See *Printing Reports*, page 10-1.)
- 2 Enter the number of the report you want to print. For example, press **4** to print the Telephone Index List.



For the Activity Report, also press or to select PRINT REPORT? and press **Set**.

- 3 Press **Start**.
- 4 Press **Stop** to exit.

Transmission Verification (Xmit) Report

You can use the Xmit Report as proof that you sent a fax. This report lists the name or fax number of the receiving party, the time and date of transmission, and if the transmission was successful.



When the feature is **OFF**, the report is printed *only* if there's an *error* during transmission. If the report indicates NG, send the fax again.



When the feature is **ON**, the report is printed with every fax you send.

If you typically send multiple faxes to the same destinations, you may need a reminder to identify each fax transmission. You can select **OFF+IMAGE** or **ON+IMAGE** to print a portion of the first page of the fax message on the report.

- 1 Press **Function, 1, 6, 1**.
- 2 Press or to select **OFF, OFF+IMAGE, ON** or **ON+IMAGE** and press **Set**.
- 3 Press **Stop** to exit.

Activity Report Interval

You can set the MFC to print activity reports at a specific interval (6, 12, 24 hours, 2, 4 or 7 days). If you set the interval to OFF, you can print the report by following the steps in the previous section.

- 1 Press **Function, 1, 6, 2**.
- 2 Press or to display: and press **Set**.
- 3 Press or to choose your setting and press **Set**.
(If you choose 7 days, the screen prompts you to choose the day at which to begin the 7-day countdown.)
- 4 Enter the time to begin printing in 24-hour format and press **Set**.
(For example, enter 19:45 for 7:45 PM).
- 5 Press **Stop** to exit.

11 Making Copies

Basic Copy Operations

Your Multi-Function Center allows you to make high-quality photocopies and transparencies. Copies can be in black and white, one color, or full color. Always make sure you have paper in the cassette before making copies. Do not pull on the paper while copying is in progress.

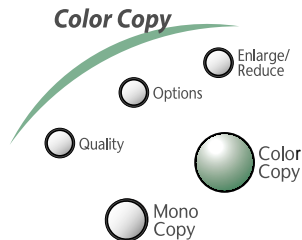

Making One Copy

- 1 Place the original face down in the ADF.
- 2 Press **Mono Copy** or **Color Copy**.
- 3 Press **Mono Copy** or **Color Copy** again. (Make sure it's the same key you pressed in Step 2.)

COPYING P.01



To stop the copy process and release the original, press **Stop**.

Making Multiple Copies

You can make multiple copies in black and white or one color using your MFC.

- 1 Place the original face down in the ADF.
- 2 Press **Mono Copy** or **Color Copy**.
- 3 Using the dial pad, enter the number of copies you want. For example, press **3, 8** for 38 copies.
- 4 Press **Mono Copy** or **Color Copy**.



You must press the same button you pressed in Step 2.



To sort copies, see *Using the Options Key*, page 11-4.



After you press **Mono Copy** or **Color Copy**, you can use the **Enlarge/Reduce**, **Quality** and **Options** keys to try different combinations of settings for best results.

Memory Full Message

If the memory becomes full while you are making copies, the screen displays a message:

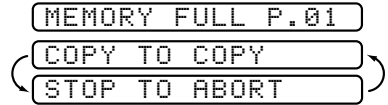

If the MEMORY FULL message appears while you are scanning the first page of your original, press **Stop** to cancel. You will need to clear some faxes from memory before you can continue. If you were scanning subsequent page(s), press **Mono Copy** or **Color Copy** to print the scanned pages—**OR**—Press **Stop** to cancel.



To gain extra memory, you can turn off Fax Storage (see page 9-2).
—**OR**—Print fax messages in memory (see page 6-6).

Temporary Copy Settings

You can improve your copies by using the Copy keys: **Enlarge/Reduce**, **Quality** and **Options**. These settings are *temporary*, and the MFC returns to its default settings when you finish copying. You can try different combinations of settings for best results.

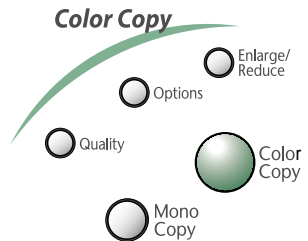

After you press **Mono Copy** or **Color Copy** you can use **Enlarge/Reduce**, **Quality** and **Options** to try different combinations of settings for best results.

Using Enlarge/Reduce Key

- 1 Place the original face down in the ADF.
- 2 Press **Enlarge/Reduce**.
- 3 Press **Left Arrow** or **Right Arrow** to choose an enlargement or reduction ratio and press **Set**.

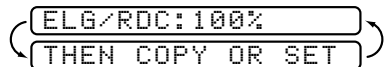

You can reduce to **93%**, **87%**, **75%**, **50%** or **25%** of the original size
—**OR**—

You can enlarge to **120%**, **125%**, **150%**, **200%** or **400%**
—**OR**—

For more choices select **ZOOM** and press **Set**. Use the dial pad to enter any percentage between **25%** and **400%**. For example, press **5, 3** to enter **53%**.

- 4 Press **Mono Copy** or **Color Copy**.
- 5 Using the dial pad, enter the number of copies and press **Set**.
—**OR**—
To accept the default (01), press **Set**.

When selecting a reduction ratio, you need to know the size of the paper you registered in Function 1-2-6.



If you want to make a copy the same size as the original document size, you should choose a reduction of 93%. (For example, if you want to copy from letter to letter, you should choose a reduction of 93%.)

If you are making a sort copy, see *Using the Options Key* on page 11-4.

Selecting the Ratios of Fixed Reduction:

Original Document the size of...	Paper size is...	Recommended reduction ratio is...
LETTER DOCUMENT	LETTER	93%
	LEGAL	100%
A4 DOCUMENT	LETTER	87%
LEGAL DOCUMENT	LETTER	75%
	LEGAL	93%

Using the Quality Key

The **Quality** key changes the settings for copy quality (NORMAL, HIGH, PHOTO, or DRAFT).

- DRAFT:** Fast copy speed and lowest ink consumption. Use DRAFT to save time (documents to be proof-read, large documents, or many copies).
- NORMAL:** Recommended mode for ordinary printouts. Good copy quality with adequate copy speed.
- HIGH:** Better copy quality than normal and faster copy speed than PHOTO.
- PHOTO:** Use this mode to copy precise images such as photographs. PHOTO uses the highest resolution and slowest speed.

1 Place the original face down in the ADF.

2 Press **Quality**.

3 Press or to select the copy quality resolution and press **Set**.

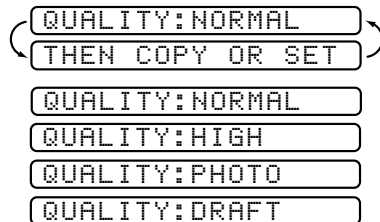

Using the Options Key

The **Options** key changes the settings for paper type, brightness and special copy options **for the next fax only**. These options will be displayed in the order of the chart below.

Press **Options**:

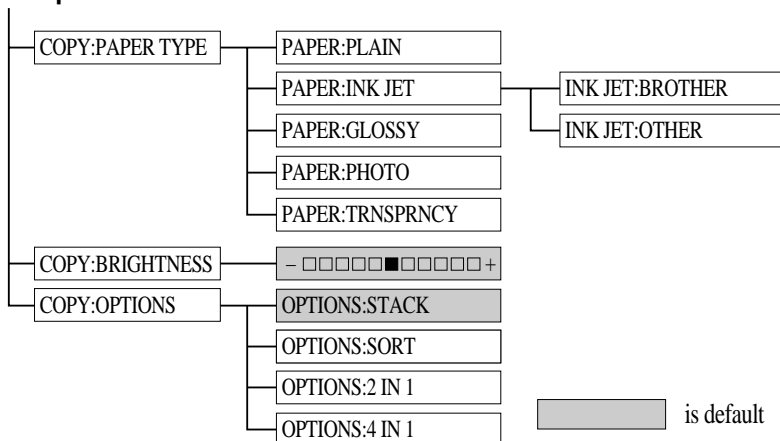

- 1 Place the original face down in the ADF.
- 2 Press **Options**.
- 3 Press **Left** or **Right** to select **COPY:PAPER TYPE**, **COPY:BRIGHTNESS**, or **COPY:OPTIONS**, and press **Set**.

*If you selected the **COPY:PAPER TYPE**:*



If you use premium paper, the copy quality will be improved. For best results, we recommend using Brother special paper.

- 4 Press **Left** or **Right** to select the type of paper you are using (**PLAIN**, **INKJET**, **GLOSSY**, **PHOTO** or **TRNSPRNCY**), and press **Set**.



Brother coated paper is ink jet paper.





If you are using non-Brother ink jet paper or Brother coated paper, select **INK JET**.

*If you selected **INK JET**:*

- 5 Press **Left** or **Right** to select **BROTHER** (BP72CL) or **OTHER** (non-Brother ink jet) paper type, and press **Set**.

*To select **COPY:BRIGHTNESS**:*

- 6 Repeat Step 3.

- 7 Press  to make a lighter copy—**OR**—press  to make a darker copy, and press **Set**.

To select special **COPY:OPTIONS**:

- 8 Repeat Step 3.
9 Press  or  to select **STACK, SORT, 2 IN 1** or **4 IN 1**, and press **Set**.

2in1

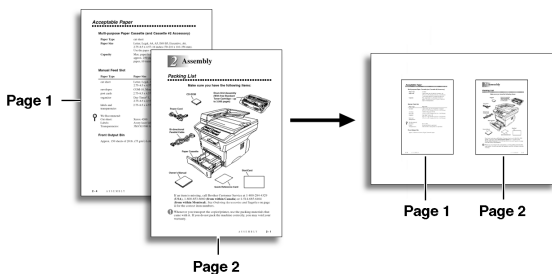

4in1

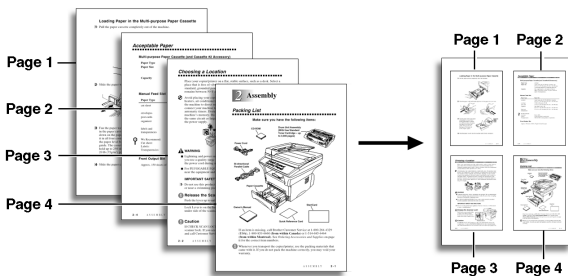

 **SORT, 2in1 or 4in1 prints in black and white only.**

- 10 Press **Mono Copy** or **Color Copy**.
11 Using the dial pad, enter the number of copies you want.
For example, press **3, 8** for 38 copies.
12 Press **Mono Copy** or **Color Copy**.

Changing Default Copy Settings

Press **Function, 3** to change default settings for Copy mode. These settings will remain until you change them again by pressing **Function**. Adjust the colors using the Color Adjustment, Brightness, and Contrast settings.

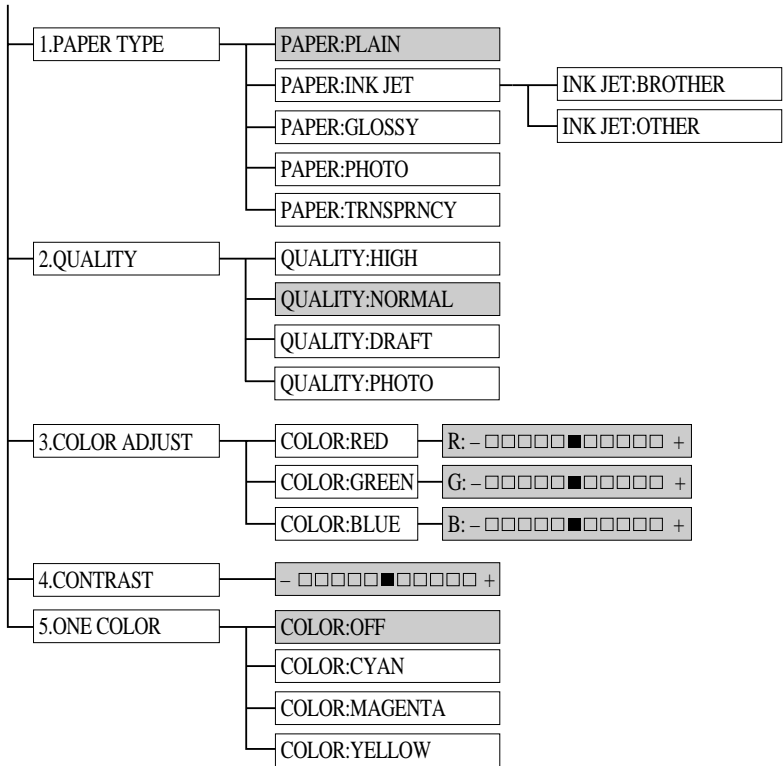

By pressing a number, you can adjust copy settings as shown in the following chart. Press **◀** or **▶** to scroll through the options for each setting. Press **Set** to save your selection. Press **Stop** to exit—**OR**—Press **▶** to select the next setting you want to change.

Press **Function**, and **3**.



 is default

Paper Type



- 1 Press **Function, 3, 1**.
- 2 Press  or  to select the type of paper setting and press **Set**.
 - If you use Brother coated paper, select **INK JET**, then select **BROTHER**.
 - If you use non-Brother ink jet paper, select **INK JET**, then select **OTHER**.
- 3 When the screen displays the type of **INK JET** paper, press **Set**. If you did not select **INK JET**, go to Step 4.
- 4 Press **Stop** to exit.

1.PAPER TYPE
PAPER:PLAIN
PAPER:INK JET
PAPER:GLOSSY
PAPER:PHOTO
PAPER:TRNSPRNCY







The MFC ejects paper with printed surfaces face up onto the paper tray in the front of the MFC. When you use transparencies, remove each sheet immediately, to prevent a paper jam or curled sheets.

Copy Quality

- 1 Press **Function, 3, 2**.
- 2 Press  or  to select the copy quality and press **Set**.
- 3 Press **Stop** to exit.

2.QUALITY
QUALITY:NORMAL
QUALITY:HIGH
QUALITY:PHOTO
QUALITY:DRAFT

Color Adjustment

- 1 Press **Function, 3, 3**.
- 2 Press  or  to select RED, GREEN, or BLUE and press **Set**.
- 3 Press  or  to adjust the degree of color and press **Set**.
- 4 Return to Step 2 to select the next color—**OR**—Press **Stop** to exit.

3.COLOR ADJUST
Light Dark
R:-□□□□■□□□□ +
G:-□□□□■□□□□ +
B:-□□□□■□□□□ +

Copy Contrast

You can change the contrast to help an image look sharper and more vivid.

- 1 Press **Function, 3, 4**.
- 2 Press ◀ to decrease contrast—**OR**—Press ▶ to increase contrast and press **Set**.
- 3 Press **Stop** to exit.

Single Color (One Color)

For black and white originals, you can select a single color, (instead of black) as the default to be used when you press **Mono Copy**. **OFF** is the setting for Black.

- 1 Press **Function, 3, 5**.
- 2 Press ◀ or ▶ to select a copy color and press **Set**.
- 3 Press **Stop** to exit.

5. ONE COLOR

COLOR: OFF

COLOR: CYAN

COLOR: MAGENTA

COLOR: YELLOW

Legal Limitations

Color reproductions of certain documents are illegal and may result in either criminal or civil liability. This memorandum is intended to be a guide rather than a complete listing of every possible prohibition. In case of doubt, we suggest that you check with counsel as to any particular questionable documents.

The following documents issued by the United States/Canadian Government or any of its Agencies may not be copied:

- Paper money
- Bonds or other certificates of indebtedness
- Certificates of Deposit
- Internal Revenue Stamps (canceled or uncanceled)
- Selective Service or draft papers
- Passports
- United States/Canadian Postage Stamps (canceled or uncanceled)
- Food Stamps
- Immigration Papers
- Checks or drafts drawn by Governmental agencies
- Identifying badges or insignias

Copyrighted works cannot be copied; however, sections of a copyrighted work can be copied for “fair use.” Multiple copies would indicate improper use.

Works of art should be considered the equivalent of copyrighted works.

Licenses and Certificates of Title to motor vehicles may not be copied under certain state/provincial laws.

12 Walk-Up Video Printing

Getting Started

Walk-Up Video Printing lets you use your MFC, connected to your camcorder, digital camera, video game, or VCR, to view a video on the attached equipment. The video signal and the output you create are NTSC (National Television System Committee). This is not compatible with any other standard.

With no documents in the feeder, plug the cable from your video camera's Video Out jack into the MFC's RCA pin jack. Play the video.

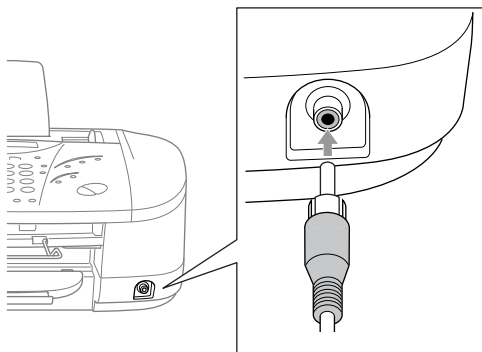

 Some camcorders, digital cameras, video games or VCRs do not correctly conform with NTSC standards. Then you would not be able to capture video signals.

Auto Switch

Whenever you connect video equipment to the MFC and turn the video signal on, the MFC's Copy keys automatically switch to video printing mode.

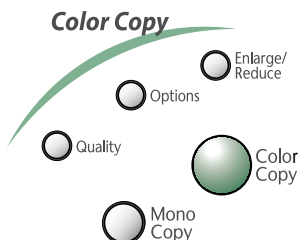

The LCD will display:



 As soon as you turn off the video equipment or disconnect it, the Copy Keys return to normal copy mode. You cannot access video printing mode if you have too much in memory.

Color Video Printing

- 1 With no original in the ADF, plug the cable from your video camera's Video Out jack into the MFC's RCA pin jack.
- 2 Play the video. When the MFC begins receiving the video signals, the MFC screen displays:

- 3 Press **Color Copy** when you see the picture you want to capture and print. The MFC begins printing, and beeps when printing is complete.



If the MFC is not receiving video signals, **Color Copy** will not work. However, if there is an original in the ADF, the MFC will print a color copy of the original.

Black & White Video Printing



For Black and white video printing, follow the steps for Color Video Printing, using **Mono Copy** instead of **Color Copy**.

Temporary Video Print Setting

You can quickly improve the copy quality of video printouts by using the Quality key and Options key. These settings are temporary, and the MFC returned to its default settings when you finish printing. You might want to try different combinations of settings to see which best suits you needs.

Using the Quality Key

Your MFC allows you to customize the quality of your video copies by letting you select the video print quality. You might want to try different combinations of settings to see which best suits your needs. The settings are temporary.

- 1 *Make sure the ADF is empty.* Plug the cable from your video camera's Out jack into the MFC's RCA pin jack.
- 2 Press **Quality**. The screen displays the current setting, for example:

- 3 Press  or  to select **QUALITY:NORMAL** or **QUALITY:HIGH** as the copy quality.



If there is too much in memory, the print quality will change.

- 4 When the screen displays your selection, press **Set**. The screen displays:

- 5 Using the dial pad, enter the number of copies you want (up to 99). For example,

press **3, 8** for 38 copies.

6 Press **Mono Copy** or **Color Copy**.

The LCD shows:

PRINTING

Using the Options Key

The **Options** key changes the settings for paper type, video type, print size, quality and brightness *for the next video printing only*. These options will be displayed in the order of the chart below.

Press **Options**.

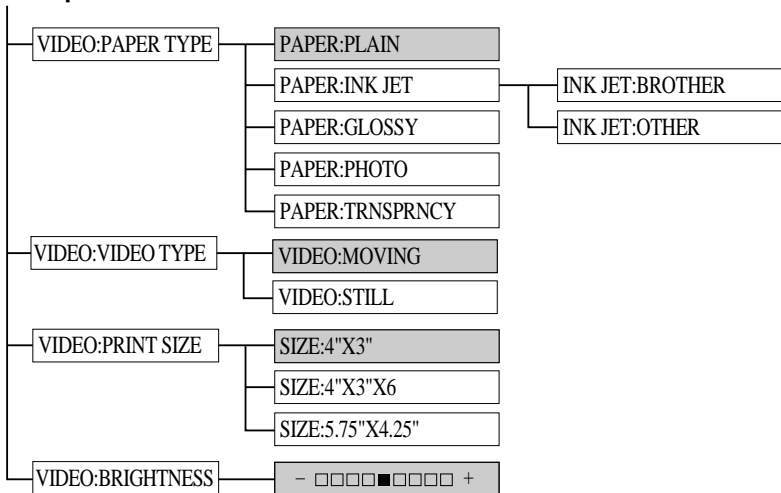

 is default

- 1** Make sure the ADF is empty. Plug the cable from your video camera's Out jack into the MFC's RCA pin jack.
- 2** Press **Options**.
- 3** Press **<** or **>** to select **VIDEO:PAPER TYPE**, **VIDEO:VIDEO TYPE**, **VIDEO:PRINT SIZE**, or **VIDEO:BRIGHTNESS** and press **Set**.

If you selected the **VIDEO:PAPER TYPE**:

 If you use premium paper, the copy quality will be improved. For best results, we recommend using Brother special paper.

- 4** Press **<** or **>** to select paper type you are using (**PLAIN**, **INK, JET**, **GLOSSY**, **PHOTO** or **TRNSPRNCY**), and press **Set**.

 Brother coated paper is ink jet paper.



If you are using non-Brother ink jet paper or Brother coated paper, select **INK JET**.

*If you selected **INK JET**:*

- 5 Press or to select **BROTHER** (BP72CL) or **OTHER** (non-Brother ink jet) paper type, and press **Set**.

*To select **VIDEO:VIDEO TYPE**:*

- 6 Repeat Steps 3.
- 7 Press or to select **MOVING** or **STILL**, and press **Set**.

*To select **VIDEO:PRINT SIZE**:*

- 8 Repeat Steps 3.
- 9 Press or to select **5.75"X4.25"**, **4"X3"** or **4"X3"X6**, and press **Set**.

*To select **VIDEO:BRIGHTNESS**:*

- 10 Repeat Steps 3.
- 11 Press to make a lighter copy—**OR**—press to make a darker copy, and press **Set**.
- 12 Press **Mono Copy** or **Color Copy**.
- 13 Using the dial pad, enter the number of copies you want (up to 99).
For example, press 3,8 for 38 copies.
- 14 Press **Mono Copy** or **Color Copy**.

Changing Default Settings

Press **Function** and **4** to change default settings for video printing.

By pressing **Function, 4** and a number, you can adjust video printing settings as shown in the following chart. Press **<** or **>** to move through the selection for each setting. Press **Set** to save your selection.

Press **Function** and **4**:

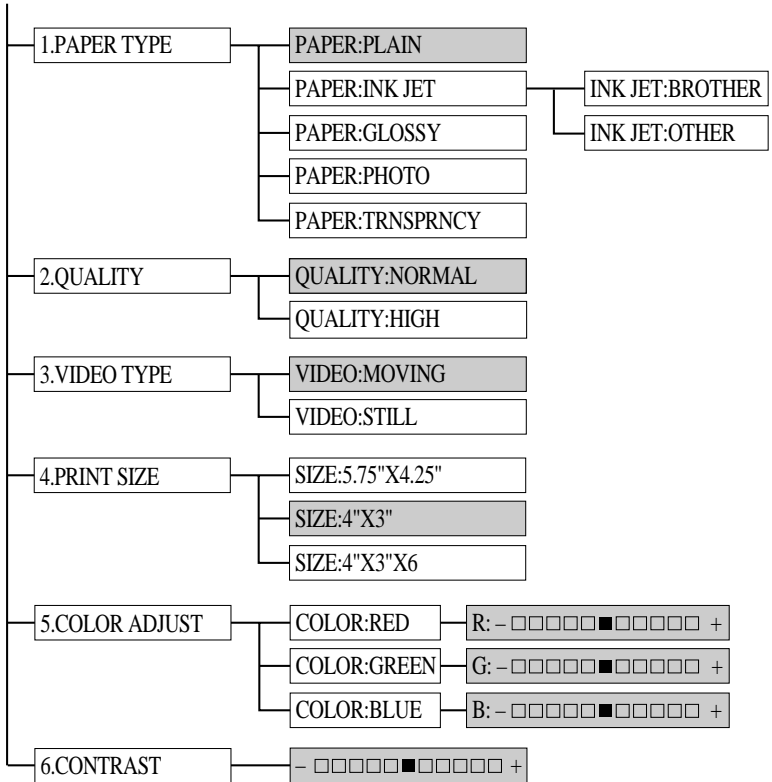

 is default

Paper Type

1 Press **Function, 4, 1.**

1.PAPER TYPE

2 Press ◀ or ▶ to select the paper type and press **Set.**

PAPER:PLAIN

- If you are using Brother coated paper , select **INK JET**, then select **BROTHER** (in Step 4).

PAPER:INK JET

PAPER:GLOSSY

- If you are using non-Brother ink jet paper, select **OTHER** (in Step 4).

PAPER:PHOTO

PAPER:TRNSPRNCY

3 When the screen displays the type of INK JET paper press **Set.** If you did not select INK JET, go to Step 4.

4 Press **Stop** to exit.

Video Printing Quality

1 Press **Function, 4, 2.**

2.QUALITY

2 Press ◀ or ▶ to select the quality and press **Set.**

QUALITY:NORMAL

3 Press **Stop** to exit.

QUALITY:HIGH

Video Type

Before you turn on the video signal, you must set the MFC to receive either a moving or a still image. You can watch the video play on the video camera and press **Mono Copy** or **Color Copy** when you see the frame you want to print.

1 Press **Function, 4, 3.**

3.VIDEO TYPE

2 Press ◀ or ▶ to select the video type and press **Set.**

VIDEO:MOVING



3 Press **Stop** to exit.

VIDEO:STILL



If you don't have enough memory to process the selected video image, the print quality may be poor even for a still frame.

Print Size

- 1 Press **Function, 4, 4**.
- 2 Press  or  to select print size and press **Set**.
- 3 Press **Stop** to exit.

4.PRINT SIZE

SIZE:4"X3"

SIZE:5.75"X4.25"

SIZE:4"X3"X6

Printed Position

① 5.75" x 4.25"

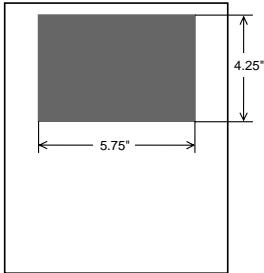



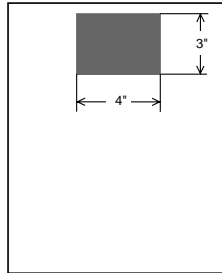

② 4" x 3"

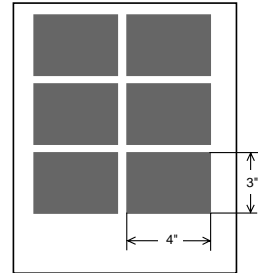

③ 4" x 3" x 6



Video Printing Color Adjustment

- 1 Press **Function, 4, 5**.
- 2 Press  or  to select **RED, GREEN, or BLUE** and press **Set**.
- 3 Press  or  to adjust the degree of color and press **Set**.
- 4 Return to Step 2 to select the next color —**OR**—Press **Stop** to exit.

5.COLOR ADJUST

Light

Dark

R:-□□□□□■□□□□□ +

G:-□□□□□■□□□□□ +

B:-□□□□□■□□□□□ +

Video Printing Contrast

You can change the Contrast to help an image look sharper and more vivid.

1 Press **Function, 4, 6.**

6. CONTRAST

2 Press  to decrease contrast.

—OR—

Press  to increase contrast.

3 Press **Set.**

-□□□□■□□□□+

4 Press **Stop** to exit.

Video Capture to PC

For complete instructions on using your MFC and computer for video frame capture, please see *Video Capture from the PC*, page 18-10 or the Multi-Function Link[®] Pro On-Line Documentation (on CD-ROM).

13 Walk-Up PhotoCapture Center™ (For MFC 7400C only)

General Description

Your Brother MFC includes two media drives for use with popular digital camera media: Compact Flash™ and SmartMedia™. The PhotoCapture Center™ feature of your MFC enables you to print digital photos from your digital camera at high resolution for photo quality printing. You can also print color video frames from VCR, camcorder or digital camera using standard NTSC video port connection.

This unique feature of your Brother MFC allows you to capture video frames to be stored on your PC, as well as to print, fax, save or integrate images into other files quickly and easily.

Getting Started

- 1 Insert the media card into the media drive (PhotoCapture Center™).



Please note that there are two slots on your MFC, one is for a Compact Flash™ card, and the other is for a SmartMedia™ card. Please note to use the media cards for 3.3 voltage only.



The top slot is for a Compact Flash™ Card, the bottom is for a SmartMedia™ Card. Insert the card by positioning the top of the card pointing to the left. Firmly insert the card into the appropriate slot.

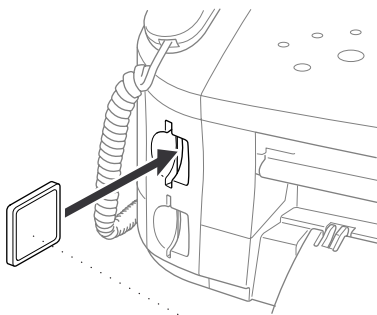

For Compact Flash™ Card

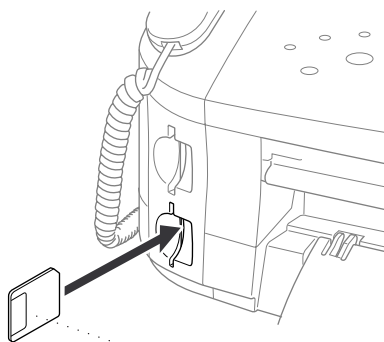

For SmartMedia™ Card

Media Card Indicator Lights:

- LED light is on when the media card is inserted properly.
- If LED is not on, the media card is not properly inserted.
- If LED is blinking, the media card is being read or written.



Do NOT remove the SmartMedia™ or CompactFlash™ card from the PhotoCapture Center™ while the MFC is reading the card (LED is flashing), you loose your data or damage the card.



WARNING

Do not remove the media card while the LED is blinking; it will damage the data stored on the card.



If both media cards are inserted at the same time, the PhotoCapture Center™ will only read the card that was installed first.



To have access to the other card, you must first remove both cards, then insert only the media card.

User settings are kept until the media card is removed.

DPOF Printing

DPOF stands for Digital Print Order Format. Major Digital Camera manufactures (Cannon Inc, Eastman Kodak Company, Fuji Photo Film Co., Ltd. and Matsushita Electric Industrial Co., Ltd.) created this standard to make it easier to print images from a digital camera.

If your digital camera supports DPOF printing, you will be able to select on the Digital Camera display the images and number of copies you wish to print. When the memory card (CompactFlash™ or SmartMedia™) with DPOF information is inserted into your Brother MFC, the images you selected will be printed automatically.

- 1 Insert your media card into the appropriate slot.
- 2 Press **Color Copy**. If there is a DPOF file on the card, the LCD will display **DPOF PRINTING**.

That's all you need to know to use this feature.

Printing Thumbnails

The LCD shows:

S MEDIA ACTIVE

PRESS COLOR COPY

- 1 Press **Color Copy** to to select whether you want to print a thumbnail page or the images from your media card.
- 2 Press **1** to print thumbnails.

1. INDEX 2. IMAGE

The PhotoCapture Center™ assigns numbers for the images (i.e. 001, 002, 003, etc...). It does not recognize any other numbers or file names that your digital camera or video camera or PC have used to identify the pictures.

Printing Images

The LCD shows:

S MEDIA ACTIVE
PRESS COLOR COPY

- 1 Press **Color Copy** to select whether you want to print a thumbnail page, or the images from your media card.

1. INDEX 2. IMAGE

- 2 Press **2** to select individual images.

IMG:

- 3 Enter the image number. You can select more than one image at the same time:

ENTER&PRESS SET

Press ***** for comma, (**1*3*6** - meaning image 1, 3 and 6),

Press **#** to print in sequence (**1#5** - meaning images 1 through 5).

You can press **Quality** to adjust the quality of your output.

QUALITY:NORMAL

THEN COPY OR SET

Press ◀ or ▶ to select the copy quality:

QUALITY:NORMAL

QUALITY:HIG

QUALITY:PHOTO

- 4 Press **Color Copy** to print the image:
—OR—

No. OF COPIES:01

ENTER & COPY KEY

Press **Options** to change the settings for paper type, print size and color enhancement:

PAPER TYPE

SELECT;← → & SET



Using the Option Key

The **Options** key changes the settings for paper type, print size and color enhancement for **the next fax only**. These options will be displayed in the order of the chart below.

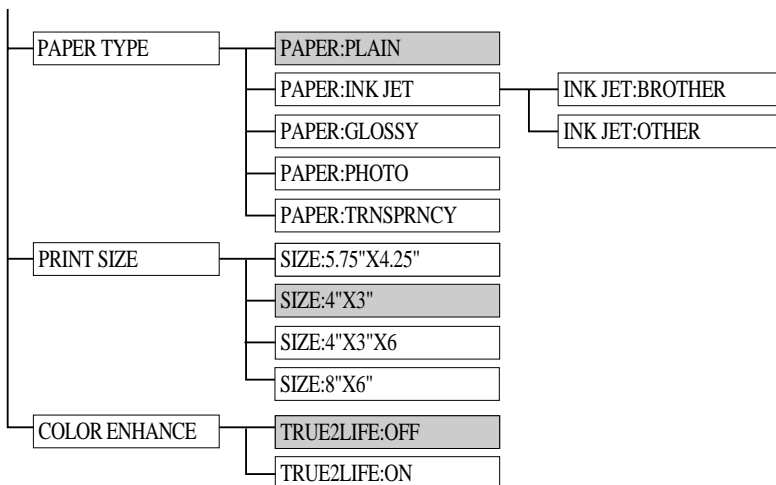
Press **Options**.



 is default

- 1 Press **Options**.
- 2 Press  or  to select **PAPER TYPE**, **PRINT SIZE** or **COLOR ENHANCE**, and press **Set**.

*If you selected the **PAPER TYPE**:*



If you use premium paper, the copy quality will be improved. For best results, we recommended using Brother specials paper.

- 3 Press  or  to select the type of paper you are using (**PLAIN**, **INK JET**, **GLOSSY**, **PHOTO** or **TRNSPRNCY**), and press **Set**.





Brother coated paper is ink jet paper.



If you are using non-Brother ink jet paper or Brother coated paper select **INK JET**.

*If you selected **INK JET**:*

- 4 Press Press  or  to select **BROTHER** (BP72CL) or **OTHER** (non-Brother ink jet) paper type, and press **Set**.

To select **PRINT SIZE**:

- 5 Repeat Step 3.
- 6 Press ◀ or ▶ to select **5.75"x 4.25"**, **4"x3"**, **4"x3"x 6"** or **8"x 6"** and press **Set**.

To select **COLOR ENHANCE**:

- 7 Repeat Steps 3.
- 8 Press ◀ or ▶ to select **TRUE 2 LIFE:ON** or **TRUE 2 LIFE:OFF**, and press **Set**.

The MFC allows you to customize the color enhance is set by using Function key if you select TRUE 2 LIFE ON. (See *Color Enhancement*, page 13-8.)

- 9 Press **Color Copy** to return to the screen:

NO.OF COPIES:01

Select the number of copies you wish to make and press **Color Copy**.



- The PhotoCapture Center™ only prints in color, no Black & White printing is available when using this feature.
- Enlargement or reduction is not available while using the PhotoCapture Center™.
- User settings are kept until media card is inserted. The PhotoCapture Center™ automatically goes back into its default setting after the media card is removed.

Changing Default Settings

By pressing **Function, 5** and a number, you can adjust the PhotoCapture Center™ settings as shown in the following chart. Press the arrow (◀ or ▶) keys to move through the options for each setting. Press **Set** to save your selection.

Press **Function, 5**:

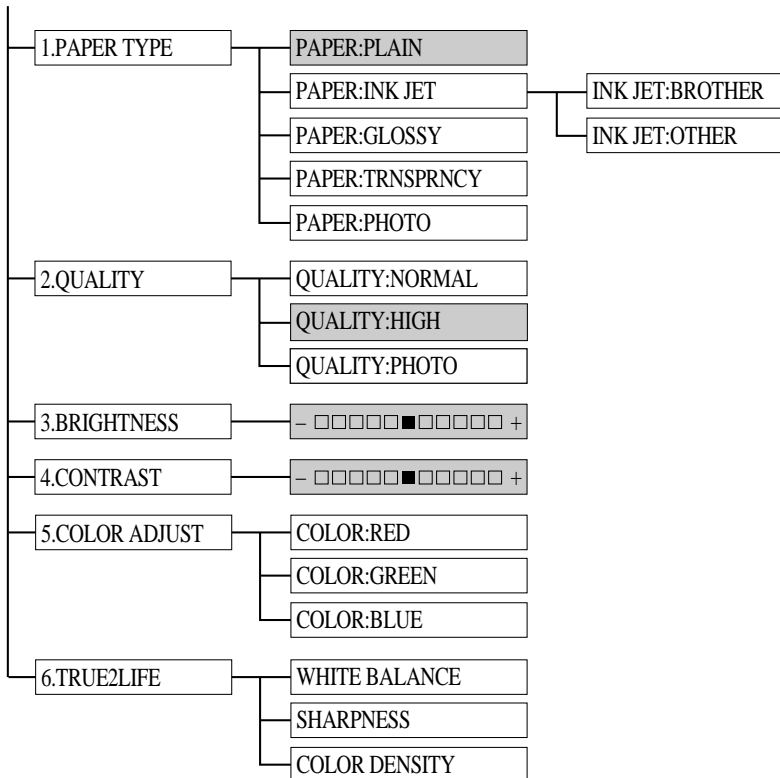

 is default.

Paper Type

- 1 Press **Function, 5, 1.**

The screen displays:

- 2 Press ◀ or ▶ to select a paper type, and press **Set.**

- If you are using Brother coated paper, select **INKJET**, then select **BROTHER** (in Step 4).
- If you are using non-Brother ink jet paper, select **OTHER.**

- 3 When the screen displays the type of **INK JET** paper, press **Set.** If you did not select **INK JET** go to Step 4.
- 4 Press **Stop** to exit.

1.PAPER TYPE

PAPER:PLAIN

PAPER:INK JET

PAPER:GLOSSY

PAPER:PHOTO

PAPER:TRNSPRNCY

Setting PhotoCapture Center™ Quality

- 1 Press **Function, 5, 2.** The screen displays **2. QUALITY.**

- 2 Press ◀ or ▶ to select a quality, and press **Set.**

- 3 Press **Stop** to exit.

2.QUALITY

QUALITY:HIGH

QUALITY:PHOTO

QUALITY:NORMAL

Photo Brightness

You can adjust the brightness setting before making a copy.

- 1 Press **Function, 5, 3.**

- 2 Press ◀ to make a darker copy and press **Set—OR—**
Press ▶ to make a lighter copy and press **Set.**

- 3 Press **Stop** to exit.

Photo Contrast





You can choose the contrast setting for a copy. Greater contrast can help an image look sharper and more vivid. This feature is available only for color copying.

- 1 Press **Function, 5, 4.**

- 2 Press ◀ to decrease contrast and press **Set—OR—**
Press ▶ to increase contrast and press **Set.**



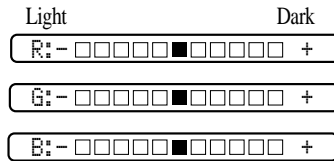

- 3 Press **Stop** to exit.

Color Adjustment

- 1 Press **Function, 5, 5**.
- 2 Press  or  to select **RED, GREEN** or **BLUE** and press **Set**.
- 3 Press  or  to adjust the degree of color and press **Set**.
- 4 Return to Step 2 to select the next color—**OR**—Press **Stop** to exit.



Color Enhancement

- 1 Press **Function, 5, 6**.
- 2 Press  or  to select **WHITE BALANCE** and press **Set**.
To skip White Balance, press  to select **SHARPNESS** or **COLOR DENSITY**.
- 3 Press  or  to adjust the degree of White Balance and press **Set**.
- 4 Repeat Step 2 and Step 3 to adjust the degree of Sharpness and Color Density—**OR**—Press **Stop** to exit.

■ White Balance

This adjusts the hue of the white sections of an image. Lighting, camera settings and other influences will effect the appearance of white. The white parts of a picture may appear to be slightly pink, yellow or some other color. By using this adjustment you can correct this effect and bring the white sections back to pure white.

■ Sharpness

This setting enhances the detail of an image. This is similar to adjusting the fine focus on a camera. If the focus is off a small amount you can not clearly, see the fine details of an image.

■ Color Density

This adjusts the total amount of color in the image. You can increase or decrease the amount of color in an image to improve a picture which may appears washed out or weak.

14 Setting Up the MFC and PC to Work Together

Using the Brother Machine with Your PC

Multi-Function Link[®] Pro software (MFL Pro) turns your Brother machine into a multi-function center, by enabling you to use your fax machine as a printer and a scanner and to use it from Windows[®] applications in your computer.

The MFC 7300C is a 5 in1 multi-function center and the MFC 7400C is a 6in1 multi-function center. Only the MFC 7400C has PC Fax, which is faxing from Windows[®] on your PC. Install the Multi-Function Link[®] Pro and other Brother software from the bundled CD-ROM.



If you have previously installed Brother Multi-Function Link[®] Pro software for another machine, uninstall it first.

Before you install the Multi-Function Link[®] Pro, you must read the README.WRI file in the root directory of the CD-ROM for important last-minute installation information and troubleshooting tips.

Before You Install Multi-Function Link[®] Pro



If you have a USB cable (For Windows[®] 98, 98SE, Windows[®] 2000 Professional and Windows[®] ME users only), see *Using a USB Cable to Connect the MFC to the PC*, page 14-17.



If you have a bi-directional IEEE-1284 compliant parallel cable, see *Using a bi-directional IEEE-1284 compliant to Connect the MFC to the PC*, page 14-2.



Caution

It is important that you hook up your MFC to your computer *before* you install the software.

Computer Requirements

The following are the minimum computer requirements you need to set up and operate the MFC drivers.

COMPUTER REQUIREMENTS				
Windows® Operating System	Speed (or Higher)	RAM	HD Space	CD-ROM Speed
95, 98, 98SE	Pentium 75MHz	24MB (32MB rec.)	50MB	2X
NT 4.0 Workstation	Pentium 75MHz	32MB (64MB rec.)	50MB	2X
2000 Professional	Pentium 133MHz	64MB (128MB rec.)	50MB	2X
ME	Pentium 150MHz	32MB (64MB rec.)	50MB	2X



Use only a shielded parallel interface cable that is IEEE-1284 compliant and/or a USB cable that is no longer than 6 feet long (1.8 meters).

Using a bi-directional IEEE-1284 compliant parallel cable to Connect the MFC to the PC (Using Windows® 95, 98, 98SE, ME, Windows NT® Workstation Version 4.0 and Windows® 2000 Professional)

IMPORTANT

To install the software using Windows NT® Workstation Version 4.0 or Windows® 2000 Professional, you must be logged on as the Administrator.



Before you can connect the MFC to your computer, you must purchase a bi-directional IEEE-1284 compliant parallel cable that is no longer than 6 feet (1.8 meters).



If you are using USB cable, see *Using a USB cable to Connect the MFC to the PC* on page 14-17.

Notice to PC User

A small filter core and cable tie are enclosed in the vinyl bag with your MFC. PLEASE SAVE THESE PARTS. You will need them in the future if you connect the MFC with a Personal Computer. And for optimal performance, use a bi-directional parallel cable with the enclosed Filter core and Cable tie.

When you use a Personal Computer with your MFC, please attach the enclosed Filter core to a Bi-directional parallel cable.

How to Attach the Filter Core to a BI-directional Parallel Cable:

- 1 Attach the Cable Tie 2 inches or less from the Parallel Interface connector.

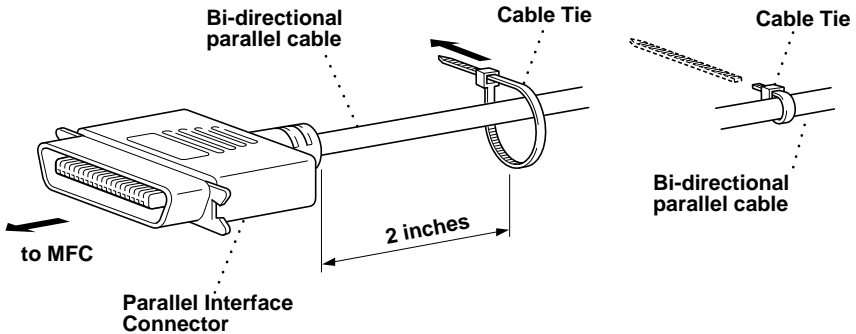

- 2 Attach the Filter Core, pressing until you hear a click, between the Parallel Interface connector and the Cable Tie.

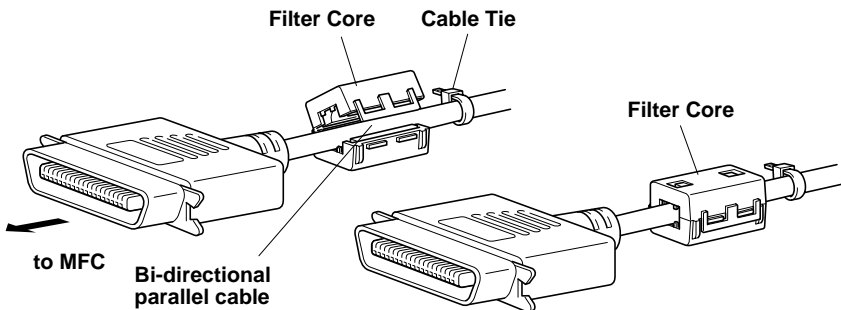

- 3 Unplug the MFC power cord from the electrical outlet before connecting the parallel interface cable.
- 4 Make sure the computer is turned off and unplugged from the electrical power before you connect the interface cable.
- 5 Connect the parallel interface cable to the parallel interface port of the MFC and secure the wire clips.

6 Connect the interface cable to the printer port of the computer and secure it with the two screws.

For the location of your computer's parallel printer port, see the User's Guide for your computer.

7 Before plugging in your computer and turning it on, plug in the electrical cord of the Brother machine, then turn on your PC.

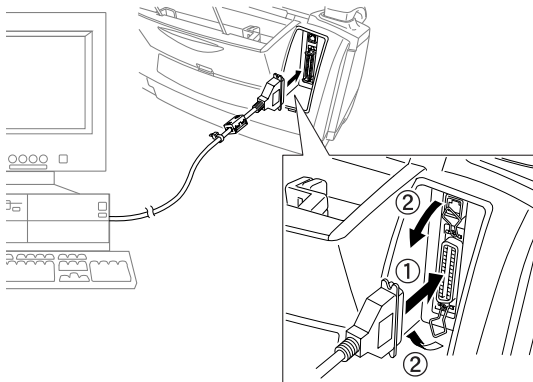

Note Please follow the instructions for the operating system you are using.

Using Windows® 95, 98, 98SE and ME

Note If you are using Windows® 2000 Professional, go to page 14-8.

If you are using Windows NT® Workstation Version 4.0, go to page 14-12.

For Windows® 98, 98SE user:

8 When the Add New Hardware Wizard screen appears, click **Next**.



Note Each operating system has different dialog box. Some text may be different depending on which operating system you are using.

For Windows® 95 user:

Select “**Driver from disk provided by hardware manufacture**” and click **OK**.



For Windows® ME user:

Select “**Specify the location of the driver (Advanced)**” and click **Next**.



The instructions in Step 9 to 18 are for Windows® 98SE.



9 Select (**Recommended**) and click **Next**.



10 Insert the **MFL Pro CD-ROM** into your CD-ROM drive.

- 11 Select **Specify a location** and remove the other check marks, then click **Browse** to locate the file.



- 12 Double-click the CD icon and click the “x:\w9x\para” folder. (X is the drive letter for your CD-ROM drive), then click **OK**.



- 13 Make sure **Specify a location** is selected and click **Next**.



- 14 Make sure your printer driver name is displayed and click **Next**.



- 15 You can type a name for this printer, or you can use the name supplied on screen. When you have finished, click **Finish**.

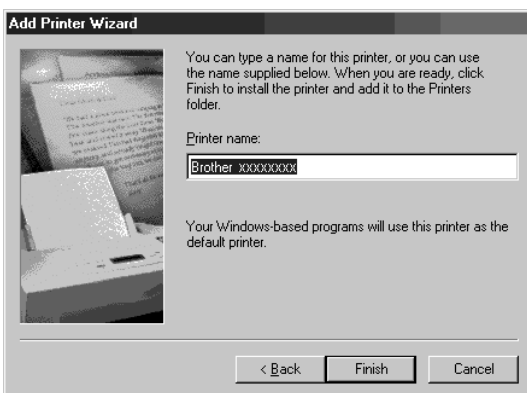

- 16 When the Add New Hardware Wizard displays click **Finish**.



- 17 When the Setup Window appears, and the status bar reaches 100%, the remaining drivers will be copied.

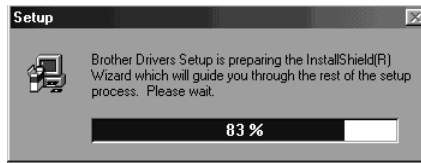

- 18 Click **OK**.



- 19 All the drivers have been installed. Now you can print and scan.



If you want to install PaperPort® or MFL Pro, go to the CD section. (See *Installing the Brother Software*, page 14-27.)

Using Windows® 2000 Professional

- 8 When the Found New Hardware Wizard screen appears, click **Next**.



- 9 Select **(Recommended)** and click **Next**.



- 10 Insert the **MFL Pro CD-ROM** into your CD-ROM drive.

- 11 Select **Specify a location** and remove the other check marks, then click **Next**.



- 12 Click **Browse** to locate the file.



13 Double-click on the CD icon and click on the “x:\w2k\para” (x:is the drive letter for your CD-ROM drive.) folder, then click **OK**.

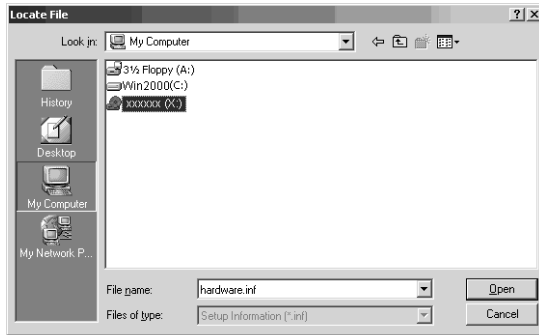

14 Make sure **Specify a location** is selected and click **Next**.

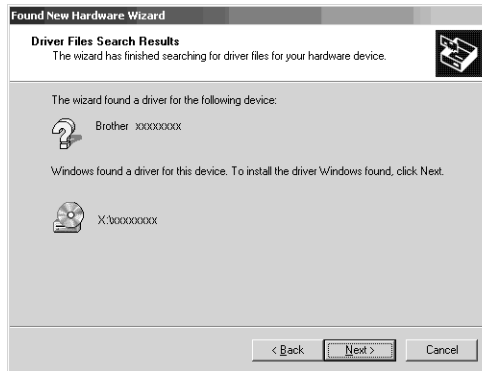

15 Click **Finish**.



- 16 Repeat Steps 8-15 to install the Printer and Scanner drivers.



Note You might see “Digital Signature Not Found” dialog during installation. If you see it, click **Yes** to install the driver.



- 17 Click **Finish**.



- 18 When the Setup window appears, and the Status bar reaches 100%, the remaining drivers will be copied.

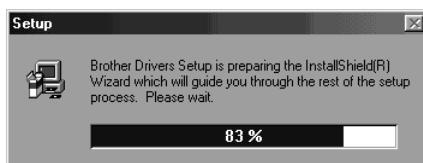

- 10 Select **LPT1:** and click **Next**.

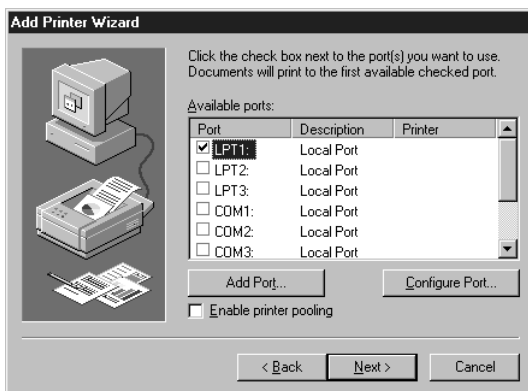

- 11 Insert the **MFL Pro CD-ROM** into your CD-ROM drive. Click **Have Disk...**

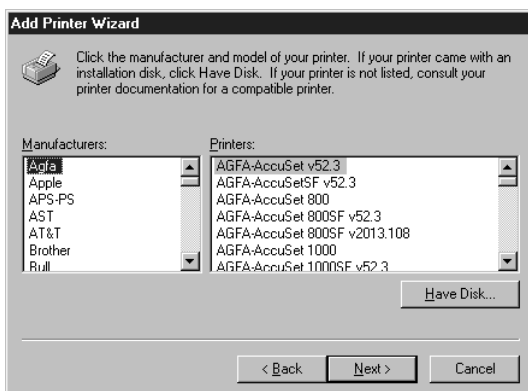

- 12 Click **Browse** to locate the file.

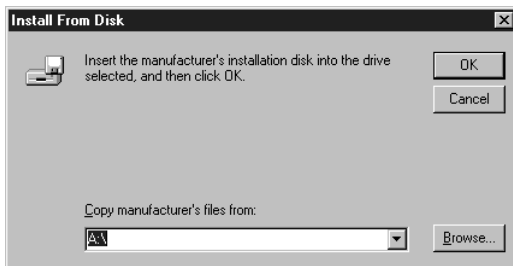

- 13 Double-click on the CD icon and click on the “x:\nt40” (x: is the drive letter for your CD-ROM drive.) folder, then click **Open**.

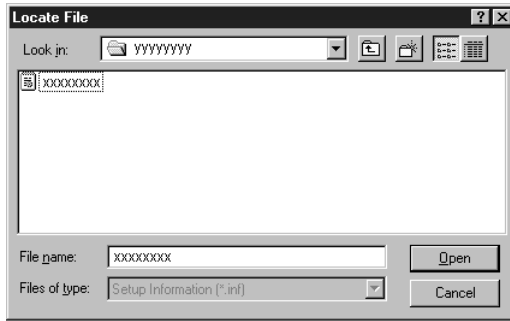

- 14 Make sure **Specify a location** is selected and click **OK**.

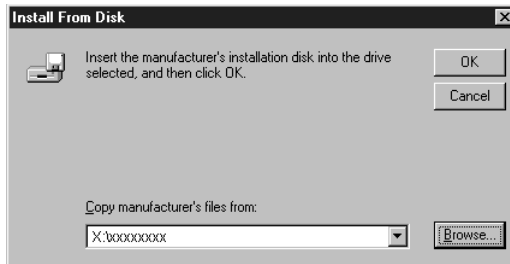

- 15 Select your printer model, then click **Next**. This dialog box may not be displayed on some MFC models.

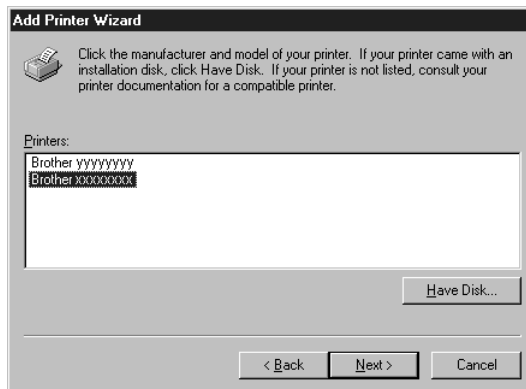

16 Click **Next**.



17 Select **Not Shared**, then click **Next**.

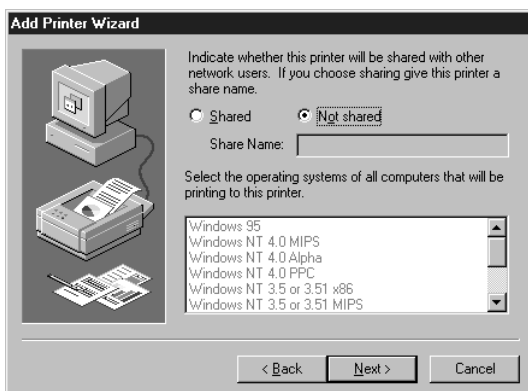

18 Select **Yes (Recommended)** to Print a Test Page and click **Finish**.



- 19 After the test page has been printed, click **Yes**.



- 20 Now the printer driver has been installed, and you can see the driver in the Printer list.

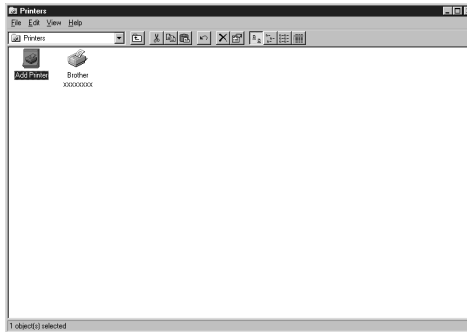

- 21 To install the other drivers (such as Scanner), you will have to install them manually. Click the **Start** button in the task bar, then select **Run**. Enter **x:\nt40\setup\setup.exe** then click **OK**.

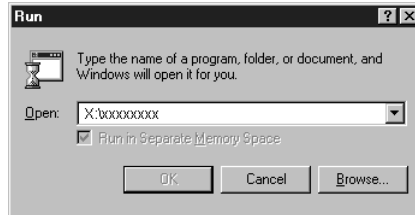

- 22 When the Setup Window appears, and the status bar reaches 100%, the remaining drivers will be copied

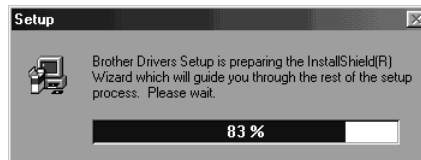

23 Click OK.



24 All the drivers have been installed. Now you can print and scan.

Note If you want to install PaparPort®, MFLPro, go to the CD section. (See *Installing the Brother Software* on page 14-27.)

Using a USB Cable to Connect the MFC to the PC (Using Windows® 98, 98SE, ME and Windows® 2000 Professional Only)

IMPORTANT

To install the software using Windows® 2000 Professional, you must be logged on as the Administrator.

Note Before you can connect the MFC to your computer, you must purchase a USB cable that is no longer than 6 feet (1.8 meters).

Note If you are using a bi-directional IEEE-1284 compliant parallel cable, see *Using a bi-directional IEEE-1284 compliant parallel cable to Connect the MFC to the PC* on page 14-2.

Notice to Computer Users

A small filter core and cable tie are enclosed in a vinyl bag with your MFC. **PLEASE SAVE THESE PARTS.** You will need them in the future if you connect the MFC to a Computer. For optimal performance, use a USB Cable with the enclosed Filter core and Cable tie.

When you use a Computer with your MFC, please attach the enclosed Filter core to a USB Cable.

- 1 Attach the cable tie 2 inches or less from the end of the USB Cable that will be connected to the MFC.
- 2 Attach the filter core between the USB Cable Connector and the Cable Tie by pressing until you hear a click.

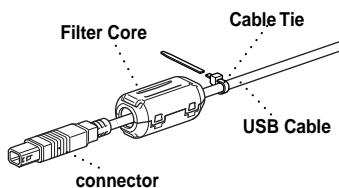
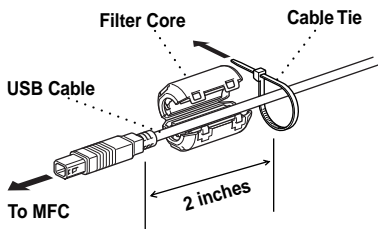

- 3 After you have set up the MFC and checked that it is working properly, make your PC is turned off.
- 4 Connect the USB cable to both the MFC and the PC.

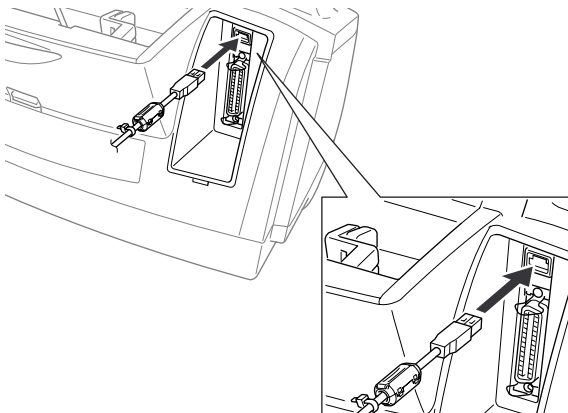

- 5 Turn on your PC.

Using Windows® 98, 98SE, ME

Note If you are using Windows® 2000 Professional, go to page 14-24.

- 6 For Windows® 98, 98SE users: When the Add New Hardware Wizard screen appears, click **Next**.

Note Each operation system has different dialog.



For Windows® ME Users:

Select **Specify the location of the driver (Advanced)**, then click **Next**.



- 7 Select **(Recommended)** and click **Next**.



- 8 Insert the **MFL Pro CD-ROM** into your CD-ROM drive.

- 9 Select **Specify a location** and remove the other check marks, then click **Browse** to locate the file.



- 10 Double-click the CD icon and click the “x:\W98\usb” (x: is the drive letter for your CD-ROM drive) folder, then click **OK**.

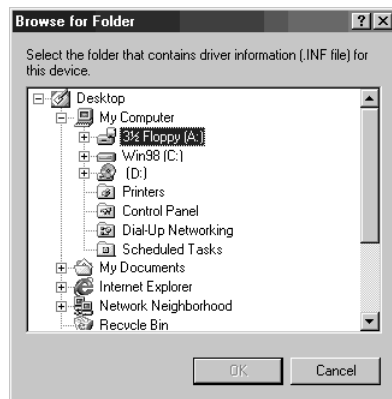

- 11 Make sure **Specify a location** is selected and click **Next**.



- 12 Click **Next**.



-  If the Insert Disk Wizard appears, remove the **MFL Pro CD-ROM** and insert the **Windows® 98/98SE/ME CD-ROM** (to get the Windows® standard driver) and click **OK**.

- 13 Click **Finish**.

(If you inserted the **Windows® 98/98SE/ME CD-ROM**, remove the **CD-ROM** and reinsert the **MFL Pro CD-ROM**)



- 14 After the **Composite USB Device** is installed and the Add New Hardware Wizard reappears, click **Next**.



- 15 Select **(Recommended)** and click **Next**.



- 16 Select **Specify a location** and click **Next**.



17 Click **Next**.



18 When the Add New Hardware Wizard displays the message that installation is completed, click **Finish**.



To install all the drivers, repeat Steps 4 to 12.

19 After the USB Composite Device, PhotoCapture Center (For MFC 7400C only) Fax Modem, Scanner and Printer Drivers have been installed, select **BRUSB: USB Printer Port** as the printer port and click **Next**.

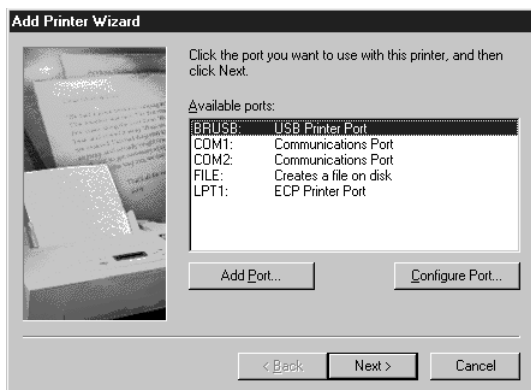

- 20 Enter a name for the printer, or you can use the name supplied. When you have finished, click **Next**.



- 21 Select **Yes (Recommended)** to print a Test Page and click **Finish**.

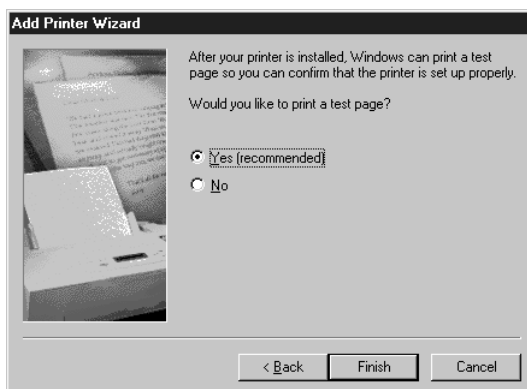

- 22 After the test page has been printed, click **Yes**.



- 23 When the Add New Hardware Wizard displays the message that the software has been installed, click **Finish**.



- 24 All the drivers have been installed. Now you can print and scan.



If you want to install **PaparPort®** or **MFLPro**, go to the CD section. (See *Installing the Brother Software*, page 14-27.)

Using Windows® 2000 Professional

- 6 When the Found New Hardware Wizard screen appears, then click **Next**.



- 7 Select **(Recommended)** and click **Next**.



- 8 Insert the **MFL Pro CD-ROM** into your CD-ROM drive.
- 9 Select **Specify a location** and remove the other check marks, then click **Next**.

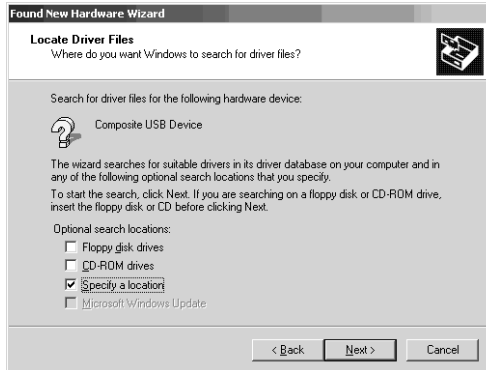

- 10 Click **Browse** to locate the file.



- 11 Double-click on the CD icon and click on the **"x:\W2K\usb"** (x: is the driver letter for your CD-ROM drive) folder, then click **OK**.

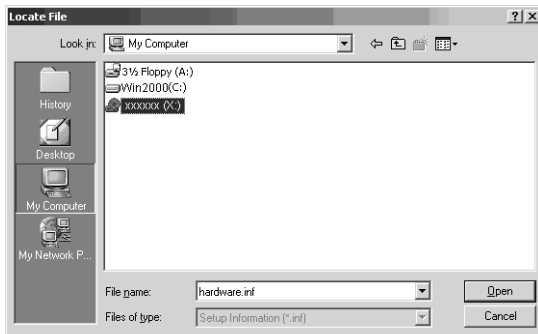

- 12 Make sure **Specify a location** is displayed.



13 Click Next.

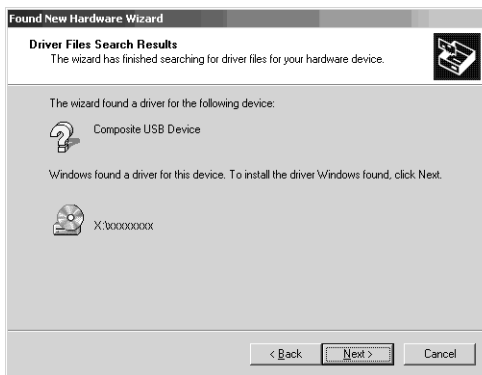

14 Click Finish.



15 To install the other drivers, repeat Step 4 to 12.

Note You might see "Digital Signature Not Found" dialog during installation. If you see it, click **Yes** to install the driver.

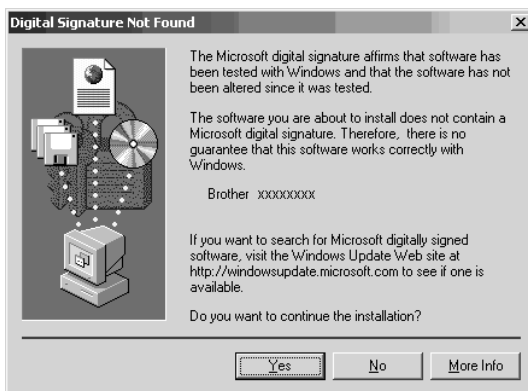

16 All the drivers have been installed. Now you can print and scan.

Note If you want to install PaperPort[®], or MFL Pro, go to the CD section. (See *Installing the Brother Software* on page 14-27.)

Installing the Brother Software

IMPORTANT

You must install drivers for Printer and Scanner before you install the software (MFL Pro), See *the beginning of this chapter.*)

- 1 Insert CD-ROM into your CD-ROM drive.

A window appears listing the following options:

(If this window does not appear, please use Windows Explorer to run the setup.exe program from the root directory of the Brother CD.)



Please note that the software will automatically detect the operating system you are using and will display it at the bottom of the screen.



If you are using Windows® 2000 Professional or NT® 4.0, before you can install the software, you must be logged on as the Administrator.

To install Multi-Function Link® Pro (Main Application):

- 1 Click on the first button “Install MFL-Pro”.

The following screen *will appear*:

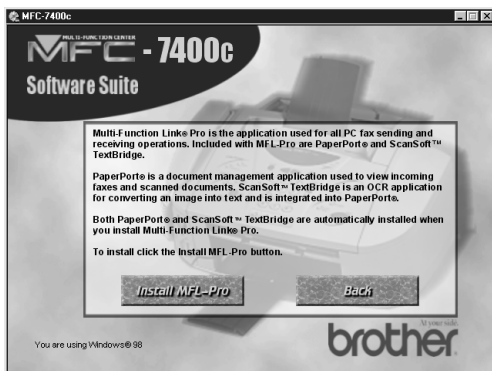

2 Follow the instructions on the screen. ScanSoft™ PaperPort® will be installed first, then MFL-Pro will be installed. After the installation, you must restart your PC.

🔍 Clicking **Install MFL-Pro**, will install the Multi-Function Link® Pro, ScanSoft™ PaperPort®, and ScanSoft™ TextBridge® OCR applications.

🔍 Multi-Function Link® Pro includes Smith Micro PC FAX software (MFC 7400C only), Remote Setup and True Type fonts. PaperPort® is a document management application for viewing incoming faxes and scanned documents. ScanSoft™ TextBridge® is an OCR application that converts an image into text and integrates it into PaperPort®.

To Install Automatic E-mail Printing (Optional Application):

1 Click on “*Install E-mail Print*” from the main CD-ROM screen.

🔍 *This is optional software and will not required for printing, faxing and scanning operations.*

The “Automatic E-mail Print” option is NOT available for Windows NT® 4.0 and Windows® 2000 Professional.

The following window appears:

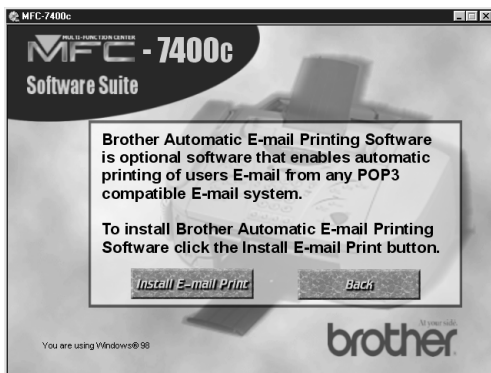

2 Click “*Install E-mail Print*” to install this feature.

To Register Your MFC 7300C/MFC 7400C On-Line (For USA only):

- 1 Click “*On-Line Registration*” to go on-line to register your product from the main menu.

(On-Line Registration is only available for users in the USA.)

You can also mail in the “Warranty Registration Card” which is included in the carton.

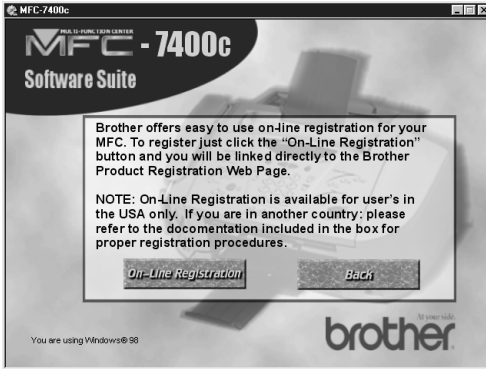

To view On-Line Documentation:

- 1 When you click “*On-Line Documentation from the main menu*”, the following screen appears:



To view documentation, click on the appropriate button.

Please note that you can install Adobe Acrobat Reader at this time, if you do not have it on your system already.

To Install PhotoPrinter Pro For MFC 7400C only);

- 1 Click “*Install PhotoPrinter Pro*” from the main menu and the following screen appears:

Note: *PhotoPrint Pro only works with Windows® 98/98SE, Windows® 2000 Professional, Windows® ME, when you are using a USB cable to connect your MFC to the PC.*

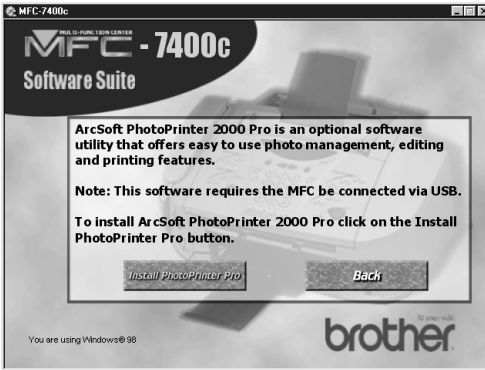

- 2 Click “*Install PhotoPrinter Pro*” to install program.

To View Brother Support Information:

- 1 Click “*Brother Support*” from the main menu to get all the contact information you need if you have to get in touch with our Customer Service, or Brother Authorized Service Center.

The following screen appears:



- If you click on “*Brother Home Page*”, you will go to our web site, www.brother.com.
 - If you click on “*Support Information*”, you will open up a text document listing all the contact phone numbers, should you have to get in touch with our Customer Service. (For USA and Canada only)
 - If you click on “*Brother Mall.com*”, (www.brothermall.com) you’ll be taken to our on-line shopping mall, where you can get additional information about Brother products and services. (For USA only)
- 2 Click “*Back*” to return to the main page, or click “*Exit*” if you are finished with your setup.

Helpful Hints for Windows® 95/98/98SE/ME/ 2000 Professional or Windows NT® 4.0

The installer automatically sets the printer port to the parallel interface, BRMFC (for Windows® 95/98/98SE/ME) and BMFC (for Windows NT® Workstation 4.0 and Windows® 2000 Professional).

IMPORTANT

Please see the README.WRI file in the root directory of the CD-ROM for last-minute important installation and troubleshooting information.



To uninstall Multi-Function Link® Pro, click the Uninstall icon in the Brother MFL Pro Program group and follow the instructions on the screen,

Receiving Faxes into the PC (For MFC 7400C only)

To receive faxes into your PC through the MFC:

- 1 Make sure the MFC is connected to the PC. The PC and the Multi-Function Link® Pro Main Menu must be running at all times. (See *Installing the Brother Software*, page 14-27.)
- 2 Load the Multi-Function Link® Pro software into your PC. (See *Installing the Brother Software*, page 14-27.)
- 3 On your PC in the Multi-Function Link® Pro software:
 - A Select Setup from the *Preferences* pull-down menu in the Main Menu.
 - B Under Answer Mode select Fax only.
 - C Click the OK button.

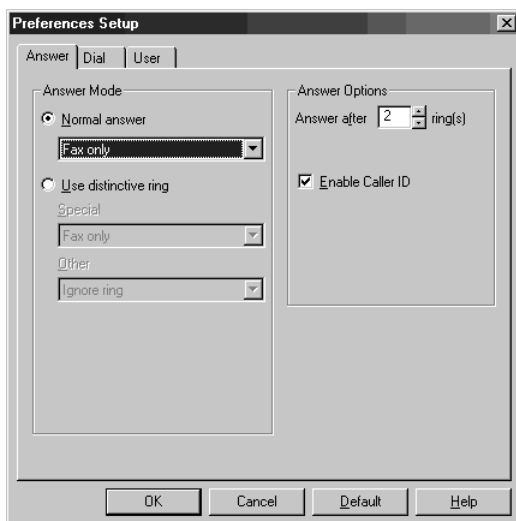

15 Using the MFC as a Printer

Features

The Multi-Function Center offers you many features you'll find in a high quality ink jet printer.

Fast Printing Speed—Using Draft mode, you can print 10 pages per minute in full color.

Brilliant 4-Color Output at 300 dpi—Printing at 300 dpi resolution gives you normal resolution output.

Brilliant 4-Color Output at 600 dpi—Printing at 600 dpi resolution on special coated paper or glossy paper gives you high resolution output.

Brilliant 4-Color Output at 1200 dpi—Printing at 1200 dpi resolution on special coated paper or glossy paper gives you highest resolution output.

Low Running Cost—Whenever you run out of a particular color ink, you'll replace only the cartridge that's empty.

Bi-directional Parallel Interface—The parallel interface allows bi-directional (IEEE 1284 compliant) communication with your computer.

USB—Universal Serial Bus Interface allows for fast communication with your computer.

Straight Paper Path—The MFC can use various types of paper: plain paper, Ink Jet Paper (Coated Paper), glossy paper, transparencies, and envelopes. Using the appropriate paper reduces the occurrence of paper jams. For complete information about what kinds of paper to use with the MFC, please read Chapter 3 in this manual.

Printer Driver

You can change the following printer settings when you print from your computer:

- Quality (Speed) /Media
- Color Matching
- Halftone/TRUE2LIFE

Choosing the Right Kind of Paper

To achieve high quality printing using your MFC, it's very important to select the right kind of paper. Be sure to read "About Brother Paper" page 3-1 of Chapter 3 in this manual before selecting and purchasing paper for the MFC.

Multi-purpose Sheet Feeder

The multi-purpose sheet feeder can feed plain paper, coated paper, glossy paper, transparencies, envelopes, and organizer paper (K, L). When the MFC receives data from your computer, it begins the print process by loading paper from the multi-purpose sheet feeder.

- 1 Select the print command from your PC.
- 2 Your PC sends a print command and data to the MFC. The screen displays RECEIVING DATA.
- 3 If there are more pages, the MFC begins to print the next page automatically.
- 4 When the MFC finishes printing all data, it returns to display the date and time.

Note

You can select paper source, paper size, and orientation in your application software. If your application software does not support your custom paper size, select the next larger paper size. Then adjust the print area by changing the right and left margins in your application software.

Loading Paper

You can use plain paper, coated paper, transparencies, glossy paper, envelopes and organizer (K, L) in the multi-purpose sheet feeder. (See Chapter 3 for more information about paper types.)

- 1 Open the control panel cover by pulling it toward, you then lift the top cover toward the back. When you want to print on regular paper, keep the purple paper thickness adjustment lever up. When you want to use thick paper, press the lever down. Then, close the top cover and the control panel cover.

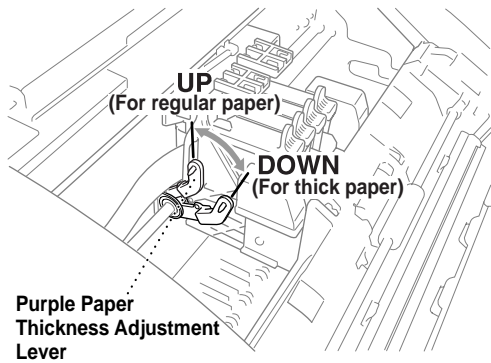

- 2 Remove any paper in the Feeder, and load the new paper. Fan the stack of paper before loading.
- 3 Load the paper stack with the printing (coated) side facing up. Adjust the paper guide. Make sure the paper is stacked below the arrow. You can load up to approximately 100 sheets of 20 lb (75g/m²) plain paper.



If you see ink smudges on the top center of the printed pages, press the purple thickness adjustment lever down.

Simultaneous Printing/Fax

Your MFC can print data from your computer while sending or receiving a fax, or while scanning information into the computer. However, when the MFC is copying or receiving a fax on paper, it pauses the PC printing operation, and resumes when copying or fax receiving is complete. Fax sending will continue during PC printing.

Printer Operation Keys



Reset Key

If the screen displays **REMAINED DATA**, you can clear data remaining in the printer memory by pressing **Reset**.

Ink Management Key

When you press **Ink Management**, the LCD displays:

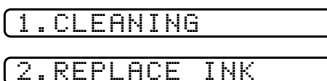

If you are having trouble with one of the ink colors, you may need to clean the print head. (See P.24-8.)

If you got an error message **NEAR EMPTY** or **INK EMPTY**, you will need to replace the ink cartridge for the appropriate color. (See *Troubleshooting and Routine Maintenance*, Chapter 24.)

Turning Off Bi-directional Printing

You can further improve print quality by turning off bi-directional printing and setting the MFC to print in one direction only. However, this will reduce print speed by one half.

- 1 Press **Function, 2, 3**.
- 2 Press **2** to select OFF (or **1** to select ON).

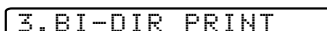

16 Printer Driver Settings

Using the Brother MFC 7300C/MFC 7400C Printer Driver

The Brother MFC 7300C/MFC 7400C printer driver enables you to change settings and override defaults as you change your paper, document type, and colors for printing. In the Brother MFC 7300C/MFC 7400C on BRMFC: Properties dialog box there are two tabs: Paper and Quality/Color, so you can change print properties as needed.

The Paper Tab

The paper tab screen allows you to set up the Paper Size, Paper Source, Orientation, Scaling, and Copies.

To access the Brother printer driver, select **Print** from the File menu. In the Print dialog box, select **Brother MFC 7300C/Brother MFC 7400C** from the Name drop down list. Click the Properties button. The Brother MFC 7300C/MFC 7400C on BRMFC: Properties dialog box will appear:

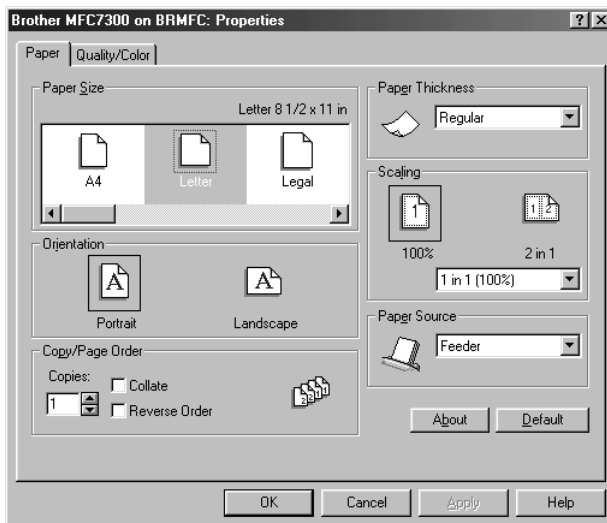

Select the **Apply** button to apply your selected settings.

To return to the default settings, click the **Default** button, then click the **Apply** button.

Paper Size

You can select from the following sizes of paper and envelopes:

Letter (US)	8 1/2 x 11 inches (215.9 x 279.4 mm)
Legal (US)	8 1/2 x 14 inches (215.9 x 355.6 mm)
Executive (US)	7 1/4 x 10 1/2 inches (184.2 x 266.7 mm)
A4	210 x 297mm
A5 (International)	5.8 x 8.3 inches (148 x 210 mm)
Post Card (US)	5 x 7 inches (127 x 177.8 mm)
Photo Card (US)	4 x 6 inches (101.6 x 152.4 mm)

Envelopes

B5 (International envelope)	6.9 x 9.8 inches (176 x 250 mm)
C5 (International envelope)	6.4 x 9 inches (162 x 229 mm)
COM-10	4 1/8 x 9 1/2 inches (104.8 x 241 mm)
DL (International envelope)	4.3 x 8.7 inches (110 x 220 mm)
Monarch (US envelope)	3 7/8 x 7 1/2 inches (98.4 x 190.5 mm)
Organizer K	3 3/4 x 6 3/4 inches (95.3 x 171.5 mm)
Organizer L	5 1/2 x 8 1/2 inches (139.7 x 215.9 mm)

User Defined Paper Size

The printer can handle any paper size within the following range:

Minimum	3.5 x 5 inches	(90 x 127 mm)
Maximum	8.5 x 14 inches	(216 x 355.6 mm)

In this option, you can specify a custom paper size and save it by following this procedure:

- 1 Measure the paper size you want to use.
- 2 Select User Defined... in the paper size option.
- 3 Enter a unique name for your paper in the Custom Paper Size Name box.
- 4 Select either inch or mm for the unit of measure.
- 5 Type in the length and width.
- 6 Click the **Save** button to store the size. If necessary, you can delete a preset size by choosing the Delete button.



Your Windows application software may override this setting. Make sure you have set the proper paper size in your application software. In addition, check the margin settings when you select the smallest paper size. If they are too large, it may result in nothing being printed.

Orientation

Print orientation may be **Portrait** or **Landscape**. Portrait orientation means the page is taller than it is wide when you view the printed text upright. Landscape orientation means the page is wider than it is tall when you view the printed text upright.

Copies

The **Copies** selection tells Windows how many copies you want to print from a software application.



This setting is independent of the “copies selection” that may be available within the print menus of your software application.

Do not use the two selections simultaneously!

Collate

In multiple page jobs that are **uncollated**, several copies of Page 1 are printed followed by several copies of Page 2, followed by several copies of Page 3, etc. For example, for 2 copies of a 3 page document, the MFC prints Page 1, Page 1, Page 2, Page 2, Page 3, and Page 3 in order.

In multiple page jobs that are **collated**, a complete set of pages in a job are printed followed by another complete set of pages. For example, printing 2 copies of a 3 page document, the MFC prints Page 1, Page 2, Page 3, then Page 1, Page 2, and Page 3 in order. In this case, the MFC starts printing after processing all the print data so that it takes a longer time for collated printing than uncollated printing.

Reverse Order

The MFC normally prints Page 1 and ejects it face-up so that the following pages are stacked on top of previous pages. (Page 5, Page 4, Page 3 Page 1) When you want to get correct-ordered printouts, use this function. The MFC spools the job in your computer and sends the data starting from the last page to the printer. Since the MFC prints from the last page forward, the printouts are stacked Page 1, 2, 3, ...Page 5. Please note that this function takes more time.

Paper Thickness

You can use the following types of paper thickness for your printer. To get the best position printing, select the correct types of paper thickness you wish

Regular

Thin

Thick

Thicker

When you use ordinary plain paper, select Regular.

When you use thin paper, select Thin.

When you use envelopes or thicker paper, select Thick or Thicker.

Scaling

Use this function to reduce or enlarge your document, from 50% to 200%.

2 in 1

Two pages are printed on one sheet at a reduced size. If you checked the “2 in 1 box”, you cannot specify the scaling percentage manually.



If your application software contains a similar function to this, both settings will be effective. **Do not use the two selections simultaneously!**

Paper Source

Feeder

The **multi-purpose sheet feeder** is primarily used for printing on standard-size paper and envelopes.

The Quality/Color Tab

The Quality/Color tab enables you to select the print quality, media, colors (matched to PC monitor, custom colors, or mono), and document type.

Click the Quality/Color tab to display this screen:

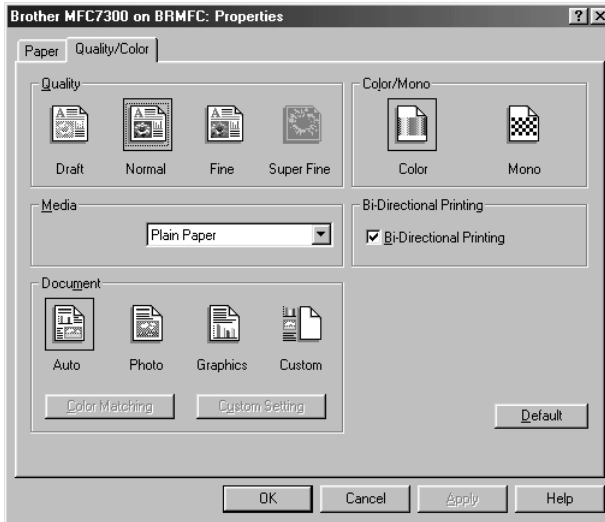

Select the **Apply** button to apply your selected settings.

To return to the default settings, click the **Default** button, then click the **Apply** button.

Quality

Select the print quality. The print quality and speed are related. Higher quality takes a longer time to print.

- Draft:** 300 x 150 dpi. The fastest print mode (approximately two to four times faster than normal mode) and gives lower ink consumption. Use this mode to print large volume documents or a document for proofing.
- Normal:** 300 x 300 dpi. Recommended mode for ordinary printouts. Good print quality with comfortable printing speed.
- Fine:** 600 x 600 dpi. Better print quality than normal and faster print speed than Super Fine.
- Super Fine:** 1200 x 1200 dpi. Use this mode to print precise images such as photographs. Since the print data is much larger than normal mode, processing time, data transfer time, and printing time will be longer.

Media

Select the media (type of paper). The MFC changes the way it places dots depending on the selected media type. To get the best print output, make sure to select the correct media type.

Selecting media type changes the print quality selection to the most suitable one as listed below. We recommend that you print with the preset quality for best printing result.

Paper Type	Suitable print quality
Plain Paper	Normal
Ink Jet Paper (Coated Paper)	Fine
Glossy Paper	Super Fine
Photo Graphic Paper	Super Fine
Transparency	Normal
Transparency (mirror)	Normal



Use only genuine Brother Ink Jet Paper (Coated Paper), Glossy Paper, or Transparencies to get the best print quality. Non-Brother special paper may not produce the best quality.

Document

The printer driver will select the most suitable color matching method depending on your document type. Generally, text and business graphics are printed vividly and photographic images are printed softly.

■ Auto

The printer driver automatically selects the document type. In most cases, we recommend using the Auto setting.

■ Photo

Select this mode for Photographic images.

■ Graphics

Select this mode for documents that contain text or business graphics (charts or clip art).

■ Custom

If you want to select the color matching method and halftone method manually, select this mode and press the Color Matching and the Custom Setting button to access further settings.

Color/Mono

Color

When your document contains color and you want to print it in color, select this mode. Only generic colors will appear on the printout (unless you also select color matching).

Mono

Select this mode if your document has only black and gray scale text and/or objects. Mono mode makes the print processing speed faster than color mode. If your document contains color, selecting Mono mode prints it in 256 levels of gray scale.

Color Matching

You can select the color matching method manually. Select the best one for your document.

■ Match Monitor

Suitable for photographic images. Color is adjusted to get the closest color match to the PC monitor.

■ Vivid Color

Suitable for business graphics such as charts, graphs, and text. The color is adjusted to give more vivid color.

Custom Setting

You can customize your settings by selecting the type of Halftone or True 2 Life.

Halftone Pattern

The MFC can use several methods to arrange where to place dots to express halftones. There are some predefined patterns used to place dots and you can select which one is used for your document. Select the appropriate method.

■ Photo

This method creates smooth halftones so that this is suitable for photographic images. It takes more time to process data, but this can express more levels of halftones and creates more natural images.

■ Cluster

This is suitable for business graphics such as charts, graphs and drawings, since this creates more sharp printouts. Moreover, the processing time is shorter.

True2Life

■ True2Life ON

Adjusts the color in the image for better print quality. Print time will be longer with True2Life set to ON.

■ Sharpness

This setting enhances the detail of an image. This is similar to adjusting the fine focus on a camera. If the focus is off a small amount you can not clearly see the fine details of an image.

■ Color Density

This adjusts the total amount of color in the image. You can increase or decrease the amount of color in an image to improve a picture which may appear washed out or weak.

■ White Balance

This adjusts the hue of the white sections of an image. Lighting, camera settings and other influences will effect the appearance of white. The white parts of a picture may appear to be slightly pink, yellow or some other color. By using this adjustment you can correct this effect and bring the white sections back to pure white.

■ Brightness

Change the brightness of the whole image lighter or darker. Moving the scroll bar to the left makes your image darker and moving the scroll bar to the right makes your image lighter.

■ Contrast

Change the contrast of an image. Darker sections will be more dark and lighter sections will be more light as you increase the contrast. Increase the contrast

when you want an image to be clearer. Decrease the contrast when you want an image to be more subdued.

■ **Red**

Increase the intensity of the Red color to add red to the whole image.

■ **Green**

Increase the intensity of the Green color to add green to the whole image.

■ **Blue**

Increase the intensity of the Blue color to add blue to the whole image.

17 Using the Windows®-Based Brother Control Center

Brother Control Center

The Brother Control Center is a software utility that pops up on the PC screen whenever paper is placed in the automatic document feeder. This allows you to quite easily, with very few mouse clicks, access the most frequently used scanning applications. Using the Control Center eliminates the need to manually launch the specific applications.

The Brother Control Center provides three categories of functions:

- 1 Scan directly to a file, E-mail, word processor or graphic application of choice
- 2 Enhanced copy functions, such as Two on One Copying
- 3 PC Faxing using the Brother MFL Pro PC Fax software (For MFC 7400C only)

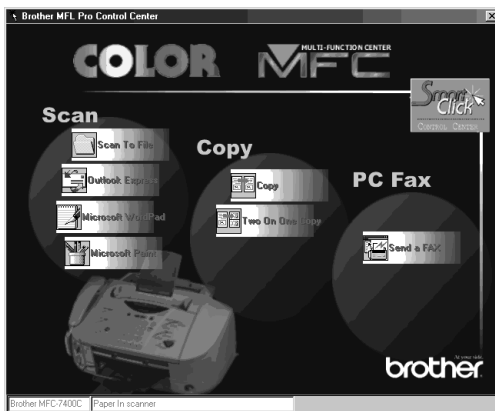
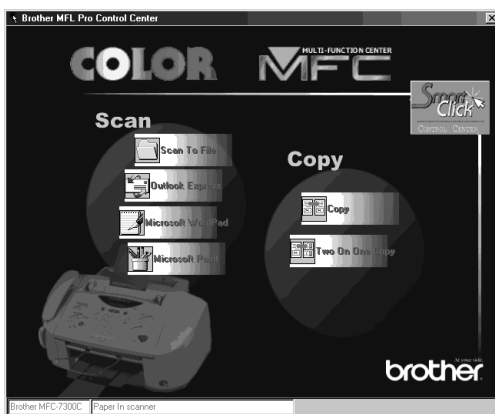



AutoLoad the Brother Control Center

The Control Center is initially configured to automatically load each time Windows[®] is started. When the Control Center is loaded, the Control

Center  icon will appear in the task bar. If you don't want the Control Center to load automatically, you can turn off AutoLoad.

How to Turn Off AutoLoad

- 1 Left click the Control Center  icon and click **Show**.
- 2 When the Control Center icon appears, left click on the Smart Click  Control Center button. A dialogue box with a check box labeled “AutoLoad Pop-up” will appear:

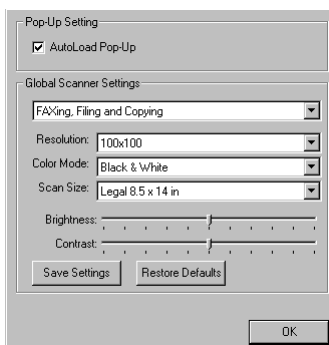

- 3 Uncheck the AutoLoad Pop-Up option.

Using the Scan Keys

You can use the Scan keys on the control panel to scan originals into your word processing, graphics or E-mail applications. The advantage of using the Scan keys is that you avoid the mouse clicks required to scan from your PC.

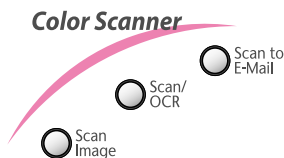

Using the Control Panel Keys

-  If you have connected a Macintosh, the control panel keys will not work with your computer. Please see page 22-1.

Before you can use the Scan keys on the control panel, you must have connected the MFC to your Windows® based PC and loaded the appropriate Brother Drivers for your version of Windows®. When you are ready to use the Scan keys, make sure the Brother Control Center application is running on your PC. (For details about how to configure the Brother Control Center buttons to launch the application of your choice using the Scan keys, see Chapter 15, *Using the Windows® Based Brother Control Center*.)

Scan Image

You can scan a color picture into your graphics application for viewing and editing.

- 1 Place your original face down in the ADF.
- 2 Press **Scan Image**.

SCANNING: IMAGE

The MFC will scan the original and send a color image to your graphics application.

Scan/OCR

If your original is text, you can have it automatically converted by ScanSoft™ TextBridge® to an editable text file and then displayed in your word processing application for further editing.

- 1 Place your original face down in the ADF.
- 2 Press **Scan/OCR**.

- 3 The MFC will scan the original perform OCR in ScanSoft™ TextBridge®, and then display the result in your word processing application for viewing and editing.

SCANNING: OCR

Scan to E-mail

You can scan either a black and white or a color original into your E-mail application as a file attachment. Although the Brother Control Center can be configured to send only black and white or color file attachments at one time, you can easily change this setting. (For details see Chapter 15, *Using the Windows® Based Brother Control Center*.)

- 1 Place the original face down in the ADF or on the scanner glass.
- 2 Press **Scan to E-mail**.

- 3 The MFC will scan the original, create a file attachment, and launch your E-mail application, displaying the new message waiting to be addressed.



SCANNING: E-MAIL

Brother Control Center Features

Auto Configuration

During the installation process the Control Center checks your system to determine the default applications for E-mail, word processing and graphics viewer/editor. For example, if you are using Outlook as your default E-mail application, the Control Center automatically will create a link and a scanning application button for Outlook.

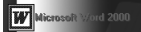
You can change a default application by right clicking on any of the scan buttons in the Control Center and selecting a different application. For example,

you can change a scan button from MS Word  to MS Word Pad  by changing the application that is listed for the Word Processor.



Scanning Operations

Scan to File—allows you to scan directly to a disk file with two mouse clicks. You can change the file type, destination directory and file name, as needed.

Scan to E-mail—enables you, with just two mouse clicks, to scan a picture or text document directly into an E-mail application as a standard attachment. You have the option of selecting the file type and resolution for the attachment.

Scan to Word Processor—enables you to scan a text document, run ScanSoft TextBridge OCR and insert the text original (not graphic image) into a word processing file with just two mouse clicks. You have the option of selecting the destination word processing program, such as Word Pad, MS Word, Word Perfect, etc.

Scan to Graphic Application—allows you to scan an image directly into any graphic viewer/editor application. You can select the destination application, such as MS Paint or Corel PhotoPaint.

Copy Operations

Copy—allows you to use the PC and any Windows® printer driver for enhanced copy functions. You can scan the page on the Brother MFC and print the copies using any of the features of the Brother MFC printer driver—**OR**—you can direct the copy output to any standard Windows® printer driver installed on the PC.

Two on One Copy—allows you to use the Two on One page feature of the Brother printer driver to copy two original pages onto a single output page. This feature creates a thumbnail of each page and prints both images on a single page.

PC Fax Operation (For MFC 7400C only)

Send a Fax—allows you to scan a picture or text original and automatically send the image as a fax from the PC using the Brother MFL Pro fax software.

Scanner Settings for Scan, Copy and PC Fax Buttons

When the Pop-Up screen is displayed, you can access the Scanner Settings window.

Click the Smart Click  icon at the top right of the Brother Control

Center screen—**OR**—Click the **Modify Settings...** button on any of the Configuration screens.

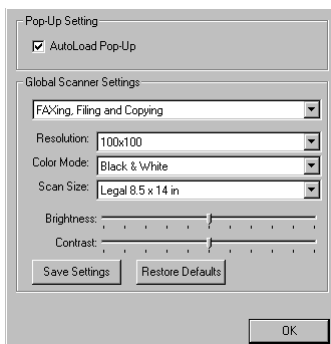

Global Settings

AutoLoad Pop-Up—Click this checkbox if you want Brother MFL Control Center to load when you boot your computer.

Setting Up the Scanner Configurations

The Pop-Up application stores eight different scanning modes. Each time you scan an original, you will choose the most appropriate scanning mode from the following:

Faxing, Filing and Copying
Text for OCR
Photos
Photos (High Quality)
Photos (Quick Scan)
Custom
Draft Copy
Fine Copy

Each mode has its own set of stored settings. You can keep the factory default settings or change them at any time:

Resolution—Select the scanning resolution you most frequently use.
Color Mode—From the pull-down list, select
Scan Size—From the pull-down list, select
Brightness—Slide the adjuster from 0% to 100%
Contrast—Slide the adjuster from 0% to 100%

Click **OK** to save your changes. If you make a mistake or later decide to return to the original default setting, just click the **Restore Defaults** button when the scanning mode is displayed.

To access the Scanner Configurations screen:

- 1 Place the original in the ADF.
- 2 Right-click the appropriate Control Center button to display *Configurations...*, then click it. The configuration screen for that **Control Center** button will appear.
- 3 To save your settings, press the **OK** button—**OR**—To return to the factory default settings, press the **Restore Defaults** button.

Perform an Operation from the Control Center Screen

If you see this screen it means you left-clicked a button in the Control Center window without first placing an original in the ADF.

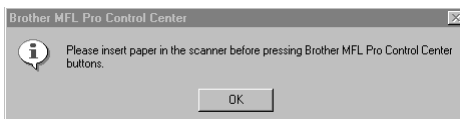

Place the original in the Brother machine's ADF, then click **OK** to return to the Control Center screen.

Scan to File

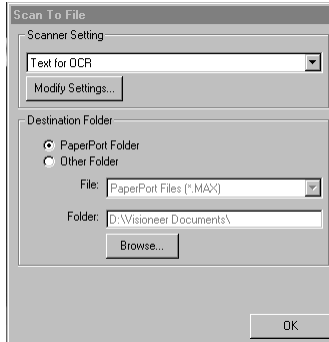

Scanner Settings

From the pull-down list, select the scanning mode that is appropriate for the type of file: Faxing (For MFC 7400C only), Filing and Copying; Text for OCR; Photos; Photos (High Quality); Photos (Quick Scan); Custom; Draft Copy or Fine Copy.

To change any of the settings for that mode, click the **Modify Settings...** button.

Destination Folder

PaperPort Folder—Select this checkbox to scan the original into your PaperPort folder.

Other Folder—Select this checkbox, to scan the original as another file type and/or into another directory/folder.

File—If you selected Other Folder, from the pull-down list select the type of file:

- PaperPort Files (*.MAX)
- Self Viewing Files (*.EXE)
- PaperPort 5.0 Files (*.MAX)
- PaperPort 4.0 Files (*.MAX)
- PaperPort 3.0 Files (*.MAX)
- Windows Bitmap (*.BMP)
- PC Paintbrush (*.PCX)
- Multi-page PCX (*.DCX)
- JPEG Image Files (*.JPG)
- TIFF-Uncompressed (*.TIF)
- TIFF Group 4 (*.TIF)
- TIFF Class F (*.TIF)
- Multi-Page TIFF-Uncompressed (*.TIF)
- Multi-Page TIFF Group 4 (*.TIF)
- Multi-Page TIFF Class F (*.TIF)
- PDF Files (*.PDF)
- Portable Network Graphics (*.PNG)
- FlashPix (*.FPX)
- HFX Fax Files (*.HFX)

To Search your system for the directory and folder you want, click the **Browse...** button. Click **OK** to save your settings.

Send Scan to E-mail

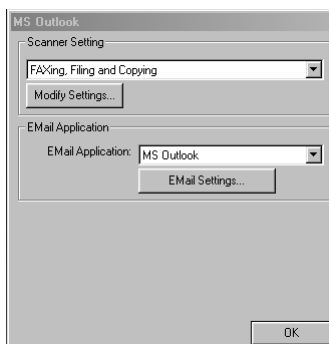

Scanner Settings

From the pull-down list, select the scanning mode that is appropriate for the type of file: Faxing (For MFC 7400C only), Filing and Copying; Text for OCR; Photos; Photos (High Quality); Photos (Quick Scan); Custom; Draft Copy or Fine Copy.

To change any of the settings for that mode, click the **Modify Settings...** button.

Email Application

Email Package—From the pull-down list, select your E-mail application.

Email Settings—Click the **Email Settings...** button to set up links.

The Links Preferences window will appear:

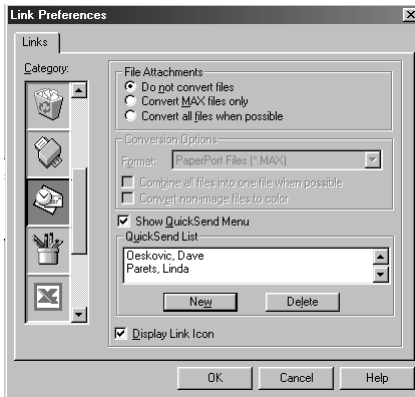

File Attachments

Do not convert files—Click this checkbox if you do not want to change the file type of attachments. The Conversion Options will not be available (grayed).

Convert MAX files only—Click this checkbox if you want to convert only attachments that are PaperPort files.

Convert all files when possible—Click this checkbox if you want to change the file type of all attachments.

Conversion Options

Format

Combine all files into one file when possible—Click this checkbox to combine all files of the same type into one file.

(For Brother Color Models Only) *Convert non-image files to color*—Click this checkbox to convert all files that have been processed through OCR to color.

Show QuickSend Menu

Click this checkbox if you want the Select QuickSend Recipient window to be displayed when you choose Scan to E-mail. This feature works only with MAPI type E-mail applications, such as Microsoft Exchange, Microsoft Outlook and Eudora.

QuickSend List

You can create a list of Email names and addresses for quick selection.

Click the **New** button to add a name(s) to your QuickSend list. Your Email phone book listing is displayed, so you can select stored names or create new ones:

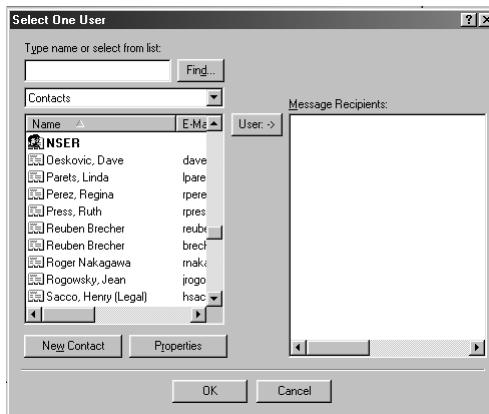

Highlight the name(s) you want to add to your list, click the **User** button, then click **OK** to return to the Link Preference window.

From the Link Preference window, you can remove a name from the QuickSend list, highlight the name and clicking the **Delete** button.

Send Scan to Word Processor



Scanner Settings

From the pull-down list, select the scanning mode that is appropriate for the type of file: Faxing (For MFC 7400C only), Filing and Copying; Text for OCR; Photos; Photos (High Quality); Photos (Quick Scan); Custom; Draft Copy or Fine Copy.

To change any of the settings for that mode, click the **Modify Settings...** button.

Word Processor

Word Processor—From the pull-down list, select the word processor you want to use.

Click the **Link Settings...** button to display a screen to set up a link to the version of OCR and document format that you want to use:



OCR Package—From the pull-down list, select *TextBridge Classic OCR* if you want to use the OCR package that was installed with the Brother software.

Click the **OCR Settings...** button to choose how the OCR application will read the pages you scan into your word processor application.

The Preferences window will appear:



Select your setting and click **OK**.

- *Auto Orientation*—Check this checkbox if you want your word processor application to read the page as it is set up.
- *Decolumnized Output*—Check this checkbox if you want your word processor application to read across the entire page from left to right.
- *Document Format*—From the pull-down list, select the file format you want to use for your word processor or text documents.

User Defined Button

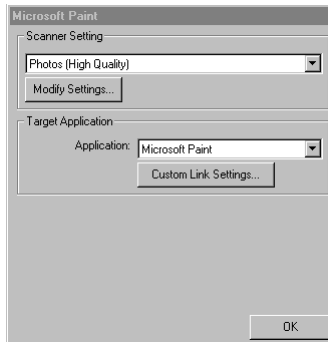

Scanner Settings

From the pull-down list, select the scanning mode that is appropriate for the type of file: Faxing (For MFC 7400C only), Filing and Copying; Text for OCR; Photos; Photos (High Quality); Photos (Quick Scan); Custom; Draft Copy or Fine Copy.

To change any of the settings for that mode, click the **Modify Settings...** button.

Target Application

Application—From the pull-down list, select the application you want to add to this Pop-Up screen.

Click the **Custom Link Settings...** button to set up links for your user-defined application.

Copy/Two on One Copy

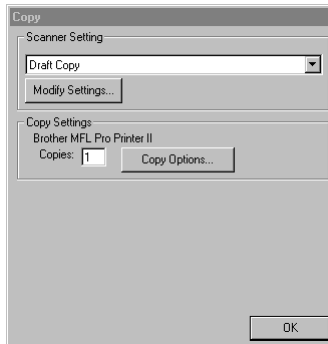

Scanner Settings

From the pull-down list, select the scanning mode that is appropriate for the type of file: Faxing (For MFC 7400C only), Filing and Copying; Text for OCR; Photos; Photos (High Quality); Photos (Quick Scan); Custom; Draft Copy or Fine Copy.

To change any of the settings for that mode, click the **Modify Settings...** button.

Copy Settings

Brother MFC7300C/MFC7400C

Copies—Enter the number of copies you want to print.

To change the copy options, click the **Copy Options...** button.

Click the **OK** button to save your Copy settings.

Send a Fax (For MFC 7400C only)

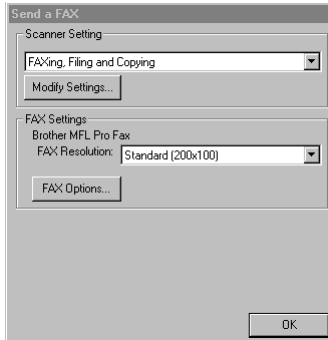

Scanner Settings

From the pull-down list, select the scanning mode that is appropriate for the type of file: Faxing (For MFC 7400C only), Filing and Copying; Text for OCR; Photos; Photos (High Quality); Photos (Quick Scan); Custom; Draft Copy or Fine Copy.

To change any of the settings for that mode, click the **Modify Settings...** button.

FAX Settings

Brother MFL Pro Fax

FAX Resolution—Click the pull-down arrow to choose the fax resolution you want:

- Standard (200x100)
- Fine (200x200)
- SuperFine (200x400)

To change the fax options, click the **FAX Options...** button.

Click the **OK** button when you are ready to save your FAX settings.

The MFL Pro Fax on COM1 Properties screen appears:

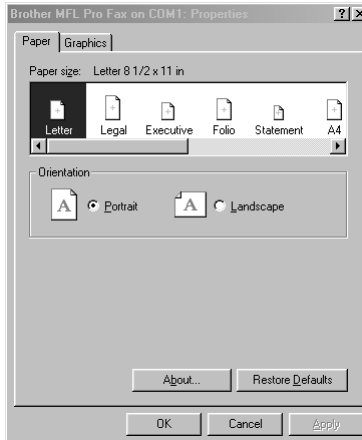

Select the *Paper Size*, *Orientation* (Portrait or Landscape) and click **OK**.

To return to the factory default settings, click the **Restore Defaults** button.

18 Using ScanSoft™ PaperPort® for Brother/TextBridge®

Using ScanSoft™ PaperPort® and TextBridge®

ScanSoft™ PaperPort® for Brother is a document management application. You will use PaperPort® to view incoming faxes (for MFC 7400C only) and scanned documents. PaperPort® has a sophisticated, yet easy-to-use, filing system that will help you organize your graphics and text documents. It allows you to combine or “stack” documents of different formats for printing, faxing (for MFC 7400C only) or filing. ScanSoft™ PaperPort® can be accessed through the ScanSoft™ PaperPort® program group. See *On-Line Documentation for Multi-Function Link® Pro* on the CD-ROM.

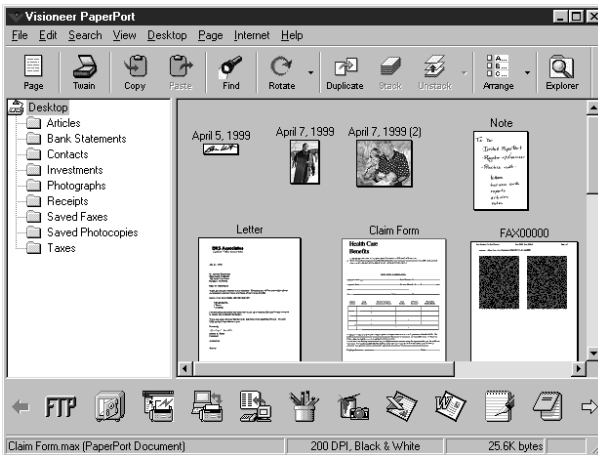

The complete ScanSoft™ PaperPort® Owner’s Manual, including ScanSoft™ TextBridge® OCR, is in the On-Line Documentation on the CD-ROM. This chapter is only an introduction to the basic operations.

Viewing Items in ScanSoft™ PaperPort™

ScanSoft™ PaperPort® provides several ways to view items:

Desktop View displays a **thumbnail**, a small graphic that represents each item in a Desktop or folder. Items in the selected folder appear on the PaperPort® Desktop. You can see PaperPort® items (MAX files) and non-PaperPort® items (files created using other applications). Non-PaperPort® items include an icon that indicates the application that was used to create the item; a non-PaperPort® item is represented by a small rectangular thumbnail and not an actual image.

Page View displays a close-up of a single page and you can open a PaperPort® item by double-clicking on it. As long as you have the appropriate application on your computer to display it, you can also double-click a non-PaperPort® item to open it.

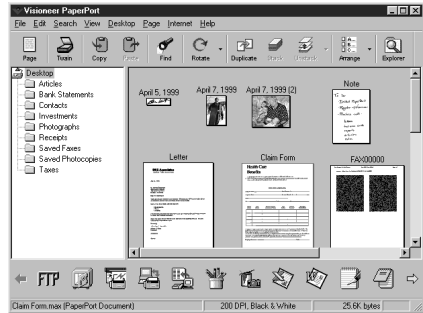

Desktop View displays items as thumbnails

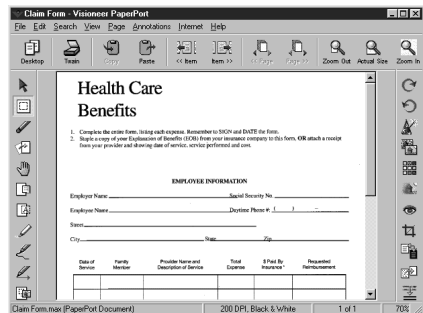

Page View displays each item as a full page

Organizing Your Items in Folders

PaperPort® has an easy-to-use filing system for organizing your items. The filing system consists of folders and items that you select to view in Desktop View. An item can be a PaperPort® item or a non-PaperPort® item:

- Folders are arranged in a “tree” structure in the Folder View. You use this pane to select folders and view their items in Desktop View.
- You can simply drag and drop an item onto a folder. When the folder is highlighted, release the mouse button and the item is stored in that folder.
- Folders can be “nested”—that is, stored in other folders.
- When you double-click a folder, its items (both PaperPort® MAX files and other files) appear on the Desktop.
- You can also use Windows® Explorer to manage the folders and items shown in Desktop View.

Links to Many Other Applications

ScanSoft™ PaperPort® automatically recognizes many other applications on your computer and creates a “working link” to them. The Link Bar at the bottom of Desktop view shows icons of those linked applications. To use a link, drag an item onto one of the icons to start the application represented by the icon. A typical use of the Link Bar is to select an item and then fax it.

This sample Link Bar shows several applications with links to PaperPort®.



If PaperPort® does not automatically recognize one of the applications on your computer, you can manually create a link using the **Create New Link** command. (See *PaperPort®* in the On-Line-Documentation on the CD-ROM for more information about creating new links.)

Using ScanSoft™ TextBridge® OCR (Converting Image Text to Text You Can Edit)

Software by:  ScanSoft™

ScanSoft™ TextBridge® OCR is automatically installed when you install ScanSoft™ PaperPort® on your computer.

ScanSoft™ PaperPort® can quickly convert the text on a ScanSoft™ PaperPort® item (which is really just a picture of the text) into text that you can edit with a word processing application. PaperPort® uses the optical character recognition application ScanSoft™ TextBridge®, which comes with PaperPort®—**OR**—PaperPort® uses your application if it is already on your computer. You can convert the entire item, or by using the **Copy As Text** command, you can select only a portion of the text to convert.

Dragging an item onto a word-processing link icon starts PaperPort®’s built-in OCR application, or you can use your own OCR application.



Importing Items from Other Applications

In addition to scanning items, you can bring items into PaperPort® in a variety of ways and convert them to PaperPort® (MAX) files in several different ways:

- Print to the Desktop View from another application, such as Microsoft Excel.
- Import files saved in other file formats, such as Windows® Bitmap (BMP) or Tag Image File Format (TIFF).

Exporting Items in Other Formats

You can export or save PaperPort® items in several popular file formats, such as BMP, JPEG, TIFF, or self-viewing. For example, to create a file for an Internet Web site, export it as a JPEG file. Web pages often use JPEG files for displaying images.

Scanning a Document

TWAIN COMPLIANT

The Brother Multi-Function Link® Pro software includes a TWAIN compliant scanner driver. TWAIN drivers meet the standard universal protocol for communicating between scanners and software applications. This means that not only can you scan images directly into the PaperPort® viewer that Brother included with your MFC, but you can also scan images directly into hundreds of other software applications that support TWAIN scanning. These applications include popular programs like Adobe Photoshop, Adobe PageMaker, CorelDraw and many more.

To choose Brother Multi-Function Link® Pro as your scanner driver, select it under the Select scanner—**OR**—Select source option in your software.

Accessing the Scanner

From the PaperPort® window, select the **Scan** or **TWAIN** button or from the File drop-down menu choose **Acquire**. Multi-Function Link® Pro's TWAIN dialog box will appear:

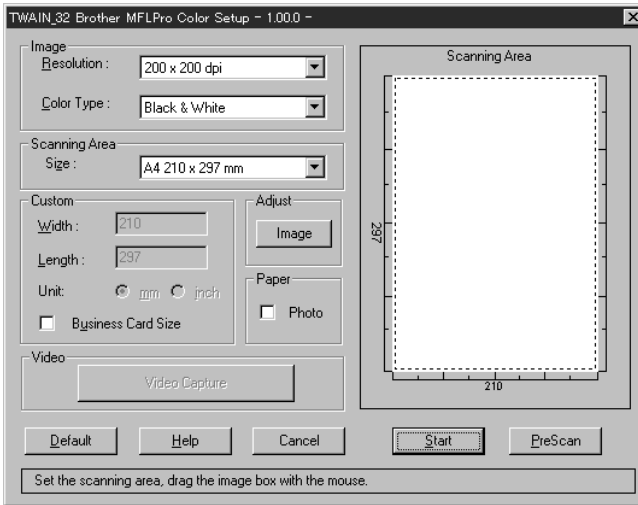

Scanning a Document into the PC

- 1 Place the original face down in the ADF.
- 2 Adjust the following settings, if needed, in the Scanner window:
 - *Resolution*
 - *Color Type* (Black & White, Gray [Error Diffusion], True Gray, 256 Color or 24-bit color)
 - *Size*
- 3 Select the **Start** button from the scanner window.

When scanning is completed, press **Cancel** to return to the PaperPort® window.

Settings in the Scanner Window

Resolution:

Resolution: Select the scanning resolution from the Resolution drop down list. Higher resolutions take more memory and transfer time, but can achieve a finer scanned image. You can choose:

- 100 x 100 dpi
- 150 x 150 dpi
- 200 x 100 dpi (Black & White, Gray [Error Diffusion] only)
- 200 x 200 dpi
- 200 x 400 dpi (Black & White, Gray [Error Diffusion] only)
- 300 x 300 dpi
- 400 x 400 dpi
- 600 x 600 dpi
- 1200 x 1200 dpi (Black & white, Gray [Error Diffusion]. True Gray and 24-bit color only)
- 2400 x 2400 dpi (Black & white, Gray [Error Diffusion]. True Gray and 24-bit color only)

Color Type:

Black & White: Set the Color Type to Black & White for text or line art.

Gray Scale: For photographic images, set the Color Type to Gray (Error Diffusion) or True Gray.

Colors: Choose either 256 Color, which scans up to 256 colors, 24-bit color which scans up to 16.8 million colors. Although using 24-bit color creates an image with the most accurate colors, the image file will be approximately nine times larger than a file created with 256 Color.

Size:

Set the Size to one of the following:

- Letter (8 1/2 x 11 in.)
- A4 (210 x 297 mm.)
- Legal (8 1/2 x 14 in.)
- A5 (148 x 210 mm.)
- B5 (182 x 257 mm.)
- Executive (7 1/4 x 10 1/2 in.)
- Business Card (90 x 60 mm.)
- Custom (User adjustable from 0.35 x 0.35 in. to 8.5 x 14 in.)

After you select a custom size, you can adjust the scanning area further by using the left mouse button to drag the dotted outline of the scanning area. This is required when you want to crop an image when scanning.

To scan business cards, select the Business Card (90 x 60 mm.) size setting and place the business card at the top center of a carrier sheet.

Carrier sheets are available from your Dealer.

When scanning photographs or other images for use in a word processor or other graphics application, you should try different settings for the contrast, mode and resolution to see which settings best suit your needs.

Custom:

This section displays the size you selected. To adjust the scanning area size to business card size automatically, check the Business Card Size box.

Adjust:

In the Adjust section, click the **Image** button. The Image screen will appear:

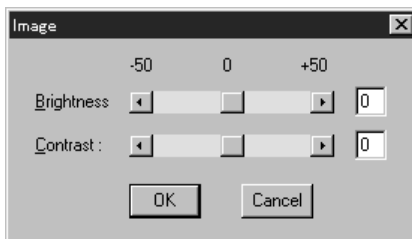

Use the cursor to drag the indicator buttons to the left or right to adjust the Brightness and the Contrast, as needed.

Paper:

Check the Photo box if the image is a photograph.

Video Capture:

The Video Capture button displays the video frame grabber window.
(See *Video Capture from the PC*, page 18-10 for details.)

PreScanning an Image

PreScanning allows you to scan an image quickly at a low resolution. A thumbnail version of the image will appear in the Scanning Area. This is only a preview of the image so you can see how it will look. The PreScan button is used to preview an image for cropping any unwanted portions from the image. When you are satisfied with the preview, select the **Start** button from the scanner window to scan the image.

How to use PreScan to adjust an image:

- 1 Insert the original face down in the ADF.
- 2 Select the **PreScan** button.
The entire original will be scanned into the PC and will appear in the Scanning Area of the Scanner window.

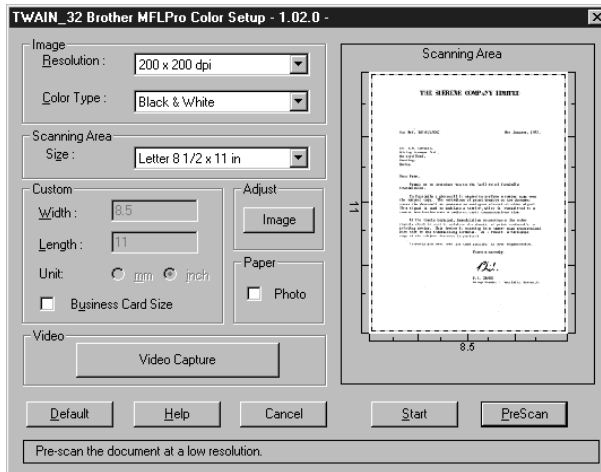

- 3 To crop a portion of the original to be scanned, drag any side or corner of the dotted outline in the Scanning Area with the left mouse button. Adjust the dotted outline until it surrounds only the portion of the original you wish to scan.
- 4 Place the original face down in the ADF.
- 5 Adjust the settings for Resolution, Color Type and Size in the Scanner window, as needed.

- 6 Select the **Start** button.
This time only the selected area of the original will appear in the PaperPort® window.

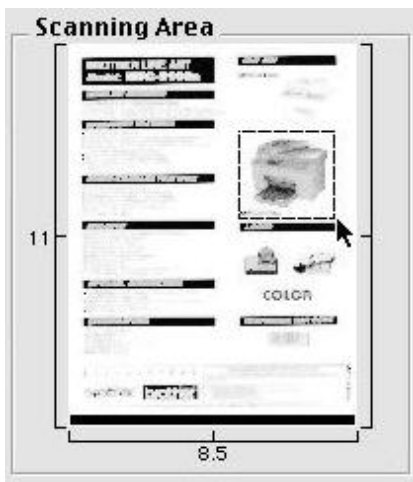

- 7 In the PaperPort® window, use the options available to refine the image. (See PaperPort® for Brother Online Documentation on the CD-ROM for details.)

Video Capture from the PC

Video Capture is the process of isolating a single frame (or picture) from media played on video equipment (such as a video camera or VCR) and then converting that frame into an image file on your PC. Once the frame is an image file, it can be saved, printed, faxed, and inserted into other files.

Connecting Your Video Equipment

Before you can begin to capture a video frame, you must first connect your video equipment to the MFC.

To connect your video equipment:

- 1 Connect your video cable to the jack on your video equipment labeled **VIDEO OUT**.
- 2 Connect the RCA male plug on the other end of the video cable to the RCA female jack on the front of the MFC.

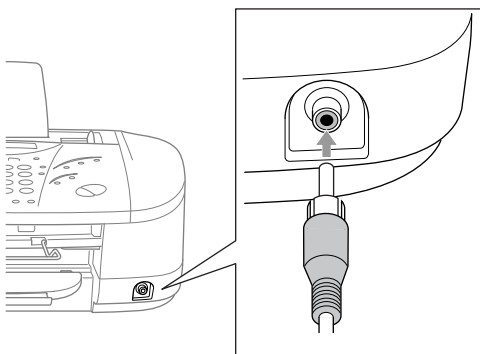

Capturing An Image

You can access Multi-Function Link® Pro's TWAIN dialog box from the ScanSoft™ PaperPort® for Brother viewer or from any application that is compatible with TWAIN scanning devices.

! Caution

It is important that you hook up your MFC to your computer *before* you install the software.

To capture a frame as an image:

- 1 Connect your video equipment to the MFC.
- 2 From PaperPort®, select **Acquire** from the **File** menu, or click on the

Scan (TWAIN)  icon.

Multi-Function Link® Pro's TWAIN dialog box will appear:

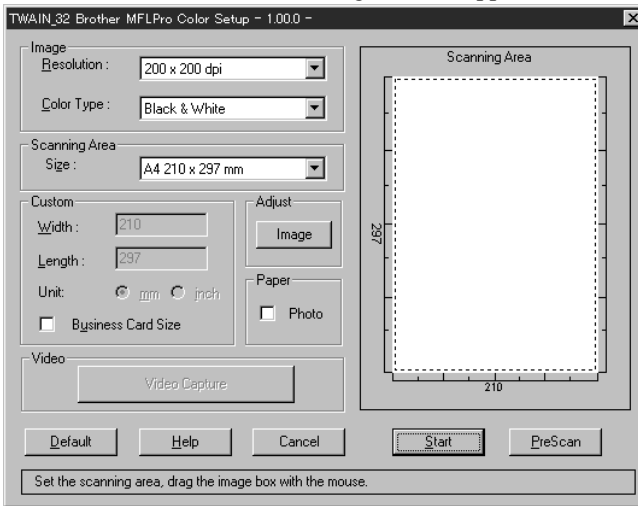

- 3 In the Multi-Function Link® Pro Setup (TWAIN) dialog box, click the **Video Capture** button.
The Video Capture dialog box will appear.



- 4 Select the **Source** of the video:
 - Live Camera
 - Tape/VCR
 - Laser Disc®
 - Digital Camera
- 5 Select the **Type** of video:
 - Auto-is the most common choice, since the system will determine the Type for you.
 - Moving
 - Still
 - High Quality
 - Pro Quality-is the highest quality.
- 6 Select the **Preview** type:
 - B & W-Black and White displays approximately four frames per second.
 - Color-displays approximately one frame every two seconds because color images contain much more data.
- 7 Select the **Size** (dots per inch) of the image file to be created:
 - 1280 x 960-is the best quality. The image file will be large and take more space on your PC.
 - 750 x 562
 - 640 x 480-is suitable for most images.
 - 320 x 240
- 8 Turn on your video equipment and start running the video.
- 9 When you see the frame you want to capture, click the **Pause** button. The frame will be displayed in the viewer screen section of Multi-Function Link® Pro's TWAIN dialog box.
- 10 If you wish to capture the displayed frame, click the **OK** button—**OR**—
If you are not satisfied with the frame that is displayed, resume running the video by clicking the **Pause** button a second time.
The video will resume running.
- 11 Click the **Quit** button to exit the Video Capture dialog box.
- 12 Run PaperPort®, where a thumbnail image of your frame will be displayed. (See ScanSoft™ PaperPort® Online Documentation on the CD-ROM for details).

19 Using Multi-Function Link® Pro Software

Introduction

This chapter outlines the basics of the Brother software, so you can get started using the Multi-Function Link® Pro software. Detailed installation and setup instructions are in the On-Line Documentation section of the Brother CD-ROM that is included with your MFC.

Check the online **README.WRI** file in the root directory of the CD-ROM for last-minute important information and troubleshooting tips that were not included in the On-Line Documentation.

Multi-Function Link® Pro software for your MFC includes ScanSoft™ PaperPort® for Brother and ScanSoft™ TextBridge®. (See Chapter 18, *Using ScanSoft™ PaperPort® for Brother/TextBridge®*.)

Software by: **SMITHMICRO**
SOFTWARE 

Brother Resource Manager

The Brother Resource Manager application must be running for you to use your MFC with your Windows® computer. Multi-Function Link® Pro software and the MFL Pro Printer Driver automatically load the Resource Manager, as needed. The Resource Manager allows the single bi-directional Parallel port on the MFC to simulate a Communications port for faxing and scanning and to simulate a Parallel port for Windows® GDI printing.

MFC Remote Setup

The MFC Remote Setup application allows you to quickly set up your MFC by taking advantage of the ease and speed of programming on your PC. When you access this application, the settings on your MFC will be downloaded automatically to your PC and displayed on your computer screen. If you change the settings, you can upload them directly to the MFC.

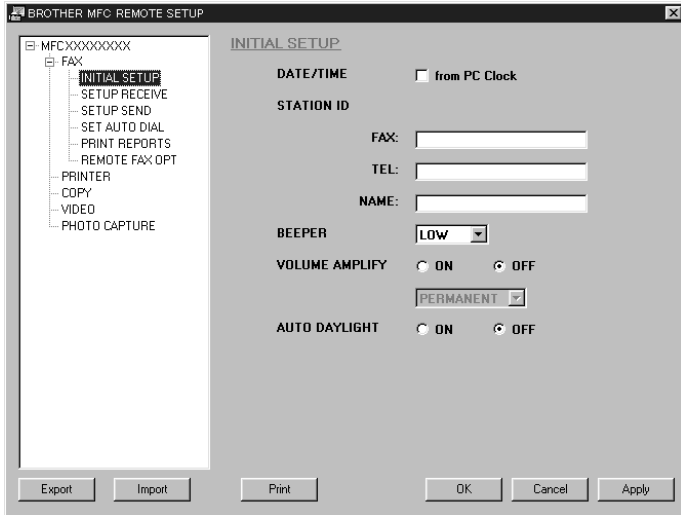

OK

This starts the process of uploading the data to the MFC and exiting the remote setup program. If an error message is displayed enter the correct data again, then click **OK**.

CANCEL

This exits the remote setup application without uploading the data to the MFC.

APPLY

This uploads the data to the MFC, but does not exit the remote setup application.

PRINT

This command prints the selected items on the MFC. You can not print the data until it is uploaded to the MFC. Click **APPLY** to upload the new data to the MFC and click **PRINT**.

EXPORT

This command saves the current configuration settings to a file.

IMPORT

This command reads the settings from a file.

Multi-Function Link® Pro Main Menu (For MFC 7400C only)

The Multi-Function Link® Pro Main Menu is the application used for all fax sending and receiving operations. It also contains an electronic Phone Book program and a Log Manager that maintains a record of all PC fax transactions. The Main Menu can be accessed through the Brother

Multi-Function Link® Pro program group.

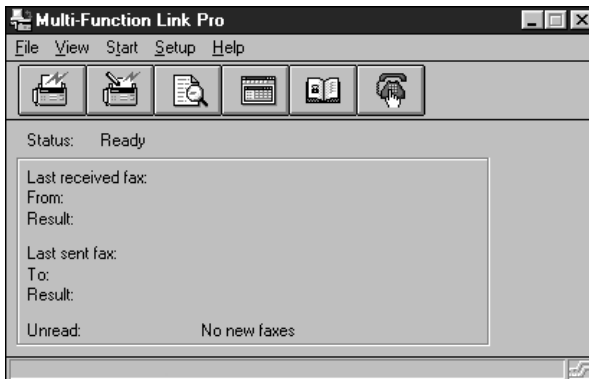

Sending a Fax from Your PC (For MFC 7400C only)

Sending a Quick Fax

A QuickFax is a cover page only fax with a message. This option is very useful when you want to fax a quick, short message from your PC.

- 1 From the Main Menu, select the QuickFax  button—**OR**—Select QuickFax from the Start pull-down menu. The QuickFax screen will appear.
- 2 Enter the Fax number, Name, and Company information in the appropriate fields on the screen—**OR**—Select the Open Phone Book... button to choose someone from your phone book.
- 3 Complete the Subject and QuickFax note fields.
- 4 Click the Send Fax button.

Sending a Fax from the Main Menu

You can send a fax from the Main Menu and attach multiple files. The “attachments” can be in different file formats.

- 1 From the Main Menu window, select the Send Fax  button—**OR**—Select Send Fax from the Start pull-down menu. The Send Fax window will appear:

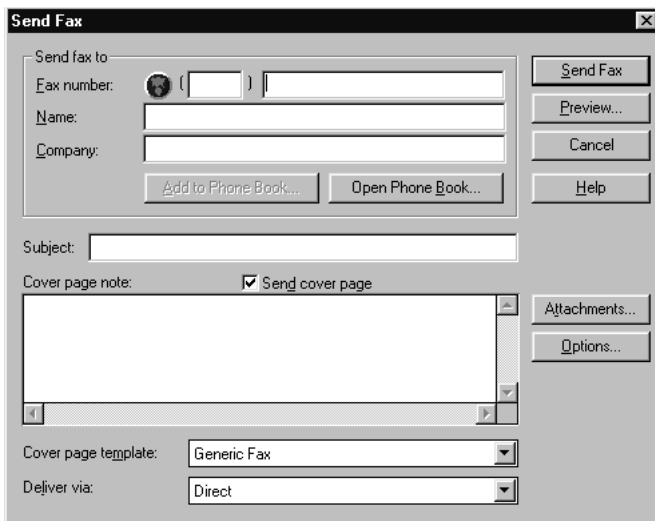

- 2 Enter the Fax number, Name, and Company information in these fields —**OR**—Select the Open Phone Book button to choose someone from your phone book.
- 3 Complete the Subject and Cover page note fields.
- 4 Click on the **Attachments...** button to add any file(s) you want to fax with it.
- 5 Click the **Send Fax** button.

Sending a Fax from a Windows® Application

You can send a fax directly from any Windows® application using the following steps:

- 1 Create the document in a Windows® application.
- 2 Select **Brother MFL Pro Fax** as your printer.
- 3 Select the Print command to begin the fax transmission. The Fax Sending dialog box will appear:
- 4 Enter the name and fax number of the recipient—**OR**—Select the Open Phone Book... button and choose a name. Select Close to return to the Send Fax dialog box.
- 5 Select the Send cover page check box to include a cover page.
- 6 Select the Send Fax button.

Receiving Faxes into the PC (For MFC 7400C only)

To receive faxes into your PC through the MFC, first you must have connected your MFC to your computer. Then, you can load the Multi-Function Link® Pro software. (See *Setting Up the MFC and PC to Work Together*, page 14-1.)

Use the following checklists for the MFC and PC, to make sure you have properly set up the MFC and PC to work together.

Checklist for Your PC

- 1 Make sure the MFC is connected to the PC.
- 2 In the Main Menu, select the Setup pull-down menu.
- 3 Select Preferences...
- 4 Under Answer Mode, select Fax only.
- 5 Click the OK button.
- 6 Keep the PC and the Multi-Function Link® Pro Main Menu running at all times.

Viewing Received Faxes

Faxes that are received into the PC will appear in the InBox of the Log Manager. To access the Log Manager, from the Main Menu click the Log Manager



button—**OR**—From the Start pull-down menu, select Mail/Log.

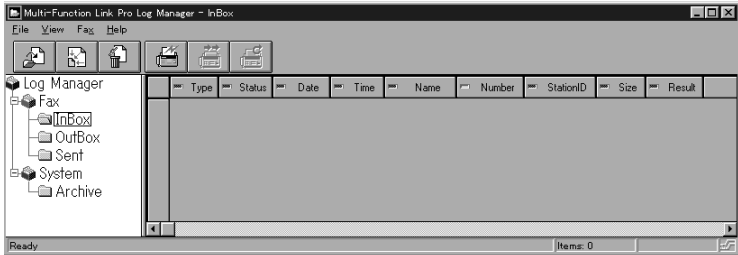

- 1 In the Log Manager, select the Fax folder.
- 2 Then select the InBox folder. A listing of your incoming messages will appear on the right side of the window.
- 3 Double-click on the fax you wish to view.
The ScanSoft™ PaperPort® Viewer will run automatically and the fax you selected from the list will be displayed. (See page 18-2.)

20 PhotoCapture Center™ (MFC 7400C only)

Introduction

The PhotoCapture Center™ Function is only available on your PC (Windows® 98, 98SE, ME and 2000 Professional) when you are using a USB cable to connect your MFC to the PC.

Double click the Removable Disk icon on your Windows explorer, and the files and folders are displayed on the SmartMedia™ or CompactFlash™ card which inserted to the MFC.

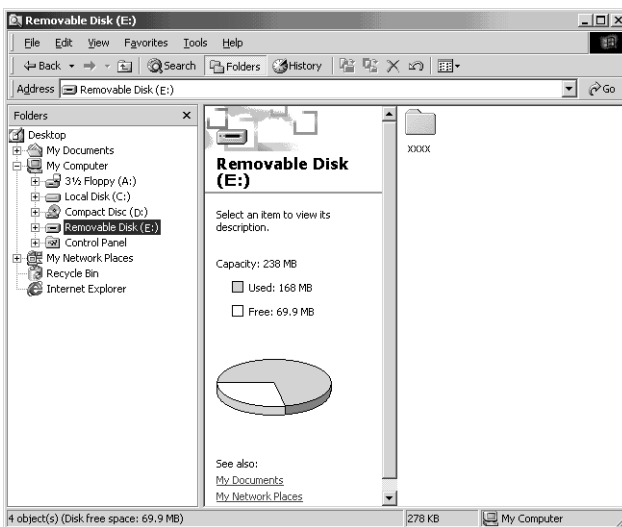

If both media cards are inserted at the same time, the PhotoCapture Center™ will only read the card that was installed first. To have access to the other card, you must first remove both cards, then insert only the media card you wish to access. When MFC is printing from the PhotoCapture Center™ function, the PC can not access the PhotoCapture Center™.

Do not remove a SmartMedia™ or CompactFlash™ card from the MFC while the MFC is reading the card (LED is flashing). You can lose data or damage the card.

PhotoPrinter 2000 Pro

PhotoPrinter 2000 Pro program is a versatile printing utility that lets you quickly print multiple copies of an image or several different images on a single sheet of paper.

The program automatically pops up when inserting the media card in the PhotoCapture Center™. You can then create thumbnails, copy pictures and pictures and print the images from the media card.

Overview of Basic Steps

- 1 Insert the memory card (Compact Flash or Smart Media Card) into the appropriate slot on your MFC.
- 2 The Brother PhotoCapture Manager will launch the PhotoPrinter software once it detected the insertion of the memory card.
- 3 PhotoPrinter automatically starts up in the “*Get Photo/Album*” user interface with a custom designed Brother “*PhotoCapture Center*™” add photo dialog opened displaying the contents of the PhotoCapture Center™ drive.



This PhotoCapture Center™ “*custom add photo*” dialog enables the user to create an album with the contents of the drive, and provides the option to copy photos from the PhotoCapture Center™ to the host computer.

Custom Add Photo Screen: PhotoCapture Center™



- 4 Click “*removable drive*”. You are going to be prompted to enter a New Album, or select an existing album name.
- 5 Click “*Open*” to generate thumbnails for all images in all directories.
- 6 Click on the individual images to create thumbnails for only the selected images.
- 7 Click “*Automatically Create album and do not show this selection menu*” to add all contents of the removable media drive to the specified album every time the media card is inserted.



Click “*Get Photo*” for manually opening the “*PhotoCapture Add*” dialog. Selecting this button will automatically launch the PhotoCapture Center dialog. Use identical style to blend with the existing buttons.

Settings in the PhotoCapture Center™ Dialog

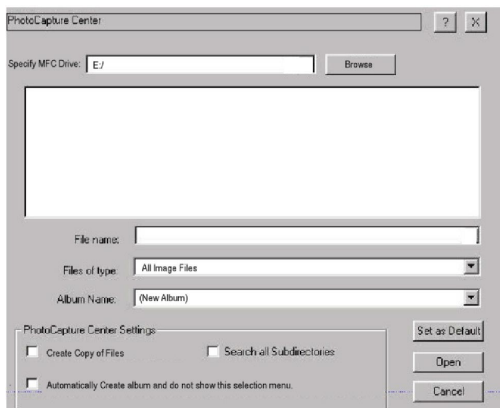

Specify MFC Drive-----Defaults to the last drive/root directory and displays only “*removable drives*”, not a full drive list.

File Name-----Displays the selected file as in the standard “*Add photo*” dialog.

Files of Type-----Defaults to “*All Image files*” and functions as per the standard “*Add Photo*” dialog.

Album Name-----Defaults to “*New Album*”. Provides a pull-down menu of existing albums to select. If the user does not enter an album name, the software will automatically create an “*untitled-1*” as per normal “*Get Photo*” function. The user can also type in a new album name.

Automatically Create album do not show this selection menu-----When box is checked, this screen is automatically bypassed when the next media is inserted and PhotoPrinter is launched by the PhotoCapture Manager run. The creation of thumbnails and the optional copy of files will run as specified in the default setting.

Search all Subdirectories-----When checked, it should search all subdirectories on the selected drive and retrieve all selected image file types.

Copy Files-----When checked, all selected files are automatically copied to the PhotoPrinter Pro 2000/photos directory.

Set as Default-----Will save settings automatically to use the same settings each time the PhotoCapture Manager launches PhotoPrinter.

21 Using Automatic E-Mail Printing

For Windows® 95/98/98SE, ME only

Main Features

- You can use Automatic E-Mail Printing with other E-mail software: Brother Automatic E-Mail Printing has some extra functions that other E-mail software, such as Netscape Navigator™ or MS Internet Mail, do not support.
- Automatic E-Mail Printing can be configured for a multiple user account: In Brother Automatic E-Mail Printing you can set up more than one e-mail account on a single PC so you can print e-mail in each account automatically.
- Automatic access to your specified POP3 server at the specified time: You can specify the time when the Brother Automatic E-Mail Printing automatically accesses the server to check for new mail.
- Provides an “In Memory” printer driver: You can receive and print e-mail data at the same time, by searching for a specified character string in the mail header. It allows you to see the sender, subject and relevant part of the mail content.

Before You Use this Software

Please read *Using Automatic E-Mail Printing* in the **On-Line Documentation** on the CD-ROM. Check the online README.WRI file in the root directory of the CD-ROM for last-minute important information and troubleshooting tips not included in the On-Line Documentation. Look for updates at www.brother.com, which will be listed under your model number.



To Access the On-Line Documentation

After you have installed the Brother driver(s) for your model and operating system, click **View On-Line Documentation** for operation instructions.

22 Using the Brother MFC with a New Power Macintosh® G3, G4 or iMac™/iBook

Set up Your USB Equipped Apple® Macintosh® G3, G4 or iMac™ with Mac OS 8.5/8.51/8.6/9.0

Note Before you can connect the MFC to your Macintosh®, you must purchase a USB cable that is no longer than 6 feet (1.8 meters).

Set up your USB Equipped Apple® Macintosh® with Mac OS 8.5/8.51/8.6/9.0 for your MFC: (For Scanner driver works with Mac OS 8.6/9.0)

Notice to Computer Users

A small filter core and cable tie are enclosed in a vinyl bag with your MFC. **PLEASE SAVE THESE PARTS.** You will need them in the future if you connect the MFC to a Computer. For optimal performance, use a USB Cable with the enclosed Filter Core and Cable Tie.

When you use a Macintosh® with your MFC, please attach the enclosed Filter Core to a USB Cable.

- 1 Attach the Cable Tie 2 inches or less from the end of the USB Cable that will be inserted into the MFC.
- 2 Attach the filter core between the USB Cable Connector and the Cable Tie by pressing until you hear a click.

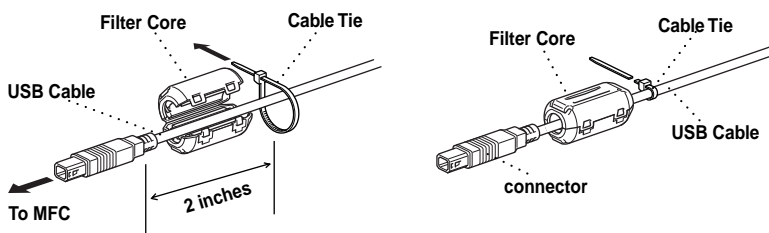

Set up your MFC and make sure that it is working properly.

Installing the Brother Printer and Scanner Drivers

- 1 Turn on the power to your Macintosh and wait for the startup process to be completed.
- 2 Insert the Brother CD-ROM into your CD-ROM drive. The window below will appear automatically.
- 3 To install the printer and scanner drivers, click **MFL Pro Driver Installer**.
- 4 After installation is completed, connect a standard USB cable to both the MFC and the Macintosh.

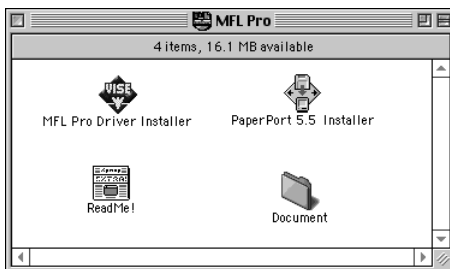

Restart your Macintosh so it can recognize the new drivers.

Installing PaperPort®

PaperPort is a document management application used to view scanned documents.

1. Insert the Brother CD-ROM.
2. Click the **PaperPort® 5.5 Installer**.
3. Follow the instructions.

Using Brother Printer driver with your Apple® Macintosh®

To select the Printer:

- 1 From the Apple menu, open the **Chooser**.

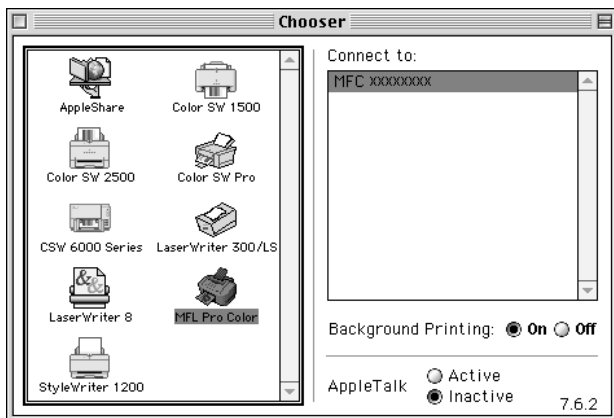

- 2 Click the printer driver you installed to highlight it. On the right side of the Chooser, click the printer to which you want to print. Close the Chooser.

To print the document:

- 3 From application software such as PaperPort®, click “**File menu**” and select “**Page Setup**”. You can change the settings for **Paper**, **Paper Thickness**, **Paper Source**, **Orientation**, and **Scale**, then click **OK**.

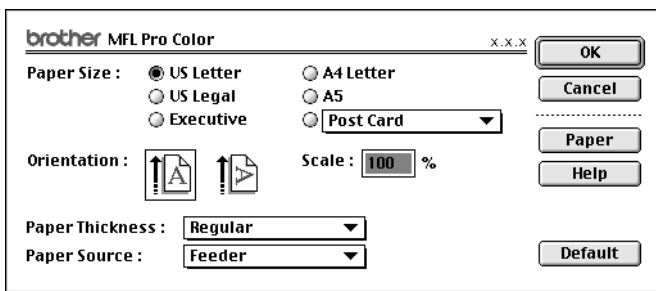

- 4 From application software such as PaperPort, click “**File menu**” and select “**Print**”. Click “**Print**” to start printing.

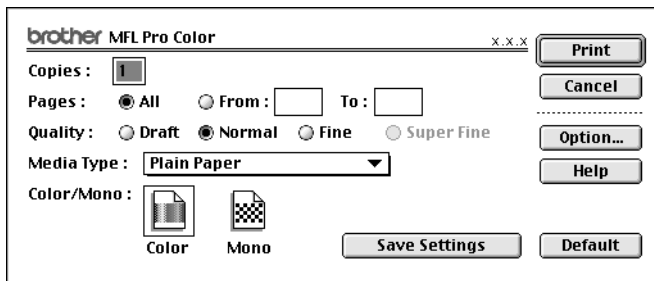

Note If you want to change **Copies**, **Pages**, **Quality**, **Media Type** and **Color/Mono**, select your settings before clicking **Print**.
Set **Option** allows you to change **Document** and **Printing Options**.

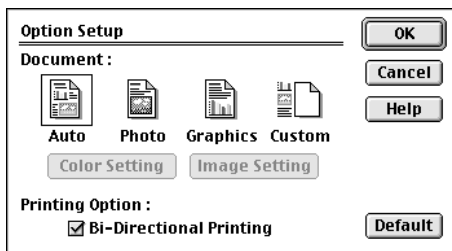

Using Brother TWAIN Scanner Driver with Your Apple® Macintosh®

The Brother MFC software includes a TWAIN Scanner driver for Macintosh®. This Macintosh® TWAIN Scanner driver can be used with application that supports the TWAIN specification. You can use PaperPort for scanning.

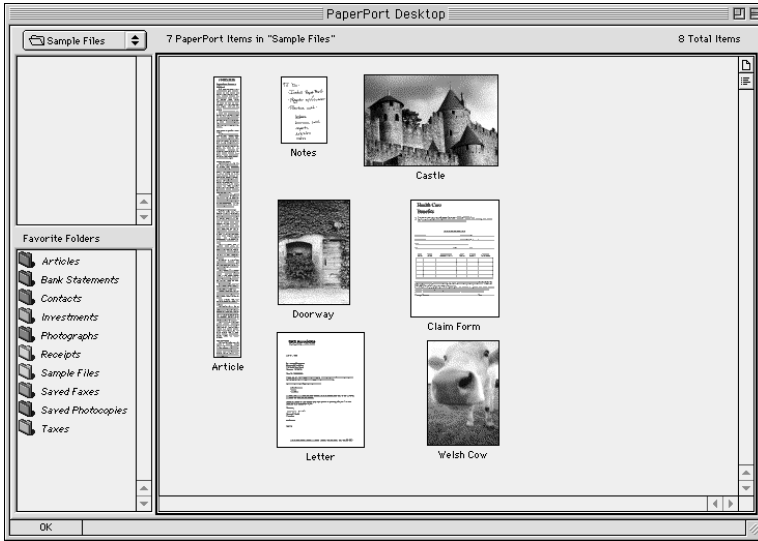

Accessing the Scanner

Run your PaperPort® software. You will see the PaperPort® icon in the upper right hand corner of your screen. The first time you use the Brother TWAIN driver, set it as the default by choosing the “**Select Source**”, then click the **PaperPort** icon. Afterward, for each original you scan choose “**Acquire Image**” by clicking the **PaperPort** icon. The Scanner setup dialog box will appear.

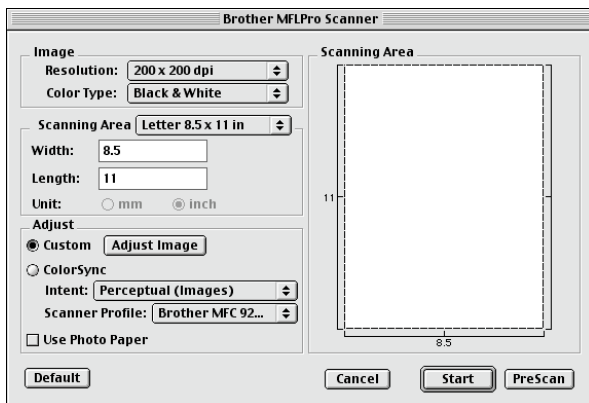

Scanning a Document into Your Macintosh G3, G4 or iMac

- 1 Place the original in the ADF.
- 2 Adjust the following settings, if needed, in the scanner setup dialog box:
 - Resolution*
 - Color Type*
 - Brightness*
 - Contrast*
 - Scanning Area*

- 3 Click **Start**.

When scanning is finished, the image will appear in your graphics application.

Settings in the Scanner Window

Image

Resolution

Choose the scanning resolution from the Resolution pop-up menu. Higher resolutions take more memory and transfer time, but can achieve a finer scanned image. (Each model has different resolutions. See Specification.)

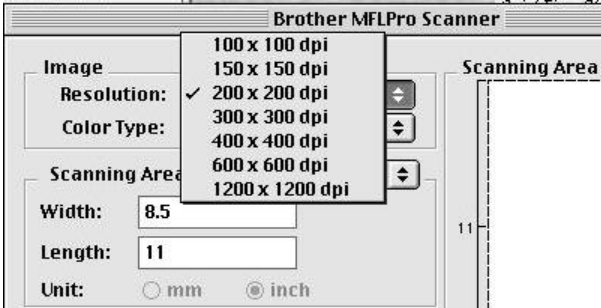

Color Type

Black & White—Set the image Type to Black&White for text or line art. For photographic images, set the image type to Gray (Error diffusion) or True Gray.

Gray (Error Diffusion)—is used for documents that contain photographic images or graphics. (Error Diffusion is a method for creating simulated gray images by placing black dots in a specific matrix instead of true gray dots.)

True Gray—also is used for documents containing photographic images or graphics. This mode is more exact because it uses up to 256 shades of gray. It requires the most memory and longest transfer time.

Colors—Choose either 8-bit, which scans up to 8-bit, 24-bit color, which scans up to 8-bit, 24-bit color, which scans up to 16.8 million colors. Although using 24-bit color creates an image with the most accurate colors, the image file will be approximately nine times larger than a file created with 8-bit. You have a choice of faster scanning with or using the Brother Color Matching Technology with 24-bit color.

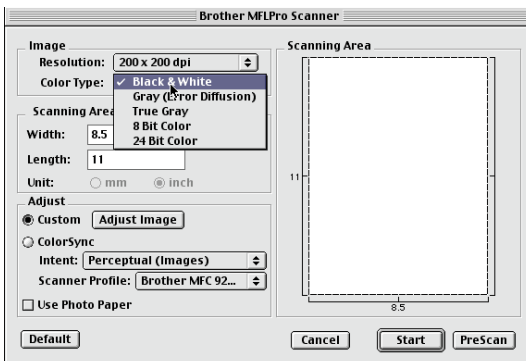

Scanning Area

Set the **Size** to one of the following:

- *Letter* (8.5 x 11 inches)
- *A4* (210 x 297 mm)
- *Legal* (8.5 x 14 inches)
- *A5* (148 x 210 mm)
- *B5* (182 x 257 mm)
- *Executive* (7.25 x 10.5 inches)
- *Business Card* (90 x 60 mm)
- *Custom* (User adjustable from 0.35 x 0.35 inches to 8.5 x 14 inches)

After you choose a custom size, you can adjust the scanning area. Click and hold the mouse button as you drag the mouse to crop the image.

Width: Enter the width of the custom size.

Length: Enter the length of the custom size.

Business Card Size

To scan business cards, select the Business Card size setting (90 x 60 mm) and place the business card at the top center of a carrier sheet.



Carrier sheets are available from your Dealer.

When scanning photographs or other images for use in a word processor or other graphics application, it is a good idea to try different settings for the contrast, mode and resolution to determine which settings look best.

Miscellaneous

Brightness

Adjust the brightness settings to obtain the best image. The Brother TWAIN Scanner driver offers 100 brightness settings (-50 to 50). The default value is 0, representing an “average” setting.

You can set the brightness level by dragging the slider to the right to lighten the image or to the left to darken the image. You can also type a value in the box to set the setting. Click **OK**.

If the scanned image is too light, set a lower brightness value and scan the document again.

If the image is too dark, set a higher brightness value and scan the document again.

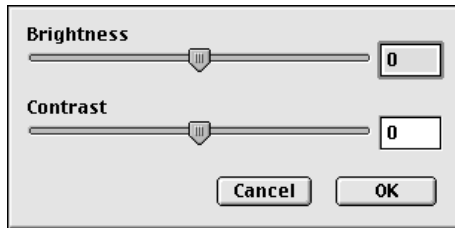

Contrast

The contrast setting is adjustable only when you have selected one of the gray scale settings, but it is not available when Black & White is selected as the Gray Scale.

Increasing the contrast level (by dragging the slider to the right) emphasizes dark and light areas of the Image, while decreasing the contrast level (by dragging the slider to the left) reveals more detail in gray areas. Instead of using the slider, you can type a value in the box to set the contrast. Click **OK**.

Color Sync Dialog

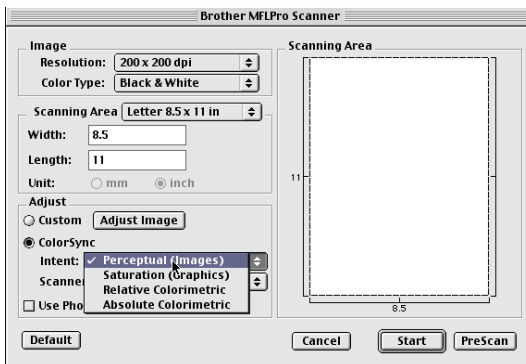

Perceptual Matching—All the colors of a given gamut are scaled proportionally to fit within another gamut. This intent pretty much maintain the balance between the colors in the image. This intent is the best choice for realistic images, such as scanned photographs.

Saturation Matching—The relative saturation of colors is maintained from gamut to gamut. So basically the colors are shifted to the edge of the gamut to get the most saturated color possible. Rendering the image using this intent gives the strongest colors and is the best choice for bar graphs and pie charts, in which the actual color displayed is less important than its vividness.

Relative Colorimetric Matching—The colors that fall within the gamuts of both devices are left unchanged. Some colors in both images will be exactly the same, a useful outcome when colors must match quantitatively. What that means is that if the color is inside the gamut, it will stay the same color. However, if the color is outside the gamut, it will be mapped to the edge of the gamut. This intent is best suited for logos or “spot colors” where color must match.

Absolute Colorimetric Matching—A close appearance match may be achieved over most of the tonal range, but if the minimum density of the idealized image is different from that of the output image, the areas of the image that are left blank will be different. Colors that fall within the gamuts of both devices are left unchanged.

Scanner Profile

Select your Brother MFC.

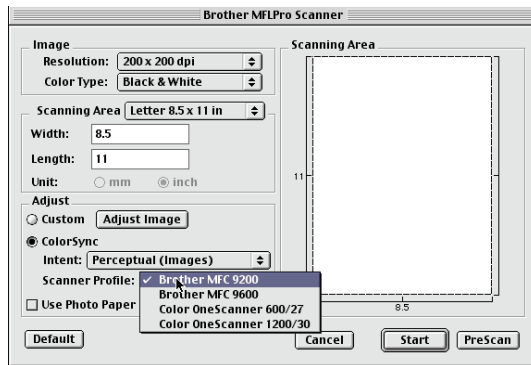

PreScanning an Image

PreScanning allows you to scan an image quickly at a low resolution. A thumbnail version will appear in the Scanning Area. This is only a preview of the image, so you can see how it will look. The PreScan button is used to preview an image for cropping any unwanted portions from the image. When you are satisfied with the preview, click Start to scan the image.

1 Insert the original face down in the ADF.

2 Click **PreScan**.

The entire original will be scanned into your Macintosh G3 or iMac and will appear in the Scanning Area of the Scanner dialog box:

3 To scan a portion of the prescanned image, click and drag the mouse to crop it.

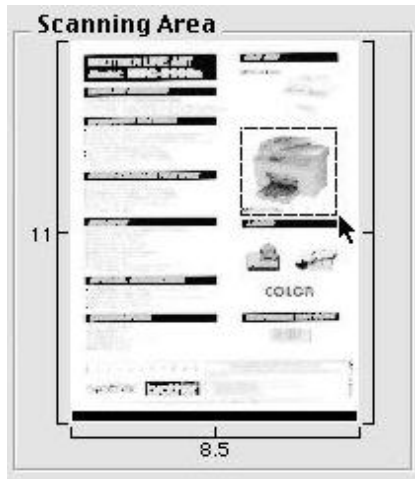

4 Insert original in the ADF of the Brother MFC again.

5 Adjust the settings for Resolution, Color Type (Gray Scale), Brightness, Contrast, and Size in the Scanner Setup dialog box, as needed.

6 Click **Start**.

This time only the selected area of the original will appear in the Scanning Area.

7 In your editing software application, refine the image as usual.

23 Important Information

Standard Telephone and FCC Notices

These notices are in effect on models sold and used in the United States only.

This equipment is hearing aid compatible.

When programming emergency numbers and/or making test calls to emergency numbers:

- Remain on the line and briefly explain to the dispatcher the reason for the call before hanging up.
- Perform these activities in the off-peak hours, such as early morning or late evening.

This equipment complies with Part 68 of FCC Rules. On the rear panel of this equipment is a label that contains, among other information, the FCC Registration Number and Ringer Equivalence Number (REN) for this equipment. You must, upon request, provide this information to your telephone company.

You may safely connect this equipment to the telephone line by means of a standard modular jack, USOC RJ11C.

An FCC compliant telephone cord with a modular plug is provided with this equipment. This equipment is designed to be connected to the telephone line or premises wiring using a compatible modular jack that is Part 68 compliant. See the Installation section of this manual for details.

The REN is useful to determine the quantity of devices you may connect to your telephone line and still have those devices ring when your telephone number is called. In most, but not all areas, the sum of the RENs of all devices connected to one line should not exceed five (5). To be certain of the number of devices you may connect to your line, as determined by the REN, you should contact your local telephone company to determine the maximum REN for your calling area. If your MFC 7300C or MFC 7400C damages the telephone line, the telephone company may discontinue your service temporarily. If possible, they will notify you in advance. But if advanced notice is not practical, you will be notified as soon as possible. You will be informed of your right to file a complaint with the FCC.

Your telephone company may make changes to its facilities, equipment, operations or procedures that could affect the proper functioning of your equipment. If they do, you will be notified in advance to give you an opportunity to maintain uninterrupted telephone service.

If you experience trouble with your MFC 7300C or MFC 7400C, please contact a Brother Authorized Service Center for information on obtaining service or repair. The telephone company may ask that you disconnect this equipment from the line until the problem has been corrected or until you are sure that the equipment is not malfunctioning.

If you are not able to solve a problem with your MFC, contact Brother at

USA:	1-800-284-4329	(voice)
	1-908-575-8790	(fax)
From within Canada:	1-800-853-6660	(voice)
	1-514-685-4898	(fax)
From within Montreal:	1-514-685-6464	(voice)

WARNING

For protection against the risk of electrical shock, always disconnect all cables from the wall outlet before servicing, modifying or installing the equipment.

This equipment may not be used on coin service lines provided by the telephone company or connected to party lines.

Brother cannot accept any financial or other responsibilities that may be the result of your use of this information, including direct, special or consequential damages. There are no warranties extended or granted by this document.

WARNING

Important—About the Interface Cable

This machine has been certified to comply with FCC standards, which are applied to the USA only. The shielded interface cable supplied with your MFC should be used according to FCC 15.27 (C). In addition, a grounded plug should be plugged into a grounded AC outlet after checking the rating of the local power supply for the printer to operate properly and safely.

Federal Communications Commission (FCC) Declaration of Conformity (For USA only)

Responsible Party: Brother International Corporation
100 Somerset Corporate Boulevard
Bridgewater, NJ 08807-0911 USA
TEL: (908) 704-1700

declares, that the products

Product Name: MFC 7300C, MFC 7400C

comply with Part 15 of the FCC Rules. Operation is subject to the following two conditions: (1) This device may not cause harmful interference, and (2) this device must accept any interference received, including interference that may cause undesirable operation.

Industry Canada Compliance Statement (For Canada only)

This Class B digital apparatus complies with Canadian ICES-003.

Cet appareil numérique de la classe B est conforme à la norme NMB-003 du Canada.

ENERGY STAR® Compliance Statement

As an ENERGY STAR® Partner, Brother Industries, Ltd. has determined that product meets the ENERGY STAR® guidelines for energy efficiency.



Important Safety Instructions

- 1 Read all of these instructions.
- 2 Save them for later reference.
- 3 Follow all warnings and instructions marked on the product.
- 4 Unplug this product from the wall outlet before cleaning. Do not use liquid or aerosol cleaners. Use a damp cloth for cleaning.
- 5 Do not use this product near water.
- 6 Do not place this product on an unstable cart, stand, or table. The product may fall, causing serious damage to the product.
- 7 Slots and openings in the cabinet and the back or bottom are provided for ventilation; to ensure reliable operation of the product and to protect it from overheating, these openings must not be blocked or covered. The openings should never be blocked by placing the product on a bed, sofa, rug, or other similar surface. This product should never be placed near or over a radiator or heater. This product should never be placed in a built-in installation unless proper ventilation is provided.

- 8 This product should be operated from the type of power source indicated on the label. If you are not sure of the type of power available, consult your dealer or local power company.
- 9 This product is equipped with a 3-wire grounding type plug, a plug having a third (grounding) pin. This plug will fit into only a grounding-type power outlet. This is a safety feature. If you are unable to insert the plug into the outlet, contact your electrician to replace your obsolete outlet. Do not defeat the purpose of the grounding-type plug.
- 10 Do not allow anything to rest on the power cord. Do not place this product where people can walk on the cord.
- 11 If an extension cord is used with this product, make sure that the total ampere ratings on the products plugged into the extension cord do not exceed the extension cord ampere rating. Also, make sure that the total of all products plugged into the wall outlet does not exceed 15 amperes (USA only).
- 12 Do not place anything in front of the machine that will block received faxes. Do not place anything in the path of received faxes.
- 13 Wait until pages have exited the machine before picking them up.
- 14 Never push objects of any kind into this product through cabinet slots, since they may touch dangerous voltage points or short out parts resulting in the risk of fire or electric shock. Never spill liquid of any kind on the product.
- 15 Do not attempt to service this product yourself, as opening or removing covers may expose you to dangerous voltage points and/or other risks, and may void your warranty. Refer all servicing to Authorized Service Personnel. A list of Authorized Service Centers has been included for your convenience, or you may contact Customer Service for your nearest Brother Authorized Service Center. (See *Brother Numbers*, page i.)
- 16 This product does not have an ON/OFF switch. Therefore, it is very important that you have easy access to the main plug and the main socket to which the plug is connected, in case the main power to the MFC must be disconnected quickly.
- 17 Unplug this product from the wall outlet and refer servicing to Authorized Service Personnel under the following conditions:
 - A When the power cord is damaged or frayed.
 - B If liquid has been spilled into the product.
 - C If the product has been exposed to rain or water.
 - D If the product does not operate normally when the operating instructions are followed. Adjust only those controls that are covered by the operating instructions. Improper adjustment of other controls may result in damage and will often require extensive work by a qualified technician to restore the product to normal operation.
 - E If the product has been dropped or the cabinet has been damaged.
 - F If the product exhibits a distinct change in performance, indicating a need for service.

- 18** To protect your product against power surges, we recommend the use of a power protection device (Surge Protector).

Trademarks

The brother logo is a registered trademark of Brother Industries, Ltd.

Brother is a registered trademark of Brother Industries, Ltd.

Multi-Function Link and PhotoCapture Center are registered trademarks of Brother Industries, Ltd.

© Copyright 2000 Brother Industries, Ltd. All rights reserved.

© Copyright 2000 Smith Micro Software, Inc. All rights reserved.

© Copyright 2000 Visioneer, Inc. All rights reserved.

PhotoPrinter Pro is a registered trademark of ArcSoft.

Windows and Windows NT are registered trademarks of Microsoft in the U.S. and other countries.

Microsoft is registered trademarks of Microsoft in the U.S. and other companies.

Macintosh is a registered trademark, and iMac is a trademark of Apple Computer, Inc.

Paper Port and Text Bridge are registered trademarks of ScanSoft™, Inc.

Excel and Word are trademarks of Microsoft Corp.

Each company whose software title is mentioned in this manual has a Software License Agreement specific to its proprietary programs.

IBM, IBM PC and Proprinter are registered trademarks of International Business Machines Corporation.

SmartMedia™ is a trademark of Toshiba Corporation.

Hammermill copypplus white is a registered trademark of International Paper.

All other brand and product names mentioned in this manual are registered trademarks of their respective companies.

24 Troubleshooting and Routine Maintenance

Troubleshooting

fax-back system

Brother Customer Service has installed an easy-to-use fax-back system, so you can get instant answers to common technical questions and product information for all Brother products. This system is available 24 hours a day, 7 days a week. You can use the system to send faxes to any fax machine, not just the one from which you are calling.

If you can't resolve a difficulty with your MFC using this manual, call our fax-back system and follow the voice prompts to receive faxed instructions about using the system, and an index of fax-back subjects.

USA: 1-800-521-2846

From within Canada: 1-800-681-9838

The Brother USA fax-back system number has been preprogrammed on One Touch key 1.

Frequently Asked Questions (FAQs)

You can find more information about Brother products on the World Wide Web. From product specification sheets to Frequently Asked Questions (FAQs), it is all there. Visit us at :

<http://www.brother.com>

Brother Bulletin Board

Brother's Bulletin Board Numbers are

USA: 1-888-298-3616

From within Canada: 1-514-685-2040

Error Messages

As with any sophisticated office product, errors may sometimes occur. If this happens, your MFC often identifies the problem and displays an error message. The table below explains the most common error messages.

You can correct most problems by yourself. If you need additional help, call the Brother Fax-Back System.

USA: 1-800-521-2846

From within Canada: 1-800-681-9838

ERROR MESSAGES		
ERROR MESSAGE	CAUSE	ACTION
CHECK PAPER	MFC is out of paper.	Add paper, and press Start .
COMM. ERROR	Poor phone line quality caused communication error.	Try the call again. If problem continues, call Telephone Company to check your phone line.
CONNECTION FAIL	You tried to poll a fax machine that is not in Polled Waiting mode.	Verify the other party's polling setup.
COOLING DOWN	The print head has overheated.	Unplug the MFC and wait 30 minutes for it to cool.
COVER OPEN	Control panel cover or top cover is not closed completely.	Open, then close the covers.
DISCONNECTED	The other party or other party's fax machine terminated the call.	Try to transmit or receive again.
DOCUMENT JAM	Documents were not inserted or fed properly, or document was longer than about 40" inches (90cm).	See p. 24-3.
INK EMPTY	One or more of the ink cartridges is out of ink.	Replace the ink cartridges. See p. 24-13.
MACHINE ERROR XX	MFC has a mechanical problem.	Call Brother Customer Service. USA: 1-800-284-4329 From within Canada: 1-800-853-6660 From within Montreal: 1-514-685-6464
MEMORY FULL	You can't store data in the memory.	See p. 11-2.
NEAR EMPTY	One or more of the ink cartridges is running out of ink.	Order a new ink cartridge. See p. ii.
NO RESPONSE/ BUSY	The number you dialed does not answer or is busy.	Verify the number and try again.
NOT REGISTERED	You tried to access a One Touch or Speed Dial number that is not programmed.	Set up the One Touch or Speed Dial number. See p. 8-1.
PRINTER JAM	The paper is jammed in the MFC.	See p. 24-4.
SET CARTRIDGES	An ink cartridge is not installed properly.	Re-install the ink, seating it properly. See 24-13.
WARMING UP	The print head detects low temperature.	Wait until the MFC warms up.

Document Jam

If the original is jammed, follow the steps as below.

Document Jam inside front of control panel.

- 1 Remove any paper from the ADF that is not jammed.
- 2 Pull the jammed original out toward the front of the MFC.
- 3 Press **Stop**.

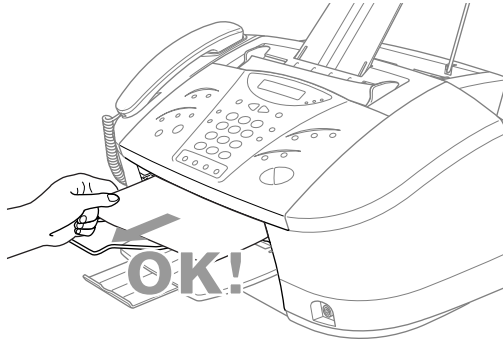

Document Jam inside back of control panel.

- 1 Remove any paper from the ADF that is not jammed.
- 2 Lift the control panel cover.
- 3 Pull the jammed document out toward the back of the MFC.
- 4 Close the control panel cover.

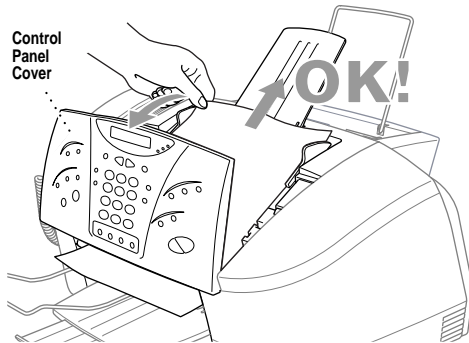

Printer Jam or Paper Jam

Remove the jammed paper depending on where it is jammed in the MFC.

Paper is jammed in the multi-purpose sheet feeder.

- 1 Remove any paper from the multi-purpose sheet feeder that is not jammed.
- 2 Pull the jammed paper upward and remove it.

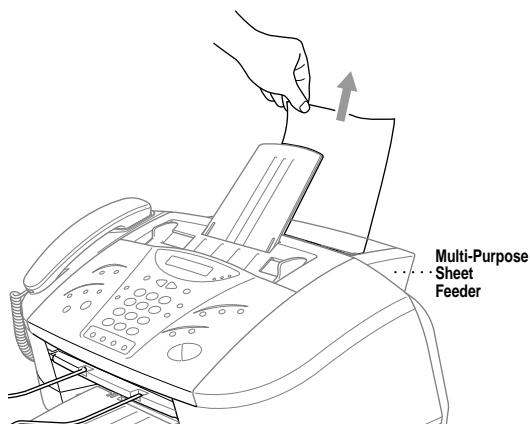

Paper is jammed inside the MFC.

- 1 Open the control panel cover by pulling it toward you, then lift the top cover toward the back.
- 2 Remove the jammed paper.
- 3 Close the control panel cover and top cover.



1 Paper is jammed inside front of MFC.

- 1 Pull the paper toward you.

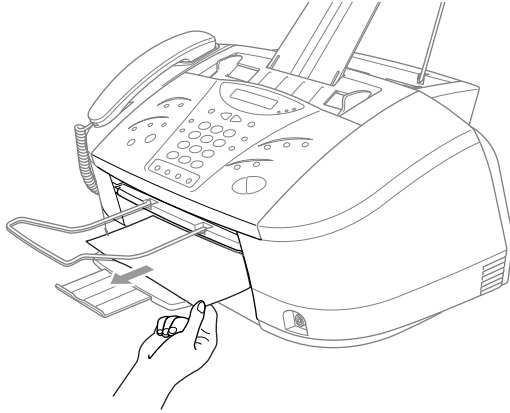

2 Paper is jammed inside back of MFC.

- 1 Open the jam clear cover.
- 2 Pull the paper out of the back of the MFC.
- 3 Close the jam clear cover.
- 4 Press **Stop**, then press **Start**.

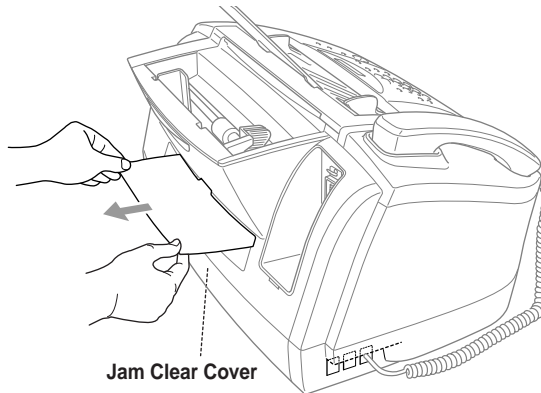

If You Are Having Difficulty with Your MFC

If you think there is a problem with your MFC, *make a copy first*. If the copy looks good, the problem is probably not your MFC. Check the chart below and follow the troubleshooting tips.

DIFFICULTY	SUGGESTIONS
Printing or Receiving Faxes	
Condensed Print and Horizontal Streaks / Top and Bottom of Sentences Are Cut Off	If your copy looks good, you probably had a bad connection, with static or interference on the phone line. If the copy looks bad, call Brother Customer Service at 1-800-284-4329 (USA), 1-800-853-6660 (from within Canada) or 1-514-685-6464 (from within Montreal).
Poor Quality Print	Make sure the Printer Driver matches the type of paper you are using (see 15-1). If you are using plain paper, try using recommended special paper (see Chapter 3). Don't handle the paper until the ink is dry. Adjust the Vertical Alignment (see page 24-9).
Smudged stain on the top center of the printer page	Press the purple paper thickness adjustment lever down. (See <i>Loading, paper</i> , page 15-3.)
Printing Too Dark or Too Light	Make sure your ink cartridges are fresh. Cartridges are good up to two years, after that the ink may become clogged. Cartridge expiration dates are printed on the package. Make sure the Printer Driver matches the type of paper you are using (see 15-1.). Try using recommended special paper (see Chapter 3). The recommended environment for your MFC is between 50°F to 95°F.
Printing Appears Dirty or Ink Seems to Run	Make sure you are using the recommended paper (see Chapter 3). Don't handle the paper until the ink is dry. The recommended environment for your MFC is between 50°F to 95°F.
White Lines in Text or Graphics	Clean the print head (see <i>Cleaning the print Head</i> , page 24-8.).
Stains Appear on the Reverse Side or at the Bottom of the Page	Make sure the Printer Platen and Pick Up Roller are not dirty with ink mist. (See page 24-13).
Vertical Black Lines When Receiving	The sender's scanner may be dirty. Ask the sender to make a copy to see if the problem is with the sending machine. Try receiving from another fax machine. If the problem continues, call Brother Customer Service at 1-800-284-4329 (USA).
Phone Line or Connections	
MFC Does Not Answer When Called	Make sure the MFC is in the correct receiving mode for your setup (either MANUAL, FAX, FAX/TEL or TAD). Check for dial tone. If possible, call your MFC to hear it answer. If there is still no answer, check the telephone line cord connection. Connect a standard telephone handset to the MFC telephone jack. If there is no ringing when you call your MFC, call your Telephone Company to check the line.
No Dial Tone on the Handset	Check telephone line cord connections at the MFC and wall jack. Check that the handset is connected to the MFC's handset jack. Test the wall jack with another single line telephone. If no dial tone on the wall outlet, call your Telephone Company.
Sending Faxes	
Poor Transmitting Quality	Try changing your resolution to FINE or SUPERFINE. Make a copy to verify your MFC's scanner operation.
Transmission Verification Report says "Result:NG"	There is probably temporary noise or static on the line. Try sending the fax again. If the problem continues, call the Telephone Company to check your phone line.
Vertical Black Lines When Sending	If the copy you made shows the same problem, your scanner is dirty (see <i>Cleaning the Scanner</i> , page 24-12.).

DIFFICULTY	SUGGESTIONS
Handling Incoming Calls	
Double Ring in FAX/TEL Mode	The MFC knows the incoming call is not a fax so it is signaling you to answer the telephone call. Pick up the MFC handset or answer from an extension phone and press your MFC's Telephone Answer Code (default setting is #51).
Transferring a Fax Call to the MFC	If you answered at the MFC, press Start and hang up immediately. If you answered at an extension phone, press your Fax Receive Code (default setting is *51). When your MFC answers, hang up.
Custom Features on a Single Line	If you have Call Waiting, Caller ID, Call Waiting/Caller ID, Ring Master, Voice Mail, alarm system or any other custom feature on a single phone line with your MFC, it may create a problem sending or receiving fax data. For example: If you are sending or receiving a fax message while a custom feature signal comes through on the line, the signal can temporarily interrupt or disrupt the fax data. Brother's ECM feature should help overcome this problem. This condition is related to the telephone system industry, and is common to all devices that send and receive information on a single, shared line with custom features. If avoiding a slight interruption is crucial to your business, a separate line with no custom features is recommended.
Printer Difficulties	
Horizontal lines appear in Text or Graphics.	Clean the print head (see <i>Cleaning the Print Head</i> , page 24-8.). If you clean the print heads five times and the print has not improved, call Brother Customer Service at 1-800-284-4329 (USA), 1-800-853-6660 (from within Canada) or 1-514-685-6464 (from within Montreal).
Cannot perform '2 in 1' printing.	Check that the paper size setting in the application and in the printer driver are the same.
Cannot print when using Paint Brush.	Try setting the Display setting to '256 colors'.
Cannot print when using Adobe Illustrator.	Try to reduce the printing resolution.
Thick line and thin line appear alternately. (banding)	Turn OFF 'Bi-Directional Printing' from the 'Quality/Color' tab in the printer driver.
There are some dense lines.	Turn ON 'Reverse Order' from the 'Paper' tab in the printer driver.
When using ATM fonts, some characters are missing or some characters are printed in the same place.	If you are using Windows [®] 95 or 98, select 'Printer Settings' from the 'Start' menu. Open 'Brother XXXX' properties. Click 'Spool Setting' on the 'Details' tab. Select 'RAW' from 'Spool Data Format'. Do NOT clean the print head by touching it with your hand or a cloth (see page 24-8).
When using Power Point or Excel, hatch pattern is not what you are expecting.	Open the 'Quality/Color' tab in the printer driver, and change the 'Document Type' to 'Photo'.
Printing is slow.	In the Quality/Color tab of the Print dialog box, select Auto in the Document section.
True2Life is not working correctly.	If the image data is not full color (such as 256 color) in your application, True2Life does not function. Please use at least 24 bit color data with the True2Life feature.
Video Capture	
LCD does not show "Video: Press Copy/Capture Ready"	Check the video cable connection to the MFC's RCA pin jack. Check that the video equipment is sending a signal (video equipment is turned on and set to the correct setting).

How to Improve Print Quality

Test Print

If the quality is not satisfactory, first print a test page to help you identify settings you may want to change.

- 1 Press **Function**, **2**, **1**.
- 2 Press **Start**. The MFC begins printing.
- 3 Press **Stop** to exit.

1. TEST PRINT



Cleaning the Print Head

Clean the print head if you get a horizontal line in the text or graphics on your printed documents. You can clean the four color (black, cyan, yellow, magenta) print heads (or a single color) by using **Ink Management**.



Caution

Do NOT clean the print head by touching it with your hand or a cloth.

- 1 Press **Ink Management**.
- 2 Press **1** to choose **1.CLEANING**.
- 3 Press  or  to choose the color you want to clean and press **Set**.

The MFC will clean the print head automatically. When cleaning is finished, the MFC will go back online automatically.



If you clean the print head at least five times and the print has not improved, call Brother Customer Service for assistance at 1-800-284-4329 (**USA**), 1-800-853-6660 (**from within Canada**), or 1-514-685-6464 (**from within Montreal**). You may have to replace the print head. (Replacement instructions are included with the HD004, print head accessory).



WARNING

Do NOT touch the print head unless you are replacing it. Touching the print head may cause permanent damage and may void the print head's warranty.

Aligning Ink Cartridges

This feature allows you to check and align the ink cartridges to assure best print quality. Make sure there is paper in the cassette before you start the alignment procedure.

- 1 Press **Function, 2, 2**.

2.VERTICAL ALIGN

- 2 Press **Start**. The MFC prints a sample page.

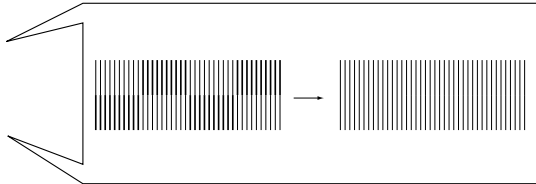
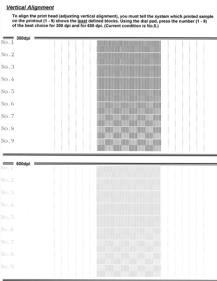

Study the alignment page and decide which sample numbers show the most evenly printed ink lines for 300 and 600 dpi.

300 DPI ADJUST
ENTER NO. (1-9)

- 3 Using the dial pad, enter the level of adjustment needed for 300 dpi (1 to 9).

600 DPI ADJUST
ENTER NO. (1-9)

- 4 Using the dial pad, enter the level of adjustment needed for 600 dpi (1 to 9).
- 5 Print another sample Test Print and check it (see page 24-8).
- 6 Press **Stop** to exit.

Turning Off Bi-directional Printing

You can further improve print quality by turning off bi-directional printing and setting the MFC to print in one direction only. However, this will reduce print speed by one half.

- 1 Press **Function, 2, 3**.

3.BI-DIR PRINT

- 2 Press ◀ or ▶ to select **OFF**.

Don't handle the paper until the ink is dry.

Special ink jet, glossy and transparency paper will take longer to dry than plain paper, so do not touch the printed copy until the ink has dried.

Packing and Shipping the MFC

Whenever you transport the MFC, use the packing materials that came with your MFC. If you do not pack the MFC correctly, you could void your warranty.

- 1 Unplug the MFC from the telephone wall socket.
- 2 Unplug the MFC from the AC outlet.

! Caution

Do not unplug the MFC after a print job until you hear the final click.

- 3 Remove the paper wire extension, paper tray, document support, document wire extension, and handset, and keep them. If you are packing the machine for a Swap Return with Brother, keep these items and return only the machine.

! Caution

Please remove the ink cartridges and attach the yellow shipping cover. Damage to your print head resulting from packing without the yellow shipping cover will void your warranty.

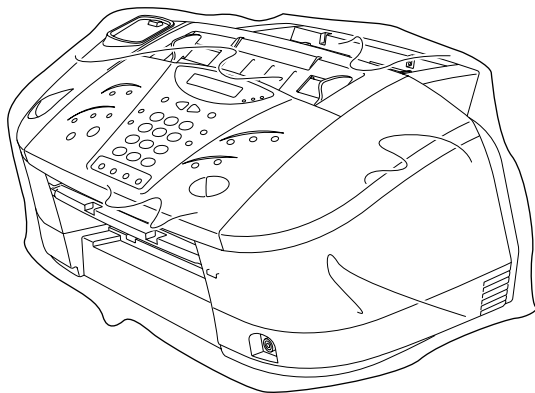

- 4 Wrap the MFC in the plastic bag and place it in the original carton with the original packing material.

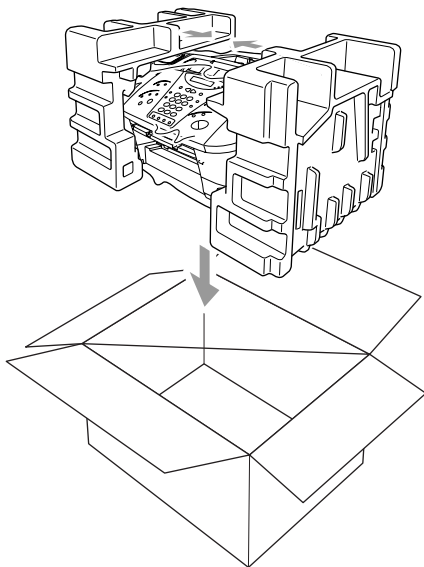

- 5 (Skip this step for Swap Returns to Brother.) Place additional parts (cords, trays, wire extensions and printed materials cords and trays) and documents (manual and printed material) into the carton.

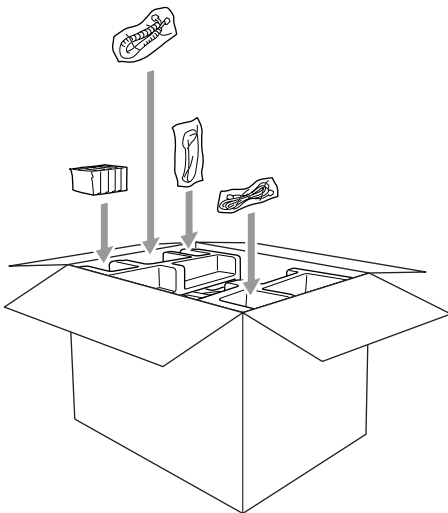

If you are returning your machine to Brother as part of the Swap Program, pack only the MFC. Keep all separate parts and printed materials to use with your “Swap” machine.

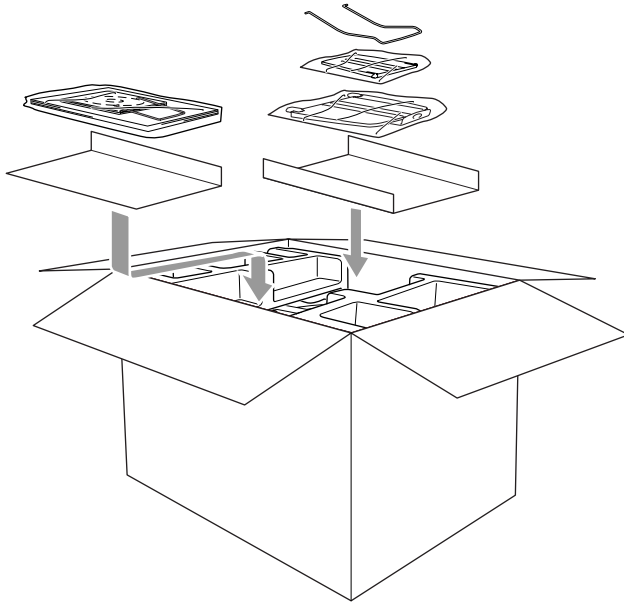

6 Close the carton.

Routine Maintenance

Cleaning the Scanner

Unplug the MFC and open the control panel cover and lift the top cover. Clean the flat white pressure bar and the glass strip under the bar with isopropyl alcohol on a lint-free cloth.

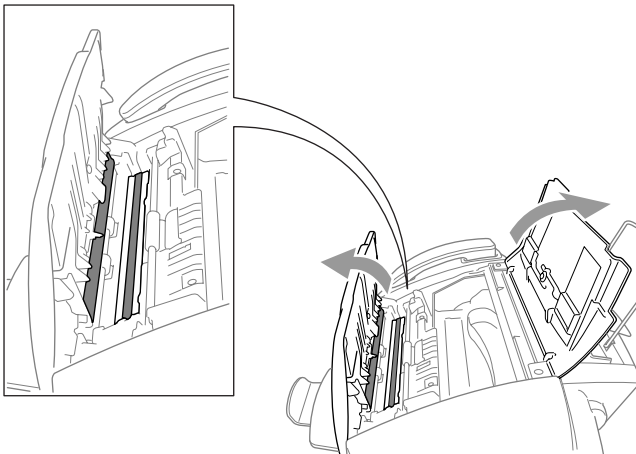

Cleaning the MFC Printer Platen

When you want to clean your MFC printer platen, wipe it with a lint free cloth that is dry or lightly moistened with isopropyl alcohol.

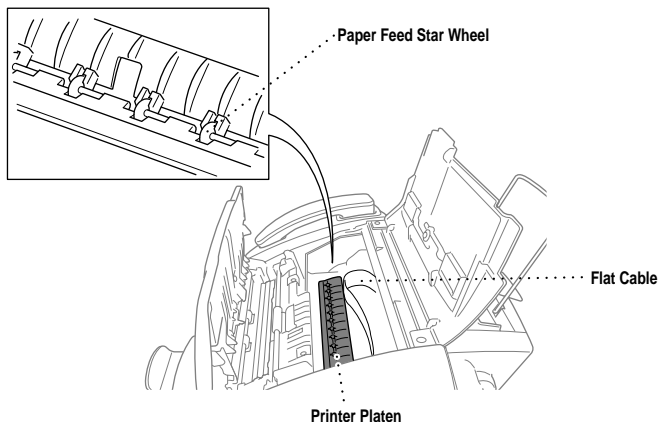

WARNING



- Be sure to unplug the MFC from the main power outlet before cleaning the printer platen.
- Be careful not to touch the paper feed star wheels and flat cable.

Replacing the Ink Cartridges

Your MFC is equipped with an ink dot counter that automatically monitors the ink level in each color cartridge. When the counter detects an ink cartridge is running out of ink, the MFC will notify you with a message on the LCD.

The display shows you which color cartridges are low or empty. Be sure to follow the display prompts so you replace the color cartridges in the appropriate order.

When the ink cartridges are running low, you must use Ink Management to begin the cartridge replacement (Steps 1–3). If the ink is empty, skip to Step 4.

- 1 Press **Ink Management**.
- 2 Press  or  to choose 2. REPLACE INK.
- 3 Press **Set**.
If one or more ink cartridges are empty, for example Black, the screen displays **INK EMPTY BLACK** and **PLS OPEN COVER**.
- 4 Open the control panel cover and lift the top cover.

- 5 Remove the ink cartridge by pulling it toward you and lifting it up and out of the print head.

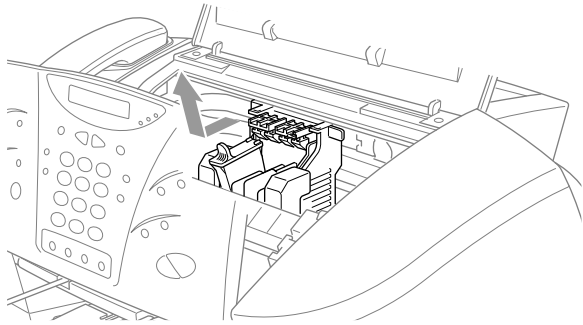

- 6 Open the new ink cartridge bag for the color on the display and remove the ink cartridge.

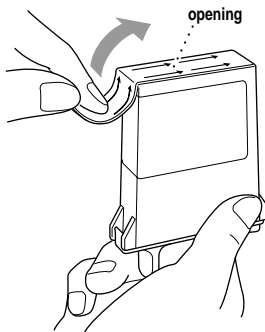

Peel in the direction
away from you!

7 Hold the new ink cartridge as shown in the illustration, and peel the sealing tape from the side of the ink cartridge. Carefully peel the tape in the direction away from you.



To prevent spilling ink and staining your hands and clothing, remove the sealing tape gently.

- 8 Each color has its own correct position. Insert each new ink cartridge into the carriage using the color indicator on the cartridge holder as a guide.
- 9 After installing the ink cartridges, close the top cover and control panel cover. Your MFC prepares for a “head cleaning” and goes online. The display screen prompts you to verify a new ink cartridge was inserted for each color you removed. Example: **DID YOU CHANGE BLCK 1. YES 2. NO.** If the ink cartridge you installed is not a brand new one, please make sure to select 2.
- 10 For each new cartridge, Press **1** on the dial pad to reset the ink dot counter for that color automatically. (The ink dot counter enables the MFC to notify you when a color is running low.) The MFC will enter a cleaning cycle for approximately 3 minutes for each replaced cartridge. The display screen alternately shows **CLEANING** and **PLEASE WAIT**. When the MFC completes the cleaning cycle, the display returns to Standby mode (date and time).

WARNING

If ink gets in your eyes, irrigate them with water immediately and consult a doctor if you are concerned.

Caution

- DO NOT remove ink cartridges if you do not need to replace them. If you do so, it may reduce the ink quantity and the printer will not know the quantity of ink left in the cartridge.
- DO NOT shake the ink cartridges, because the ink may spill when you take off the sealing tape.
- If ink stains your body or clothing, wash with soap or detergent immediately.
- If you install an ink cartridge in the wrong color position, you must clean the print head several times before you start printing, after correcting the cartridge installation, because the colors were mixed.
- Once you open an ink cartridge, install it in the MFC and use it up within six months of installation. Use unopened ink cartridges by the expiration date written on the cartridge package.
- DO NOT refill the ink cartridges. Attempting to use refilled cartridges may cause damage to the print head and will void your warranty.



If the INK EMPTY error message is on the display after you have installed ink cartridges, check that the ink cartridges are installed correctly.

If you still cannot solve a problem with your MFC, call Brother Customer Service (see *Brother Numbers*, page i).

Glossary

- Activity Report** Lists information about the last 50 incoming and outgoing faxes. TX means Transmit. RX means Receive.
- ADF (Automatic Document Feed)** Refers to the number of pages that can be placed in the document feeder and fed one at a time automatically.
- Auto Dial List** A listing of names and numbers stored in One Touch and Speed Dial memory, in numerical order.
- Automatic E-Mail Printing** Software application that automatically prints incoming e-mail messages on the MFC (on the CD-ROM).
- automatic fax transmission** Sending a fax without picking up the handset.
- Automatic Redial** A feature that enables your MFC to redial the last fax number if the original fax did not go through because the line was busy or there was no answer.
- Backup Print** Sets your MFC to print a copy of faxes that are received and stored in memory.
- beeper** The sound the keys make when they are pressed, an error occurs or a document has been received or transmitted.
- beeper volume** Volume setting for the beep when you press a key or make an error.
- Brightness** Changing the Brightness makes the whole image lighter or darker.
- broadcasting** The ability to send the same fax message to more than one location.
- Call Back Message** Allows you to send a fax and then leave a message for the other party to call you back.
- Call Reservation** Allows you send a fax and then at the end of transmission, you can talk with the other party.
- Caller ID** A service purchased from the Telephone Company that lets you see the number (or name) of the party calling you.
- Cancel Job** Cancels a programmed job, like Delayed Fax or Polling.
- CNG tones** The special tones (beeps) sent by fax machines during automatic transmission to tell the receiving machine that they are a from fax machine.
- communication error (or Comm. Error)** An error during fax sending or receiving, usually caused by line noise or static.
- Coding Method** Method of coding the information contained in a document. All fax machines must use a minimum standard of Modified Huffman (MH). Your fax machine is capable of greater compression methods, Modified Read (MR) and Modified Modified Read (MMR), if the receiving machine has the same capability.
- Compatibility Group** The ability of one fax unit to communicate with another. Compatibility is assured between ITU-T Groups.
- Contrast** Setting to compensate for dark or light documents, by lightening dark documents or darkening light documents.

Cover Page Prints a page at the other party's machine, that contains the sender and recipient's name and fax number, number of pages and comment. You can generate an electronic cover page at the other end with pre-programmed information from memory or you can print a sample cover page to fax with your document.

Cover Page Message The comment that is on the Cover Page. This is a programmable feature.

Delayed Fax Sends your fax at a later time that day.

Distinctive Ring A service purchased from the Telephone Company that provides another phone number on an existing phone line. The Brother MFC uses the new number to simulate a dedicated fax line.

Dual Access (Not available for color fax) Your MFC can scan outgoing faxes or scheduled jobs into memory at the same time it is sending a fax or receiving or printing an incoming fax.

Easy Receive Enables your MFC to respond to CNG tones if you interrupt a fax call by answering it.

ECM (Error Correction Mode) Detects errors during fax transmission and resends the page(s) of the document that had an error.

Electronic Cover Page A preprogrammed cover page that is transmitted from the fax machine's memory, eliminating the need for making up cover pages manually.

E-Mail Printing Software application that automatically retrieves your e-mail messages from your POP3 server and prints them on your MFC.

extension phone A telephone on the fax number that is plugged into a separate wall jack.

external phone A TAD (telephone answering device) or telephone that is plugged into the EXT jack of your MFC.

F/T Ring Time The length of time the MFC rings (when the answer mode setting is FAX/TEL) to notify you to pick up a voice call that it answered.

FAX/TEL mode You can receive faxes and telephone calls. Do not use FAX/TEL if you are using an external answering machine.

Fax Forwarding Sends a fax received in memory to another preprogrammed fax number.

Fax Storage You can print stored faxes later, or retrieve them from another location using Fax Forwarding, Paging, or Remote Retrieval functions.

fax tones The signals sent by sending and receiving fax machines while communicating information.

Fine Mode Resolution is 196 x 203 dpi. It is used for small print and graphs.

Function Mode The programming mode for changing the settings of your MFC.

gray scale The shades of gray available for copying and faxing photographs.

group number A combination of One Touch and/or Speed Dial numbers that are stored on a One Touch key for Broadcasting.

Ink Management button Cleans the print head and/or resets the ink dot counter after replacing an ink cartridge.

interval The preprogrammed time period between automatically printed Activity Reports. You can print Activity Reports on demand without interrupting this cycle.

LCD (liquid crystal display) The display screen on the MFC that shows interactive messages during On-Screen Programming and defaults to the date and time when the machine is idle.

manual fax When you lift the handset so you can hear the receiving fax machine answer before you press Start to begin transmission.

Memory Status List Shows how much memory is being used, how much is left, and the type of messages in memory.

Multi-Function Link® Pro Software application Turns your MFC into a printer and a scanner and enables PC faxing (For MFC 7400C only) using the MFC. (Optional Brother Software application)

Next Fax Reservation Accepts the next document in the document feeder for transmission while the Memory is full.

One Touch Keys on the MFC control panel where you can store numbers for easy dialing. You must use a separate key for each number.

Out of Paper Reception Receives faxes into the MFC's memory when the machine is out of paper.

Overseas Mode Makes temporary changes to the fax tones to accommodate noise and static on overseas phone lines.

Paging Feature enables your fax unit to call your pager when a fax is received into its memory.

Pause Allows you to place a 3.5 second delay in the dialing sequence stored on One Touch and Speed Dial numbers.

Photo Mode A resolution setting that uses varying shades of gray for the best representation of photographs.

polling The process of a fax machine calling another fax machine to retrieve waiting fax messages.

printer alarm Audible alarm when the printer is not able to print.

Pulse (For Canada only) A form of rotary dialing on a telephone line.

Real Time Transmission When memory is full, you can send documents in real time.

reduction reduces the size of incoming faxes.

remaining jobs You can check which jobs are waiting in memory and cancel jobs individually.

remote activation allows you to transfer a fax call, answered at an extension phone, to the MFC.

remote retrieval access code The four-digit code (159✳) that allows you to call and access your MFC from a remote location.

resolution The number of vertical and horizontal lines per inch. See: Standard, Super Fine and Photo.

Ring Delay The number of rings before the MFC answers in FAX or FAX/TEL mode.

Ring Volume Volume setting for the MFC's ring.

scanning The process of sending an electronic image of an original paper document into your computer.

ScanSoft™ PaperPort® LE for Brother A document management application that enables you to view incoming faxes and scanned documents.

speed dial A preprogrammed number for easy dialing. You must press the **Search/Speed Dial** button and then #, two digit code to start the dialing process.

Standard resolution 98 x 203 dpi. It is used for regular size text and quickest transmission.

Station ID The stored information that appears on the top of faxed pages. It includes the sender's name and fax number.

super fine resolution 392 x 203 dpi. Best for very small print and line art.

TAD (telephone answering device) You can connect an *external* TAD to the EXT. jack of the MFC for TAD mode.

Tel-index An electronic, alphabetical listing of stored One Touch, Speed Dial and Group numbers.

Temporary Setting You can select certain options for each fax transmission without changing the default settings.

transmission The process of sending documents over the phone lines from your MFC to the receiving fax machine.

User Setting List A printed report that shows the current settings of your MFC.

Xmit Report (Transmission Report) A listing of each transmission, date, time, and number of pages.

S Specifications

Product Description

The MFC 7300C is a 5 in 1 Multi-Function Center: Color Printer, Color Copier (single copies), Color Scanner, Plain Paper Fax, and Video Capture. The MFC 7400C is a 6 in 1 Multi-Function Center: Color Printer, Color Copier (multiple copies), Color Scanner, Plain Paper Fax, PC Fax (via your PC) and Video Capture/PhotoCapture Center™.

Fax

Compatibility	ITU-T Group 3
Coding System	MH/MR/MMR/JBIG (Only for MFC7400C) / JPEG
Modem Speed	14400/12000/9600/7200/4800/2400 Automatic Fallback
Cut Sheet Size	Min. 3.5" (W) x 5.0" (L) Max. 8.5" (W) x 14.0" (L)
Scanning/Printing Width	8.2 inches (208 mm)
Paper Cassette	100 Sheets (20 lbs.)
Printer Type	Ink Jet
Gray Scale	256 levels (Error Diffusion)
Display	LCD, 16 characters
Polling Types	Standard, Sequential
Contrast Control	Automatic/Super Light/Super Dark (manual setting)
Resolution	<ul style="list-style-type: none">• Horizontal 203 dot/inch (8 dot/mm)• Vertical Standard—98 line/inch (3.85 line/mm) Fine, Photo—196 line/inch (7.7 line/mm) Superfine, Photo—392 line/inch (15.4 line/mm)
Memory Capacity	MFC 7300C—2 MB (up to 100 pages) MFC 7400C—4 MB (up to 180 pages)
One Touch Dial	4 x 2

Speed Dial	100 stations
Automatic Redial	3 times at 5 minute intervals
Auto Answer	0, 1, 2, 3 or 4 rings
Communication Source	Public switched telephone network
Operating Environment	50–95° F (10–35° C)
Best Print Quality	68–91° F (20–33° C)
Power Source	120V AC 50/60Hz (USA, Canadian Version Only)
Power Consumption	Standby: under 10 watts Peak: under 45 watts
Dimensions	18.4 x 13.8 x 9.0 (inches) 468 x 352 x 228 (mm)
Weight	18lb/8kg

* “Pages” refers to the “Brother Standard Chart No. 1” (a typical business letter, Standard resolution). Specifications and printed materials are subject to change for improvement without prior notice.

Printer

Printing

Print Method	Piezo with 107 x 4 nozzles
Resolution	1200 x 1200 dots per inch (DPI) 600 x 600 dots per inch (DPI) 300 x 300 dots per inch (DPI) 300 x 150 dots per inch (DPI)
Print Speed	up to 12 pages/minute (Mono) up to 10 pages/minute (Color)
Print Width	8 inches (203.2 mm)
Disk-Based Fonts	35

Controller

Parallel Interface

A bi-directional shielded IEEE 1284 Compliant parallel interface that is no longer than 6 feet (1.8m)

USB Interface

A Standard Universal Serial Bus cable that is no longer than 6 feet (1.8m)



To meet FCC emission requirements for the MFC, you must attach the included filter core and cable tie to the Parallel or USB cable.

Print Media

Paper Input

Automatic loading from the Multi-Purpose Sheet Feeder

- Paper type:
Plain paper, coated paper, glossy paper, transparencies, organizer paper (K, L) and envelopes
- Paper size:
Letter, Legal, A5, Executive, envelopes (COM-10, DL, C5, B5, Monarch) organizer (K, L), Postcard, Photo.
 - Width 5.8–8.5" (148–216 mm)
 - Length 5–14" (127–356 mm)
 - Weight 17–32 lb (64–120 g/m²)
- Maximum feeder capacity: Approx. 100 sheets of 20 lb (75 g/m²) plain paper.

Paper Output

Approximately 50 sheets of plain paper (Face up print delivery to the paper output tray) It is recommended that printed sheets are taken from the paper output tray immediately after printing.

Consumable Items

Ink

Black and 3 individual color ink cartridges separate from the print head

Service Life of Ink Cartridge

Approximately 850 page/Black cartridge at 10% coverage

Approximately 410 page/Color cartridge at 10% coverage

Index

A

- Access codes, storing 8-6
- Accessories and Supplies ii
- Activity Report 10-1, 10-2
- ADF (Automatic Document Feeder) 7-1
- All Dial List 10-1
- Alternating Displays 4-2
- Assembly 2-3
 - document wire extension 2-6
 - grounded 3-prong plug 2-3
 - loading paper 2-6
 - paper tray 2-5
 - paper wire extension 2-4
 - plastic document support 2-5
 - plastic extension 2-5
- Automatic
 - dialing 8-5
 - fax receive 6-1
 - fax redial 7-3
 - transmission 7-3
- Automatic Transmission 7-3

B

- Beeper 5-4
- Beeper Volume 5-4
- Beeps 9-3
- BI-DIR PRINT 4-5, 15-4
- Bi-directional Parallel Cable 2-1, 14-2, 14-3
- Brightness 1-3, 1-4, 12-3
- Broadcasting
 - setting up groups for 8-4
- Brother
 - accessories and supplies ii
 - Brother numbers i
 - Bulletin Board i
 - Customer Service i
 - fax-back system i
 - Frequently Asked Questions (FAQs) i
 - on the World Wide Web i

- test sheet, sending 1-2
- Brother Bulletin Board i
- Brother Control Center
 - using and configuring 17-2- 17-16
- Brother Paper 3-1

C

- Call Back Message 5-1, 7-9
 - print sample 7-9
- CALL PICKUP 6-10
- Call Reservation 7-9
- Call Waiting Caller ID 6-11
- Caller ID 6-10
- Canceling
 - fax forwarding 9-4
 - fax jobs in memory 6-8
 - jobs awaiting redial 7-5
 - paging 9-4
 - scheduled job 6-8
- Cleaning
 - cycle 2-9
 - print head 24-8
 - printer platen 24-13
 - Scanner 24-12
- Clear 1-3, 1-4
- CNG Tones 1-5
- Color Adjustment 11-7
- Computer Requirements 14-2
- Connecting 2-1
- Contrast 7-2
- Control Panel 1-3
- Control panel cover 2-7, 24-3
- convert to an RJ11 jack 2-13
- Converting Telephone Wall Outlets 2-13
- Copy
 - Color Copy 11-1
 - contrast 11-8
 - default setting 11-6
 - Enlarge/Reduce 11-2
 - keys 11-2

- Mono Copy 11-1
 - multiple 11-1
 - quality 11-3, 11-7
 - Resolution 1-3, 1-4
 - single 11-1
- Corrections 5-2
- Cover Page 5-1, 7-6, 7-7, 7-8
 - composing 7-6
 - custom comments 7-6
 - for all faxes 7-7
 - for next fax only 7-7
 - printed form 7-8
- Credit Card Numbers 8-6
 - dialing 8-6
 - storing 8-6
- Custom telephone features 2-15, 24-7
- Customer Service i

D

- Dark Document 7-2
- Date and Time setting 5-1
- Delayed Batch Transmission 7-10
- Delayed Fax 7-10
- Dialing
 - automatic fax redial 7-3
 - Groups 8-7
 - One Touch numbers 8-5
 - Search 8-6
 - Speed Dial numbers 8-5
- Distinctive Ringing 6-8, 6-9
- Document Jam 24-3
- Document Size and Resolution 7-1, 7-2
- Drivers
 - installing
 - iMac[™]/Macintosh[®]G3, G4 22-2
 - Windows[®]Parallel 14-2
 - Windows[®]USB 14-17
 - printer 16-1
 - TWAIN COMPLIANT 18-4
- Dual Access 7-4

E

- Easy Receive 6-3
- ECM (Error Correction Mode) 1-5
- Emergency numbers 23-1
- Enlarge/Reduce Key 1-3, 1-4, 11-2
- Entering Text 5-2
- Envelopes 3-2, 3-3
- Error Messages on LCD 24-2
 - BLCK 1. YES 2. NO 24-14
 - CHECK PAPER 24-2
 - CLEANING 24-14
 - CLEANING BLACK 2-9
 - COMM. ERROR 24-2
 - DID YOU CHANGE 24-14
 - INK EMPTY 2-9
 - MEMORY FULL 24-2
 - while scanning a document 7-4, 11-2
 - NOT REGISTERED 24-2
 - PLEASE WAIT 2-9, 24-14
- Extension Telephone, using 6-5
- External Telephone 2-10
- External Telephone Answering Device (TAD) 1-5
- External Two-Line TAD 2-13

F

- Fax codes
 - Fax Receive Code 6-5
 - Remote Retrieval Access Code 9-2
 - troubleshooting 6-6
- Fax Forwarding 9-1
 - changing remotely 9-4, 9-6
 - programming a number 9-1
- FAX Mode 1-5
- Fax Receive Code 6-3, 6-5
- Fax Receiving Tones 1-5
- Fax Redial 7-3
- Fax Strage 9-2
 - printing from 6-6
 - setting 9-2
- Fax Tones 1-5
- Fax, stand-alone
 - receiving 6-1

- difficulty 24-6
- erasing from memory 9-2
- erasing from the memory 9-4
- forwarding 9-1, 9-4
- polling 6-6
- reducing to fit on paper 6-4
- retrieving from a remote site 9-5
- sending
 - automatic fax redial 7-1
 - automatic transmission 7-3
 - canceling from memory 7-5
 - Color Fax 7-3
 - color Fax 7-3
 - Cover page 7-6
 - delayed 7-10
 - from memory (dual access) 7-4
 - in real time 7-4
 - manual transmission 7-3
 - Overseas 7-8
 - Polling 7-11
- FAX/TEL mode 1-5, 6-3
 - answering at extension phones 6-5
 - double ringing (voice calls) 6-3
 - Fax Receive Code 6-6
 - receiving faxes 6-3
 - Ring Delay, setting 6-2
 - Telephone Answer Code 6-5
- FCC Notices 23-1
- Filter Core 14-3
 - attach to a bi-directional parallel cable 14-3
 - attach to a USB cable
 - for Macintosh user 22-1
 - for Windows user 14-17
- Fine Resolution 7-2
- Fixed reduction 6-4
- Function
 - programming at-a-glance 4-2

G

- Gray scale S-1
- Groups for Broadcasting 8-4
 - setting up 8-4

H

- Handset 2-1
 - connecting 2-3
 - volume 5-4
- Hearing aid compatible 5-4, 23-1
- HELP 1-3, 1-4
- Hold 1-3, 1-4, 8-8

I

- iMac 22-1
- Importing 18-4
- Improving print quality
 - maintenance, routine 24-12
- Ink Cartridges 2-1, 2-7, 2-8, 2-9
 - Aligning 24-9
 - Installing 2-7
 - Replacing 24-13
- Ink Dot Counter 2-8
- INK EMPTY 24-2
- Ink Management 1-3, 1-4, 24-8
- Inserting Spaces 5-2
- Installing Brother Software
 - address i
 - helpful hints for Windows[®] 14-31
 - Multi-Function Link[®] Pro 14-27

J

- Jack 2-12, 2-13
 - EXT. jack
 - external telephone 2-10
 - TAD (answering machine) 2-10

L

- LCD (Liquid Crystal Display) 1-3, 1-4, 4-1
- Light Document 7-2

M

- Macintosh[®] G3, G4 or iMac[™] 22-1
- Manual
 - mode 6-1
 - transmission 7-3

- Manual Transmission 7-3
- Memory 2-2, 10-1
- MEMORY FULL 7-4, 11-2
- Memory Status List 10-1
- Memory Storage 5-5
- Mono Copy 1-3, 1-4
- Multi-Function Link[®]
 - receiving faxes 14-32
- Multi-Function Link[®] Pro
 - Install MFL-Pro 14-27
 - receiving faxes 14-32
- Multi-Line Connections (PBX) 2-14
- Multiple Resolution 7-11
- Multi-purpose Sheet Feeder 2-4
 - loading paper 2-6

O

- On/OffLine Key 1-3, 1-4
- One Color 4-5
- One Touch List 10-1
- One Touch numbers
 - accessing with shift key 8-1
 - changing 8-3
 - dialing 7-3, 8-1, 8-4, 8-5, 8-6
 - listing 10-1
 - storing 8-1
- On-Screen Programming 4-1
- Options Key 11-4, 12-3
 - Brightness 11-4
 - Paper Type 11-4
 - Special Copy Options 11-4
- OUT-OF-AREA 6-10
- Overseas, sending faxes 7-8

P

- Packing List 2-1
- Paging 9-1, 9-2
 - programming a number 9-1
- Paper 3-1
 - Ink Jet 3-1
 - Coated Paper 3-1
 - Glossy Paper 3-1
 - Transparencies 3-1

- Size 6-5
- Specifications 3-2
 - Type 1-3, 1-4, 4-5, 11-7, 12-3, 12-6
- Paper Jam 24-4
- Paper Sizes setting 6-5
- PaperPort 18-1
 - accessing 18-5
- Paperport
 - accessing 18-5
 - exporting 18-4
 - importing 18-4
- PBX 2-14
- Phone Line difficulties 24-6
- PhotoCapture Center[™] 13-1
 - Compact Flash[™] 13-1
 - DPOF Printing 13-2
 - Printing Thumbnails 13-2
 - SmartMedia[™] 13-1
- Polling 6-6, 7-11
 - receiving 6-7
 - sequential receiving 6-7
- Power 2-2, 2-3
 - cord 2-3
 - electrical outlet 2-3
 - failure 5-5
- Power Cord 2-1
- Power Switch 2-3, 2-7
- Print Area 3-3
- Print Size 3-2, 4-6, 12-3, 12-7
- Printer Jam 24-4
- Printing 6-6, 7-8, 7-9, 10-1
 - difficulty 24-6
 - resolution S-2
 - specifications S-2
- Printing speed S-2
- Priority Key 1-3, 1-4

Q

- Quality 4-6
- Quality Key 11-3, 12-2

R

- Real Time Transmission 7-4
- Receive Mode 6-1
 - FAX 6-1
 - FAX/TEL 6-1
 - MANUAL 6-1
 - TAD, external 2-10, 6-1
- Redial/Pause 1-3, 1-4, 7-3, 8-8
- Reducing
 - copies 11-2
 - long faxes 6-4
- Remote Codes for extension phones 6-6
- Remote Fax Options 9-1
- Remote Retrieval 9-3
 - access code 9-2
 - changing 9-2
 - using 9-3
 - checking what's in memory
 - Memory Status List 9-5
 - commands 9-4
 - getting your faxes 9-5
 - Memory Status 9-5
- Reports 10-1
 - Help list 10-1
 - how to print 10-1
 - list of last 50 faxes 10-1
 - list of your stored numbers 10-1
 - order form 10-1
 - proof fax was sent 10-2
 - types of 10-1
- Resolution 1-3, 1-4, 7-2, 7-11
 - fax (standard, Fine, SuperFine, Photo, color fax) S-1
- Ring Delay 4-3
- Rings, setting number of 6-2
- RJ11 Jack 2-12
- Roll Over Phone Lines 2-12

S

- Safety Instructions 23-3
- Scanner, cleaning 24-12
- Scanning into PC 18-5
 - OCR 18-3

- ScanSoft™ PaperPort® 18-1
- Search 8-6
- Sequential Polling Receive 6-7
- Set 1-3, 1-4
- Setup
 - date and time 5-1
 - station ID (fax header) 5-1
- Shift 1-3, 1-4
- Shipping the machine 24-10
- Single Color (One Color) 11-8
- Software
 - installing
 - iMac™/Macintosh 22-2
 - Windows®Parallel 14-2
 - Windows®USB 14-17
 - using
 - Brother Control Center 17-1
 - ScanSoft™ Paper Port® 18-1
- Speaker
 - Low/High 1-4
 - Speaker Phone 1-3, 1-4
 - Volume 5-5
- Special Characters 5-3
- Speed Dial 1-3, 1-4
 - changing 8-3
 - dialing 8-5
 - storing 8-2
- Standard Resolution 7-2
- Station ID 1-2, 5-2, 7-9
 - Federal regulation 5-3

T

- TAD (Telephone Answering Device) 1-5, 2-11, 2-13, 2-14, 6-1
- TAD (Telephone Answering Device) external
 - Connecting 2-10
 - receive mode 6-1
- Telephone Answer Code 6-5, 6-6
 - Fax codes 6-5
- Telephone Index (Tel-index) 1-3, 1-4
- Temporary Copy Settings 11-2
- Temporary Cover Page 7-7
- Temporary Video Print Settings 12-2

Test Print 2-9, 4-5, 24-8
Text entering 5-2
TextBridge[®] OCR 18-1
the Bi-directional
 Windows[®] 95, 98, 98SE and ME 14-4
Tone Signals on Pulse Line 8-8
Transmission Verification (Xmit) Report
10-1, 10-2
Triplex adapter 2-13
Troubleshooting 24-1
 document Jam 24-3
 error messages on LCD 24-2
 if you are having difficulty 24-6
 incoming Calls 24-7
 phone line difficulty 24-6
 printer difficulties 24-7
 printing or receiving faxes 24-6
 sending faxes 24-6
 Video Capture 24-7
 machine 24-1
Two-Line Phone System 2-12, 2-13,
2-14
 converting wall jacks 2-13

U

USB Cable 14-17
 Windows[®] 2000 Professional 14-24
 Windows[®] 98, 98SE, ME 14-18
User Settings 10-1
Using the Options Key 11-4

V

Vertical Alignment 2-9
Video
 Auto Switch 12-1
 Black & White 12-2
 Color 12-2
 Printing 12-1
Video Capture from the PC
 Capturing An Image 18-10
 Connecting Your Video Equipment
 18-10

Video Printing (walk-up) 12-1
 Black & white 12-2
 Color 12-2
 Color Adjustment 12-7
 Contrast 12-8
 Quality 12-6
Video Type 12-3, 12-6
Voice calls
 FAX/TEL (double ring) 6-3
Volume, setting
 beeper 5-3
 handset 5-4
 amplify 5-5
 ring 5-5
 speaker 5-5

W

Warranties
 Canada vi
 USA iv
Windows[®] 2000 Professional 14-8
Windows[®] 95, 98, 98SE, ME, 2000
Professional or NT[®] WS 4.0 14-2
World Wide Web i, 24-1

Y

Yellow shipping cover 2-7

Remote Retrieval Access Card

If you plan to receive fax messages while away from your machine, carrying the Remote Retrieval Access Card printed below will serve as a convenient reminder of the retrieval procedures. Simply cut out the card and fold it to fit your wallet or organizer. Keeping it handy will help you derive the full benefit of your machine's forwarding, paging and remote retrieval features.

REMOTE RETRIEVAL ACCESS CARD

CHECK RECEIVING STATUS
Press **971**
1 long beep — Fax message(s)
3 short beeps — No messages

CHANGE ANSWER MODE
Press **98**
then for TAD, press **1**.
FAX/TEL (Fax/Telephone), press **2**.
FAX, press **3**.

EXIT REMOTE OPERATION
Press **90**.

Using Remote Retrieval Access Code

1 Dial your fax number from a fax machine using touch tone.
2 When your MFC answers, immediately enter your Remote Retrieval Access Code (159✳).
3 Your MFC signals the kinds of messages received:
1 long beep — Fax message(s)
No beeps — No messages.
4 After 2 short beeps, enter a command.
5 Press **90** to reset your MFC when you finish.
6 Hang up.

Fold → ← Fold

1

4

Changing Remote Retrieval Access Code

- 1 Press **Function, 1, 8, 3**
- 2 Enter a three-digit number from 000 to 999.
The * cannot be changed.
- 3 Press **Set**.
- 4 Press **Stop** to exit.

Remote Commands

CHANGE PAGING/FAX FORWARDING SETTING

- Press **9 5**.
then to Turn feature off, press **1**.
Select Fax Forwarding, press **2**.
Select Paging, press **3**.

Program Fax Forwarding Number, press 4

- Enter the new fax number where you want your fax messages forwarded, and press **##**. To retrieve a Memory Status List to check the new number, after two short beeps, press **9 6 1**. Enter the number of the remote fax machine, and press **##**.
Turn Fax Storage on, press **6**.
Turn Fax Storage off, press **7**.

RETRIEVE A FAX

- Press **9 6**
then to Print a Memory Status List, press **1**
then enter the number of remote fax machine, and press **##**. After the beep, hang up and wait.
Retrieve all faxes, press **2**.
then enter the number of remote fax machine, and press **##**. After the beep, hang up and wait.
Erase all fax messages, press **3**.

EQUIPMENT ATTACHMENT LIMITATIONS (For Canada Only)

NOTICE:

The industry Canada label identifies certified equipment. This certification means that the equipment meets telecommunications network protective, operational and safety requirements as prescribed in the appropriate Terminal Equipment Technical Requirements document(s). The Department does not guarantee the equipment will operate to the user's satisfaction.

Before installing this equipment, users should ensure that it is permissible to be connected to the facilities of the local telecommunications company. The equipment must also be installed using an acceptable method of connection. The customer should be aware that compliance with the above conditions may not prevent degradation of service in some situations.

Repairs to certified equipment should be coordinated by a representative designated by the supplier. Any repairs or alterations made by the user to this equipment, or equipment malfunctions, may give the telecommunications company cause to request the user to disconnect the equipment.

Users should ensure for their own protection that the electrical ground connections of the power utility, telephone lines and internal metallic water pipe system, if present, are connected together.

This precaution may be particularly important in rural areas.

Caution:

Users should not attempt to make such connections themselves, but should contact the appropriate electric inspection authority, or electrician, as appropriate.

NOTICE:

The Ringer Equivalence Number (REN) assigned to each terminal device provides an indication of the maximum number of terminals allowed to be connected to a telephone interface. The termination on an interface may consist of any combination of devices subject only to the requirement that the sum of the Ringer Equivalence Numbers of all the devices does not exceed 5 REN=0.2B

brother®

Brother International Corporation
100 Somerset Corporate Boulevard
P.O. Box 6911
Bridgewater, NJ 08807-0911 USA

Brother International Corporation (Canada) Ltd.
1 rue Hôtel de Ville,
Dollard-des-Ormeaux, QC, CANADA H9B 3H6

**Visit us on the World Wide Web
<http://www.brother.com>**

These machines are made for use in the USA and CANADA only. We cannot recommend using them overseas because it may violate the Telecommunications Regulations of that country and the power requirements of your Multi-Function Center may not be compatible with the power available in foreign countries. **Using USA or CANADA models overseas is at your own risk and will void your warranty.**