

OWNER'S MANUAL

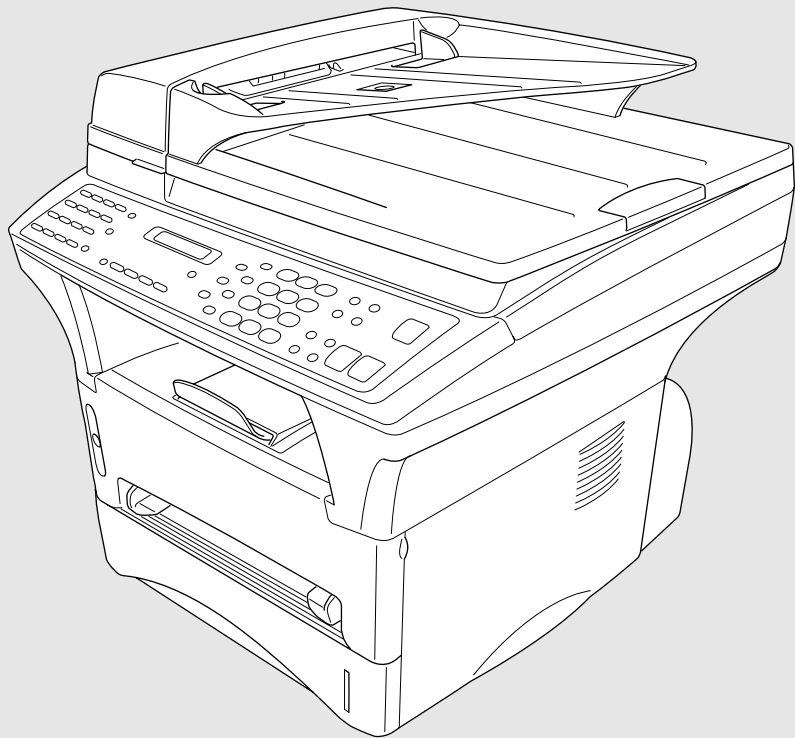

MFC 9600

.....

brother
At your side.

If You Need to Call Customer Service

Please complete the following information for future reference:

Model Number: MFC 9600

Serial Number:* _____

Date of Purchase: _____

Place of Purchase: _____

* The serial number is on the back of the unit. Retain this manual with your *sales receipt* as a permanent record of your purchase, in the event of a theft, fire or warranty service.

Year 2000 Compliant

Brother is addressing the Year 2000 related issues for all Brother fax machines and multi-function centers. Our focus is to ensure that our bundled third-party software will continue to properly process date/time data after January 1, 2000.

Brother fax machines and multi-function centers will function properly after January 1, 2000, *provided that* all non-Brother hardware, software and firmware used by our customers in connection or combination with Brother fax machines, MFCs and bundled software, accurately exchange date data with the Brother products.

Please continue to check our Web page for updates at **<http://www.brother.com>**. All remedies will be provided to individual customers via software patches through software download or from Brother Customer Service.

Brother Numbers

Brother fax-back system

Brother Customer Service has installed an easy-to-use fax-back system, so you can get instant answers to common technical questions and product information for all Brother products. This system is available 24 hours a day, 7 days a week. You can use the system to send faxes to any fax machine, not just the one from which you are calling.

If you can't resolve a difficulty with your MFC using this manual, call our fax-back system, and follow the voice prompts to receive faxed instructions about using the system and an index of fax-back subjects.

USA: 1-800-521-2846

From within Canada: 1-800-681-9838

The Brother fax-back system number (USA Only) has been preprogrammed on One Touch key .

Frequently Asked Questions (FAQs)

You can find more information about Brother products on the World Wide Web. From product specification sheets to Frequently Asked Questions (FAQs), it is all there. Visit us at:

<http://www.brother.com>

Brother Bulletin Board

Brother's Bulletin Board Numbers are

USA: 1-888-298-3616

From within Canada: 1-514-685-2040

For Customer Service

USA: 1-800-284-4329 (voice)
1-908-575-8790 (fax)

From within Canada: 1-800-853-6660 (voice)
1-514-685-4898 (fax)

From within Montreal: 1-514-685-6464 (voice)

Ordering Accessories and Supplies

For best quality results use only genuine Brother accessories, available at most Brother retailers. If you cannot find the accessory you need and you have a Visa, MasterCard, Discover, or American Express credit card, you can order accessories directly from Brother. (In the USA, you can visit us online for a complete selection of Brother accessories and supplies available for purchase.)

USA: 1-888-879-3232 (voice)
 1-800-947-1445 (fax)
<http://www.brothermall.com>

From within Canada: 1-800-668-2768 (voice)

Description	Item
Laser Fax Toner	TN-430 (Able to print 3000 pages) TN-460 (Able to print 6000 pages)
Laser Fax Drum	DR400
* 8 MB Expandable Memory Board	ME8000
* 16 MB Expandable Memory Board	ME16000
Telephone Line Cord	UG3565001
IEEE-1284 Bi-directional Cable	F2A046-10
Multi-purpose Paper Cassette #2	LT400
Power Protector for A/C Power and Phone Line Surges and Voltage Spikes	QPD120
Multi-purpose Paper Cassette #2	LT400
Network (LAN) Board	NC8000
Quick Reference Card	LE1228001
Owner's Manual	LE1226001
** Multi-Function Link® Pro software on Floppy Disks includes MFL Pro and ScanSoft™ PaperPort® only	PCI4D31 (Floppy Disks, Windows® 3.1x) PCI4D95 (Floppy Disks, Windows® 95/98)

* Before you install ME8000 or ME16000, be sure to read DISCLAIMER—USER INSTALLATION OF MEMORY BOARD(S), page iii.

** Multi-Function Link® Pro Software is not available on Floppy Disks for Windows NT® Workstation Version 4.0.

Notice – Disclaimer of Warranties **(For USA and Canada)**

BROTHER'S LICENSOR(S), AND THEIR DIRECTORS, OFFICERS, EMPLOYEES OR AGENTS (COLLECTIVELY BROTHER'S LICENSOR) MAKE NO WARRANTIES, EXPRESS OR IMPLIED, INCLUDING WITHOUT LIMITATION THE IMPLIED WARRANTIES OF MERCHANTABILITY AND FITNESS FOR A PARTICULAR PURPOSE, REGARDING THE SOFTWARE. BROTHER'S LICENSOR(S) DOES NOT WARRANT, GUARANTEE OR MAKE ANY REPRESENTATIONS REGARDING THE USE OR THE RESULTS OF THE USE OF THE SOFTWARE IN TERMS OF ITS CORRECTNESS, ACCURACY, RELIABILITY, CURRENTNESS OR OTHERWISE. THE ENTIRE RISK AS TO THE RESULTS AND PERFORMANCE OF THE SOFTWARE IS ASSUMED BY YOU. THE EXCLUSION OF IMPLIED WARRANTIES IS NOT PERMITTED BY SOME STATES IN THE USA AND SOME PROVINCES IN CANADA. THE ABOVE EXCLUSION MAY NOT APPLY TO YOU.

IN NO EVENT WILL BROTHER'S LICENSOR(S) BE LIABLE TO YOU FOR ANY CONSEQUENTIAL, INCIDENTAL OR INDIRECT DAMAGES (INCLUDING DAMAGES FOR LOSS OF BUSINESS PROFITS, BUSINESS INTERRUPTION, LOSS OF BUSINESS INFORMATION, AND THE LIKE) ARISING OUT OF THE USE OR INABILITY TO USE THE SOFTWARE EVEN IF BROTHER'S LICENSOR HAS BEEN ADVISED OF THE POSSIBILITY OF SUCH DAMAGES. BECAUSE SOME STATES IN THE USA AND SOME PROVINCES IN CANADA DO NOT ALLOW THE EXCLUSION OR LIMITATION OF LIABILITY FOR CONSEQUENTIAL OR INCIDENTAL DAMAGES, THE ABOVE LIMITATIONS MAY NOT APPLY TO YOU. IN ANY EVENT BROTHER'S LICENSOR'S LIABILITY TO YOU FOR ACTUAL DAMAGES FROM ANY CAUSE WHATSOEVER, AND REGARDLESS OF THE FORM OF THE ACTION (WHETHER IN CONTRACT, TORT (INCLUDING NEGLIGENCE), PRODUCT LIABILITY OR OTHERWISE), WILL BE LIMITED TO \$50.

Disclaimer—User Installation of Memory Board(s)

In some cases, product may be modified by adding and/or replacing the memory board(s) with approved replacements. Any damage to the product, the memory board(s) to be inserted therein or otherwise, caused as a result of improper installation (including installation of other than approved memory boards(s)) is not covered by the Limited Warranty. If you do not feel comfortable with the installation of approved memory board(s), contact a Brother Authorized Service Center to perform the installation of the memory board(s) for you. If you elect to use a Brother Authorized Service Center, you will be responsible for a moderate service charge. For the name and location of a convenient Authorized Service Center, please call 1-800-521-2846.

BROTHER ONE YEAR LIMITED WARRANTY and EXCHANGE SERVICE (For USA Only)

This warranty gives you certain rights and you may also have other rights that may vary from state to state.

This warranty is given only to the end-use purchaser of the accompanying product (referred to in this warranty as "this Product").

What is covered: Brother warrants to you for the Warranty Period that there are no defects in the materials, workmanship or Year 2000 compliance of this Product. The "Warranty Period" is 1 year from the date you purchased this product. The "Warranty Period" for consumable items, such as Toner, Drums, etc. is 90 days from the date of purchase, or the rated life of the Consumable item, whichever is shorter.

What is NOT covered: This warranty is VOID — that is, this Product has no warranty — if: (1) you did not purchase this Product from an authorized Brother reseller within the United States, (2) this Product has been serviced, modified or tampered with by anyone other than an Authorized Service Representative of Brother, (3) the serial number has been modified, defaced or removed from this Product, (4) this Product has been abused or damaged, (5) non Brother®-brand or non Brother approved parts, supplies, power supplies or other accessories have been used with this Product, or (6) this Product has been transported without the proper preparation and packaging.

What to do if you think your Product is defective:

Call our Customer Service Hotline at 1-800-284-4329, or if you suspect a defect in materials or workmanship in this Product, you can report it to a Brother Authorized Service Center. During the Warranty Period, supply Brother's representative with a copy of your dated bill of sale showing that this Product was purchased within the United States.

For the name of your Brother Authorized Service Center, call 1-800-521-2846. After contacting the Brother Authorized Service Center, you may be required to deliver or send the Product properly packaged, freight prepaid, to the Authorized Service Center together with a photocopy of your bill of sale.

What Brother will do: Brother (or its Authorized Service Center) will evaluate your report of a possible defect to determine whether a defect exists, and if it does exist, Brother (or its Authorized Service Center) will repair or (at Brother's option) replace the Product with a product that performs the same functions and performs as well as the original Product. Brother reserves the right to supply refurbished or remanufactured replacement products provided that the replacement products conform to the manufacturer's specifications for new products. The repaired or replacement product will be returned to you at no cost.

Exchange Service:

Exchange service will expedite, in most instances by the next business day, the exchange of your non working Product with a refurbished or remanufactured product that conforms to the manufacturer's specifications for new products. The refurbished or remanufactured Product you receive will be covered by the balance of the limited warranty period remaining on the original Product, plus an additional thirty (30) days. You will keep the replacement Product that is sent to you and must return (or be billed up to the cost of a new product) your original non working product, which shall become the property of Brother. You must call Brother Customer Service and if the representative cannot correct the product's malfunction over the telephone and you elect the exchange service, you must provide information pertaining to this Product and you must also provide a valid major credit card number. Your credit card will be charged up to the cost of a new

BROTHER ONE YEAR LIMITED WARRANTY and EXCHANGE SERVICE (For USA Only)

Product if: (i) you do not return your original Product to Brother within five (5) business days; (ii) the malfunctions of your original Product are not covered by the limited warranty; (iii) the proper packaging instructions are not followed and has caused damage to the product; or (iv) the warranty period on your original Product has expired or has not been sufficiently validated with a copy of the proof of purchase (bill of sale). The Brother Customer Service Representative will ship the exchange Product via next business day delivery courier service, with return instructions and prepaid return airbill.

Follow the return instructions. You must return the original Product in the same shipping carton in which the exchanged Product was received and include a copy of proof of purchase (bill of sale). Retain your original accessory items and a copy of the return airbill, signed by the courier.

Limitations:

Repair or replacement as described above is your sole and exclusive (that is, your only) remedy if this Product is defective. Brother is not responsible for damage to or loss of any equipment, media, programs or data related to the use of this Product. Except for that repair or replacement, *Brother shall not be liable for any direct, indirect, incidental or consequential damages or specific relief. Because some states do not allow the exclusion or limitation of consequential or incidental damages, the above limitation may not apply to you.*

THIS WARRANTY IS GIVEN IN LIEU OF ALL OTHER WARRANTIES, WRITTEN OR ORAL, WHETHER EXPRESSED BY AFFIRMATION, PROMISE, DESCRIPTION, DRAWING, MODEL OR SAMPLE. ANY AND ALL WARRANTIES OTHER THAN THIS ONE, WHETHER EXPRESS OR IMPLIED, INCLUDING IMPLIED WARRANTIES OF MERCHANTABILITY AND FITNESS FOR A PARTICULAR PURPOSE, ARE HEREBY DISCLAIMED.

This Limited Warranty is the only warranty that Brother is giving for this Product. It is the *final expression and the exclusive and only statement* of Brother's obligations to you. It replaces all other agreements and understandings that you may have with Brother or its representatives.

This Limited Warranty (and Brother's obligation to you) may not be changed in any way unless you and Brother sign the same piece of paper in which we (1) refer to this Product and your bill of sale date, (2) describe the change to this warranty and (3) agree to make that change.

Product Support: Toll-free customer service and technical support is available for hardware operational assistance at [1-800-284-4329](tel:1-800-284-4329). At any time, free technical support in the form of Frequently Asked Questions, troubleshooting tips and service center locator is available through our fax back system at [1-800-521-2846](tel:1-800-521-2846) or Brother's Internet Web Site (www.brother.com). Now you can visit us on-line (www.brothermall.com), your complete source for genuine Brother Accessories and Supplies.

**BROTHER INTERNATIONAL CORPORATION
100 SOMERSET CORPORATE BLVD.
BRIDGEWATER, NEW JERSEY 08807-0911**

Please record your model and serial number and your date and location of Purchase below for your records. Keep this information with your proof of purchase (bill of sale) in case your Product is lost, stolen or requires service.

Model #

Serial #

Date of purchase:

Store where purchased:

Location of store:

Important: We recommend that you keep all original packing materials, in the event that you ship this product.

**BROTHER MULTIFUNCTION CENTER/FACSIMILE MACHINE
LIMITED WARRANTY
(For Canada Only)**

Pursuant to this limited warranty of 1 year from the date of purchase for labour and parts, Brother International Corporation (Canada) Ltd. ("Brother"), or its Authorized Service Centers, will repair this MFC/Facsimile machine free of charge if defective in material or workmanship. This Limited Warranty does not include cleaning, consumables (including, without limitation, print cartridges, print head, toner and drum) or damage caused by accident, neglect, misuse or improper installation or operation, any damage caused from service, maintenance, modifications, or tampering by anyone other than a Brother Authorized Service Representative, or from the use of supplies or consumable items that are non-Brother products. Operation of the MFC/Facsimile machine in excess of the specifications or with the Serial Number or Rating Label removed shall be deemed abuse and all repairs thereafter shall be the sole liability of the end-user/purchaser. In order to obtain warranty service, the MFC/Facsimile machine must be delivered or shipped freight prepaid by the end user/purchaser to a "Brother" Authorized Service Center, together with your Proof of Purchase in the form of a Sales Receipt.

For laser products: Failure to remove the Toner Cartridge (and Toner Drum Unit on applicable models) during shipping will cause severe damage to the MFC/Facsimile and will VOID the Warranty. (Refer to your Operation Manual for proper packaging.)

For ink-jet products: Do not remove the ink cartridges during shipping. Damage to your print head resulting from packing without the ink cartridges will VOID your warranty. (Refer to your Operation Manual for proper packaging.)

BROTHER DISCLAIMS ALL OTHER WARRANTIES EXPRESSED OR IMPLIED INCLUDING, WITHOUT LIMITATION, ANY IMPLIED WARRANTIES OF MERCHANTABILITY OR FITNESS FOR A PARTICULAR PURPOSE, EXCEPT TO THE EXTENT THAT ANY WARRANTIES IMPLIED BY LAW CANNOT BE VALIDLY WAIVED.

No oral or written information, advice or representation provided by Brother, its Authorized Service Centers, Distributors, Dealers, Agents or employees, shall create another warranty or modify this warranty. This warranty states Brother's entire liability and your exclusive remedy against Brother for any failure of the MFC/Facsimile machine to operate properly.

Neither Brother nor anyone else involved in the development, production, or delivery of this MFC/Facsimile machine shall be liable for any indirect, incidental, special, consequential, exemplary, or punitive damages, including lost profits, arising from the use of or inability to use the product, even if advised by the end user/purchaser of the possibility of such damages. Since some Provinces do not allow the above limitation of liability, such limitation may not apply to you.

This Limited Warranty gives you specific legal rights and you may also have other rights which vary from Province to Province.

Warranty Service is available at Brother Authorized Service Centers throughout Canada. For Technical Support or for the name and location of your nearest Authorized Service Center call 1-800-853-6660. Within Montreal, please call 685-6464. Internet support: support@brother.ca or browse Brother's Web Site: www.brother.com

Brother International Corporation (Canada) Ltd.
1 Rue Hôtel de Ville
Dollard-Des-Ormeaux, QC H9B 3H6

We're at your side.
brother®

Table of Contents

1	Introduction	1-1
	Using This Manual	1-1
	Finding Information	1-1
	Test Sheet Procedures (For USA Only)	1-1
	MFC 9600 Control Panel Overview	1-2
	About Fax Machines	1-4
	Fax Tones and Handshake	1-4
	ECM (Error Correction Mode)	1-4
2	Assembly and Connections	2-1
	Packing List	2-1
	Make sure you have the following items:	2-1
	Choosing a Location	2-2
	IMPORTANT SAFETY INSTRUCTIONS	2-3
	Release the Scanner Lock	2-3
	Assembly	2-4
	Installing the Drum Unit Assembly (with Toner Cartridge)	2-4
	Paper	2-5
	Acceptable Paper	2-5
	Paper Capacity of Paper Cassette	2-5
	Paper Specification for the Cassette	2-6
	Manual Feed Slot	2-6
	Loading Paper in Multi-purpose Paper Cassette	2-6
	Manual Feed Slot	2-7
	Connecting the MFC	2-8
	Connections	2-9
	Connecting an External Telephone	2-9
	Connecting an External TAD (Telephone Answering Device)	2-9
	Sequence	2-9
	Connections	2-9
	Recording Outgoing Message (OGM)	2-10
	Special Line Considerations	2-11
	Roll Over Phone Lines	2-11
	Two-Line Phone System	2-11
	Converting Telephone Wall Outlets	2-11
	Installing MFC, External Two-Line TAD, and Two-Line Telephone	2-12
	Multi-Line Connections (PBX)	2-13
	If you are installing the MFC to work with a PBX:	2-13
	Custom Features on a Single Line	2-13

3	On-Screen Programming	3-1
	User-Friendly Programming	3-1
	Function Mode	3-1
	Function Selection Table	3-2
4	Initial Setup	4-1
	Getting Started	4-1
	Setting Dialing Mode (Tone/Pulse)	4-1
	Setting Date and Time	4-1
	Setting Station ID	4-2
	Entering Text	4-2
	Setting Beeper Volume	4-3
	Speaker Volume	4-4
	Ring Volume	4-4
	Memory Storage	4-4
	Sleep Mode	4-4
	Delayed Timer	4-5
	Turning On Automatic Daylight Savings Time	4-5
5	Setup Receive	5-1
	Basic Receiving Operations	5-1
	Setting or Changing the Answer Mode	5-1
	Setting Ring Delay	5-2
	Easy Receive	5-2
	Turning on Cassette #2	5-2
	Printing a Reduced Incoming Document	5-3
	Recommended Reductions	5-3
	Setting Paper Size	5-3
	Setting Cassette Usage	5-4
	Setting the Print Density	5-4
	Toner Save	5-4
	Advanced Receiving Operations	5-5
	Operation from Extension Telephones	5-5
	Changing the Fax Receive Code	5-5
	Printing a Fax in Memory	5-5
	Polling	5-6
	Setting Up Polling Receive	5-6
	Setting Up Sequential Polling Receive	5-6
	Canceling a Scheduled Job	5-7
	Telephone Services	5-7
Distinctive Ring	5-7	
Registering your Distinctive Ring Pattern	5-8	
Caller ID	5-9	
Viewing Caller ID List	5-9	
Printing Caller ID List	5-9	
Clearing a Caller ID Stored in Memory	5-10	

6	Setup Send	6-1
	Before You Begin	6-1
	Sending Faxes Using Multiple Settings	6-1
	Faxing from the ADF (Automatic Document Feeder)	6-1
	Faxing from the Scanner Glass	6-3
	Resolution	6-4
	Contrast	6-4
	Automatic Transmission	6-4
	Manual Transmission	6-5
	Manual and Automatic Fax Redial	6-5
	Dual Access	6-5
	Real Time Transmission	6-6
	Checking the Jobs Status	6-6
	Canceling Jobs in Memory	6-7
	Basic Sending Operations	6-7
	Composing Electronic Cover Page	6-7
	Composing Your Own Comments	6-8
	Cover Page for Next Fax Only	6-8
	Always Send Cover Page	6-9
	Using a Printed Cover Page	6-9
	Advanced Sending Operations	6-10
Overseas Mode	6-10	
Delayed Fax	6-10	
Delayed Batch Transmission	6-11	
Multiple Resolution Transmission	6-11	
Setting Up for Polling Transmit	6-12	
7	Auto Dial Numbers and Dialing Options	7-1
	Storing Numbers for Easy Dialing	7-1
	Storing One Touch Dial Numbers	7-1
	Storing Speed Dial Numbers	7-2
	Changing One Touch and Speed Dial Numbers	7-2
	Setting Up Groups for Broadcasting	7-3
	Dialing Options	7-4
	Searching Telephone Index	7-4
	One Touch Dialing	7-4
	Speed Dialing	7-4
	Pause	7-4
	Fax Redial	7-4
	Broadcasting	7-5
Dialing Access Codes and Credit Card Numbers	7-6	

8	Remote Fax Options	8-1
	Paging and Fax Forwarding	8-1
	Programming a Paging Number	8-1
	Programming a Fax Forwarding Number	8-2
	Setting Fax Storage	8-2
	Remote Retrieval	8-3
	Changing Remote Retrieval Access Code	8-3
	Using Remote Retrieval Access Code	8-3
	Remote Commands	8-4
	Retrieving Memory Status List	8-5
Retrieving Fax Messages	8-5	
Changing Fax Forwarding Number Remotely	8-6	
9	Printing Reports	9-1
	MFC Settings and Activity	9-1
	To Print a Report	9-1
	Transmission Verification (Xmit) Report	9-2
Activity Report Interval	9-2	
10	Making Copies	10-1
	Basic Copy Operations	10-1
	Copying One Page	10-1
	Stacking Multiple Copies (Using the ADF)	10-1
	Sorting Multiple Copies (Using the ADF)	10-1
	Single or Multiple Copies (Using the Scanner Glass)	10-2
	Memory Full Message	10-3
	Copy Options (Temporary Settings)	10-3
	Copy Contrast	10-3
	Document type	10-4
	Enlarged or Reduced Copies	10-4
	Special Copy Options	10-4
	4in1	10-5
	2in1	10-5
	Poster	10-5
11	Walk-Up Video Printing	11-1
	Getting Started	11-1
	Setting Up Video Print Mode	11-2
	Black and White Video Printing	11-2
	Changing Default Settings	11-3
	Setting Video Printing Quality	11-3
	Setting Video Type	11-4
	Setting Print Size	11-4
Video Capture from the PC	11-4	

12

Setting Up the Brother MFC and PC to Work Together	12-1
Using the Brother Machine with Your PC	12-1
Before You Install Multi-Function Link® Pro	12-1
If You Don't Have a CD-ROM Drive	12-1
Computer Requirements	12-2
Using a USB Cable to Connect the MFC to the PC (Using Windows® 98 Only)	12-2
Installing Brother Software Using a USB Cable	12-4
Using the Bundled Parallel Cable to Connect the MFC to the PC	12-10
Choosing the Software to Install	12-11
Install Multi-Function Link® Pro	12-11
Install Printer and Scanner Drivers Only	12-11
Install NetCentric™ FaxStorm	12-11
Install Automatic E-Mail Printing	12-11
View Online Documentation	12-11
View Product Support Information	12-11
Brother Web Link	12-11
Exit	12-11
Installing the Brother Software (For Parallel Interface)	12-12
Overview of Basic Steps	12-12
Helpful Hints for Windows® 3.1x or Windows® 95/98	12-14
Receiving Messages into the PC	12-15
Multi-Function Link® Pro Mode	12-15

13

For DOS Users	13-1
How to Use Brother Machine with Your DOS Application Software	13-1
What Does the Remote Printer Console Do?	13-1
Remote Printer Console Main Program	13-1
Printer Status Monitor Program	13-2
Installing the Remote Printer Console	13-2
Using the Remote Printer Console Main Program	13-3
Remote Printer Console	13-4
Current Printer Status Information	13-4
Printer Setup Category	13-4
Print Setup Section	13-4
Page Setup Section	13-5
Font Configuration	13-5
Other Configuration	13-6
Console Configuration Category	13-6
Using the Printer Status Monitor Program	13-7

14

- Using the Brother MFC as a Printer** 14-1
- Special Printing Features** 14-1
 - Windows® Printing 14-1
 - Popular Printer Emulation Support 14-1
 - Remote Printer Console Program for DOS 14-1
 - Bi-directional Parallel Interface 14-1
 - Enhanced Memory Management 14-1
- Printing From Your PC** 14-2
 - Multi-purpose Paper Cassette 14-2
 - Two-Sided Printing (Manual Duplexing) 14-2
 - Front Output Bin 14-3
 - Manual Feed Slot 14-3
 - Loading One Sheet of Paper 14-4
 - Loading More than One Sheet of Paper 14-4
 - Printing on Thicker Paper and Card Stock 14-5
- Simultaneous Printing/Faxing** 14-6
 - Choosing Acceptable Paper 14-6
- Printer Operation Keys** 14-7
 - On/Off Line Key 14-7
 - FF/Cont Key 14-7
 - Print Priority Key 14-7
 - Test/Reset Key 14-7
 - Printing the Internal Font List 14-8
 - Printing the Print Configuration List 14-8
 - Restoring Factory Default Settings 14-8
 - Printing PC Data in Hexadecimal 14-8

15

- Using the Windows® Based Brother Control Center
(For Windows® 95/98 and NT® 4.0 Only)** 15-1
- Brother Control Center** 15-1
 - AutoLoad the Brother Control Center 15-2
 - How to Turn Off AutoLoad 15-2
- Brother Control Center Features** 15-3
 - Auto Configuration 15-3
 - Scanning Operations 15-3
 - Copy Operations 15-4
 - PC Fax Operation 15-4
 - Scanner Settings for Scan, Copy and PC Fax Buttons 15-4
 - Global Settings 15-5
 - Setting Up the Scanner Configurations 15-5
 - To access the Scanner Configurations screen: 15-5
 - Perform an Operation from the Control Center Screen 15-6
- Scan to File** 15-6
 - Scanner Settings 15-6
 - Destination Folder 15-6
- Send Scan to E-mail** 15-8
 - Scanner Settings 15-8
 - Email Application 15-8

File Attachments	15-9
Conversion Options	15-9
Show QuickSend Menu	15-9
QuickSend List	15-10
Send Scan to Word Processor	15-11
Scanner Settings	15-11
Word Processor	15-11
User Defined Button	15-13
Scanner Settings	15-13
Target Application	15-13
Copy / Two on One Copy	15-14
Scanner Settings	15-14
Copy Settings	15-14
Send a Fax	15-15
Scanner Settings	15-15
FAX Settings	15-16

16

Using Multi-Function Link® Pro Software	16-1
Introduction	16-1
Brother Resource Manager	16-1
MFC Remote Setup	16-2
Multi-Function Link® Pro Main Menu	16-3
Sending a Fax from Your PC	16-3
Sending a Quick Fax	16-3
Sending a Fax from the Main Menu	16-4
Sending a Fax from a Windows® Application	16-4
Receiving Faxes into the PC	16-5
Checklist for the MFC	16-5
Checklist for Your PC	16-5
Viewing Received Faxes	16-6

17

Using ScanSoft™ PaperPort® for Brother/TextBridge®	17-1
Using the Scan Keys	17-1
Using the Control Panel Keys (For Windows® 95/98 and Windows NT® 4.0 Only)	17-1
Scan Image	17-1
Scan/OCR	17-2
Scan to E-mail	17-2
Using ScanSoft™ PaperPort® and TextBridge®	17-3
Viewing Items in ScanSoft™ PaperPort®	17-4
Organizing Your Items in Folders	17-4
Links to Many Other Applications	17-5
Using ScanSoft™ TextBridge® OCR (Converting Image Text to Text You Can Edit)	17-5
Importing Items from Other Applications	17-6
Exporting Items in Other Formats	17-6
Scanning a Document	17-6
TWAIN COMPLIANT	17-6

Accessing the Scanner	17-7
Scanning a Document into the PC	17-7
Settings in the Scanner Window	17-8
Resolution:	17-8
Color Type:	17-8
Size:	17-9
Custom:	17-9
Adjust:	17-9
Paper:	17-9
Video Capture:	17-9
PreScanning an Image	17-10
How to use PreScan to adjust an image:	17-10
Video Capture from the PC	17-12
Connecting Your Video Equipment	17-12
To connect your video equipment:	17-12
Capturing An Image	17-12
To capture a frame as an image:	17-13

18

Using Internet Faxing with NetCentric™ FaxStorm	18-1
Internet Faxing (For Windows® 3.1 / 95/98 /NT® 4.0 Only)	18-1
To Look for Software Updates at www.brother.com	18-2
To Access the On-Line Documentation	18-2
Customer Support	18-2

19

Using Automatic E-Mail Printing	19-1
For Windows® 95/98 Only	19-1
Main Features	19-1
To Look for Software Updates at www.brother.com	19-2
To Access the On-Line Documentation	19-2

20

Optional Accessories	20-1
Additional Memory for Faxing/Printing	20-1
For the Printer	20-1
For the Fax	20-1
Paper Cassette #2 (Option)	20-2
Network (LAN) Board	20-2

21	Important Information	21-1
	Standard Telephone and FCC Notices	
	(For 120V Models Only)	21-1
	These notices are in effect on models sold and used in the United States only.	21-1
	Federal Communications Commission (FCC) Declaration of Conformity (For USA Only)	21-2
	ENERGY STAR® Compliance Statement	21-2
	Important—About the Interface Cable	21-3
	Industry Canada Compliance Statement (For Canada Only)....	21-3
	Laser Safety (For 110-120V Models Only)	21-3
	FDA Regulations	21-3
	Manufacturing Information	21-3
	Important Safety Instructions	21-4
	Compilation and Publication Notice	21-6
	Trademarks	21-6
22	Troubleshooting and Routine Maintenance	22-1
	Troubleshooting	22-1
	Brother fax-back system	22-1
	Frequently Asked Questions (FAQs)	22-1
	Brother Bulletin Board	22-1
	Error Messages	22-1
	Document Jams and Paper Jams	22-4
	Document Jam in the Top of the ADF Unit	22-4
	Document Jam Inside the ADF Unit	22-5
	Printer Jam	22-5
	Paper is jammed in the Multi-purpose Paper Cassette	22-6
	Paper is jammed near the Drum Unit	22-6
	Paper is jammed in the Fuser Unit	22-6
	If You Are Having Difficulty with Your MFC	22-7
	Packing and Shipping the MFC	22-14
	Look the Scanner Lock	22-14
	Routine Maintenance	22-17
	Cleaning the Scanner	22-17
	Cleaning the Printer	22-18
	Cleaning the Drum Unit	22-19
	Replacing the Toner Cartridge	22-19
	Toner Empty Indicator	22-20
	How to Replace the Toner Cartridge	22-20
	Replacing the Drum Unit	22-22
	Checking the Drum Life	22-24
	For Customer Service	22-24

Using the Brother MFC with a New Power Macintosh® G3 or iMac™ 23-1

Connecting Your USB Equipped Apple Macintosh G3 or iMac with Mac OS 8.5/8.6 23-1

Installing the Brother Printer and Scanner Drivers 23-1

Using Brother TWAIN Scanner Driver with Your Apple Macintosh G3 or iMac 23-2

- Importing Images 23-2
- Exporting Images in Other Formats 23-2
- Accessing the Scanner 23-3
- Scanning a Document into Your Macintosh G3 or iMac 23-3
- Settings in the Scanner Window 23-4
 - Image 23-4
 - Scanning Area 23-5
 - Business Card Size 23-5
 - Miscellaneous 23-6
 - Contrast 23-6
 - PreScanning an Image 23-7

Glossary G-1

Specifications S-1

Product Description S-1

Fax Specifications S-1

Printer Specifications S-2

- Parallel Interface Specifications S-3
- USB (Universal Serial Bus) Interface Specifications S-4
- Resident Fonts S-4
- Symbol Sets/Character Sets S-4

Index I-1

Remote Retrieval Access Card R-1

1 Introduction

Using This Manual

Thank you for purchasing a Brother Multi-Function Center (MFC). This MFC has been designed to be simple to use, with LCD screen prompts to guide you through functions. However, you can use your MFC to its fullest potential by taking a few minutes to read this manual.



Additionally, your MFC has a Help Key. Press **[Help]** to print a list of basic operational steps and functions.

Finding Information

All chapter headings and subheadings are listed in the Table of Contents. You will be able to find information about a specific feature or function by checking the Index in the back of this manual. Also, throughout this manual, you'll see special symbols alerting you to important information, cautions to avoid damaging the machine, and warnings to avoid hurting yourself. Illustrations of some screen displays also help you choose the correct key-presses.

Test Sheet Procedures (For USA Only)

After programming your Station ID, please fill out the TEST SHEET included with your MFC and fax it to Brother's Automated Fax Response System as your first transmission. This will verify that your MFC is properly installed. (See *Setting Station ID*, pages 4-2 to 4-3.)

When this document is received, a confirmation sheet will be sent back to your MFC. In order to receive a response, be sure to set up your Station ID.

USA 1-908-685-9283 (fax)

MFC 9600 Control Panel Overview

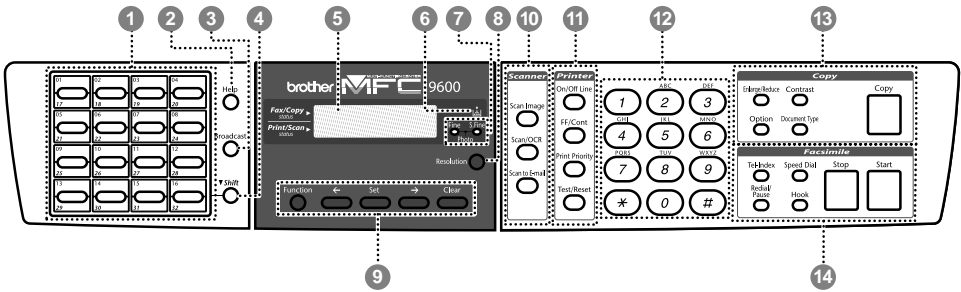

- 1 One Touch Keys**
These 16 keys give you instant access to previously stored phone numbers.
- 2 Help**
Whenever the Date and Time are displayed on the LCD, you can press this key to print a quick reference Help List. The Help List shows how to program functions, register information and how to get basic information.
- 3 Broadcast**
Use this key when you want to broadcast the same fax to many different locations (maximum of 182 locations at once).
- 4 ▼ Shift**
To access memory locations 17 through 32 in the One Touch keys hold down the Shift key.
- 5 LCD (Liquid Crystal Display)**
LCD displays messages to help you set up and operate your MFC.
- 6 Toner Empty Indicator**
Blinks when toner cartridge is low and stays lit when toner is empty.
- 7 Resolution Indicator Lights**
These LEDs show the resolution mode you selected.
- 8 Resolution**
Sets the resolution when you send a fax.

- 9 Programming Keys:**
 - Function**
Lets you access the function and programming mode
 - ← (Left Arrow)**
→ (Right Arrow)
Moves the LCD cursor through text and options.
 - Set**
Stores a function setting in the MFC.
 - Clear**
Deletes entered data or backs up one step in function procedure.
- 10 Scanner Function Keys:**
 - Scan Image**
Press this key to scan a color picture into your graphics application for viewing and editing.
 - Scan/OCR**
Press this key to start scanning a text document. ScanSoft™ TextBridge® will convert it to editable text and display it in your word processor application for further editing.
 - Scan to E-mail**
Press this key to start scanning a an original into your E-mail application, setting it up automatically as an attachment.

11 Printer Function Keys:

On/OffLine

Use this key to turn the printer online (ready to receive PC data) and offline (not ready to receive PC data) alternately. When the printer is online, the LCD displays ONLINE.

FF/Cont

When the LCD shows REMAINED DATA, you can turn the machine OFFLINE and then press this key to print the data that is in the memory. Also, it clears operation and machine errors.

Print Priority

When this key is pressed, all faxes will be received into memory without first printing. They can be printed later.

Test/Reset

This key is used to print a test page. When it is pressed together with Shift, it clears the data from the printer memory and cancels an error status.

12 Dial Pad

Dials phone and fax numbers, and can be used as a keyboard for entering information into the MFC.

13 Copy Function Keys: (Temporary Settings)

Enlarge/Reduce

Use this key to select an enlargement or reduction ratio: 93%, 87%, 75%, 50%, 25%, 100%, 120%, 125%, 141%, 150%, 200%, 400%, AUTO, ZOOM. For more choices, select ZOOM and use the dial pad to type any percentage between 25% and 400%. Select AUTO to automatically fit the original on the selected paper size.

Contrast

Lets you make a copy that is lighter or darker than the original.

Option

You can sort multiple copies using the ADF—**OR**—change the layout of copies on the print media:

4in1 — Save paper by copying four pages onto one page.

2in1 — Save paper or create a booklet by copying two pages onto one page.

Poster — This option copies a different portion of the original on each of nine sheets of print media. Tape the sheets together to get a copy that is nine times the size of the original.

Document type

Lets you choose either AUTO, TEXT or PHOTO.

Copy

Makes a copy.

14 Facsimile Keys:

Tel-index

Lets you look up numbers stored in the dialing memory.

Speed Dial

Lets you dial stored phone numbers by pressing a two-digit number.

Redial / Pause

Redials the last number that was called. Also inserts a pause in autodial numbers.

Hook

Lets you dial fax numbers.

Stop

Stops a fax, cancels an operation, or exits from function mode.

Start

Starts an operation, such as sending a fax.

About Fax Machines

If you're a first-time fax machine user, fax operation might seem a little mysterious. Soon, you'll recognize the unusual fax tones on your phone line, and be able to send and receive faxes easily.

Fax Tones and Handshake

When someone is sending a fax, the MFC sends fax calling tones, (CNG tones)—soft, intermittent beeps at 4-second intervals. You'll hear them when you dial and press **[Start]**, and they continue for about 40 seconds after dialing. During that time, the sending machine must begin the “handshake” with the receiving machine. Each time you use automatic procedures to send a fax, you are sending CNG tones over the phone line. You'll soon learn to listen for these soft beeps each time you answer a phone on your fax line, so you will know if you are receiving a fax message.

The receiving fax responds with fax receiving tones—loud, chirping sounds. A receiving fax chirps for about 40 seconds over the phone line, and the screen displays RECEIVING. If your MFC is set to the FAX mode, it will answer every call automatically with fax receiving tones. Even if the other party hangs up, your MFC continues to send the “chirps” for about 40 seconds, and the screen continues to display RECEIVING.

The fax “handshake” is the time in which the sending machine's CNG tones and the receiving machines “chirps” overlap. This must be for at least 2 to 4 seconds, so the fax machines can understand how each is sending and receiving the fax. The handshake cannot begin until the call is answered, and the CNG tones last for only about 40 seconds after the number is dialed. Therefore, it's important for the receiving machine to answer the call in as few rings as possible.



When you have an external telephone answering device (TAD) on your fax line, your TAD will determine the number of rings before the call is answered. Pay special attention to the directions in the Assembly and Connections chapter for connecting a TAD to your MFC.

ECM (Error Correction Mode)

ECM is a way for the machine to check the integrity of a fax transmission while it is in progress. ECM transmissions are possible only between machines that both have the ECM feature. If they do, you may send and receive fax messages that are continuously checked for their integrity. Sufficient memory must be available in your machine for this feature to work.

2 Assembly and Connections

Packing List

Make sure you have the following items:

Telephone
Line Cord

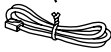

CD-ROM



Drum Unit Assembly
(With free Standard
Toner Cartridge – up
to 3,000 pages)

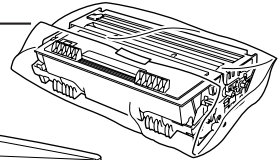

Power Cord

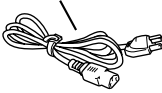

Bi-directional
Parallel Cable

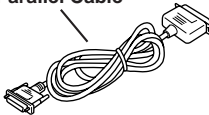

Paper Cassette

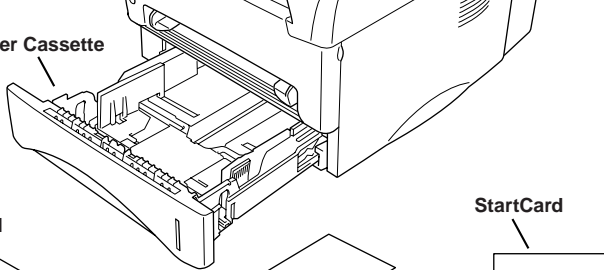

Owner's Manual

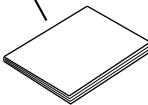

Quick Reference Card

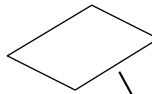

StartCard



If an item is missing, call Brother Customer Service at 1-800-284-4329 (USA), 1-800-853-6660 (**from within Canada**) or 1-514-685-6464 (**from within Montreal**). See *Ordering Accessories and Supplies* on page ii for the correct item numbers.



Whenever you transport the MFC, use the packing materials that came with your MFC. If you do not pack the MFC correctly, you may void your warranty.

Choosing a Location

Place your MFC on a flat stable surface, such as a desk. Select a place that is free of vibration and shocks. Place the MFC near a telephone jack and a standard, grounded power outlet. Choose a location where the temperature remains between 50°F and 95°F (10°–35°C).

- ⊘ Avoid placing your MFC in a high-traffic area. Do not place near heaters, air conditioners, water, chemicals, or refrigerators. Do not expose the MFC to direct sunlight, excessive heat, moisture, or dust. Do not connect your MFC to electrical outlets controlled by wall switches or automatic timers. Disruption of power can wipe out information in the MFC's memory. Do not connect your MFC to electrical outlets on the same circuit as large appliances or other equipment that might disrupt the power supply. Avoid interference sources, such as speakers or the base units of cordless phones.



WARNING

- Use caution when installing or modifying telephone lines. Never touch telephone wires or terminals that are not insulated unless the telephone line has been disconnected at the wall jack. Never install telephone wiring during a lightning storm. Never install a telephone jack in a wet location unless the jack is specifically designed for a wet location.
- Lightning and power surges can damage this product! We recommend that you use a quality surge protection device on the AC power line and on the telephone line, or unplug the lines during a lightning storm.
- For PLUGGABLE EQUIPMENT, the socket-outlet should be installed near the equipment and should be easily accessible.
- To reduce the risk of shock or fire, use only a No. 26 AWG or larger telecommunication line cord.

IMPORTANT SAFETY INSTRUCTIONS

When using your telephone equipment, basic safety precautions should always be followed to reduce the risk of fire, electric shock and injury to persons, including the following:

- 1 Do not use this product near appliances that use water, in a wet basement or near a swimming pool.
- 2 Avoid using a telephone during an electrical storm. There may be a remote risk of electric shock from lightning.

Release the Scanner Lock

Push the blue Scanner Lock Lever up to unlock the scanner. This lever is located on the rear left underside of the scanner cover.

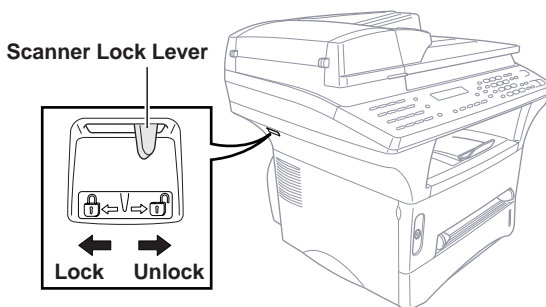

! Caution

If the message “CHECK SCAN LOCK” appears on the display, unlock the scanner immediately and press .

! Caution

If the message “MACHINE ERROR AF” or “MACHINE ERROR AE” appears on the display, do not attempt to operate the machine. Call Customer Service for assistance. Customer Service phone numbers can be found on page i of your Owner’s Manual.

Assembly

Installing the Drum Unit Assembly (with Toner Cartridge)

- 1 Unpack the drum unit assembly, including the toner cartridge, and gently rock it from side to side five or six times to distribute the toner evenly inside the cartridge.

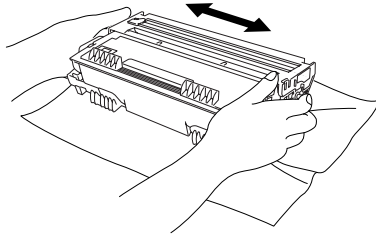

! To prevent damage to the drum, do not expose it to light for longer than a few minutes.

- 2 Open the front cover of the machine.

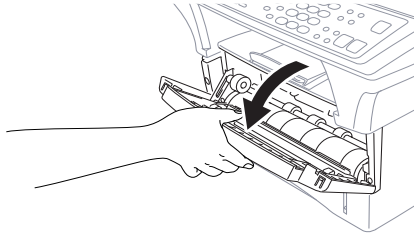

- 3 Insert the drum unit assembly into the machine.

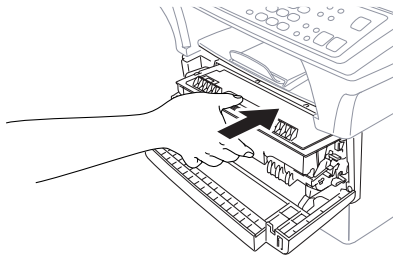

- 4 Close the front cover.

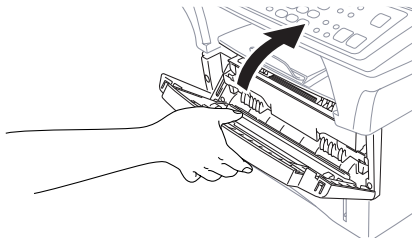

Paper

Acceptable Paper

	Paper Type	Paper Size
Multi-purpose Paper Cassette #1:	cut sheet	Letter, Legal, A4, A5, ISO B5, Executive, A6, 2.75–8.5 x 4.57–14 inches (70–216 x 116–356 mm)
Manual Feed Slot:	cut sheet	Letter, Legal, A4, A5, B5 (JIS/ISO), Executive, A6 2.75–8.5 x 4.57–14 inches (70–216 x 116–356 mm)
	envelopes	COM-10, Monarch, C5, DL
	post cards	2.75–8.5 x 4.57–14 inches (70–216 x 116–356 mm)
	organizer	Day-Timer® J, K, L 2.75–8.5 x 4.57–14 inches (70–216 x 116–356 mm)
	labels and transparencies	2.75–8.5 x 4.57–14 inches (70–216 x 116–356 mm)



We Recommend:

Cut sheet:	Xerox 4200
Labels:	Avery laser label or equivalent
Transparencies:	3M CG3300 for laser printers or equivalent

Paper Capacity of Paper Cassette

Multi-purpose Paper Cassette #1:	Max. paper height is 1.06 inches (27 mm) (use the guides) or approx. 250 sheets of 20 lb. (75 g/m ²) Letter/A4 paper, 10 transparencies.
Front Output Bin:	Approx. 150 sheets of 20 lb. (75 g/m ²) Letter/A4 paper

Paper Specification for the Cassette

Cut Sheet	
Basis Weight:	17 to 28 lb. (64 to 105 g/m ²)
Caliper:	0.003 to 0.005 inches. (0.08 to 0.13 mm)
Moisture Content:	4% to 6% by weight

Manual Feed Slot

	Cut Sheet	Envelopes
Basis Weight:	17 to 42 lb. (64 to 158 g/m ²)	20 to 24 lb. (75 to 90 g/m ²)
Caliper:	0.003 to 0.008 inches. (0.08 to 0.2 mm)	0.003 to 0.005 inches. (0.084 to 0.14 mm)
Moisture Content:	4% to 6% by weight	4% to 6% by weight



Fax messages can be received on Letter, Legal and A4 size paper.

If you use legal or A4, change the Paper Size setting:

([Function], [1], [2], [6].)

Loading Paper in Multi-purpose Paper Cassette

- 1 Pull the paper cassette completely out of the machine.

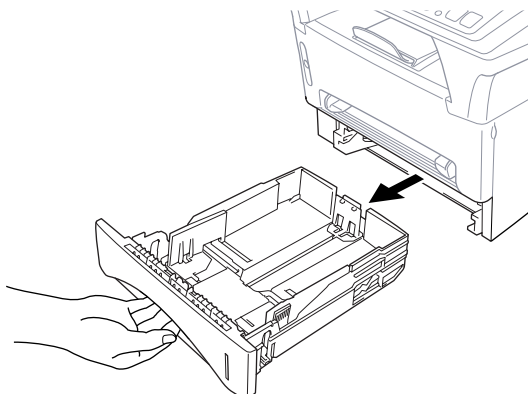

- 2** Slide the paper width and length adjusters to the position for the paper size you are using.

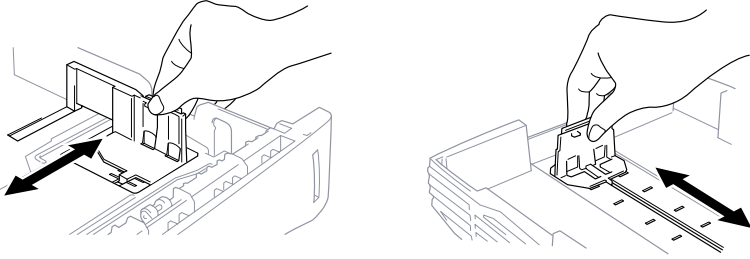

- 3** Fan the paper well. Load paper in the paper cassette. Press down on the paper to flatten it in all four corners, keeping the paper level below the guide. The cassette can hold up to 250 sheets of 20 lb (75g/m²) paper.

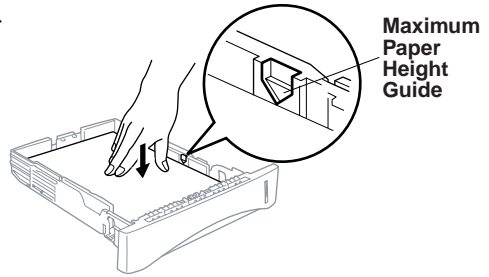

- 4** Slide the paper cassette into the machine until it locks into place.

Manual Feed Slot

Use the manual feed slot to print or copy on envelopes, labels, transparencies, card stock or thicker paper:

The manual feed slot is above the multi-purpose paper cassette. Load paper or envelopes *one at a time*. You do not have to remove paper from the paper cassette.

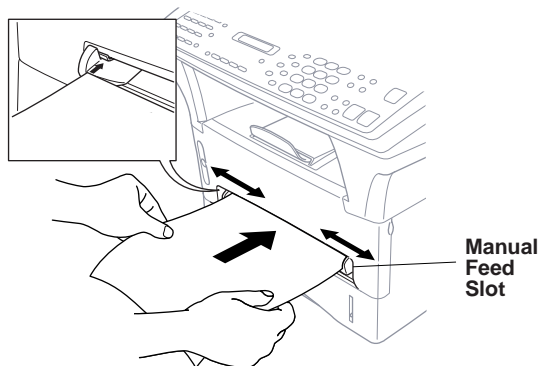

Connecting the MFC

- 1 Connect the power cord.
- 2 Connect the telephone line cord.

Connect one end of the telephone line cord to the line jack on the MFC and the other end to a modular wall jack.

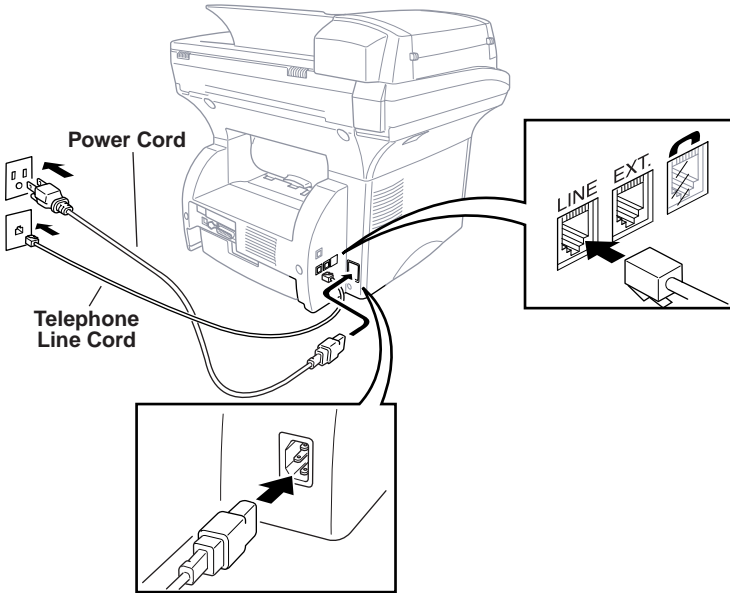

⚠ WARNING

- The MFC must be grounded using a 3-prong plug.
- Since the MFC is grounded through the power outlet, protect yourself from potentially hazardous electrical conditions on the telephone line by keeping the power to your MFC on when you connect it to a telephone line. When you want to move your MFC, protect yourself by disconnecting the telephone line first, and then the power cord.
- Lightning and power surges can damage this product! We recommend that you use a quality surge protection device on the AC power line as well as on the telephone line, or unplug the lines during a lightning storm.
- Do not touch the rollers at the paper exit.

Connections

Connecting an External Telephone

Although your MFC does not have a handset, you can connect a separate telephone (or telephone answering device) directly to your MFC.

Connect the modular plug on the telephone's line cord to the jack labeled EXT. on the left side of the MFC.

Whenever this phone (or TAD) is in use, the screen displays TELEPHONE. To disconnect the call on the external phone and switch to the MFC, press **[Hook]**.

Connecting an External TAD (Telephone Answering Device)

Sequence

You might choose to connect an answering system. When you have an **external** TAD on the same telephone line as the MFC, the TAD answers all calls. The machine "listens" for fax calling (CNG) tones. If it hears them, the MFC takes over the call and receives the fax. If it doesn't hear CNG tones, the MFC lets the TAD continue playing your outgoing message so your caller can leave you a voice message.

The TAD must answer within four rings (the recommended setting is two rings). The MFC cannot hear CNG tones until the TAD has answered the call, and with four rings there are only 8–10 seconds of CNG tones left for the fax "handshake." Make sure you carefully follow the instructions in this manual for recording your outgoing message. We do not recommend using the toll saver feature on your external answering machine if it exceeds 4 rings.

Connections

The external TAD must be plugged into the left side of the MFC in the jack labeled EXT. Your MFC cannot work properly if you plug the TAD into a wall jack.



If You Subscribe to your Telephone Company's Distinctive Ring Service:

You may connect an external TAD to a separate wall jack *only* if you subscribe to your telephone company's Distinctive Ring service, have registered the distinctive ring pattern on your machine, use that number as a fax number and set your MFC's Answer mode to MANUAL.



If You Do NOT Subscribe to Distinctive Ring Service:

You must plug your TAD into the EXT. jack of your MFC. If your TAD is plugged into a wall jack, both your MFC and the TAD will try to control the phone line. (See illustration on page 2-10.)

- ⊘ Do not connect a TAD elsewhere on the same phone line.

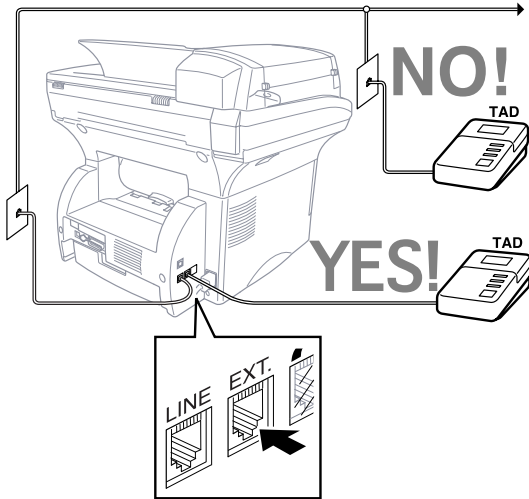

- 1 Plug the telephone line cord from the wall jack into the left side of the MFC, in the jack labeled LINE.
- 2 Plug the telephone line cord from your TAD into the left side of the MFC, in the jack labeled EXT. (Make sure this cord is connected to the TAD at the TAD's telephone line jack, and not its telephone set jack.)
- 3 Set your external TAD to four rings or less. (The MFC's Ring Delay setting does not apply.)
- 4 Record the outgoing message. (See below.)
- 5 Set the Answer mode to EXT. TEL/TAD (Function , , , page 5-1).

Recording Outgoing Message (OGM)

Timing is important in recording this message. The message sets up the ways to handle both manual and automatic fax reception.

- 1 Record 5 seconds of silence at the beginning of your message. (This allows your MFC time to listen for the fax CNG tones of automatic transmissions before they stop.)
- 2 Limit your speaking to 20 seconds. (See *Easy Receive*, page 5-2.)
- 3 End your 20-second message by giving your Fax Receive Code for people sending manual faxes. For example: “**After the beep, leave a message or send a fax by pressing * 5 1 and Start.**”



We recommend beginning your OGM with an initial 5-second silence because the MFC cannot hear fax tones over a resonant or loud voice. You may try omitting this pause, but if your MFC has trouble receiving, then you must rerecord the OGM to include it.

Special Line Considerations

Roll Over Phone Lines

A roll over phone system is a group of two or more separate telephone lines that pass incoming calls to each other if they are busy. The calls are usually passed down or “rolled over” to the next available phone line in a preset order.

Your MFC can work in a roll over system as long as it is the last number in the sequence, so the call cannot roll away. Do not put the MFC on any of the other numbers; when the other lines are busy and a second fax call is received, the fax call would be transferred to a line that does not have a fax machine. **Your MFC will work best on a dedicated line.**

Two-Line Phone System

A two-line phone system is nothing more than two separate phone numbers on the same wall outlet. The two phone numbers can be on separate jacks (RJ11) or combined into one jack (RJ14). Your MFC must be plugged into an RJ11 jack. RJ11 and RJ14 jacks may be equal in size and appearance and both may contain four wires (black, red, green, yellow). To test the type of jack, plug in a two-line phone and see if it can access both lines. If it can, you must separate the line for your MFC.

Converting Telephone Wall Outlets

There are three ways to convert to an RJ11 receptacle. The first two ways may require assistance from the telephone company. You can change the wall outlets from one RJ14 jack to two RJ11 jacks. Or, you can have an RJ11 wall outlet installed and slave or jump one of the phone numbers to it.

The third way is the easiest: Buy a triplex adapter. You can plug a triplex adapter into an RJ14 outlet. It separates the wires into two separate RJ11 jacks (Line 1, Line 2) and a third RJ14 jack (Lines 1 and 2). If your MFC is on Line 1, plug the MFC into L1 of the triplex adapter. If your MFC is on Line 2, plug it into L2 of the triplex adapter.

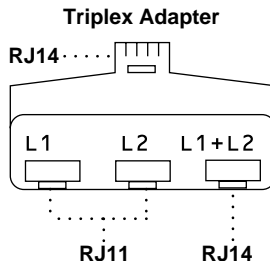

Installing MFC, External Two-Line TAD, and Two-Line Telephone

When you are installing an **external** two-line telephone answering device (TAD) and a two-line telephone, your MFC must be isolated on one line at both the wall jack and at the TAD. *The most common connection is to put the MFC on Line 2, which is our assumption in the following steps.* The back of the two-line TAD must have two telephone jacks: one labeled L1 or L1/L2, and the other labeled L2. You will need at least three telephone line cords, the one that came with your MFC and two for your external two-line TAD. You will need a fourth line cord if you add a two-line telephone.

- 1 Place the two-line TAD and the two-line telephone next to your MFC.
- 2 Plug one end of the telephone line cord for your MFC into the L2 jack of the triplex adapter. Plug the other end into the **LINE** jack on the left side of the MFC.
- 3 Plug one end of the first telephone line cord for your TAD into the L1 jack of the triplex adapter. Plug the other end into the L1 or L1/L2 jack of the two-line TAD.
- 4 Plug one end of the second telephone line cord for your TAD into the L2 jack of the two-line TAD. Plug the other end into the **EXT.** jack on the left side of the MFC.

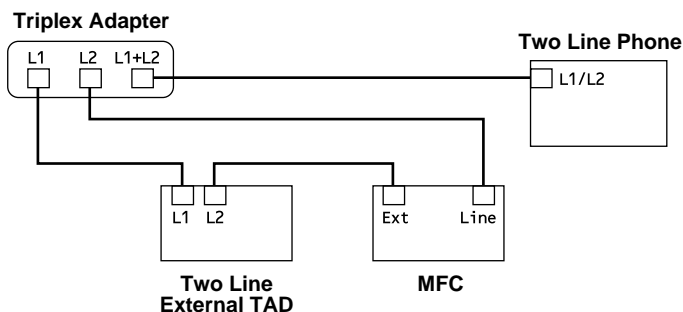

You can keep two-line telephones on other wall outlets as always. There are two ways to add a two-line telephone to the MFC's wall outlet. You can plug the telephone line cord from the two-line telephone into the L1+L2 jack of the triplex adapter. Or, you can plug the two-line telephone into the TEL jack of the two-line TAD.

Multi-Line Connections (PBX)

Most offices use a central telephone system. While it is often relatively simple to connect the MFC to a key system or a PBX (Private Branch Exchange), we suggest that you contact the company that installed your telephone system and ask them to connect the MFC for you. It is advisable to have a separate line for the MFC. You can then leave the MFC in FAX mode to receive faxes any time of day or night.

If the MFC is to be connected to a multi-line system, ask your installer to connect the unit to the last line on the system. This prevents the unit from being activated each time a telephone call is received.

- ⊘ As with all fax units, this MFC must be connected to a two wire system. If your line has more than two wires, proper connection of the MFC cannot be made.

If you are installing the MFC to work with a PBX:

- 1 It is not guaranteed that the unit will operate correctly under all circumstances with a PBX. Any cases of difficulty should be reported first to the company that handles your PBX.
- 2 If all incoming calls will be answered by a switchboard operator, it is recommended that the Answer mode be set to MANUAL. All incoming calls should initially be regarded as telephone calls.
- 3 The MFC may be used with either pulse or tone dialing telephone service.

Custom Features on a Single Line

To learn how custom features may affect your faxing operations, please see the *Troubleshooting and Routine Maintenance* chapter, page 22-1.

3

On-Screen Programming

User-Friendly Programming

We have designed your Multi-Function Center with on-screen programming and a Help key. User-friendly programming helps you take full advantage of all the functions your MFC has to offer.

Since your programming is done on the LCD, we created step-by-step on-screen prompts to help you program your MFC. All you need to do is follow the prompts as they guide you through the function menu selections and programming options and settings.

Function Mode

You can access the Function Mode by pressing **[Function]**. The screen displays

```
1.FAX      2.PRINTER
3.VIDEO
```

Then press **[1]** for Fax Functions—**OR**—press **[2]** for Printer Functions—**OR**—press **[3]** for Video Functions.

When you enter Function Mode, your MFC scrolls a list of main menu options from which you can choose. These menu options appear one after the other on the display. Select a menu by pressing **[Set]** when the option appears on the LCD. The LCD will scroll the options within that menu.

You can scroll more quickly through options by pressing **[→]**. Use **[←]** to scroll backward if you passed your choice or to see options in the opposite order. When the screen displays your selection, press **[Set]**.



When you finish a function, the screen displays ACCEPTED.

If you want to exit the Function Mode, press **[Stop]**.

Function Selection Table

You can probably perform most of these programming settings without the Owner's Manuals. To help you understand the function selections, options and settings that are found in the MFC programs, use the Function Selection Table below.

1. Fax Functions

1. INITIAL SETUP			
Function	Description	Factory Set	Page
1. TONE/PULSE	Selects dialing mode.	TONE	4-1
2. DATE/TIME	Enter date and time for LCD display and heading on transmissions.	—	4-1
3. STATION ID	Program name, fax number and telephone number to appear on each transmitted page.	—	4-2
4. BEEPER	Adjust volume level of beeper.	LOW	4-3
5. SLEEP MODE	Conserve power	00 MIN	4-4
6. DELAYED TIMER	Sets the time of day for delayed faxes. You can accept it or enter another time when you scan each fax into memory in "Delayed Fax"	00:00	4-5
7. SPEAKER VOLUME	Adjust speaker volume.	LOW	4-4
8. RING VOLUME	Adjust volume of ringer.	LOW	4-4
9. AUTO DAYLIGHT	Changes for Daylight Savings Time automatically.	OFF	4-5

1. Fax Functions (continued)

2. SETUP RECEIVE			
Function	Description	Factory Set	Page
1. ANSWER MODE	Choose the mode that best suits your needs: FAX, EXT. TEL/TAD, MANUAL.	FAX	5-1
2. RING DELAY	Number of rings before MFC answers.	RING DELAY: 04	5-2
3. EASY RECEIVE	Receive fax messages without pressing the Start key.	ON	5-2
4. REMOTE CODE	Enter code to activate the MFC from a remote location.	ON (*51)	5-5
5. REDUCTION	Reduces size of image.	AUTO	5-3
6. PAPER	Selects size of paper for receiving faxes.	LETTER	5-3
7. PRINT DENSITY	Prints faxes darker or lighter.	—	5-4
8. POLLING RX	Sets up your MFC to poll another fax machine.	OFF	5-6
9. TONER SAVE	Increases life of toner cartridge.	OFF	5-4
0. MF LINK	Turn on if PC is connected to MFC for PC receiving of fax messages.	ON	12-15

1. Fax Functions (continued)

3. SETUP SEND			
Function	Description	Factory Set	Page
1. COVERPG SETUP	Automatically sends a cover page you program.	OFF	6-7-6-9
2. COVERPAGE MSG	Program customized message for fax cover page.	—	6-8
3. CONTRAST	Change lightness or darkness of a fax you are sending.	AUTO	6-4
4. RESOLUTION	Allows you to change resolutions page by page.	STANDARD	6-11
5. OVERSEAS MODE	Adjusts for sometimes difficult overseas transmissions.	OFF	6-10
6. DELAYED FAX	Send documents later.	—	6-10
7. POLLED TX	Sets up your MFC with a document to be retrieved by another fax machine.	OFF	6-12
8. REAL TIME TX	When memory is full, you can send faxes in real time.	OFF	6-6
9. BATCH TX	Sends all delayed faxes that are to the same fax number and at the same time as one transmission.	OFF	6-11

4. REMAINING JOBS			
Function	Description	Factory Set	Page
	Check which jobs are in memory or cancel a delayed fax or polling job.		5-7, 6-6-6-7

5. SET AUTO DIAL			
Function	Description	Factory Set	Page
1. ONE-TOUCH DIAL	Dial numbers stored in memory by pressing only one key.	—	7-1
2. SPEED-DIAL	Dial numbers stored in memory by pressing only three keys.	—	7-2
3. SETUP GROUPS	Set up a Group number for broadcasting.	—	7-3

1. Fax Functions (continued)

6. PRINT REPORTS			
Function	Description	Factory Set	Page
1. XMIT REPORT	Print lists and reports of activity. (Details in Chapter 9)	OFF	9-2
2. ACT. REPORT		INTERVAL: OFF	9-2
3. ALL DIAL		—	9-1
4. TEL. INDEX		—	9-1
5. USER SETTINGS		—	9-1
6. MEMORY STATUS		—	9-1
7. REMOTE FAX OPT			
Function	Description	Factory Set	Page
1. FAX FWD/PAGING	Set MFC to forward a fax –OR– to call your pager.	OFF	8-1
2. FAX STORAGE	Store incoming fax in memory for remote retrieval.	OFF	8-2
3. REMOTE ACCESS	Set code for retrieving faxes.	159*	8-3
4. PRINT FAX	Print incoming faxes stored in the memory.	—	5-5
0. MISCELLANEOUS			
Function	Description	Factory Set	Page
1. DISTINCTIVE	Use with phone company's Distinctive Ring service to register the ring pattern with the MFC.	OFF	5-8
2. CALLER ID	View or print a list of the last 30 Caller IDs stored in memory.	—	5-9
3. DRUM LIFE	You can check the percentage of drum life that remains available.	—	22-24
4. CASSETTE #2	Turn CASSETTE #2 ON if you purchased the optional Cassette #2.	OFF	5-2

2. Printer Functions

1. PRINT OPTIONS			
Function	Description	Factory Set	Page
1. INTERNAL FONT	You can print resident fonts to check and confirm font types.	—	14-8
2. CONFIGURATION	Printer settings and status are listed here.	—	14-8

2. RESET PRINTER			
Function	Description	Factory Set	Page
1. FACTORY SET	You can restore the printer back to the factory default settings.	—	14-8
2. HEX DUMP MODE	If you set HEX DUMP MODE, all the PC data is printed in hexadecimal.	—	14-8

3. Video Functions

Function	Description	Factory Set	Page
1. QUALITY	Select Normal or High print.	HIGH	11-3
2. VIDEO TYPE	Select Moving or Still video signal.	MOVING	11-4
3. PRINT SIZE	Select the size you want the captured frame to print.	5.75"x4.25"	11-4

<4. LAN MENU FUNCTIONS>

This option appears only if the Network (LAN) Board accessory has been installed. For details see the manual that is included with the accessory.

4 Initial Setup

Getting Started

Setting Dialing Mode (Tone/Pulse)

Your MFC comes set to accommodate tone (multi-frequency) dialing service. If you have pulse (rotary) dialing service, you need to change the dialing mode.

- 1 Press **Function**, **1**, **1**, **1**.
- 2 Use **←** or **→** to select **TONE** or **PULSE** dialing mode and press **Set**.
- 3 Press **Stop** to exit.

```
DIALING:TONE?  
SELECT ← → & SET
```

```
DIALING:PULSE?  
SELECT ← → & SET
```

Setting Date and Time

Your MFC displays the date and time, and prints it on every fax you send.

In the event of a power failure, you may have to reset the date and time. All other settings remain unaffected.

- 1 Press **Function**, **1**, **1**, **2**.
- 2 Enter the last two digits of the year and press **Set**.
For example, enter 00 for the year 2000.
- 3 Enter two digits for the month and press **Set**.
For example, enter 09 for September, or 10 for October.
- 4 Enter two digits for the day and press **Set**.
For example, 06
- 5 Enter the time in 24-hour format and press **Set**.
For example, enter 15:25 for 3:25 PM.
- 6 Press **Stop**.
The screen now displays the date and time you set, and displays it whenever the MFC is standing by.

```
YEAR:XX  
ENTER & SET
```

```
MONTH:XX  
ENTER & SET
```

```
DAY:XX  
ENTER & SET
```

```
TIME:XX:XX  
ENTER & SET
```

Setting Station ID

You can store your name, fax number, and telephone number to be printed on all fax pages you send. (See *Composing Electronic Cover Page*, page 6-7.)

- 1 Press **Function**, **1**, **1**, **3**.
- 2 Enter your fax number (up to 20 digits) and press **Set**.
(You must enter a fax number to proceed.)

FAX:
ENTER & SET

- 3 Enter your telephone number (up to 20 digits) and press **Set**. If your telephone number and fax number are the same, enter the same number again.
(This number appears on Cover pages.)

TEL:
ENTER & SET

- 4 Press **Set**.
- 5 Use the dial pad to enter your name or your company name (up to 20 characters) and press **Set**.
(See *Entering Text*, below.)

NAME:
ENTER & SET

- 6 Press **Stop**.

The screen returns to the date and time.



If your Station ID has already been programmed, the screen prompts “1” to make a change, or “2” to exit without changing.

Entering Text

When you are setting certain functions, such as the Station ID, you may need to enter text into the MFC. Most number keys have three or four letters printed above them. The keys for 0, #, and * don't have printed letters because they are used for special characters.



By pressing the appropriate number key the correct number of times, you can access the character you want.

Key	once	twice	three times	four times
2	A	B	C	
3	D	E	F	
4	G	H	I	
5	J	K	L	
6	M	N	O	
7	P	Q	R	S
8	T	U	V	
9	W	X	Y	Z

Inserting spaces

If you want to enter a blank space, press  twice.

Making corrections

If you entered a letter incorrectly and want to change it, press  to move the cursor after the last correct letter. Then press ; all letters above and to the right of the cursor are deleted. Re-enter the correct text and/or digits. You can also back up and type over incorrect letters.

Repeating letters

If you need to enter a character assigned to the same key as the previous character, press  to move the cursor to the right.

Special characters and symbols

Press  for (space) ! " # \$ % & ' () * + , - . /

Press # for : ; < = > ? @ [] ^ _

Press  for É À È Ê Î Ç Ë Ö 0









NOTICE

The Telephone Consumer Protection Act of 1991 makes it unlawful for any person to use a computer or electronic device to send any message via a telephone MFC unless such messages clearly contain, in a margin at the top or bottom of each transmitted page, or on the first page of the transmission, the date and time it is sent and an identification of the business or other entity or other individual sending the message and the telephone number of the sending machines or such business, other entity, or individual.

In order to program this information into your MFC, you should complete the steps described on pages 4-1 and 4-2.

Setting Beeper Volume

You can set the beeper to LOW, HIGH or OFF. The default setting is **LOW**. When the beeper is set to LOW or HIGH, the MFC beeps every time you press a key or make an error, and at the end of fax sending or receiving.

- 1 Press , , , .
- 2 Press  or  to select your setting and press .
- 3 Press  to exit.

Speaker Volume

You can set the volume of the MFC speaker.

- 1 Press **Function**, **1**, **1**, **7**.
- 2 Press **←** or **→** to select your volume setting (OFF, LOW, MED, or HIGH) and press **Set**.
- 3 Press **Stop** to exit.

In the OFF setting the speaker defaults to LOW when you press **Hook**.

Ring Volume

You can set the volume of the ring or turn it off.

- 1 Press **Function**, **1**, **1**, **8**.
- 2 Press **←** or **→** to select OFF, LOW, MED, or HIGH and press **Set**.
- 3 Press **Stop** to exit.

Memory Storage

In the event of a power failure, all settings in the functions are stored permanently: INITIAL SETUP, SETUP RECEIVE, SET AUTO DIAL, REMOTE FAX OPT plus the COVERPG SETUP and COVERPAGE MSG (from SETUP SEND). You may have to reset the date and time.

Sleep Mode

Setting the Sleep Mode reduces power consumption while the machine is idle. You can choose how long the machine is idle (from 00 to 99 minutes) before it drops into sleep mode. The timer automatically resets when the machine receives a fax or PC data, or makes a copy. The default setting is 0 minutes.

- 1 Press **Function**, **1**, **1**, **5**.
- 2 Use the Dial pad to enter the amount of time the machine is idle before it drops into sleep mode (00 to 99 minutes) and press **Set**.
- 3 Press **Stop** to exit.



If you make copies frequently, make the idle time long enough so you won't always be waiting for the machine to warm up.

Delayed Timer

You can set up the time of day that delayed faxes will be sent. This time will be displayed for acceptance or override when you scan faxes into memory in *Delayed Fax*, page 6-10.

1 Press **[Function]**, **[1]**, **[1]**, **[6]**.

2 Enter the time (in 24-hour format) that you want delayed faxes to be sent and press **[Set]**.

```
SET TIME:12:34
ENTER & SET
```

3 Press **[Stop]** to exit.

```
SET TIME:17:00
ENTER & SET
```

Turning On Automatic Daylight Savings Time

You can set the machine to change automatically for Daylight Savings Time by resetting itself forward one hour in the Spring and backward one hour in the Fall.

1 Press **[Function]**, **[1]**, **[1]**, **[9]**.

```
9.AUTO DAYLIGHT
```

2 Press **[←]** or **[→]** to select **ON** (or **OFF**) and press **[Set]**.

3 Press **[Stop]** to exit.

5 Setup Receive

Basic Receiving Operations

Mode	How it works	When to use it	Page
MANUAL	You control the phone line and must answer every call yourself.	Use this mode when you are using a computer modem on the same line or if you are using the Distinctive Ring subscriber service.	5-8
FAX	The MFC automatically answers every call as a fax.	For dedicated fax line. You cannot receive a voice call but you can call out from an external or extension telephone.	1-4
EXT.TEL/TAD	<p>If an external telephone is connected to the EXT. jack you control the phone line and must answer every call yourself.</p> <p>If an external TAD (telephone answering device) is connected to the EXT. jack, the TAD automatically answers every call. Voice messages are Stored in external TAD. Fax messages are printed.</p>	<p>Use this mode if you receive very few faxes.</p> <p>Use this mode if you have an answering machine on your phone line.</p>	2-10 2-11

Setting or Changing the Answer Mode

- 1 Press **Function**, **1**, **2**, **1**.

1. ANSWER MODE

- 2 Press **←** or **→** to select MANUAL, EXTERNAL TEL/TAD or FAX mode and press **Set**.

FAX?

EXT. TEL/TAD?

MANUAL?

- 3 Press **Stop** to exit.

Setting Ring Delay

The Ring Delay setting determines the number of times the MFC rings before it answers.

- 1 Press **Function**, **1**, **2**, **2**.
- 2 Press **←** or **→** to select how many times the line rings before the MFC answers (00–04) and press **Set**. If you select 00, the line doesn't ring at all.
- 3 Press **Stop** to exit.

Easy Receive

When you use this feature, you don't have to press **Start** when you answer a fax call. Selecting **ON** allows the MFC to receive fax calls automatically, even if you lift the handset of an extension or external phone. When you see RECEIVING on the fax screen or when you hear "chirps" through the handset of an extension phone connected to another wall jack, just replace the handset, and your MFC does the rest. Selecting **OFF** means you'll have to activate the MFC yourself, by pressing **Hook**, then **Start** to receive. (See *Manual Transmission*, page 6-5.)—**OR**—by pressing ***51** if you are not at your MFC. (See *Operation from Extension Telephones*, page 5-5.)

 If Easy Receive is OFF and an original is in the ADF, press **Hook**, then **Start**, then **2** to activate the MFC.

 If you've set the feature to **ON**, but your MFC doesn't automatically connect a fax call when you lift an external or extension phone handset, press the Fax Receive code ***51**.

 If you send faxes from a computer on the same phone line and the MFC intercepts them, set Easy Receive to OFF.

- 1 Press **Function**, **1**, **2**, **3**.
- 2 Use **←** or **→** to select **ON** or **OFF** and press **Set**.
- 3 Press **Stop** to exit.

Turning on Cassette #2

When CASSETTE #2 is set to ON, you can set paper size, reduction setting and the cassette usage. (See *Printing a Reduced Incoming Document*, page 5-3 and *Setting Paper Size*, page 5-3.)

- 1 Press **Function**, **1**, **0**, **4**.
- 2 Press **←** or **→** to select ON (or OFF) and press **Set**.
- 3 Press **Stop** to exit.

Printing a Reduced Incoming Document

You can always reduce the size of an incoming fax to a fixed percentage. If you choose AUTO, your MFC chooses the level of reduction for you.

If you purchased and attached the optional Cassette #2 you can select the reduction ratio for each cassette.

- 1 Press **[Function]**, **[1]**, **[2]**, **[5]**.
- 2 If you have the optional Cassette #2 press **[←]** or **[→]** to select CASSETTE #1 or CASSETTE #2 and press **[Set]**.
- 3 Use **[←]** or **[→]** to select the reduction ratio you want (**AUTO**, **100%**, **93%**, **87%** or **75%**) and press **[Set]**. Choose 100% if you don't want a reduction.

5. REDUCTION
- 4 Press **[Stop]** to exit.

Recommended Reductions

If your paper is letter size (8.5" x 11"), and the incoming fax is

letter size, select 93%

A4, select 87%

legal size, select 75%

If your paper is legal size (8.5" x 14"), and the incoming fax is

letter size, select 100%

A4, select 100%

legal size, select 93%

Setting Paper Size

You can use three sizes of paper for printing your faxes — letter, legal, and A4. When you change the paper in the MFC, you must change the setting for paper size, so your MFC will know how to fit the incoming faxes on the paper. You can also select a reduction ratio.

If you purchased and attached the optional Cassette #2 you can select the paper size for each cassette.

- 1 Press **[Function]**, **[1]**, **[2]**, **[6]**.
- 2 *If you have the optional Cassette #2* press **[←]** or **[→]** to select **CASSETTE #1** or **CASSETTE #2** and press **[Set]**.

CASSETTE #2
SELECT ← → & SET

- 3 Use or to select **LETTER, LEGAL** or **A4** and press .

6.PAPER

- 4 Press if you need to change the reduction setting—**OR**—Press and go to Step 6.

CHANGE REDUCTION
1.YES 2.NO

- 5 Use or to select **AUTO, 100%, 93%, 87%** or **75%** and press .
- 6 Press to exit.

Setting Cassette Usage

The default setting of **AUTO** allows your machine to choose Cassette #2 if paper is out in Cassette #1 or if incoming faxes will fit best on the paper in Cassette #2. Choose **CASSETTE#1 ONLY** or **CASSETTE#2 ONLY** if you want to keep special paper in the other cassette and control when it is used.

- 1 Press , , , .
- 2 Press or to select **CASSETTE USAGE** and press .
- 3 Press or to select **AUTO, CASSETTE#1 ONLY** or **CASSETTE#2 ONLY** and press .
- 4 Press to exit.

Setting the Print Density

You can adjust print density, making your printed documents darker or lighter.

- 1 Press , , , .
- 2 Press to make print lighter, or to make print darker.
- 3 Press to exit.

Toner Save

You can conserve toner using this feature. When you set **Toner Save** to **ON**, print appears somewhat lighter. The default setting is **OFF**.

- 1 Press , , , .
- 2 Press or to turn **ON** (or **OFF**) and press .
- 3 Press to exit.

Advanced Receiving Operations

Operation from Extension Telephones

If you answer a fax call on an extension phone (or on an external phone in the EXT. jack), you can make your MFC take over by using the Fax Receive Code. When you press the Fax Receive Code **[*] [5] [1]**, the MFC starts to receive a fax. (See *Easy Receive*, page 5-2.)

If you answer a call at an extension or external phone, and no one is on the line, assume you're receiving a fax. At an extension phone, press **[*] [5] [1]**, wait for fax receiving tones (chirps), then hang up. At an external phone, press **[*] [5] [1]** and wait for the phone to be disconnected (the screen displays RECEIVING) before you hang up. (Your caller will have to press **[Start]** to send the fax.)

Changing the Fax Receive Code

The preset Fax Receive Code (**[*] [5] [1]**) may not work with some telephone systems.

If you are always disconnected when accessing your external TAD remotely, try changing the Fax Receive Code from **[*] [5] [1]** to **[#] [#] [#]**.

- 1 Press **[Function]**, **[1]**, **[2]**, **[4]**.
- 2 Press **[←]** or **[→]** to select ON (or OFF) and press **[Set]**.
- 3 If you want to, enter a new Fax Receive Code and press **[Set]**.
- 4 Press **[Stop]** to exit.

```
REMOTE ACT.:ON?  
SELECT ← → & SET
```

```
FAX RECEIVE:*51  
ENTER & SET
```

Printing a Fax in Memory

If you have Fax Storage ON for remote retrieval, you can still print a fax from memory when you are at your MFC. (See *Setting Fax Storage*, page 8-2.)

- 1 Press **[Function]**, **[1]**, **[7]**, **[4]**.
- 2 Press **[Start]**.
- 3 After printing is finished, press **[Stop]** to exit.

Polling

Polling is the process of retrieving faxes from another fax machine. You can use your MFC to “poll” other machines, or you can have someone poll your MFC.

All parties involved in polling must set up their fax machines to accommodate polling. When someone polls your MFC to receive a fax, they pay for the call; if you poll someone’s fax machine to receive a fax, you pay for the call.



Some fax machines do not respond to the polling function.

Setting Up Polling Receive

Polling Receive is when you call another fax machine to receive a fax from it.

- 1 Press **Function**, **1**, **2**, **8**.
- 2 Press **←** or **→** to choose **ON** and press **Set**.
- 3 Enter the fax number you’re polling.
- 4 Press **Start**.
The screen displays DIALING.

```
POLLING RX:OFF?  
SELECT ← → & SET
```

```
ENTER FAX NO.  
PRESS START KEY
```

Setting Up Sequential Polling Receive

Your MFC can request documents from several fax units in a single operation. Afterward, a Sequential Polling Report will be printed.

- 1 Press **Function**, **1**, **2**, **8**.
- 2 Press **←** or **→** to select Polling **ON** and press **Set**.
- 3 Specify the destination fax machines you wish to poll, using One Touch, Speed Dial, Groups or the dial pad. You must press **Broadcast** between each location.
- 4 Press **Start**.

```
POLLING RX:ON?  
SELECT ← → & SET
```

```
ENTER FAX NO.  
PRESS START KEY
```

```
ACCEPTED  
ONLINE
```

Your MFC will poll each number or group member in turn for a document.

```
DIALING  
ONLINE
```

Canceling a Scheduled Job

You can cancel tasks you've scheduled, such as Delayed Fax or Polling Transmit. (See *Checking Job Status*, page 6-6.)

- 1 Press **Function**, **1**, **4**.

Jobs waiting to be sent from memory appear on the display. If there are no jobs, the screen displays NO JOB WAITING.



- 2 If you have more than two jobs waiting, press **←** or **→** to select the job you want to cancel and press **Set**.
- 3 Press **1** to cancel—**OR**—Press **2** to exit without canceling. To cancel another job, return to Step 2.
- 4 Press **Stop** to exit.

Telephone Services

Distinctive Ring

This feature lets you use the Distinctive Ring subscriber service offered by some telephone companies, which allows you to have several telephone numbers on one phone line. Each phone number has its own Distinctive Ring pattern, so you'll know which phone number is ringing. This is one way you can have a separate phone number for your MFC.

Your MFC has a Distinctive Ring function, allowing you to dedicate one phone number just for receiving faxes. You'll need to follow the directions below to "register" the new Distinctive Ring pattern, that was assigned by the Telephone Company, so your MFC can recognize its incoming calls.



You can change or cancel the Distinctive Ring pattern at any time. You can switch it off temporarily, then turn it back on. When you get a new fax number, be sure you reset this function.





You can register only one Distinctive Ring pattern with the MFC. Some ring patterns cannot be registered.

- The MFC will answer only calls to its registered number.
- You will not hear the first two rings of all incoming calls on the MFC.
- To have your external TAD answer only the main number, the MFC must be in MANUAL Mode.
- In FAX mode, the MFC will answer all numbers on the phone line.

Registering your Distinctive Ring Pattern

If you are not sure which ring pattern you have, call your telephone company. Then assign that pattern in the steps below.

- 1 Set the machine to **MANUAL** mode.
- 2 Press **Function**, **1**, **0**, **1**.
The screen displays the current setting of this feature.
- 3 Press **←** or **→** to select the SET Mode.
- 4 Press **Set** when the screen displays DISTINCTIVE:SET?
- 5 Press **←** or **→** to select the prestored ring pattern you want to assign and press **Set**. (You will hear each pattern as you scroll through the four patterns. Be sure to choose the pattern assigned by the Telephone Company.)

Ring Pattern	Rings	
1	long - long	
2	short - long - short	
3	short - short - long	
4	very long (normal pattern)	

- 6 Press **Stop** to exit.

Once you've registered the Distinctive Ring pattern in your machine, you can turn this feature on or off. To change the setting, follow Steps 1 to 5 above, selecting ON (or OFF).

Caller ID

The Caller ID feature lets you use the Caller ID subscriber service offered by many local phone companies. Subscriber services send the name or telephone number of your caller as the line rings.

When a call comes in, after a few rings, the MFC displays the telephone number of your caller (or name, if available). Once the call is answered, the Caller ID information disappears from the screen, but the call information remains stored in the Caller ID memory.

- You will see the first 16 characters of the number or name.
- OUT OF AREA display means call originates outside your Caller ID service area.
- PRIVATE CALL display means the caller has intentionally blocked transmission of information.



If both the name and number are received, the screen displays only the name. You can print a list of received Caller ID information.

Caller ID service varies with different carriers. Call your local phone company to determine the kind of service available in your area.

Viewing Caller ID List

Caller ID memory stores information for up to thirty calls; when the thirty-first call comes in, the first call is erased. You can scroll through Caller ID information to review those calls made to your MFC.

- 1 Press **[Function]**, **[1]**, **[0]**, **[2]**.
- 2 Press **[←]** or **[→]** to select DISPLAY #? and press **[Set]**.
If the name was not received, it will not be displayed.
- 3 Press **[←]** or **[→]** to scroll through the Caller ID memory to select the Caller ID you want to view and press **[Set]**.
The next screen shows the caller's telephone number, date and time of the call.
- 4 Press **[←]** or **[→]** to return to the Caller ID listing—**OR**—Press **[Stop]** to exit.

Printing Caller ID List

- 1 Press **[Function]**, **[1]**, **[0]**, **[2]**.
- 2 Press **[←]** or **[→]** to select PRINT REPORT? and press **[Set]**.
- 3 Press **[Start]**.

Clearing a Caller ID Stored in Memory

For effective use of the memory, we recommend that you clear the Caller ID information from memory, by pressing  when the display shows the number or name.

6 Setup Send

Before You Begin

You can send a fax from the ADF (Automatic Document Feeder) or from the scanner glass.

Sending Faxes Using Multiple Settings

When you send a fax you can choose any combination of the available settings: add a cover page and select a comment; set the contrast or resolution; send using overseas mode, or delayed fax timer, polling transmission or real time transmission. After each function is accepted, the display will ask if you want to enter other settings:

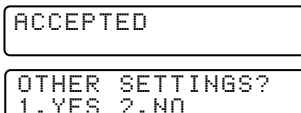

Press **1** if you want to select additional settings. The display returns to the SETUP SEND menu—**OR**—Press **2** if you are finished choosing settings, and go to the next step.

Faxing from the ADF (Automatic Document Feeder)

The ADF can hold up to 50 pages, feeding each one individually through the MFC. Use standard (20 lb/75g/m²) paper when using the ADF. Always fan the pages well before placing them in the feeder.

Temperature: 68°F – 86°F (20°C – 30°C)

Humidity: 50% – 70%

Paper: Xerox 4200 (20LB/LTR),
Xerox 4024 (24LB/LTR),

- ⊘ **DO NOT** use curled, wrinkled, folded, ripped paper, or paper with staples, paper clips, paste or tape attached. **DO NOT** use cardboard, newspaper, or fabric. (To fax this kind of document, see *Faxing from the Scanner Glass*, page 6-3.)
- Make sure documents written with ink are completely dry.

- Originals to be faxed must be from 5.8 to 8.5 inches wide, and 5 to 14 inches long.

- ① Insert originals *face up, top edge first*.
- ② Adjust the paper guides to fit the width of your original.
- ③ Stagger the pages. Then place them in the ADF, until you feel the first page lightly touch the feed roller.

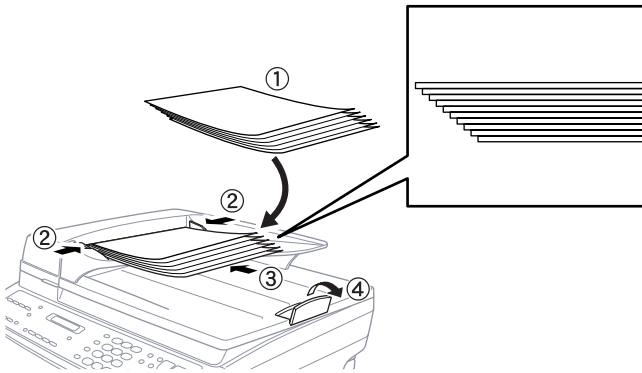
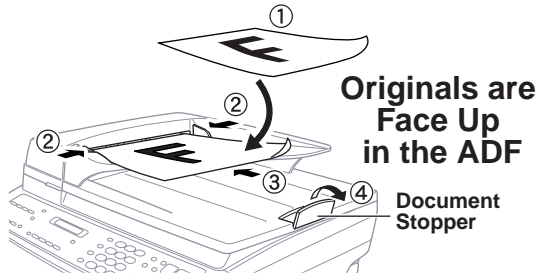

- ④ Pull up the document stopper.

Faxing from the Scanner Glass

You can use the scanner glass to fax one page at a time or pages of a book. Originals can be letter or A4 size (8.5 inches to 11.7 inches).

! To use the scanner glass, the ADF must be empty.

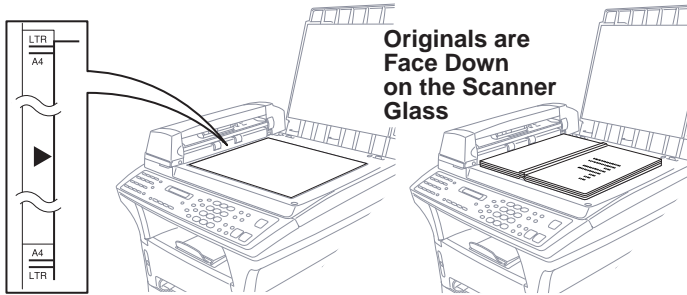

- 1 Lift the document cover.
- 2 Using the document guidelines on the left, center the original *face down* on the scanner glass.
- 3 Close the document cover.

! If the original is a book or is thick, do not slam the cover or press on it.

- 4 Dial the fax number, then press **Start**.
The MFC starts scanning the first page.
- 5 To send a single page, go to Step 7—**OR**—
To send multiple pages, go to Step 6.

MEMORY #01 100%

SET: NEXT PAGE
START: TO DIAL

- 6 Place the next page on the scanner glass and press **Set**. The MFC starts scanning. (Repeat Step 6 for each additional page.)
- 7 Press **Start** to begin dialing.

🔍 Press **Stop** to cancel. If the original was scanned into memory, press **1** to CLEAR it—**OR**—**2** to EXIT.

🔍 If memory is full, and you are faxing a single page, it will be sent in real time.

🔍 You cannot fax from the scanner glass when the MFC is sending, receiving or printing a fax.

Resolution

- Press **Resolution** before you send the fax to select the resolution for the original you are sending. (See *Multiple Resolution Transmission*, page 6-11.)

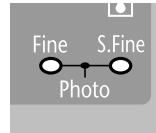

Standard—Suitable for most typed originals. (Fine and S. Fine lights are off.)

Fine—Good for small print; transmits slower than standard resolution. (Only the Fine light is on.)

Super Fine—Good for small print or artwork; transmits slower than fine resolution. (Only the S. Fine light is on.)

Photo—Good for originals with varying shades of gray; slowest transmission time. (Both Fine and S. Fine lights are on.)

Contrast

If your document is very light or very dark, you can set the contrast accordingly. Use S.LIGHT to send a very light originals. Use S.DARK to send a very dark original.

- 1 Insert the original in the ADF or on the scanner glass.
- 2 Press **Function**, **1**, **3**, **3**.
- 3 Use **←** or **→** to select AUTO, S.LIGHT or S.DARK and press **Set**.
- 4 Press **1** if you want to select additional settings. The display returns to the SETUP SEND menu—**OR**—Press **2** if you are finished choosing settings, and go to Step 5.
- 5 Enter a fax number and press **Start** to send a fax.

Automatic Transmission

This is the easiest way to send a fax. **IMPORTANT:** Do **not** press **Hook**.

- 1 Insert the original in the ADF or on the scanner glass.
- 2 Enter the fax number using One Touch, Speed Dial, Tel-index or the dial pad. (See *Speed Dialing*, page 7-4.)
- 3 Press **Start**.

Manual Transmission

Manual transmission lets you hear the dial tone, ringing and fax receiving tones before sending the fax.

- 1 Insert the original in the ADF or on the scanner glass.
- 2 Press **[Hook]** for a dial tone.
- 3 Enter the fax number you want to call (you can enter the digits using the dial pad, or you can enter a One Touch or Speed Dial number or you can call from the Tel-index). (See *Auto Dial Numbers and Dialing Options*, page 7-1.)
- 4 When you hear the fax tone, press **[Start]**—**OR**—If you are using the scanner glass, go to step 5.
- 5 Press **[1]** to begin sending.

1. SEND 2. RECEIVE

Manual and Automatic Fax Redial

If you're sending a fax manually and the line is busy, press **[Redial/Pause]** to retry the number.

If you're sending a fax automatically and the line is busy, the MFC will automatically redial up to three times at 5 minute intervals.

Dual Access

If the ADF is empty, you can place an original in the ADF and set temporary settings, dial a number, and begin scanning the fax into memory—even when the MFC is receiving a fax, sending a fax, or printing a fax from memory. The screen displays the new job number and available memory.



You cannot use fax from the scanner glass when the MFC is sending, receiving or printing a fax.



If you get a MEMORY FULL message while scanning the first page of a fax press **[Stop]** to cancel the scan. If you get a MEMORY FULL message while scanning in a subsequent page, you'll have the option to press **[Start]** to transmit the pages scanned so far, or to press **[Stop]** to cancel the operation.



The number of pages you can scan into memory varies with the data they contain.

Real Time Transmission

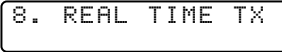
When you have a MEMORY FULL message, the MFC cannot continue scanning pages into memory before sending. However, you can turn on REALTIME TX.

- 1 Insert the original in the feeder or on the scanner glass.
- 2 Press **[Function]**, **[1]**, **[3]**, **[8]**.

- 3 To change the default setting, press **[←]** or **[→]** to select ON (or OFF) and press **[Set]**. Go to Step 5—**OR**—For the next fax transmission only, press **[←]** or **[→]** to select NEXT FAX ONLY and press **[Set]**.

- 4 For the next fax only, press **[←]** or **[→]** to select ON (or OFF) and press **[Set]**.
- 5 Press **[1]** if you want to select additional settings. The display returns to the SETUP SEND menu—**OR**—Press **[2]** if you are finished choosing settings and go to Step 6.
- 6 Enter fax number and press **[Start]**.

Checking the Jobs Status

Check memory for unsent jobs. (If no memory is clear, the screen displays NO JOB WAITING.) (See *Canceling Jobs in Memory*, page 6-7.)

- 1 If the machine is idle, press **[Function]**, **[1]**, **[4]**.
—**OR**—
If the MFC is busy, press **[Stop]**.
- 2 If you have multiple jobs waiting, use **[←]** or **[→]** to scroll through the list.
- 3 Press **[Stop]** to exit.

Canceling Jobs in Memory

You can cancel tasks you've scheduled, such as Polling Transmit, as well as all faxes waiting in Memory. If jobs are waiting, they appear on the display; otherwise, the screen displays NO JOB WAITING.

- 1 Press **[Function]**, **[1]**, **[4]**.

4. REMAINING JOBS

- 2 If you have more than two jobs waiting, use **[←]** or **[→]** to select the job you want to cancel and press **[Set]**.

—OR—

If you have only one job waiting, press **[Stop]**.

- 3 Press **[1]** to cancel—OR—Press **[2]** to exit without canceling.

- 4 Press **[Stop]** to exit.



If the fax machine is busy, press **[Stop]**, then follow Steps 2 through 4 to cancel a job.

Basic Sending Operations

Composing Electronic Cover Page

The cover page is generated at the receiving party's machine. Your cover page includes the name stored in the One Touch or Speed Dial memory. If you're dialing manually, the name is left blank. (See *One Touch Dialing* and *Speed Dialing*, page 7-4.)

The cover page indicates your Station ID, and the number of pages you're sending. If you have Coverpage Setup set to ON (**[Function]** **[1]** **[3]** **[1]**), the number of pages remains blank. (See *Setting Station ID*, page 4-2.)

You can include a comment on your cover page.

1. COMMENT OFF

2. PLEASE CALL

3. URGENT

4. CONFIDENTIAL

Instead of using one of the pre-programmed comments above, you can enter one of two customized messages. (Up to 27 characters long) Use the chart on page 4-2 to help enter characters. (See *Composing Your Own Comments*, page 6-8.)

5. <USER DEFINED>

6. <USER DEFINED>

Most of the SETUP SEND functions are temporary settings that allow you to make adjustments for each fax you send. However, you can set up your cover page and cover page comments in advance. The Cover Page Setup and Cover Page Message functions change the default settings.

Composing Your Own Comments

You can set up two custom comments.

- 1 Press **Function**, **1**, **3**, **2**.
- 2 Press **←** or **→** to choose position 5 or 6 for your customized comment and press **Set**.
- 3 Use the dial pad to enter your customized comment and press **Set**.
(See *Entering Text*, page 4-2.)
- 4 Press **1** if you want to select additional settings. The display returns to the SETUP SEND menu—**OR**—Press **2** to exit.

Cover Page for Next Fax Only

Make sure the Station ID is set up. (See page 4-2.) This feature does not work without the Station ID.

You can set the fax to send a cover page with a particular fax. This cover page will include the number of pages in your original.

- 1 Insert the original in the ADF or on the scanner glass.
- 2 Press **Function**, **1**, **3**, **1**.
- 3 When the screen displays **NEXT FAX ONLY?**, press **Set**.
- 4 Press **←** or **→** to select **ON** (or **OFF**) and press **Set**.
- 5 Press **←** or **→** to select one of the standard or custom comments and press **Set**.
- 6 Enter two digits to indicate the number of pages you are sending and press **Set**.
(Enter **00** to leave the number of pages blank.) If you make a mistake, press **←** to back up and reenter the number of pages.

- 7 Press **1** if you want to select additional settings. The display returns to the SETUP SEND menu—**OR**—Press **2** if you are finished choosing settings.
- 8 Enter the fax number you're calling.
- 9 Press **Start**.

Always Send Cover Page

Make sure Station ID is set up. This feature does not work without the Station ID. (See *Setting Station ID*, page 4-2.)

You can set the MFC to send a cover page whenever you send a fax. The number of fax pages is not included when you use this setting.

- 1 Press **Function**, **1**, **3**, **1**.
- 2 Press **←** or **→** to select **COVERPAGE: ON?** and press **Set**.

```
COVERPAGE:OFF?
SELECT ← → & SET
```

```
COVERPAGE:ON?
SELECT ← → & SET
```

- 3 If you selected ON, press **←** or **→** to select one of the standard or custom comments and press **Set**.
- 4 Press **1** if you want to select additional settings. The display returns to the SETUP SEND menu—**OR**—Press **2** to exit if you are finished choosing settings.

Using a Printed Cover Page

If you prefer using a printed cover page that you can write on, you can print the sample page and attach it to your fax.

- 1 Press **Function**, **1**, **3**, **1**.
- 2 Press **←** or **→** to select PRINT SAMPLE? and press **Set**.
- 3 Press **Start**. Your machine prints a copy of your cover page.

```

=== COVER PAGE ===

TO:      _____
FROM:    _____
FAX:    _____
TEL:    _____

          PAGE[S] TO FOLLOW

COMMENT:
```

Advanced Sending Operations

Overseas Mode

After you send a fax using this feature, the feature turns itself off.

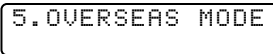
- 1 Insert original in the ADF or on the scanner glass.
- 2 Press **[Function]**, **[1]**, **[3]**, **[5]**.

- 3 Press **[←]** or **[→]** to select ON (or OFF) and press **[Set]**.
- 4 Press **[1]** if you want to select additional settings. The display returns to the SETUP SEND menu—**OR**—Press **[2]** if you are finished choosing settings.
- 5 Enter the fax number you're calling.
- 6 Press **[Start]**.

Delayed Fax

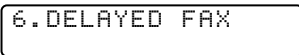
During the day you can store up to 50 faxes in memory for delayed sending. Transmission of these messages will begin at the time of day you enter in Step 3. If you have set up a time of day in the *Delayed Timer* function, page 4-5, you can accept it or enter another time for this fax.

- 1 Insert the original in the ADF, or on the scanner glass.
- 2 Press **[Function]**, **[1]**, **[3]**, **[6]**.

- 3 Accept the displayed time or enter another time for this fax and press **[Set]**. (For example, enter 19:45 for 7:45 PM.)
- 4 Press **[1]** if you want to select additional settings. The display returns to the SETUP SEND menu—**OR**—Press **[2]** if you are finished choosing settings.
- 5 Enter the fax number.
- 6 Press **[Start]**.
The MFC starts scanning the document into memory. It will wait until the time you have entered to send the fax.



The number of pages you can scan into memory varies with the data they contain.

Delayed Batch Transmission

Before sending the delayed faxes, your Brother machine will economize by sorting all the messages in memory by destination and scheduled time. All delayed faxes scheduled at the same time to the same fax number will be sent as one transmission.

- 1 Press **Function**, **1**, **3**, **9**.
- 2 Press **←** or **→** to select ON (or OFF) and press **Set**.
- 3 Press **Stop** to exit.

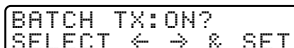

BATCH TX: ON?
SELECT ← → & SET

Multiple Resolution Transmission

Use this feature to select separate resolution settings for each page of the fax you're sending. This could be useful if you're sending a fax with photos and letters, or some pages with small print and others with normal print. Resolution settings return to STANDARD after the fax is sent.

- 1 Insert original in the ADF or on the scanner glass.
- 2 Press **Function**, **1**, **3**, **4**.
- 3 Press **←** or **→** to select resolution for page 1, and press **Set**.
- 4 Repeat Step 3 for subsequent pages.
- 5 Press **Stop** when you're finished.
- 6 Press **1** if you want to select additional settings. The display returns to the SETUP SEND menu—**OR**—Press **2** if you are finished choosing settings, and go to Step 7. The screen prompts you to enter the fax number you want to call.
- 7 Enter the fax number you're calling.
- 8 Press **Start**.

Setting Up for Polling Transmit

Polling Transmit is when you set up your MFC to wait with an original in the ADF so another fax machine can retrieve it.

1 Place original to be retrieved in the ADF.

2 Press **Function**, **1**, **3**, **7**.

```
POLLED TX:OFF?  
SELECT ← → & SET
```

3 Press **←** or **→** to choose ON and press **Set**.

4 Press **1** if you want to select additional settings. The display returns to the SETUP SEND menu—**OR**—Press **2** if you are finished choosing settings.

5 Press **Start** and wait for the fax to be polled.

7 Auto Dial Numbers and Dialing Options

Storing Numbers for Easy Dialing

You can set up your MFC to do three types of easy dialing: One Touch, Speed Dial, and Groups for Broadcasting of faxes. You can store names with these numbers for easy identification.



If you must wait for another dial tone at any point in the dialing sequence, store a pause at that point in the number by pressing **[Redial/Pause]**. Each key press adds a 3.5 second delay.

Storing One Touch Dial Numbers

You can store 32 fax/phone numbers that you can dial by pressing one key (and **[Start]**). To access numbers 17 to 32, hold down the **Shift** key. When you press a One Touch dial location, the screen displays the name or number as the call is dialed. (See *One Touch Dialing*, page 7-4.)

One Touch keys are not the dial pad keys. They are the 16 keys (numbers 01–32) located on the left side of the control panel.

1 Press **[Function]**, **[1]**, **[5]**, **[1]**.

2 Press the One Touch key where you want to store a number.



(One Touch key **[01]** has been pre-programmed for the Brother fax-back system (USA only). You can override it if you wish.) The screen displays the location you selected.

3 Enter a number (up to 20 digits) and press **[Set]**.

(See *Changing One Touch and Speed Dial Numbers*, page 7-2.)



If you want to enter a pause in the dialing sequence (for example, to access an outside line), press **[Redial/Pause]** as you're entering digits.

Each key press of **[Redial/Pause]** enters a 3.5 second pause when the number is dialed, and a dash appears on the screen.

4 Use the dial pad to enter the name (up to 15 characters) and press **[Set]**—**OR**—

NAME: ENTER & SET

Press **[Set]** to store the number without a name.

(See *Entering Text*, page 4-2.)

5 Press **[←]** or **[→]** to select the type of number and press **[Set]**.

FAX	a fax number
TEL	a telephone (voice) number
FAX/TEL	both fax and telephone number

6 Return to Step 2 to store another number—**OR**—Press **[Stop]** to exit.



If you lose electrical power, numbers stored in memory will *not* be lost.

Storing Speed Dial Numbers

You can store Speed Dial numbers, so you can dial by pressing only three keys (and **Start**). There are 100 Speed Dial locations. (See *Speed Dialing*, page 7-4.)

1 Press **Function**, **1**, **5**, **2**.

2 Use the dial pad to enter a two-digit location (00–99) and press **Set**.

```
SPEED-DIAL? #  
ENTER & SET
```

3 Enter the number (up to 20 digits) and press **Set**.

```
#05:  
ENTER & SET
```

4 Use the dial pad to enter the name (up to 15 characters) and press **Set**.

```
NAME:  
ENTER & SET
```

You can use the chart on page 4-2 to help you enter letters—**OR**—Press **Set** to store the number without a name.

5 Press **Left Arrow** or **Right Arrow** to select the type of number and press **Set**:

FAX a fax number

TEL a telephone (voice) number

FAX/TEL both fax and telephone number

6 Return to Step 2 to store another Speed Dial number—**OR**—Press **Stop** to exit.



Even if you lose electrical power, numbers stored in memory will *not* be lost.

Changing One Touch and Speed Dial Numbers

If you try to store a One Touch or Speed Dial number in a location where a number is already stored, the screen displays the current name stored there, then prompts you to either

```
*01: BROTHER  
1. CHANGE 2. EXIT
```

1 Press **1** to change the number, or press **2** to exit without changing it.

2 Enter a new number and press **Set**.

- If you want to erase the number, press **Clear** when the cursor is to the left of the digits.

- If you want to change a digit, use **Left Arrow** or **Right Arrow** to position the cursor under the digit you want to change, then type over it.

3 Follow the directions from Step 4 for *Storing One Touch Numbers* or *Storing Speed Dial Numbers*.

Setting Up Groups for Broadcasting

Groups allow you to send the same fax message to many fax numbers by pressing only one One Touch Group key (and **Start**). **First**, you'll need to store each fax number as a One Touch or Speed Dial number. **Then**, you can combine them into a Group. *Each Group uses up a One Touch key.* Finally, you can have up to six small Groups, or you can assign up to 131 numbers to one large Group. (See *Broadcasting*, page 7-5.)



You can include *up to* 31 One Touch numbers, and *up to* 100 Speed Dial numbers. If you broadcast to more than the maximum locations available, you will be unable to set up transmissions using Dual Access and the Timer.

(See *Storing One Touch Dial Numbers*, page 7-1 and *Storing Speed Dial Numbers*, page 7-2.)

1 Press **Function**, **1**, **5**, **3**.

2 Select a One Touch key where you wish to store the Group number.
For example, press One Touch key **02** for Group 1.

```
SELECT ONE-TOUCH
```

3 Use the dial pad to enter the Group number and press **Set**.
For example, press **1** for Group 1.

```
SETUP GROUP:GO  
ENTER & SET
```

4 To include One Touch or Speed Dial numbers in the Group, enter them as if you were dialing. For example, for One Touch key **05**, press One Touch key **05**. For Speed Dial location 09, press **Speed Dial**, then press **0**, **9** on the dial pad. The display shows ***05, #09**.

```
G01:*05#09  
ENTER & SET
```

5 When you're finished adding numbers, press **Set**.

6 Use the dial pad and the chart on page 4-2 to enter a name for the group and press **Set**.
For example, NEW CLIENTS

```
NAME:  
ENTER & SET
```

7 Press **Stop** to exit.



You can print a list of all One Touch and Speed Dial numbers. (See Chapter 9, *Printing Reports*.)



If you lose electrical power, numbers stored in memory will *not* be lost.

Dialing Options



When you dial an auto dial number, the screen displays the name you've stored, or, if you haven't stored a name, the fax number you've stored.

Searching Telephone Index

You can search for names you have stored in One Touch and Speed Dial memories. Names are stored alphabetically. (See *Storing One Touch Dial Numbers*, page 7-1 and *Storing Speed Dial Numbers*, page 7-2.)

- 1 Insert the original(s) in the ADF, or on the scanner glass.
- 2 Press **[Tel-index]**, then enter the first letter of the name you're looking for.
- 3 Press **[←]** or **[→]** to search the memory.
- 4 When the screen displays the name you want to call, press **[Start]** to begin dialing.

One Touch Dialing

- 1 Insert the original(s) in the ADF, or on the scanner glass.
- 2 Press the One Touch key of the location you want to call.
- 3 Press **[Start]**.



If you try to use a One Touch or Speed Dial location with no number stored in it, you hear a warning sound, and screen displays NOT REGISTERED. The display returns to normal after 2 seconds.

Speed Dialing

- 1 Insert the original(s) in the ADF, or on the scanner glass.
- 2 Press **[Speed Dial]**, then press the two-digit Speed Dial number.
- 3 Press **[Start]**.

Pause

Press **[Redial/Pause]** to insert a 3.5 second pause between numbers. If you are dialing overseas, you can press **[Redial/Pause]** as many times as needed to increase the length of the pause.

Fax Redial

If you're sending a fax manually and the line is busy, press **[Redial/Pause]** to retry the number.

If you're sending a fax automatically and the line is busy, the machine will redial automatically up to three times at 5 minute intervals.

Broadcasting

Broadcasting is automatically sending the same fax message to multiple fax numbers. Using the **Broadcast** key, you can include Groups, One Touch locations, Speed Dial locations and up to 50 manually dialed numbers. If you did not use up any locations for Groups, access codes or credit card numbers, you can “broadcast” faxes automatically to up to 182 locations. However, available memory will vary with all types of jobs in memory and numbers of locations used for broadcasting. If you broadcast to more than the maximum locations available, you will not be able to set up transmissions using dual access and the timer.

Although the easiest way to broadcast is to press Group keys, you can include One Touch, Speed Dial, and manually dialed numbers in the same broadcast. You must press **Broadcast** between each of these locations. Use the Telephone Index to help you choose the numbers easily. (See *Setting Up Groups for Broadcasting*, page 7-3.) After the broadcast is completed, a Broadcast Report will be printed automatically to let you know the results.

- To stop the broadcasting in progress, press **Stop**. The LCD display asks if you want to cancel all locations or only the location that is being sent.
 - Enter the long dialing sequence numbers as you normally would, but keep in mind that each key counts as one location, so the number of locations you can call becomes limited.
 - If the line is busy while broadcasting, the MFC will redial the number automatically.
 - If the memory is full, press **Stop** to abort the job or press **Start** to send the portion that is in the memory (if more than one page has been scanned.)
- 1 Insert the original in the ADF or on the scanner glass.
 - 2 Enter a number using One Touch, Speed Dial, Group number, Tel-index or the dial pad.
(Example: Group number)
 - 3 Press **Broadcast**. You will be prompted to press the next number.
 - 4 Enter the fax number.
(Example: Speed Dial)
 - 5 Press **Broadcast**.
 - 6 Enter the fax number.
(Example: Manual dialing, using the dial pad.)
 - 7 Press **Start**.

Your MFC will read the originals into memory and then start sending faxes to the numbers you entered.



Previously entered jobs still in memory will be sent first.

Dialing Access Codes and Credit Card Numbers

Sometimes you may want to choose from among several long distance carriers when you make a call. Rates may vary depending upon the time and destination. To take advantage of low rates, you can store the access codes or long-distance carriers as One Touch and Speed Dial numbers. You can store these long dialing sequences by dividing them and setting them up separately in any combination. You can even include manual dialing using the dial pad. The combined number will be dialed in the order you entered it, as soon as you press **[Start]**. (See *Storing One Touch Dial Numbers*, page 7-1.)

For example:

You store “555” on One Touch key **[03]** and “7000” on One Touch key **[02]**. If you press One Touch **[03]**, **[02]** and **[Start]** you will dial “555-7000”. To temporarily change a number, you can substitute part of the number with manual dialing using the dial pad. For example, to change the number to 555-7001 you can press One Touch **[03]** and press **[7]**, **[0]**, **[0]**, **[1]** using the dial pad.



Pause after dialing Speed Dial numbers for the name to be displayed before you enter the next portion of the dialing sequence.

8 Remote Fax Options

Paging and Fax Forwarding



You cannot use Paging and Fax Forwarding at the same time.

To use Paging or Fax Forwarding you must set Fax Storage to ON.

Programming a Paging Number

When Paging is selected, your MFC dials the pager number you've programmed, and dials your Personal Identification Number (PIN) when connected, to activate your pager and let you know you have a fax message in the memory.

- 1 Press **[Function]**, **[1]**, **[7]**, **[1]**.
- 2 Press **[Left]** or **[Right]** until the screen displays **PAGING?** and press **[Set]**.

```
PAGING?  
SELECT < > & SET
```

- 3 Enter your pager phone number (up to 20 digits) followed by **[#]** **[#]** and press **[Set]**. Do not include the area code if it is the same as that of your MFC.

```
PAG#:  
ENTER & SET
```

For example,

[1]**[8]****[0]****[0]****[5]****[5]****[5]****[1]****[2]****[3]****[4]****[#]****[#]**.

- 4 If your pager requires a PIN, enter the PIN, press **[#]**, press **[Redial/Pause]**, enter your MFC telephone number followed by **[#]** **[#]** and press **[Set]**.
For example, **[1]****[2]****[3]****[4]****[5]****[#]****[Redial/Pause]****[1]****[8]****[0]****[0]****[5]****[2]****[1]****[2]****[8]****[4]****[6]****[#]****[#]**.

—OR—

If you do not need a PIN, press **[Redial/Pause]**, enter the fax number of your MFC, then press **[#]** **[#]** and press **[Set]**.

For example,

[Redial/Pause]**[1]****[8]****[0]****[0]****[5]****[2]****[1]****[2]****[8]****[4]****[6]****[#]****[#]**.

- 5 Press **[Stop]** to exit.



You cannot change a Paging number or PIN remotely.

Press **[Redial/Pause]** for each 3.5 second delay, as needed.

Programming a Fax Forwarding Number

When Fax Forwarding is set to ON, your MFC stores the received fax in memory, then dials the fax number you've programmed, and forwards the fax message.

- 1 Press **Function**, **1**, **7**, **1**.
- 2 Press **←** or **→** until the screen displays **FAX FORWARD?** and press **Set**.

```
FAX FORWARD?  
SELECT ← → & SET
```

- 3 Enter the forwarding number (up to 20 digits) and press **Set**.

```
FWD#:  
ENTER & SET
```

- 4 Press **Stop** to exit.

Setting Fax Storage

If you set Fax Storage to ON, you will be able to retrieve fax messages from another location, using Fax Forwarding, Paging, or Remote Retrieval functions. The screen will indicate when you have a fax stored in memory. The memory can store up to 700 pages of faxes.

- 1 Press **Function**, **1**, **7**, **2**.
- 2 Press **←** or **→** to select **ON** (or **OFF**) and press **Set**.

```
FAX STORAGE:OFF?  
SELECT ← → & SET
```

- 3 Press **Stop** to exit.

 If there are faxes in memory when you turn Fax Storage OFF, you must choose to delete them or exit without turning Fax Storage on.

- 4 Press **1**, to erase faxes from memory and to turn Fax Storage off
—**OR**—
Press **2**, to exit without deleting faxes or changing this setting.
(See *Printing a Fax in Memory*, page 5-5.)

```
ERASE ALL FAX?  
1.YES 2.NO
```

Remote Retrieval

You can call your MFC from any fax machine using touch tone, then use the Remote Retrieval Access Code and other button presses to retrieve fax messages.

Changing Remote Retrieval Access Code

Enter your Remote Retrieval Access Code when the MFC picks up your call, so you can access features remotely. The access code is preset to 1 5 9 *, however, you can change your access code. (See *Operation from Extension Telephones*, page 5-5.)

- 1 Press **Function**, **1**, **7**, **3**.
- 2 Enter a three-digit number from 000 to 999 and press **Set**.
The "*" cannot be changed. Do not use the same digits that appear in your Fax Receive Code or Telephone Answer Code.
- 3 Press **Stop** to exit.

Using Remote Retrieval Access Code

- 1 Dial your MFC phone number from a fax machine using touch tone.
 - 2 When your MFC answers, immediately enter your Remote Retrieval Access Code (1 5 9 *).
 - 3 The MFC signals the kinds of messages received:
 - 1 long beep — Fax message(s)**
 - No beeps — No messages**
 - 4 The MFC then prompts you with two short beeps to enter a command. If you wait longer than 30 seconds to enter a command, the MFC hangs up. If you enter an invalid command, the MFC beeps three times.
 - 5 Press **9** **0** to reset the MFC when you're finished.
 - 6 Hang up.
-  If your MFC is set to Manual mode, you can access it by waiting about 2 minutes, then entering the Remote Retrieval Access Code within 30 seconds.

Remote Commands

Follow the commands below to access features remotely. When you call the MFC and enter your Remote Retrieval Access Code (1 5 9 *), the system will signal you with two short beeps to enter a remote command.

Remote Commands	Operation Details												
<p>95 Changing Fax Forwarding/Paging setting</p> <table border="1" data-bbox="219 363 516 834"> <tr> <td data-bbox="219 363 516 403">1</td> <td data-bbox="219 403 516 443">OFF</td> </tr> <tr> <td data-bbox="219 443 516 483">2</td> <td data-bbox="219 483 516 523">Fax Forwarding</td> </tr> <tr> <td data-bbox="219 523 516 563">3</td> <td data-bbox="219 563 516 603">Paging</td> </tr> <tr> <td data-bbox="219 603 516 754">4</td> <td data-bbox="219 754 516 834">FAX FWD No.</td> </tr> <tr> <td data-bbox="219 754 516 794">6</td> <td data-bbox="219 794 516 834">Fax Storage ON</td> </tr> <tr> <td data-bbox="219 794 516 834">7</td> <td data-bbox="219 834 516 874">Fax Storage OFF</td> </tr> </table>	1	OFF	2	Fax Forwarding	3	Paging	4	FAX FWD No.	6	Fax Storage ON	7	Fax Storage OFF	<p></p> <p>If you hear one long beep, the change is accepted. If you hear three short beeps, you cannot change it because the conditions have not been met. (Example: registering paging number.) You can register your fax forwarding number by using 4. FAX FWD NO. (See page 8-6.) Once you have registered the number, your MFC will change automatically to FAX FWD:ON mode. Then retrieve a Memory Status List by entering 961 (see page 8-5) to make sure that the Fax Forwarding number you registered is correct in the List.</p> <p>You can turn FAX STORAGE to ON or OFF.</p>
1	OFF												
2	Fax Forwarding												
3	Paging												
4	FAX FWD No.												
6	Fax Storage ON												
7	Fax Storage OFF												
<p>96 Retrieve a fax</p> <table border="1" data-bbox="219 879 516 1054"> <tr> <td data-bbox="219 879 516 919">1</td> <td data-bbox="219 919 516 959">Memory Status List</td> </tr> <tr> <td data-bbox="219 959 516 999">2</td> <td data-bbox="219 999 516 1038">Retrieve all faxes</td> </tr> <tr> <td data-bbox="219 1038 516 1054">3</td> <td data-bbox="219 1054 516 1054">Erase fax from the memory</td> </tr> </table>	1	Memory Status List	2	Retrieve all faxes	3	Erase fax from the memory	<p></p> <p>Enter the number of a remote fax machine to receive the Memory Status List or stored fax message(s). (See page 8-5.)</p> <p>If you hear one long beep, you can erase fax message(s) from the memory.</p>						
1	Memory Status List												
2	Retrieve all faxes												
3	Erase fax from the memory												
<p>97 Check the Receiving Status</p> <table border="1" data-bbox="219 1099 516 1230"> <tr> <td data-bbox="219 1099 516 1230">1</td> <td data-bbox="219 1230 516 1230">Fax</td> </tr> </table>	1	Fax	<p></p> <p>You can check whether your MFC has received any fax message(s). If yes, you will hear one long beep. If no, you will hear three short beeps.</p>										
1	Fax												
<p>98 Change Answer Mode</p> <table border="1" data-bbox="219 1275 516 1374"> <tr> <td data-bbox="219 1275 516 1315">1</td> <td data-bbox="219 1315 516 1355">EXT. TEL/TAD</td> </tr> <tr> <td data-bbox="219 1355 516 1374">2</td> <td data-bbox="219 1374 516 1374">FAX</td> </tr> </table>	1	EXT. TEL/TAD	2	FAX	<p></p> <p>If you hear one long beep, you can change the Answer Mode. If you hear three short beeps, you cannot change it.</p>								
1	EXT. TEL/TAD												
2	FAX												
<p>90 Exit</p>	<p>After a long beep, you can exit remote control.</p>												

Retrieving Memory Status List

You can retrieve the Memory Status List from a remote fax machine to see if you have any fax messages.

- 1 Dial your fax number.
- 2 When your MFC answers, immediately enter your Remote Retrieval Access Code (1 5 9 *).
- 3 When you hear two short beeps, use the dial pad to press 9 6 1.
- 4 Using the dial pad, enter the number (up to 20 digits) of the remote fax machine where you want the Memory Status List forwarded, and then press # #.

You cannot use * and # as dial numbers. However, if you want to store a pause, press #.

- 5 After you hear your MFC beep, hang up and wait.



Your MFC calls the remote fax machine. The remote fax machine prints the Memory Status List.

Retrieving Fax Messages

- 1 Dial your fax number.
- 2 When your MFC answers, immediately enter your Remote Retrieval Access Code (1 5 9 *).
- 3 As soon as you hear two short beeps, use the dial pad to press 9 6 2.
- 4 Using the dial pad, enter the number (up to 20 digits) of the remote fax machine where you want your fax messages forwarded, and then press # #.



You cannot use * and # as dial numbers. However, if you want to store a pause, press #.

- 5 After you hear your MFC beep, hang up and wait.

Your MFC calls the remote fax machine. The remote fax machine prints your fax messages.

Changing Fax Forwarding Number Remotely

You can change the default setting of your fax forwarding number from a remote fax machine.

- 1** Dial your fax number.
- 2** When your MFC answers, immediately enter your Remote Retrieval Access Code (1 5 9 *).
- 3** When you hear two short beeps, use the dial pad to press 9 5 4.
- 4** Enter the new number of the remote fax machine where you want your fax messages forwarded, and then press ## #.
-  You cannot use * and # as dial numbers. However, if you want to store a pause, press #.
- 5** To retrieve the Memory Status List, when you hear two short beeps, use the dial pad to press 9 6 1.
- 6** Use the dial pad to enter the number of the remote fax machine (up to 20 digits), and then press ## #.
- 7** After you hear your MFC beep, hang up and wait.
Your MFC calls the remote fax machine. The remote fax machine prints the Memory Status List showing the new forwarding number.
- 8** Check the forwarding number.

If the forwarding number is incorrect, return to Step 1 to reset it.

9 Printing Reports

MFC Settings and Activity

You can print the following lists and reports:

1. XMIT REPORT

Choose if you would like a Transmission Verification Report printed after every fax you send.

2. ACT. REPORT

Activity Report lists information about the last 50 incoming and outgoing faxes. TX means Transmit; RX means Receive.

3. ALL DIAL

Lists names and numbers stored in One Touch and Speed Dial memory, in numerical order.

4. TEL. INDEX

ALL DIAL list (above), alphabetically.

5. USER SETTINGS

Lists settings for INITIAL SETUP, SETUP RECEIVE, SETUP SEND, PRINT REPORTS, MISCELLANEOUS and REMOTE FAX OPT.

6. MEMORY STATUS

Lists summary information and amount of occupied memory.

To Print a Report

1 Press **Function**, **1**, **6**.

2 Enter the number of the report you want to print. For example, press **4** to print the TEL-INDEX.

 For the Activity Report, also press **←** or **→** to select PRINT REPORT? and press **Set**.

3 Press **Start**.

4 Press **Stop** to exit.

Transmission Verification (Xmit) Report

You can use the Xmit Report as proof that you sent a fax. This report lists the name or fax number of the receiving party, the time and date of transmission, and if the transmission was successful.



When the feature is OFF, the report is printed only if there's an error during transmission. If the report indicates NG, send the fax again.



When the feature is ON, the report is printed with every fax you send.

If you typically send multiple faxes to the same destinations, you may need a reminder to identify each fax transmission. You can select OFF+IMAGE or ON+IMAGE to print a portion of the first page of the fax message on the report.

- 1 Press **Function**, **1**, **6**, **1**.
- 2 Press **←** or **→** to select OFF, OFF+IMAGE, ON or ON+IMAGE and press **Set**.
- 3 Press **Stop** to exit.

Activity Report Interval

You can set the MFC to print activity reports at a specific interval (6, 12, 24 hours, 2, 4 or 7 days). If you set the interval to OFF, you can print the report by following the steps in the previous section.

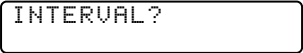
- 1 Press **Function**, **1**, **6**, **2**.
- 2 Press **←** or **→** to display INTERVAL? and press **Set**.

- 3 Press **←** or **→** to choose your setting and press **Set**.
(If you choose 7 days, the screen prompts you to choose a day on which to begin the 7-day countdown.)
- 4 Enter the time to begin printing, in 24-hour format and press **Set**.
(For example, enter 19:45 for 7:45 PM.)
- 5 Press **Stop** to exit.

10 Making Copies

Basic Copy Operation

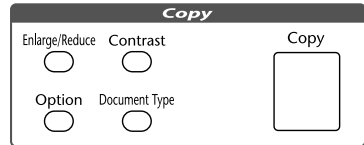
You can use your MFC as a copier, making up to 99 copies at a time. The MFC can stack the copies or collate (sort) them.



Copying One Page

- 1 Place the original in the ADF, or on the scanner glass.
- 2 Press **Copy**, then wait five seconds—**OR**—Press **Copy** again. Do **NOT** pull on the paper while copying is in progress.

COPYING P. 01



To stop copying and eject the original, press **Stop**.

Stacking Multiple Copies (Using the ADF)

Unless you select **SORT**, multiple copies will be stacked (all copies of page 1, then all copies of page 2, etc.).

- 1 Insert the original *face up* in the ADF.
- 2 To stack the copies, press **Copy**.
- 3 Using the dial pad, enter the number of copies you want (up to 99).
- 4 Wait five seconds—**OR**—Press **Copy** again.

COPY:STACKING 01

Sorting Multiple Copies (Using the ADF)

- 1 Insert the original *face up* in the ADF.
- 2 Press **Option**, then press **←** or **→** to select **SORT**, and press **Set**.
- 3 Press **Copy**.
- 4 As needed, use the Copy keys to change the **Contrast**, **Document Type**, and **Enlarge/Reduce** settings.
- 5 Using the dial pad, enter the number of copies you want (up to 99).
- 6 Wait five seconds—**OR**—Press **Copy** again.

COPY: SORTING 01

Single or Multiple Copies (Using the Scanner Glass)

For details about using the Copy keys in Step 5, please see *Copy Options (Temporary Settings)*, page 10-3. **If you want to sort multiple copies, use the ADF.** (See *Sorting Multiple Copies (Using the ADF)*, page 10-2.)

- 1 Lift the Document Cover.

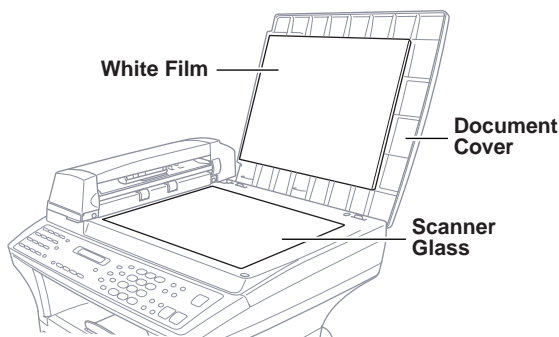

- 2 Using the document guide on the left, center the original *face down* on the scanner glass and close the Document cover.
- 3 Press **Copy**.
- 4 As needed, use the Copy keys to change the **Contrast**, **Document Type**, and **Enlarge/Reduce** settings.
- 5 Using the dial pad, enter the number of copies you want (up to 99).
- 6 Wait five seconds—**OR**—Press **Copy** again.

COPY: STACKING 01

Memory Full Message

If the memory becomes full while you are making copies, the screen displays a message:



MEMORY FULL P.01
ONLINE



COPY TO COPY
STOP TO ABORT

If the MEMORY FULL message appears while you are scanning the first page of your original, press **[Stop]** to cancel. You will need to clear some faxes from memory before you can continue. If you were scanning subsequent page(s), press **[Copy]** to print the scanned pages—**OR**—Press **[Stop]** to cancel.



To gain extra memory, you can turn off Fax Storage (see page 8-2)—**OR**—Print fax messages in memory (see page 5-5).

Copy Options (Temporary Settings)

You can improve your copies by using the Copy keys:

[Contrast], **[Document Type]**, **[Enlarge/Reduce]**, **[Option]**.

These settings are temporary, and the MFC returns to its default settings when you finish copying.

You can try different combinations of settings for best results.

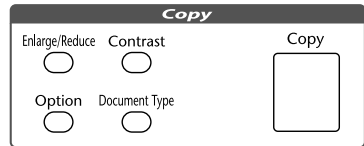

Copy Contrast

If an original is in the ADF or the scanner glass, you can adjust the copy contrast to make copies darker or lighter. The default setting is normal.

- 1 Press **[Contrast]**.
- 2 Press **[←]** to make a copy lighter, or **[→]** to make a copy darker and press **[Set]**.
- 3 Press **[Copy]**.
- 4 Using the dial key pad, enter the number of copies.
- 5 Wait five seconds—**OR**—Press **[Copy]** again.



(Normal)

Document Type

You can select the Copy resolution for your type of original. The default setting is **AUTO**, which is used for documents that contain both text and photographs. **TEXT** is used for documents containing only text. **PHOTO** is used for copying photographs.

- 1 Insert the original in the ADF or on the scanner glass.
- 2 Press **Document Type**.
- 3 Press **←** or **→** to choose document type and press **Set**.
- 4 Press **Copy**.
- 5 Using the dial key pad, enter the number of copies.
- 6 Wait five seconds—**OR**—Press **Copy** again.

```
DOC TYPE:AUTO?  
SELECT ← → & SET
```

Enlarged or Reduced Copies

- 1 Place the original in the ADF or on the scanner glass.
- 2 Press **Enlarge/Reduce**.
- 3 Press **←** or **→** to choose an enlargement or reduction ratio.

```
ELG/RDC:100%  
SELECT ← → & SET
```

You can reduce to **AUTO**, **93%**, **87%**, **75%**, **50%**, or **25%** of the original size

—**OR**—

You can enlarge to **120%**, **125%**, **141%**, **150%**, **200%**, or **400%**

—**OR**—

For more choices select **ZOOM** and press **Set**. Use the dial pad to enter any percentage between **25%** and **400%**.

For example, press **5**, **3** to enter **53%**.

- 4 Press **Copy**.
 - 5 Using the dial pad, enter the number of copies.
 - 6 Wait five seconds—**OR**—Press **Copy** again.
-  Select **AUTO** if you want the MFC automatically to reduce the original to fit on the paper size you programmed (Function 1-2-6).

Selecting Recommended Ratios

Original size is...	Paper size is...	Recommended reduction ratio is...
LETTER DOCUMENT	LETTER LEGAL	100% 100%
A4 DOCUMENT	LETTER	87%
LEGAL DOCUMENT	LETTER LEGAL	75% 100%



You cannot use Legal size paper on the scanner glass.

Special Copy Options

You can sort multiple pages, copy either two or four pages onto one page, and create a poster size copy of a photograph.

4in1

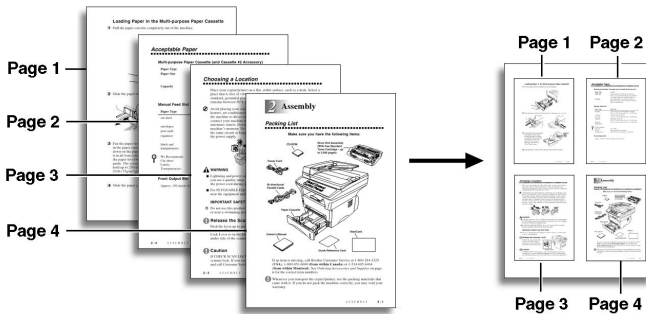

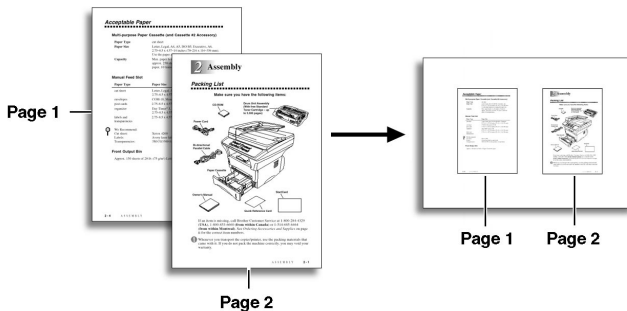

2in1

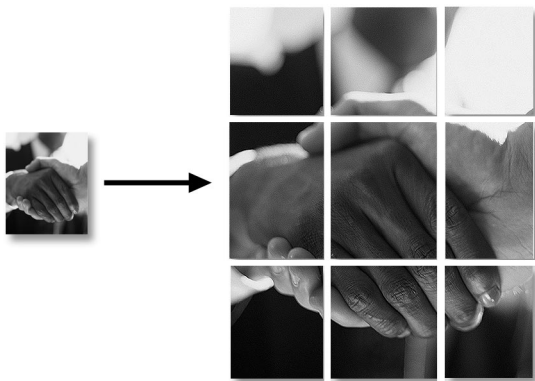

Poster

You can create a poster size copy of a photograph.



 AUTO enlargement or reduction ratio cannot be used if you are copying onto paper that is not the same size as the original. You must use a *pre-set* ratio.

- 1 Insert the original in the ADF or on the scanner glass.

```
OPTIONS: SORT?  
SELECT ← → & SET
```

- 2 Press **[Option]**.
- 3 Press **[←]** or **[→]** to select **SORT**, **2in1**, **4in1** or **POSTER** and press **[Set]**.
- 4 Press **[Copy]**.
- 5 Using the dial pad, enter the number of copies.
- 6 Wait five seconds—**OR**—Press **[Copy]** again.

11 Walk-Up Video Printing

Getting Started

Walk-Up Video Printing lets you use your MFC, connected to your camcorder, digital camera, video game, or VCR, to view a video on the attached equipment. The video signal and the output you create are NTSC (National Television System Committee). This is not compatible with any other standard.

With no originals in the ADF, plug the cable from you video camera's Video Out jack into the MFC's RCA pin jack. Play the video.

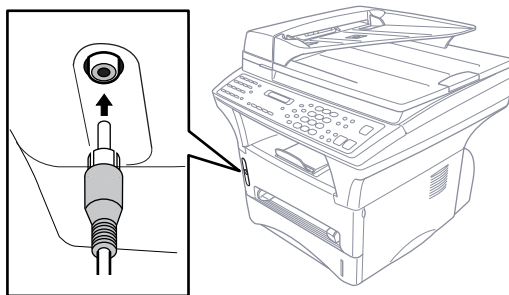

- 🔍 Some camcorders, digital cameras, video games or VCRs do not **correctly** conform with NTSC standards. Then you would not be able to capture video signals.
- 🔍 You can do video printing only on Letter, Legal and A4 size paper.
- 🔍 You can not copy in the scanner glass when you connect video equipment to the machine.

Setting Up Video Print Mode

Whenever you connect video equipment to the Brother machine and turn on the video signal, the machine's Copy keys automatically switch to video printing mode and the screen displays

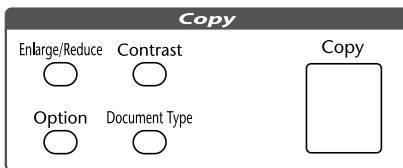

VIDEO:PRESS COPY
CAPTURE READY

-  As soon as you turn off the video equipment or disconnect it, the Copy keys return to normal Copy mode. If you have too much in memory, you cannot access video printing mode.

Black and White Video Printing

- 1 With no originals in the ADF, plug the cable from your video camera's Video Out jack into the Brother machine's RCA pin jack.
- 2 Play the video. When the Brother machine begins receiving the video signals, the machine's screen displays

VIDEO:PRESS COPY
CAPTURE READY

- 3 Press **Copy** when you see the picture you want to capture and print.
- 4 If you want to print multiple pages, use the dial pad to enter the number of copies (up to 99).
- 5 Wait five seconds —**OR**—Press **Copy** again.
- 6 The machine begins printing, and beeps when finished.

-  If the Brother machine is not receiving video signals, **Copy** will not work. However, if there is an original in the ADF, the machine will print a copy.

Changing Default Settings

Press **[Function]** and **[3]** to change default settings for video printing.

DEFAULT SETTINGS

1. Quality	HIGH
2. Video Type	MOVING
3. Print Size	5.75" x 4.25"

By pressing **[Function]**, **[3]** and a number, you can adjust video printing settings as shown in the following chart. Press **[←]** or **[→]** to move through the selection for each setting. Press **[Set]** to save your selection.

Press **[Function]** and **[3]**.

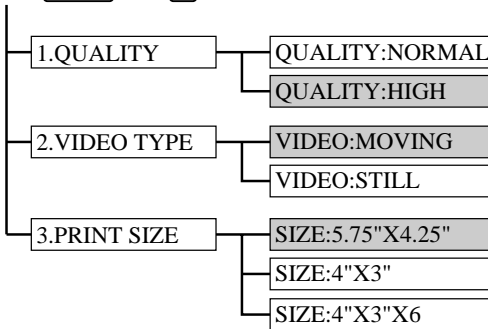

 is default

Setting Video Printing Quality

- 1 Press **[Function]**, **[3]**, **[1]**.

The screen displays **1. QUALITY**.

- 2 Press **[←]** or **[→]** to select a quality and press **[Set]**.

QUALITY:NORMAL

QUALITY:HIGH

- 3 Press **[Stop]** to exit.

Setting Video Type

Before you turn on the video signal, you must set the Brother machine to receive either a moving or a still image. You can watch the video play on the video camera and press **Copy** when you see the frame you want to print.

- 1 Press **Function**, **3**, **2**.
- 2 Press **←** or **→** to select the video type and press **Set**.

VIDEO: STILL

VIDEO: MOVING

- 3 Press **Stop** to exit.

You can press **Clear** in Step 2 to return to the previous step.



If you don't have enough memory to process the selected video image, the print quality may be poor even for a still frame.

Setting Print Size

- 1 Press **Function**, **3**, **3**.
- 2 Press **←** or **→** to select print size and press **Set**.

SIZE: 5.75" X 4.25"

SIZE: 4" X 3"

SIZE: 4" X 3" X 6

Printed Position

① 5.75" x 4.25"

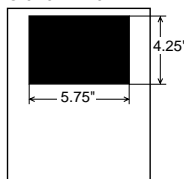

② 4" x 3"

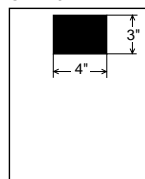

③ 4" x 3" x 6

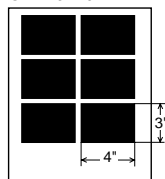

- 3 Press **Stop** to exit.

Video Capture from the PC

Please see *Video Capture from the PC*, page 17-12 or the Multi-Function Link® Pro On-Line Documentation (on CD-ROM 1) for instructions on using your MFC and computer for video frame capture.

12 Setting Up the Brother MFC and PC to Work Together

Using the Brother Machine with Your PC

Multi-Function Link[®] Pro software (MFL Pro) turns your Brother machine into a multi-function center, by enabling you to use your fax machine as a printer and a scanner and to use it to fax from Windows[®] applications in your computer.

The MFC 9600 is a 6 in 1 multi-function center. Install the Multi-Function Link[®] Pro and other Brother software from the bundled CD-ROM.



If you have previously installed Brother Multi-Function Link[®] Pro software for another machine, *uninstall* it first.

Before you install the Multi-Function Link[®] Pro, you must read the README.WRI file in the root directory of the CD-ROM (or Floppy Disks) for important last-minute installation information and troubleshooting tips.

Before You Install Multi-Function Link[®] Pro



If you have a USB cable (For Windows[®] 98 users only), see *Using a USB Cable to Connect the Brother Machine to the PC*, page 12-2.



If you don't have a USB cable, see *Using the Bundled Parallel Cable to Connect the MFC to the PC* page 12-10.

If You Don't Have a CD-ROM Drive

All software is supplied on CD-ROM. If you need a Floppy Disk version for MFC 9600's Multi-Function Link[®] Pro software (PCI4D31 or PCI4D95), call Brother at

USA: 1-888-879-3232
From within Canada: 1-800-668-2768
From within Montreal: 1-514-685-6464

To order the appropriate set of disks, you must tell the Brother Representative the version of Windows[®] you are using and your Brother model number.



Only Multi-Function Link[®] Pro and ScanSoft[™] PaperPort[®] are available on Floppy Disks. Multi-Function Link[®] Pro software is *not* available on Floppy Disks for Windows NT[®] Workstation Version 4.0.

Computer Requirements

The following are the minimum computer requirements you need to set up and operate the MFC as a printer.

CPU	80486/66MHz or higher (Windows® 3.1x or 95) Pentium 75 or Higher (Windows® 98 or Windows NT® Workstation Version 4.0)
RAM	8MB or greater for Windows® 3.1x 8MB or greater for Windows® 95 (16MB recommended) 16MB or greater for Windows® 98 or Windows NT® Workstation Version 4.0 (32MB recommended)
Hard Disk Drive	50MB Available Disk Space
Operating System	Windows® 3.1x, 95/98 or NT® Workstation Version 4.0, DOS environment compatible with your Windows® version



Use only a shield interface cable that is IEEE-1284 compliant, and that is less than 6 feet long (1.8 meters), or a USB cable.

Using a USB Cable to Connect the MFC to the PC (Using Windows® 98 Only)



Please find your Windows® 98 CD-ROM before you begin.



A USB cable is not included with your Brother machine. Before you can set up the USB interface, you must purchase a standard USB cable. Or, if you prefer to set up the bundled parallel cable, please see *Using the Bundled Parallel Cable to connect the MFC to the PC*, page 12-10.



After you have set up the MFC and checked that it is working properly, make sure your MFC is turned on and your PC is turned off.

- 2 Connect the USB cable to both the MFC and the PC.

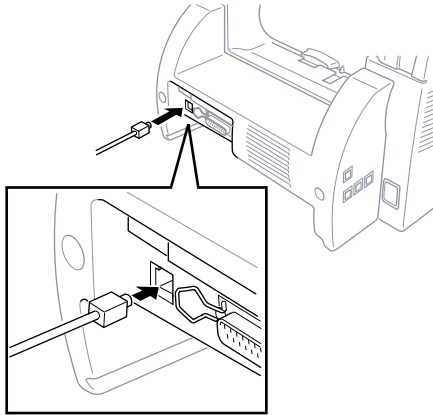

- 3 Turn on your PC.
4 When the Add New Hardware Wizard screen appears, click **Next**.



- 5 Select **(Recommended)** and click **Next**.



Installing Brother Software Using a USB Cable

- 1 Insert the **MFL Pro CD-ROM** into your CD-ROM drive.
- 2 Select **Specify a location** and remove the other check marks, then click **Browse** to locate the file.



- 3 Double-click on the **CD** icon and click on the **Win98usb** folder, then click **OK**.

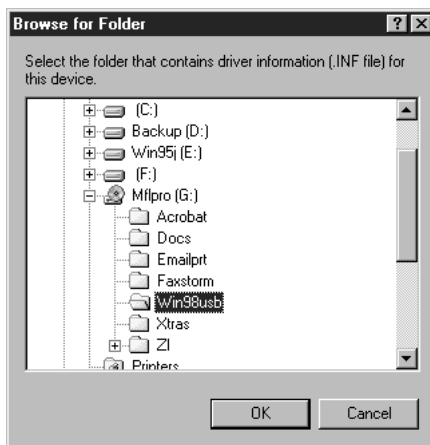

- 4 Make sure **Specify a location** is selected and click **Next**.



- 5 Select **(Recommended)** and click **Next**.



- 6 Confirm the choice is **Brother MFC USB Composite Device** and click **Next**.



-  If the **Insert Disk Wizard** appears, remove the MFL CD-ROM and insert the **Windows 98 CD-ROM** (to get the Windows® standard driver) and click **OK**.

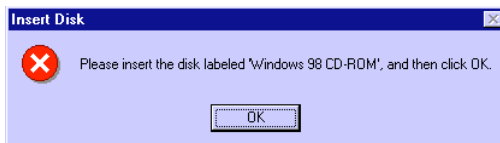

- 7 (If you inserted the **Windows 98 CD-ROM**, remove the CD-ROM and reinsert the **MFL CD-ROM**.) Click **Finish**.



- 8 After the **MFC USB Composite Device** is installed and the Add New Hardware Wizard reappears, click **Next**.



- 9 Select **(Recommended)** and click **Next**.



- 10 Select **Specify a location** and click **Next**.



- 11 Confirm the choice is **Brother MFC USB Port(FaxModem)** and click **Next**.



- 12 When the Add New Hardware Wizard displays the message that installation of the FaxModem and its USB driver is completed, click **Finish**.



Repeat Steps 8-12 two more times (for the Scanner Driver, then Printer Driver).

- 13 After the USB Composite Device, Fax Modem, Scanner and Printer Driver have been installed, select **BRUSB: USB Printer Port** as the printer port and click **Next**.

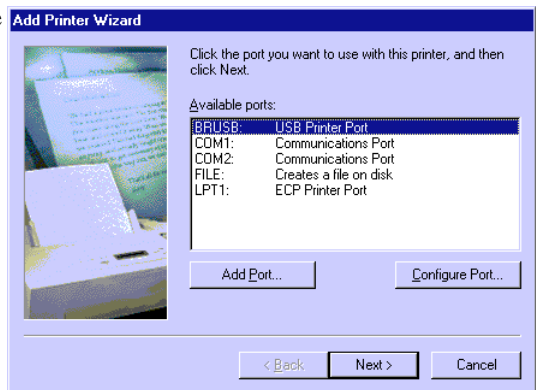

- 14 Type **Brother MFL Pro Printer II** as the name of Printer name and click **Next**.

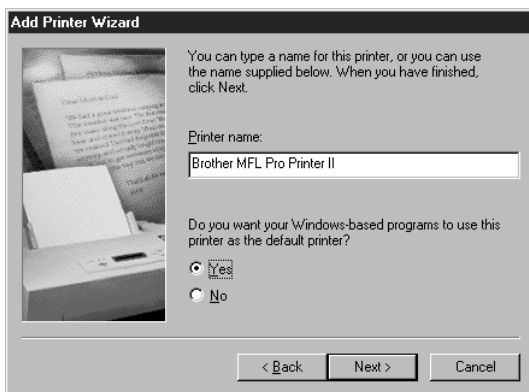

- 15 Select **Yes (Recommended)** to print a Test Page and click **Finish**.

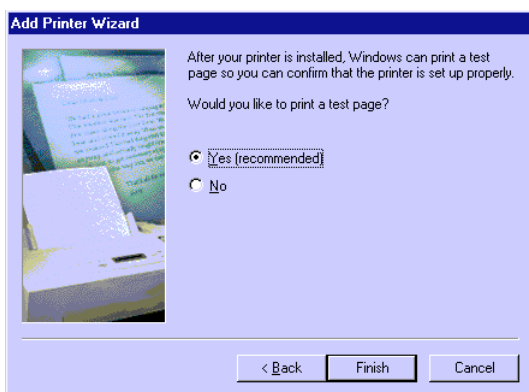

- 16 After test page has printed, click **Yes**.

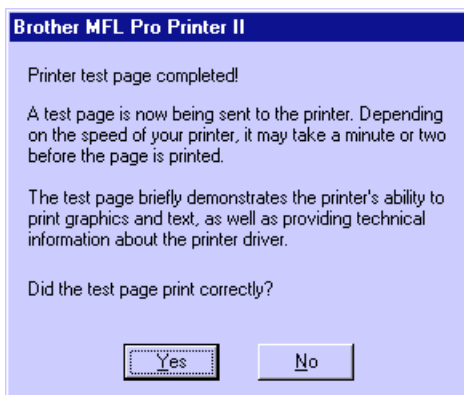

17 When the Add New Hardware Wizard displays the message that the software (drivers for FaxModem, Scanner and Printer) have been installed, click **Finish**.



18 When the Main Menu appears, you can install the Multi-Function Link® Pro software, which includes PaperPort®, TextBridge, True Type Fonts and other applications. (See *Choosing the Software to Install* page 12-11.)

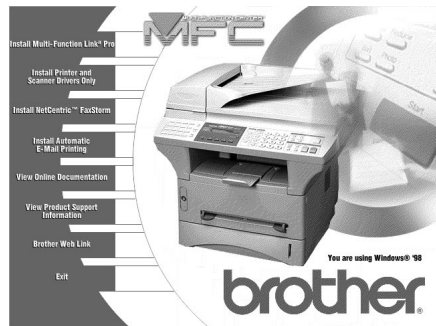

When installing the Multi-Function Link® Pro software, a Question wizard appears, Click **NO** if you are not going to use the MFC with a Parallel Cable.

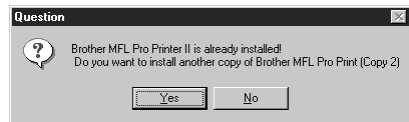

After you install the Multi-Function Link® Pro Software and restart your PC, the MFC Remote Setup dialog box will be displayed on your PC screen. MFC Remote Setup allows you to quickly set up your MFC by taking advantage of the ease and speed of programming on your PC. When you access this application, the settings on the MFC will be displayed on your PC so you can change them as needed and then download them to the MFC.

True Type fonts are the fonts that are used in the Windows® operating systems. If you install the Brother True Type fonts, more types of fonts will be available for Windows® applications.

Using the Bundled Parallel Cable to Connect the MFC to the PC

You must connect the Brother machine to your computer with the bundled bi-directional IEEE-1284 compliant parallel cable.

- 1 Make sure to unplug the machine's power cord from the electrical outlet before connecting the parallel interface cable.
Also, make sure the computer is turned off and unplugged from the electrical power before you connect the interface cable.
- 2 Connect the parallel interface cable to the parallel interface port of the machine and secure the connection with the wire clips.
- 3 Connect the interface cable to the printer port of the computer and secure with the two screws.

For the location of your computer's parallel printer port, see the User's Guide for your computer.

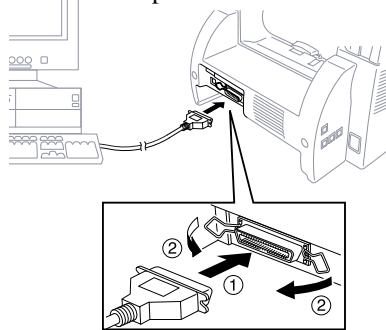

- 4 Before plugging in your computer and turning it on, plug in the electrical cord of the Brother machine.

 If you are using Windows® 95, after you connect Brother machine to Computer, you may see “New Hardware Found Brother MFC9600” during startup.

You can select “Do not install a driver (Windows® will not prompt you again).” and click **OK**, so Windows® will not display this dialog box again —**OR**—

If you see “Update Device Driver Wizard”, Click **Next** to bypass the Windows® Plug and Play Printer Driver screens, followed by **Finish**.

If you are using Windows® 98, you may see the “Add New Hardware Wizard” during startup, follow the instructions from the installer, then click **Next**. Click **Finish** when it appears on the screen.

Choosing the Software to Install

Install Multi-Function Link® Pro

If you want the MFL Pro set of software: Multi-Function Link® Pro, ScanSoft™ PaperPort®, including ScanSoft™ TextBridge®, and Brother scanner driver, printer drivers and True Type Compatible fonts, install:

- Install Multi-Function Link® Pro

Install Printer and Scanner Drivers Only

If you only want to print and scan, you can install only the Brother MFC drivers, install:

- Install Printer and Scanner Drivers Only

Install NetCentric™ FaxStorm

If you want to be able to send Internet faxes from your computer anytime, anywhere without using your Brother machine, install:

- Install NetCentric™ FaxStorm

Install Automatic E-Mail Printing

If you want your e-mail messages automatically to be retrieved from your POP3 server and printed on your Brother machine, install:

- Automatic E-Mail Printing

View Online Documentation

All instructions are in the On-Line Documentation and Help files on the CD-ROM.

- View Online Documentation

View Product Support Information

This is a page of all Brother support numbers.

- View Product Support Information

Brother Web Link

Brother Web Link visits the Internet Brother Home Page on the World Wide Web. You can find more information about Brother products, from product specification sheets to Frequently Asked Questions (FAQ's). You must have service with an Internet service provider.

Exit

Click **Exit** to exit the CD-ROM window, or click **Return** to return to the previous window.

Installing the Brother Software (For Parallel Interface)

IMPORTANT

To install the software using Windows NT® Workstation Version 4.0, you must be logged on as the Administrator. After Multi-Function Link® Pro is installed, restart Windows NT® a second time and again log in as the Administrator, so you can complete the Remote Setup application. After you have completed Remote Setup, log in using your normal User name.

Overview of Basic Steps

1. Insert the Brother CD-ROM into your CD-ROM drive.
2. Enter the command for your version of Windows®, if needed.
3. Select the software option that suits your needs.
4. Follow the installation instructions.

- 1 Insert the Brother CD-ROM into your CD-ROM drive.
- 2 Enter the command for your version of Windows®, if needed.

After you insert the Brother CD-ROM, you must type the appropriate command for your version of Windows®:

- If you are using Windows® 3.1x, from the Program Manager: Click *File*, then *Run*, then type *x:SETUP.EXE*. (“x” is the drive letter for your CD-ROM drive.) This will start the Software Installation program.
- If you are using Windows® 95/98 or Windows NT® Workstation Version 4.0, the Software Installation program appears automatically when you insert the Brother CD-ROM.
- For Windows® 95/98 and Windows NT® Workstation Version 4.0, you can also click *Start* at the Desktop, select *Run* and then enter *x:\SETUP.EXE*. (“x” is the drive letter for your CD-ROM drive.)

The Brother LOGO will be displayed on the screen.

 If you are using Windows NT® 3.51 or earlier, the following error message will appear on the screen:

You are running Windows NT® 3.51 or earlier. Brother MFL Pro does not support this version of Windows NT®. YOU MUST UPGRADE TO WINDOWS NT 4.0 AND REINSTALL MFL Pro!!

 If you are using Windows NT® Workstation 4.0 and you are not logged-in as the Administrator, an error message will appear explaining the problem.

A window appears listing the options:

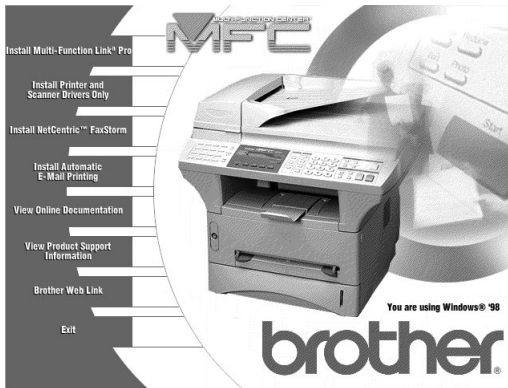

For each application you install, click on that name in the Software Installation window and follow the instructions on the screen. The last step will be to restart Windows® and access the Software Installation window again to install the next application.

3 Click on “Install Multi-Function Link® Pro Software” and follow the prompts on the screen.

 After you install the Multi-Function Link® Pro Software and restart your PC, the MFC Remote Setup dialog box will be displayed on your PC screen. MFC Remote Setup allows you to quickly set up your MFC by taking advantage of the ease and speed of programming on your PC. When you access this application, the settings on the MFC will be displayed on your PC so you can change them as needed and then download them to the MFC.

4 After you finish installing the software, you can click on “On-Line Documentation” to access on-line documentation for Multi-Function Link® Pro and ScanSoft™ PaperPort®.

The On-Line Documentation window appears:

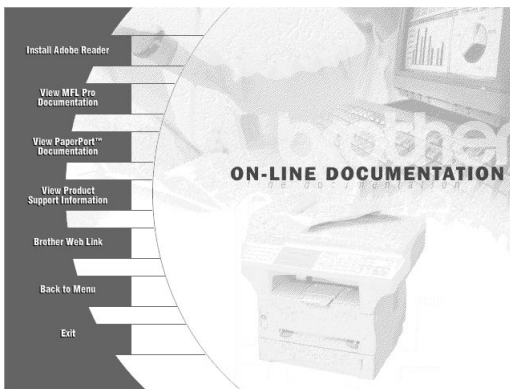

- 5 In the On-Line Documentation window, click on “Install Acrobat Reader” and follow the prompts on the screen. You must install Acrobat Reader before you can view on-line documentation.

Helpful Hints for Windows® 3.1x or Windows® 95/98

- For Windows® 3.1x Only: The installer automatically updates your SYSTEM.INI Windows® file by adding DEVICE=bi-di.386 under the [386Enh] section. If any bi-directional parallel communications device driver has previously been installed, it will be deactivated by this new driver. If you want to use the driver that was previously installed, you should first install this driver, then reinstall your previous driver. However, reinstalling the previous driver will make the Brother machine’s driver inactive.
- The installer makes the installed printer driver the Windows® default.
- The installer automatically sets the printer port to the parallel interface, LPT1 (for Windows® 3.1x) and BRMFC (for Windows® 95/98) and BMFC (for Windows NT® Workstation 4.0).
- During this installation, changes have been made to the **SYSTEM.INI** file. It is necessary to restart Windows® so the changes become effective and the installed bi-directional parallel communications device driver can take effect.

IMPORTANT

Please see the **README.WRI** file in the root directory of the CD-ROM (or floppy disk) for last-minute important installation and troubleshooting information.



To uninstall Multi-Function Link® Pro, click the Uninstall icon in the Brother MFL Pro Program group and follow the instructions on the screen.

Receiving Messages into the PC

To receive faxes into your PC through the MFC: (See *Connecting the MFC to the Computer*, page 12-3 or 12-10.)

- 1 Make sure the MFC is connected to the PC. The PC and the Multi-Function Link[®] Pro Main Menu must be running at all times.
- 2 Load the Multi-Function Link[®] Pro software into your PC. (See *Installing Multi-Function Link[®] Pro Software* (CD-ROM 1) page 12-4 or 12-11.)
- 3 On your PC in the Multi-Function Link[®] Pro software:
 - A Select Setup from the Preferences... pull-down menu in the Main Menu.
 - B Under Answer Mode select Fax only.
 - C Click the OK button.
- 4 Check that the Multi-Function Link[®] Pro mode is ON (see below).

Multi-Function Link[®] Pro Mode

You can switch Multi-Function Link[®] Pro Mode on and off as needed. If you want your fax messages to go directly into your PC, make sure the MF Link setting is ON. If you want faxes to print on your MFC when they arrive, you can switch MF Link mode to OFF. (See *On-Line Documentation for Multi-Function Link[®] Pro* on the Brother CD-ROM and *Using the Multi-Function Link[®] Pro Software* Chapter 16.)

- 1 Press **Function**, **1**, **2**, **0**.
- 2 Press **←** or **→** to select ON (or OFF) and press **Set**.
- 3 Press **Stop** to exit.

13 For DOS Users

How to Use Brother Machine with Your DOS Application Software

Before working with your application software that runs on DOS, check that the Brother machine's name appears in the printer selection of your application software. If the machine is not listed, you must install the printer driver that corresponds to HP LaserJet IIP's emulations.

The following table shows combinations of printer drivers and emulation mode. To get the most out of this machine, you should install an HP printer driver in your application software.

Printer driver supported in your application software	Emulation mode to be selected with the remote printer console program
HP LaserJet IIP™	HP LaserJet IIP emulation mode
HP LaserJet II™	Auto emulation selection

- The best or recommended printer driver is indicated in bold.
- Be sure to choose the proper printer driver in your application software.
- Be sure the printing resolution is set to 300 dpi in your DOS application software.

What Does the Remote Printer Console Do?

The Remote Printer Console (RPC) is a utility program that can run in the DOS environment and comprises the following two programs:

Remote Printer Console Main Program

This program allows you to change various printer settings such as emulation, print quality, fonts, page setup etc., from your computer screen. Since most DOS applications have a Printer Settings menu that overrides the settings made by the RPC, you may not have to use this utility program. This utility program is useful for application software that does not control the printer's settings and features.

Printer Status Monitor Program

This utility program can monitor your printer's status using bi-directional parallel communications. This utility program stays resident in your computer memory (Terminate-and-Stay Resident program) and runs in the background.

Installing the Remote Printer Console

Before you install the program, make sure you have the following hardware and software to install the program:

DOS	Version 3.3 or later
Monitor	EGA/VGA or compatible
Option	Mouse; the mouse driver must be installed. (You can also operate the program with the keyboard.)

Follow these steps to install the remote printer console program:

- 1 Make sure your Brother machine is connected to your computer and it is set to Online.
- 2 Start your computer and go to the DOS prompt. If you are in Windows®, exit and return to the DOS prompt.
- 3 Insert the Brother CD-ROM into your CD-ROM drive.
- 4 At the DOS prompt (C:\>) type *x*: (Substitute the drive letter of your CD-ROM drive for “*x*”) and press Enter.

```
C:\>x:
```

- 5 Type CD DOS and press Enter.

```
x:\>CD DOS
```

- 6 Type RPCSETUP and press Enter.

```
x:\DOS>RPCSETUP
```

- 7 Follow the instructions from the installer.

Using the Remote Printer Console Main Program

Type **C:\RPCX>RPCX** and press the Enter key to start the Remote Printer Console main program.

The Main Screen will appear on your computer screen as shown below.

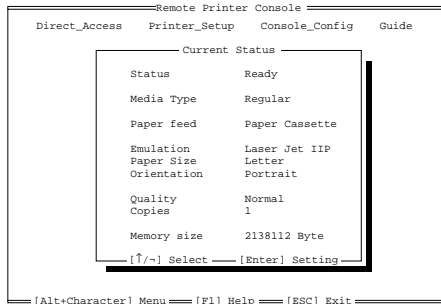

If bi-directional communication is enabled between your computer and MFC when it starts, the RPC gets the current settings information from your MFC. Otherwise, RPC shows its default settings. If you want to change settings, move the cursor to the item you want and select it using the **Enter** and **Cursor** keys. Then, press the **Enter** key to make the selected settings valid.

There are four sub menus. (See table below.) Select the sub menu you want by clicking on it with the mouse, using the cursor keys and the **Enter** key, or by pressing the hot key commands for that sub menu.

Menu	Press the keys	Functions
Direct Access	Alt + D	You can directly control the Brother machine, with Print Form, Reset Printer.
Printer Setup	Alt + P	You can enter the setting mode to change other printer settings, such as, margin settings, continue mode, font and sleep mode.
Console Config	Alt + C	You can change the environment settings for the RPC program: color, Status Monitor configuration, etc.
Guide	Alt + G	You can go to the Guide mode.
Help	F1	You can get Online Help: If you press F1, you can get information on a highlighted item.

Remote Printer Console

Current Printer Status Information

Item	Default	What This Item Does
Media Type	Regular	Selects the media type "Regular," "Thin Paper," "Thick Paper," "Thicker Paper," "Bond Paper" or "Transparency."
Paper Feed	Paper Cassette	Selects the paper feed mode, either "Paper Cassette" or "Manual."
Emulation*1	Laser Jet IIP	Selects "Laser Jet IIP."
Paper Size*1	Letter	Selects the paper size, either "Letter," "Legal," "A4," "Executive," "Monarch," "COM10," "DL," "C5," "B5," "A5," "A6," "JIS B5" or "A4 LONG."
Orientation*1	Portrait	Selects the paper direction, either "Portrait" or "Landscape."
Quality*1	Normal	Selects the print quality, either "Normal" or "Economy."
Copies*1	1 200 pages.	Sets the number of print copies from 1 to 200 pages.

*1 The items can be set in the current printer status information dialog box.

Printer Setup Category

Print Setup Section

Item	Default	What This Item Does
Copies	1	Sets the number of print copies from 1 to 200 pages.
Quality	Normal	Selects the print quality to either "Normal" and "Economy."
Emulation	Laser Jet IIP	Selects "Laser Jet IIP."

Page Setup Section

Item	Default	What This Item Does
Left Margin	*2	Sets the Left Margin value (0-145) columns.
Right Margin	*2	Sets the Right Margin value (0-155) columns.
Top Margin	0.5" or 0.33"	Sets the Top Margin 0", 0.33", 0.5", 1", 1.5" or 2".
Bottom Margin	0.5" or 0.33"	Sets the Bottom Margin 0", 0.33", 0.5", 1", 1.5" or 2".
Line / Page	*2	Sets the lines/pages (5-128).
Xoffset	0	Sets the Xoffset (vertical) value from -500 to 500 dots.
Yoffset	0	Sets the Yoffset (horizontal) value from -500 to 500 dots.

*1 These values (except Yoffset and Xoffset) are overridden by settings within your application software.

*2 These values depend on the paper size settings.

Font Configuration

Item	Default	What This Item Does
Font Source	Internal	"Internal"
Font name	Brougham10	Selects a font from any of the printer's internal fonts (Brougham 10, 12 and Letter Gothic16.66).
Pitch	10	Selects the font size of the selected font. If you selected the Brougham or LetterGothic font, Pitch is shown in the selection box.
Symbol Set	PC8	Selects the symbol set.

Other Configuration

Item	Default	What This Item Does
Auto LF	Off	Selects Auto LF "On or Off"
Auto CR	Off	Selects Auto CR "On or Off"
Auto Wrap	Off	Selects Auto Wrap "On or Off"
Auto Skip	On	Selects Auto Skip "On or Off"

Console Configuration Category

File	Function
Environment	Sets the Buzzer on/off, Color for Remote Print Console
Status Monitor	Sets the hot-key for waking-up the RPC.

For more information on RPC, see the Help Information within the program.

Using the Printer Status Monitor Program

Type **C:\RPCX>STMX** and press the **Enter** key to make the Printer Status Monitor Program stay resident in your computer memory. If there are any changes to the printer status, it displays a message on your computer screen.

If the Printer Status Monitor program stays resident in your computer, you can monitor the printer status on your computer screen immediately by using the hot-key (**Ctrl+Alt+R**).

To remove the Printer Status Monitor program from your computer memory, type **C:\RPCX>STMX/R** and press the **Enter** key.

The RPC works in the environment where your Brother machine is directly connected to your computer. If you are using printer buffer switches that do not support bi-directional communication between the Brother machine and computer, the program works only in the PC to machine direction and cannot receive Brother machine status information.

The program does **NOT** work with Brother machines on a network.

If the RPC conflicts with some application software, exit your application software and then run the RPC.

The RPC may work in the DOS-compatible box screen mode of Windows®. However, it is recommended that you completely exit from Windows® to the DOS prompt before using the RPC.

The Printer Status Monitor and some other Terminate-and-Stay programs cannot coexist in the computer's memory. If they don't work properly together, use them one at a time. You can suspend the Printer Status monitor with any of the following methods or commands.

Type **C:\RPCX>STMX/R** and press the Enter key. Hold the space bar down while executing the **AUTOEXEC.BAT** file at **DOS** startup to prevent the status monitor from being loaded as a TSR program.

14 Using the Brother MFC as a Printer

Special Printing Features

Windows® Printing

The dedicated printer driver and TrueType™ compatible fonts for Microsoft® Windows® 3.1x, 95/98 and Windows NT® Workstation Version 4.0 are available on the CD-ROM supplied with your machine. You can install them easily into your Windows® system using our installer program. The driver supports our unique compression mode to enhance printing speed in Windows® applications, and allows you to set various printer settings, including economy printing mode and custom paper size.

Popular Printer Emulation Support

The machine supports HP LaserJet IIP printer emulation mode. If you use DOS application software, or Windows® 3.0 or earlier, you can use HP LaserJet IIP emulation mode for printer operations. (Use the Remote Printer Console program to set the printer emulation.)

Remote Printer Console Program for DOS

The MFL Pro CD-ROM supplied with your machine includes the utility program Remote Printer Console (RPC). When you operate your computer in the Disk Operating System (DOS) environment, RPC lets you easily change the Brother machine's default settings (such as fonts, page setup, emulations, etc.).

RPC also provides a status monitor Terminate-and-Stay Resident (TSR) program. It runs in the background and monitors the printer status as it reports the current status or errors on your PC screen.

Bi-directional Parallel Interface

The Brother machine's parallel interface enables it to send memory and printer setup information to the computer.

Enhanced Memory Management

The Brother machine has its own Data Compression Technology, which automatically compresses graphic data and downloads font data efficiently into the machine's memory. With the machine's standard memory, you can avoid memory errors and print most full-page, 600 dpi graphic and text data, including larger fonts.

Printing From Your PC

Multi-purpose Paper Cassette

The machine's multi-purpose paper cassette can be adjusted to feed many sizes of paper: letter, legal, A4, B5 and A5 plain paper. When the machine receives print data from your computer, it loads paper from the paper cassette. Insert the sheet of paper with the side you wish to print on face down in the paper cassette.

- Select the print command from your PC.

Your PC sends a print command and data to the machine. The machine displays the date and time and RECEIVING DATA. If there are more pages, the machine begins to print the next page automatically. When printing is finished, it returns to online status.



You may select the proper paper source, paper size, and page orientation in your application software.

If your application software does not support your custom paper size, select the next larger paper size. Then adjust the print area by changing the right and left margins in your application software. (See *Acceptable Paper*, page 2-5.)



Use the manual feed slot for envelopes, labels, transparencies, card stock or thicker paper.

Two-Sided Printing (Manual Duplexing)

The supplied printer drivers for Windows® 3.1x, 95/98 and Windows NT® Workstation Version 4.0 enable manual duplex printing. (For more information, see the Help screen for the printer driver.)

Please select LPT1 on the printer driver.

The machine prints all the even-numbered pages on one side of the paper first. Then, the Windows® driver instructs you (with a pop-up message) to reinsert the paper. Before reinserting the paper, straighten it well, or you may get a paper jam. Very thin or very thick paper is not recommended.

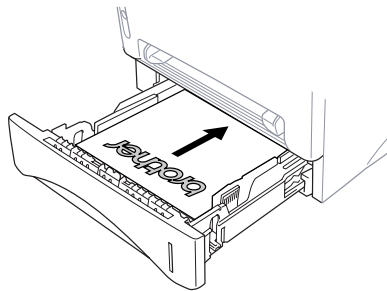

! Caution

When you use manual duplexing, it is possible that a paper jam may occur or the print quality might not be satisfactory. (See *Paper is Jammed in the Multi-purpose Paper Cassette*, page 22-6.)

Front Output Bin

The machine ejects paper with printed surfaces *face down* into the output bin in the front of the machine. Unfold the output bin extension to support the printed pages.

 To prevent the possibility of transparencies smudging as they stack in the output bin, remove each transparency after it exits.

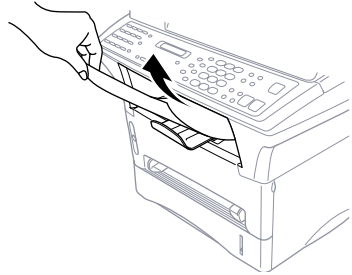

Manual Feed Slot

Your machine has a manual feed slot above the paper cassette. You can load envelopes and special print media *one at a time* into this slot. You do not have to remove paper from the paper cassette. (For information about *Acceptable Paper*, see page 2-5.) Insert the sheet of paper with the side you wish to print on face up in the manual feed slot.

Use the manual feed slot to print or copy on envelopes, labels, card stock or thicker paper.

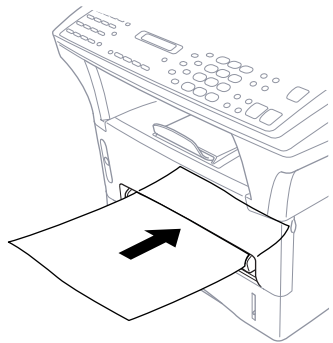

Loading One Sheet of Paper

You do not have to choose Manual Feed in the Setup dialog box of your printer driver. Insert the sheet of paper for Portrait (vertical) or Landscape (horizontal), with the side you wish to print on face up in the manual feed slot.

- 1 Align the paper at the center of the manual feed slot and insert it all the way.
- 2 Adjust the paper guides to the width of the paper.

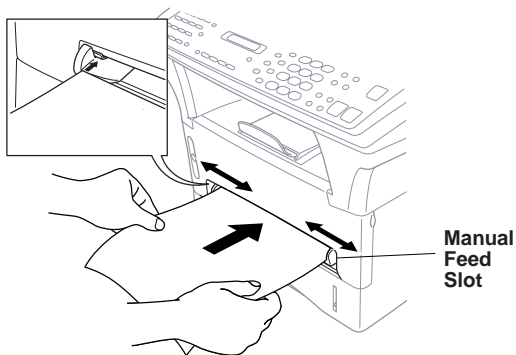

Loading More than One Sheet of Paper

- 1 Open the Setup dialog box of the Windows® printer driver and select Manual Feed in the Paper Source section. Follow Steps 1 and 2 above to load the first page. The machine starts printing automatically.
- 2 After the first page is printed, the screen displays:
Insert the next sheet of paper to resume printing.
- 3 Repeat Steps 1 and 2 until you have finished printing.

```
MANUAL FEED  
PRESS FF/CONT
```



When you use manual feed slot, it is best to first press **Print Priority**. This allows you to print PC data without interruption from incoming faxes. (Incoming faxes will be stored in the machine's memory.)

- To stop or clear the manual feed, turn the machine offline by pressing the **On/Off Line** key, then press **Shift** and **Test/Reset**—**OR**—Stop it with a PC command.



If you do not select Manual Feed, and insert a page in the manual feed slot, the machine will load the first page from the manual feed slot and subsequent pages from the paper cassette.

Printing on Thicker Paper and Card Stock

When the rear cover is lifted up, the machine has a straight paper path from the manual feed slot to the rear of the printer. Use this paper feed and output method when you want to print on envelope, thicker paper or card stock.

- 1 Select manual feed mode in the printer driver.
- 2 Send the print data as usual.
- 3 Lift up the rear cover at the rear of the machine.

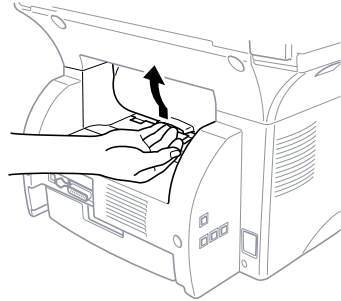

- 4 Adjust the manual feed paper guides to the width of the paper you are using.
- 5 Insert a single sheet of paper into the manual feed slot until the front edge touches the paper feed rollers. Let go of the paper as the machine pulls it into position.
- 6 After the machine ejects the printed page, return to Step 5 to insert the next sheet of paper. The machine will wait until you insert the next sheet of paper. Repeat Steps 5 and 6 for each page to be printed.
- 7 When you have finished printing, close the rear cover of the machine.

 *To prevent the possibility of transparencies smudging as they stack in the output bin, remove each transparency after it exits.*

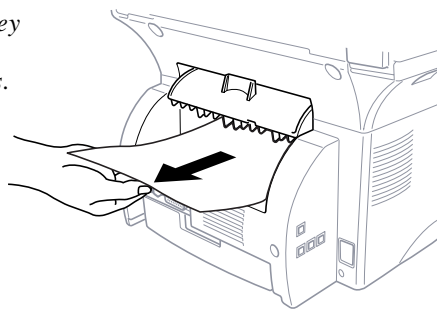

Simultaneous Printing/Faxing

Your machine can print data from your computer while sending or receiving a fax, or while scanning information into the computer. However, when the machine is copying or receiving a fax on paper, it pauses the PC printing operation, and resumes when copying or fax receiving is complete. Fax sending and receiving continues during PC printing/copying. (See *Acceptable Paper*, page 2-5.)

Choosing Acceptable Paper

We recommend that you test paper (especially special sizes and types of paper) on the machine before purchasing large quantities.

- Avoid feeding labels with carrier sheets exposed, or your machine will be damaged.
- Avoid using coated paper, such as vinyl coated paper.
- Avoid using preprinted or highly textured paper.

For optimum printing, use a recommend type of paper, especially plain paper and transparencies. For more information on paper specifications, consult your nearest authorized sales representative or the place where you purchased your machine.

- Use label or transparencies that are designed for use in *laser* printers.
- For the best print quality, we recommend using long-grained paper.
- If you are using special paper, and the paper has problems feeding from the paper cassette, try again using the manual feed slot.
- You can use recycled paper in this machine.

Printer Operation Keys

On/Off Line Key

This key toggles the machine's On Line and Off Line print status, which appears on the display. If you press this key while printing, the machine stops printing and goes off line. Press **[On/Off Line]** again to resume printing.

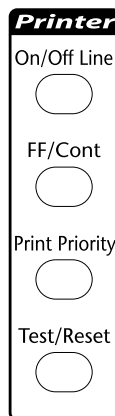

FF/Cont Key

This key sets the machine to Form Feed and Continue.

When the screen displays REMAINED DATA, press **[On/Off Line]** to turn machine offline, then press **[FF/Cont]**. The machine prints any data remaining in its memory.

If an error occurs, such as MEMORY FULL, press **[FF/Cont]** to clear the error and continue operation.

If you press **[FF/Cont]** while the screen displays MANUAL FEED, the machine stops feeding paper from the manual feed slot and starts feeding paper from the paper cassette.

Print Priority Key

When you press **[Print Priority]**, the machine enters printer mode and will not print faxes on paper. Instead, faxes are stored in memory until you press **[Print Priority]** again or when printing is finished.

Test/Reset Key

You can print a test sample page. Press **[On/Off Line]**, then press **[Test/Reset]** (the machine cannot print a test sample page if it is online). The machine prints a test sample page.

You can also clear data from the memory and reset printer default settings. Press **[On/Off Line]**, press **[Shift]** and **[Test/Reset]** at the same time; all data is cleared from the memory.

Printing the Internal Font List

You can print a list of the machine's internal (or resident) fonts to see how each font looks before you select it.

- 1 Press **Function**, **2**, **1**, **1**.
- 2 Press **Start**. The machine prints the list.
- 3 Press **Stop** to exit.

Printing the Print Configuration List

You can print a list of current printer settings.

- 1 Press **Function**, **2**, **1**, **2**.
- 2 Press **Start**. The machine prints the settings.
- 3 Press **Stop** to exit.

Restoring Factory Default Settings

You can return the machine to original factory settings. Permanent fonts are restored, but macros are cleared. You can change user settings using the Remote Printer Console program. (See page 14-1.)

- 1 Press **Function**, **2**, **2**, **1**.
- 2 Press **1** to restore the factory settings
—OR—Press **2** to exit without making a change.
- 3 Press **Stop** to exit.

```
1.RESET 2.EXIT
```

Printing PC Data in Hexadecimal

You can print data as hexadecimal values to check data errors and problems. If you select HEX DUMP MODE, all PC data is printed hexadecimal. To turn hexadecimal mode off, press **On/Off Line** then **Shift** and **Test/Reset** at the same time.

- 1 Press **Function**, **2**, **2**, **2**.
- 2 Press **1** to set PC to hexadecimal mode
—OR—Press **2** to exit without making a change.
- 3 Press **Stop** to exit.

```
1.SET 2.EXIT
```

15 Using the Windows® Based Brother Control Center

(For Windows® 95/98 and NT® 4.0 Only)

Brother Control Center

The Brother Control Center is a software utility that pops up on the PC screen whenever paper is placed in the automatic document feeder. This allows you to quite easily, with very few mouse clicks, access the most frequently used scanning applications. Using the Control Center eliminates the need to manually launch the specific applications.

The Brother Control Center provides three categories of functions:

1. Scan directly to a file, E-mail, word processor or graphic application of choice
2. Enhanced copy functions, such as Two on One Copying
3. PC Faxing using the Brother MFL Pro PC Fax software





AutoLoad the Brother Control Center

The Control Center is initially configured to automatically load each time Windows® is started. When the Control Center is loaded, the Control

Center  icon will appear in the task bar. If you don't want the Control Center to load automatically, you can turn off AutoLoad.

How to Turn Off AutoLoad

- 1 Left click the Control Center  icon and click **Show**.
- 2 When the Control Center icon appears, left click on the Smart Click  Control Center button. A dialogue box with a check box labeled “AutoLoad Pop-up” will appear:

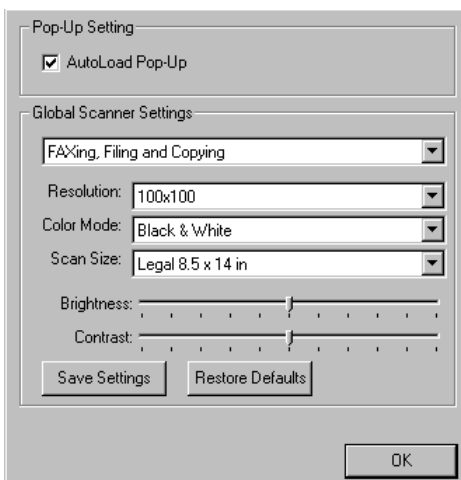

- 3 Uncheck the AutoLoad Pop-Up option.

Brother Control Center Features

Auto Configuration

During the installation process the Control Center checks your system to determine the default applications for E-mail, word processing and graphics viewer/editor. For example, if you are using Outlook as your default E-mail application, the Control Center automatically will create a link and a scanning application button for Outlook.

You can change a default application by right clicking on any of the scan buttons in the Control Center and selecting a different application. For example, you can change a scan button from MS Word

 to MS Word Pad  by changing the application that is listed for the Word Processor.



Scanning Operations

Scan to File—allows you to scan directly to a disk file with two mouse clicks. You can change the file type, destination directory and file name, as needed.

Scan to E-mail—enables you, with just two mouse clicks, to scan a picture or text document directly into an E-mail application as a standard attachment. You have the option of selecting the file type and resolution for the attachment.

Scan to Word Processor—enables you to scan a text document, run ScanSoft TextBridge OCR and insert the text original (not graphic image) into a word processing file with just two mouse clicks. You have the option of selecting the destination word processing program, such as Word Pad, MS Word, Word Perfect, etc.

Scan to Graphic Application—allows you to scan an image directly into any graphic viewer/editor application. You can select the destination application, such as MS Paint or Corel PhotoPaint.

Copy Operations

Copy—allows you to use the PC and any Windows® printer driver for enhanced copy functions. You can scan the page on the Brother MFC and print the copies using any of the features of the Brother MFC printer driver—OR—you can direct the copy output to any standard Windows® printer driver installed on the PC.

Two on One Copy—allows you to use the Two on One page feature of the Brother printer driver to copy two original pages onto a single output page. This feature creates a thumbnail of each page and prints both images on a single page.

PC Fax Operation

Send a Fax—allows you to scan a picture or text original and automatically send the image as a fax from the PC using the Brother MFL Pro fax software.

Scanner Settings for Scan, Copy and PC Fax Buttons

When the Pop-Up screen is displayed, you can access the Scanner Settings window.

Click the Smart Click  icon at the top right of the Brother Control Center screen—OR—Click the **Modify Settings...** button on any of the Configuration screens.

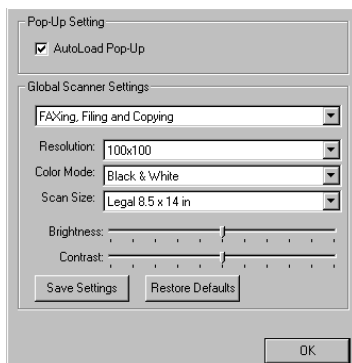

Global Settings

AutoLoad Pop-Up—Click this checkbox if you want Brother MFL Control Center to load when you boot your computer.

Setting Up the Scanner Configurations

The Pop-Up application stores eight different scanning modes. Each time you scan an original, you will choose the most appropriate scanning mode from the following:

Faxing, Filing and Copying

Text for OCR

Photos

Photos (High Quality)

Photos (Quick Scan)

Custom

Draft Copy

Fine Copy

Each mode has its own set of stored settings. You can keep the factory default settings or change them at any time:

Resolution—Select the scanning resolution you most frequently use.

Color Mode—From the pull-down list, select

Scan Size—From the pull-down list, select

Brightness—Slide the adjuster from 0% to 100%

Contrast—Slide the adjuster from 0% to 100%

Click **OK** to save your changes. If you make a mistake or later decide to return to the original default setting, just click the **Restore Defaults** button when the scanning mode is displayed.

To access the Scanner Configurations screen:

- 1 Place the original in the ADF.
- 2 Right-click the appropriate Control Center button to display *Configurations...*, then click it. The configuration screen for that **Control Center** button will appear.
- 3 To save your settings, press the **OK** button, or To return to the factory default settings, press the **Restore Defaults** button.

Perform an Operation from the Control Center Screen

If you see this screen it means you left-clicked a button in the Control Center window without first placing an original in the ADF.

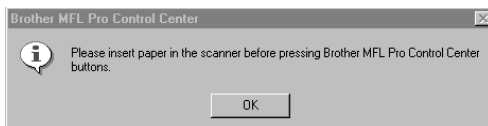

Place the original in the Brother machine's ADF, then click **OK** to return to the Control Center screen.

Scan to File

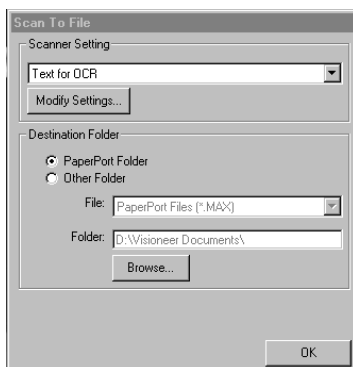

Scanner Settings

From the pull-down list, select the scanning mode that is appropriate for the type of file: Faxing, Filing and Copying; Text for OCR; Photos; Photos (High Quality); Photos (Quick Scan); Custom; Draft Copy or Fine Copy.

To change any of the settings for that mode, click the **Modify Settings...** button.

Destination Folder

PaperPort Folder—Select this checkbox to scan the original into your PaperPort folder.

Other Folder—Select this checkbox, to scan the original as another file type and/or into another directory/folder.

File—If you selected Other Folder, from the pull-down list select the type of file:

- PaperPort Files (*.MAX)
- Self Viewing Files (*.EXE)
- PaperPort 5.0 Files (*.MAX)
- PaperPort 4.0 Files (*.MAX)
- PaperPort 3.0 Files (*.MAX)
- Windows Bitmap (*.BMP)
- PC Paintbrush (*.PCX)
- Multi-page PCX (*.DCX)
- JPEG Image Files (*.JPG)
- TIFF-Uncompressed (*.TIF)
- TIFF Group 4 (*.TIF)
- TIFF Class F (*.TIF)
- Multi-Page TIFF-Uncompressed (*.TIF)
- Multi-Page TIFF Group 4 (*.TIF)
- Multi-Page TIFF Class F (*.TIF)
- PDF Files (*.PDF)
- Portable Network Graphics (*.PNG)
- FlashPix (*.FPX)

- HFX Fax Files (*.HFX)

To Search your system for the directory and folder you want, click the **Browse...** button. Click **OK** to save your settings.

Send Scan to E-mail

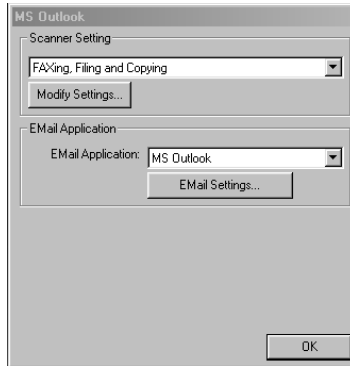

Scanner Settings

From the pull-down list, select the scanning mode that is appropriate for the type of file: Faxing, Filing and Copying; Text for OCR; Photos; Photos (High Quality); Photos (Quick Scan); Custom; Draft Copy or Fine Copy.

To change any of the settings for that mode, click the **Modify Settings...** button.

Email Application

Email Package—From the pull-down list, select your E-mail application.

Email Settings—Click the **EMail Settings...** button to set up links. The Links Preferences window will appear:

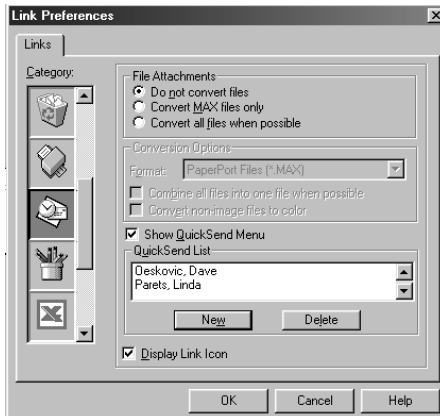

File Attachments

Do not convert files—Click this checkbox if you do not want to change the file type of attachments. The Conversion Options will not be available (grayed).

Convert MAX files only—Click this checkbox if you want to convert only attachments that are PaperPort files.

Convert all files when possible—Click this checkbox if you want to change the file type of all attachments.

Conversion Options

Format

Combine all files into one file when possible—Click this checkbox to combine all files of the same type into one file.

(For Brother Color Models Only) *Convert non-image files to color*—Click this checkbox to convert all files that have been processed through OCR to color.

Show QuickSend Menu

Click this checkbox if you want the Select QuickSend Recipient window to be displayed when you choose Scan to E-mail. This feature works only with MAPI type E-mail applications, such as Microsoft Exchange, Microsoft Outlook and Eudora.

QuickSend List

You can create a list of Email names and addresses for quick selection. Click the **New** button to add a name(s) to your QuickSend list. Your Email phone book listing is displayed, so you can select stored names or create new ones:

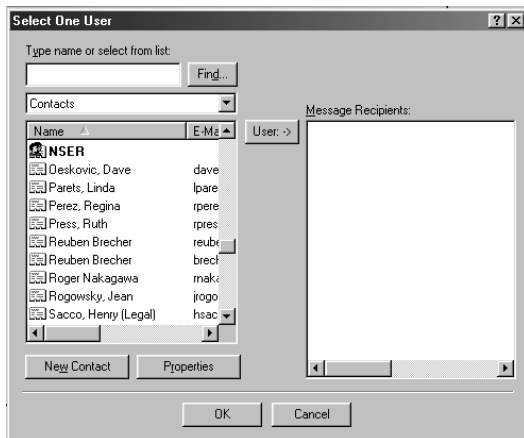

Highlight the name(s) you want to add to your list, click the **User** button, then click **OK** to return to the Link Preference window.

From the Link Preference window, you can remove a name from the QuickSend list, highlight the name and clicking the **Delete** button.

Send Scan to Word Processor

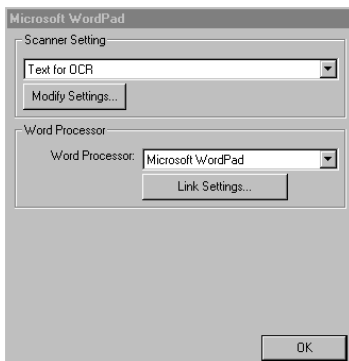

Scanner Settings

From the pull-down list, select the scanning mode that is appropriate for the type of file: Faxing, Filing and Copying; Text for OCR; Photos; Photos (High Quality); Photos (Quick Scan); Custom; Draft Copy or Fine Copy.

To change any of the settings for that mode, click the **Modify Settings...** button.

Word Processor

Word Processor—From the pull-down list, select the word processor you want to use.

Click the **Link Settings...** button to display a screen to set up a link to the version of OCR and document format that you want to use:

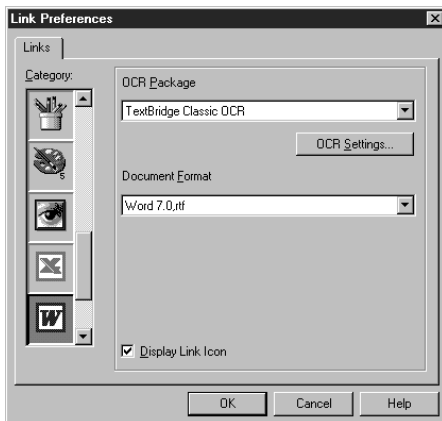

OCR Package—From the pull-down list, select *TextBridge Classic OCR* if you want to use the OCR package that was installed with the Brother software.

Click the **OCR Settings...** button to choose how the OCR application will read the pages you scan into your word processor application.

The Preferences window will appear:

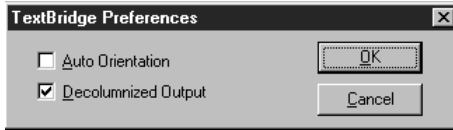

Select your setting and click **OK**.

- *Auto Orientation*—Check this checkbox if you want your word processor application to read the page as it is set up.
- *Decolumnized Output*—Check this checkbox if you want your word processor application to read across the entire page from left to right.
- *Document Format*—From the pull-down list, select the file format you want to use for your word processor or text documents.

User Defined Button



Scanner Settings

From the pull-down list, select the scanning mode that is appropriate for the type of file: Faxing, Filing and Copying; Text for OCR; Photos; Photos (High Quality); Photos (Quick Scan); Custom; Draft Copy or Fine Copy.

To change any of the settings for that mode, click the **Modify Settings...** button.

Target Application

Application—From the pull-down list, select the application you want to add to this Pop-Up screen.

Click the **Custom Link Settings...** button to set up links for your user-defined application.

Copy / Two on One Copy

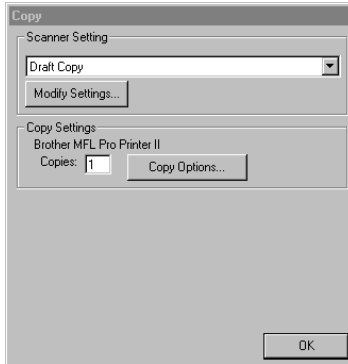

Scanner Settings

From the pull-down list, select the scanning mode that is appropriate for the type of file: Faxing, Filing and Copying; Text for OCR; Photos; Photos (High Quality); Photos (Quick Scan); Custom; Draft Copy or Fine Copy.

To change any of the settings for that mode, click the **Modify Settings...** button.

Copy Settings

Brother MFL Pro Printer II

Copies—Enter the number of copies you want to print.

To change the copy options, click the **Copy Options...** button.

Click the **OK** button to save your Copy settings.

Send a Fax

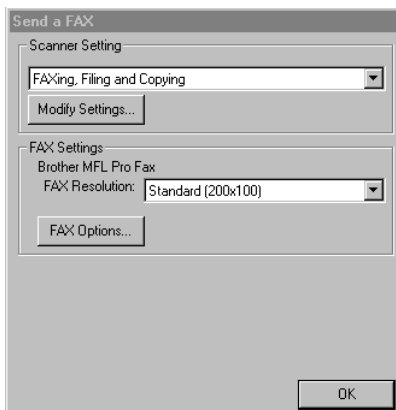

Scanner Settings

From the pull-down list, select the scanning mode that is appropriate for the type of file: Faxing, Filing and Copying; Text for OCR; Photos; Photos (High Quality); Photos (Quick Scan); Custom; Draft Copy or Fine Copy.

To change any of the settings for that mode, click the **Modify Settings...** button.

FAX Settings

Brother MFL Pro Fax

FAX Resolution—Click the pull-down arrow to choose the fax resolution you want:

- Standard (200x100)
- Fine (200x200)
- SuperFine (200x400)

To change the fax options, click the **FAX Options...** button.

Click the **OK** button when you are ready to save your FAX settings.

The MFL Pro Fax on COM1 Properties screen appears:

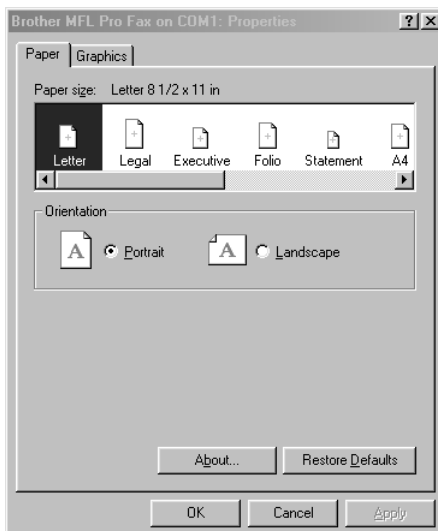

Select the *Paper Size, Orientation* (Portrait or Landscape) and click **OK**.

To return to the factory default settings, click the **Restore Defaults** button.

16 Using Multi-Function Link[®] Pro Software

Introduction

This chapter outlines the basics of the Brother software, so you can get started using the Multi-Function Link[®] Pro software. Detailed installation and setup instructions are in the *On-Line Documentation* section of the Brother CD-ROM 1 that is included with your MFC.

Check the online README.WRI file in the root directory of the CD-ROM 1 for last-minute important information and troubleshooting tips that were not included in the On-Line Documentation.

Multi-Function Link[®] Pro software for your MFC includes PaperPort[®] for Brother and ScanSoft[™] TextBridge[®]. (See Chapter 17, *Using ScanSoft[™] PaperPort[®] for Brother/ TextBridge[®]*.)

Software by: **SMITHMICRO** 
SOFTWARE

Brother Resource Manager



The Brother Resource Manager application must be running for you to use your MFC with your Windows[®] computer. Multi-Function Link Pro software and the MFL Pro Printer Driver automatically load the Resource Manager, as needed. The Resource Manager allows the single bi-directional Parallel port on the MFC to simulate a Communications port for faxing and scanning and to simulate a Parallel port for Windows[®] GDI printing. The MFC also can use Epson LQ-510, LQ-850 and LQ-2550 printer emulation, which do not require the Resource Manager.

MFC Remote Setup

The MFC Remote Setup application allows you to quickly set up your MFC by taking advantage of the ease and speed of programming on your PC. When you access this application, the settings on your MFC will be downloaded automatically to your PC and displayed on your computer screen. If you change the settings, you can upload them directly to the MFC.

Select the MFC Remote Setup icon from the Multi-Function Link® Pro program group. The Remote Setup screen will appear:

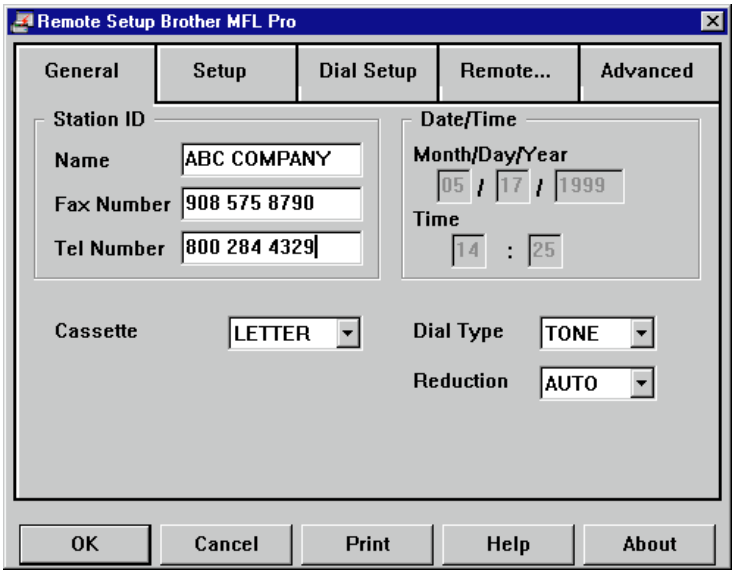

Multi-Function Link® Pro Main Menu

The Multi-Function Link® Pro Main Menu is the application used for all fax sending and receiving operations. It also contains an electronic Phone Book program and a Log Manager that maintains a record of all PC fax transactions. The Main Menu can be accessed through the Brother Multi-Function Link® Pro program group.

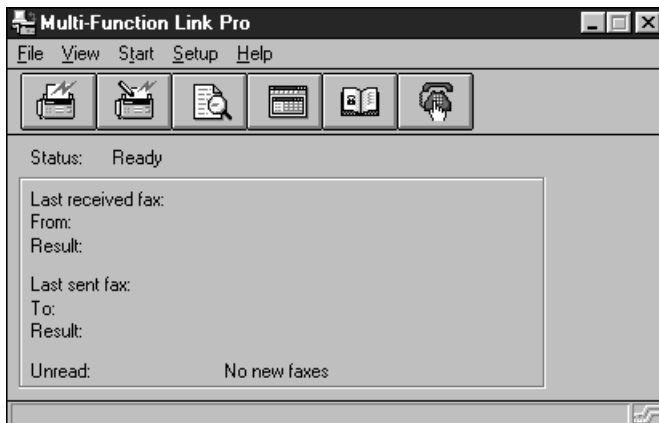

Sending a Fax from Your PC

Sending a Quick Fax

A QuickFax is a cover page only fax with a message. This option is very useful when you want to fax a quick, short message from your PC.

- 1 From the Main Menu, select the QuickFax  button—OR—Select QuickFax from the Start pull-down menu. The QuickFax screen will appear.
- 2 Enter the Fax number, Name, and Company information in the appropriate fields on the screen—OR—Select the Open Phone Book... button to choose someone from your phone book.
- 3 Complete the Subject and QuickFax note fields.
- 4 Click the Send Fax button.

Sending a Fax from the Main Menu

You can send a fax from the Main Menu and attach multiple files. The “attachments” can be in different file formats.

- 1 From the Main Menu window, select the Send Fax  button—OR—Select Send Fax from the Start pull-down menu. The Send Fax window will appear:

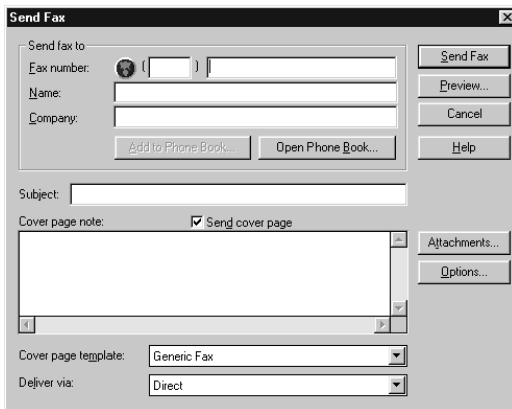

- 2 Enter the Fax number, Name, and Company information in these fields —OR—Select the Open Phone Book button to choose someone from your phone book.
- 3 Complete the Subject and Cover page note fields.
- 4 Click on the Attachments... button to add any file(s) you want to fax with it.
- 5 Click the Send Fax button.

Sending a Fax from a Windows® Application

You can send a fax directly from any Windows® application using the following steps:

- 1 Create the document in a Windows® application.
- 2 Select **Brother MFL Pro Fax** as your printer.
- 3 Select the Print command to begin the fax transmission. The Fax Sending dialog box will appear :
- 4 Enter the name and fax number of the recipient—OR—Select the Open Phone Book... button and choose a name. Select Close to return to the Send Fax dialog box.
- 5 Select the Send cover page check box to include a cover page.
- 6 Select the Send Fax button.

Receiving Faxes into the PC

To receive faxes into your PC through the MFC, first you must have connected your MFC to your computer. Then, you can load the Multi-Function Link[®] Pro software. (See *Setting up the MFC and PC to Work Together*, page 12-1.)

Use the following checklists for the MFC and PC, to make sure you have properly set up the MFC and PC to work together.

Checklist for the MFC

- 1 To make sure the MF Link mode is active, press **Function**, **1**, **2**, **0**.
 - 2 Use **←** or **→** to select ON (not OFF).
 - 3 Press **Set**.
-  Set MF Link mode to OFF *only if* you want all incoming faxes to be printed at the MFC.

Checklist for Your PC

- 1 Make sure the MFC is connected to the PC.
- 2 In the Main Menu, select the Setup pull-down menu.
- 3 Select Preferences...
- 4 Under Answer Mode, select Fax only.
- 5 Click the OK button.
- 6 Keep the PC and the Multi-Function Link[®] Pro Main Menu running at all times.

Viewing Received Faxes

Faxes that are received into the PC will appear in the InBox of the Log Manager. To access the Log Manager, from the Main Menu click the

Log Manager  button—OR—From the Start pull-down menu, select Mail/Log.

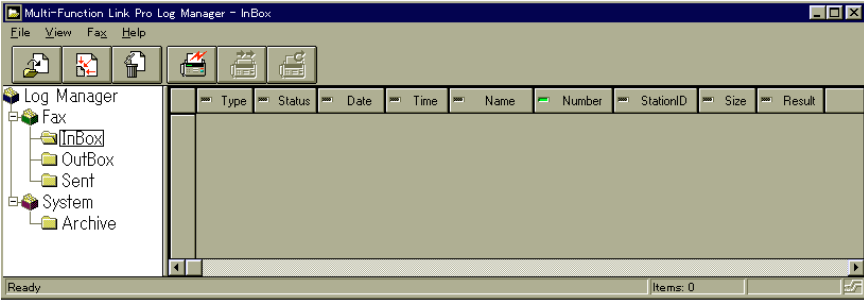

- 1 In the Log Manager, select the Fax folder.
- 2 Then select the InBox folder. A listing of your incoming messages will appear on the right side of the window.
- 3 Double-click on the fax you wish to view.

The ScanSoft™ PaperPort® Viewer will run automatically and the fax you selected from the list will be displayed. (See *Using ScanSoft™ PaperPort and ScanSoft™ TextBridge®*, page 17-1.)

17 Using ScanSoft™ PaperPort® for Brother/TextBridge®

Using the Scan Keys

You can use the Scan keys on the panel to control scan originals to your word processing, graphics or E-mail applications.

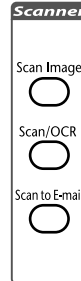

Using the Control Panel Keys (For Windows® 95/98 and Windows NT® 4.0 Only)

 If you have connected a Macintosh G3 or iMac, the control panel keys will *not* work with your PC. Please see *Using Brother TWAIN Scanner Driver with Your Apple® New Power Macintosh® G3 or iMac*, page 23-2.

 The control panel keys are *not* available for Windows® 3.1x.

Before you can use the Scan keys on the control panel, you must have connected the MFC to your Windows® based PC and loaded the appropriate Brother Drivers for your version of Windows®. When you are ready to use the Scan keys, make sure the Brother Control Center application is running on your PC. (For details about how to configure the Brother Control Center buttons to launch the application of your choice using the Scan keys, see Chapter 15, "Using the Windows® Based Brother Control Center.")

Scan Image

You can scan a color picture into your graphics application for viewing and editing.

- 1 Place your original in the ADF or on the scanner glass.
- 2 Press **Scan Image**.

The MFC will scan the original and send a color image to your graphics application.

SCANNING: IMAGE

Scan/OCR

If your original is text, you can have it automatically converted by ScanSoft™ TextBridge® to an editable text file and then displayed in your word processing application for further editing.

- 1 Place your original in the ADF or on the scanner glass.
- 2 Press **Scan/OCR**.
- 3 The MFC will scan the original perform OCR in ScanSoft™ TextBridge®, and then display the result in your word processing application for viewing and editing.

SCANNING:OCR

Scan to E-mail

You can scan *either* a black and white or a color original into your E-mail application as a file attachment. Although the Brother Control Center can be configured to send only black and white *or* color file attachments at one time, you can easily change this setting. (For details, see Chapter 15, *Using the Windows® Based Brother Control Center.*)

- 1 Place the original in the ADF or on the scanner glass.
- 2 Press **Scan to E-mail**.
- 3 The MFC will scan the original, create a file attachment, and launch your E-mail application, displaying the new message waiting to be addressed.

SCANNING:E-MAIL

Using ScanSoft™ PaperPort® and TextBridge®

ScanSoft™ PaperPort® for Brother is a document management application. You will use PaperPort® to view incoming faxes and scanned documents. PaperPort® has a sophisticated, yet easy-to-use, filing system that will help you organize your graphics and text documents. It allows you to combine or “stack” documents of different formats for printing, faxing or filing. ScanSoft™ PaperPort® can be accessed through the ScanSoft™ PaperPort® program group. See *On-Line Documentation for Multi-Function Link® Pro* on the CD-ROM.

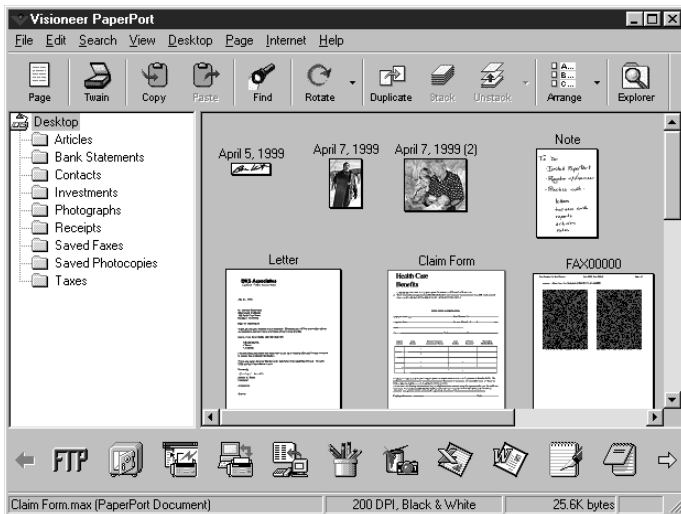

The complete ScanSoft™ PaperPort® Owner’s Manual, including ScanSoft™ TextBridge® OCR, is in the On-Line Documentation on the CD-ROM. This chapter is only an introduction to the basic operations.

Viewing Items in ScanSoft™ PaperPort®

ScanSoft™ PaperPort® provides several ways to view items: **Desktop View** displays a **thumbnail**, a small graphic that represents each item in a Desktop or folder. Items in the selected folder appear on the PaperPort® Desktop. You can see PaperPort® items (MAX files) and non-PaperPort® items (files created using other applications). Non-PaperPort® items include an icon that indicates the application that was used to create the item; a non-PaperPort® item is represented by a small rectangular thumbnail and not an actual image.

Page View displays a close-up of a single page and you can open a PaperPort® item by double-clicking on it. As long as you have the appropriate application on your computer to display it, you can also double-click a non-PaperPort® item to open it.

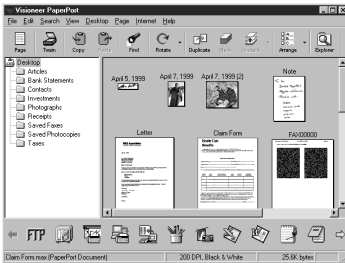

Desktop View displays items as thumbnails

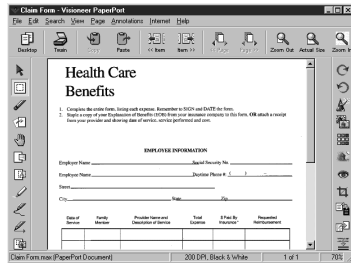

Page View displays each item as a full page

Organizing Your Items in Folders

PaperPort® has an easy-to-use filing system for organizing your items. The filing system consists of folders and items that you select to view in Desktop View. An item can be a PaperPort® item or a non-PaperPort® item:

- Folders are arranged in a “tree” structure in the Folder View. You use this pane to select folders and view their items in Desktop View.
- You can simply drag and drop an item onto a folder. When the folder is highlighted, release the mouse button and the item is stored in that folder.
- Folders can be “nested”—that is, stored in other folders.
- When you double-click a folder, its items (both PaperPort® MAX files and other files) appear on the Desktop.
- You can also use Windows® Explorer to manage the folders and items shown in Desktop View.

Links to Many Other Applications

ScanSoft™ PaperPort® automatically recognizes many other applications on your computer and creates a “working link” to them. The Link Bar at the bottom of Desktop view shows icons of those linked applications. To use a link, drag an item onto one of the icons to start the application represented by the icon. A typical use of the Link Bar is to select an item and then fax it.

This sample Link Bar shows several applications with links to PaperPort®.



If PaperPort® does not automatically recognize one of the applications on your computer, you can manually create a link using the **Create New Link** command. (See *PaperPort®* in the On-Line-Documentation on the CD-ROM for more information about creating new links.)

Using ScanSoft™ TextBridge® OCR (Converting Image Text to Text You Can Edit)



ScanSoft™ TextBridge® OCR is automatically installed when you install ScanSoft™ PaperPort® on your computer.

ScanSoft™ PaperPort® can quickly convert the text on a ScanSoft™ PaperPort® item (which is really just a picture of the text) into text that you can edit with a word processing application. PaperPort® uses the optical character recognition application ScanSoft™ TextBridge®, which comes with PaperPort®—**OR**—PaperPort® uses your application if it is already on your computer. You can convert the entire item, or by using the **Copy As Text** command, you can select only a portion of the text to convert.

Dragging an item onto a word-processing link icon starts PaperPort®’s built-in OCR application, or you can use your own OCR application.



Importing Items from Other Applications

In addition to scanning items, you can bring items into PaperPort® in a variety of ways and convert them to PaperPort® (MAX) files in several different ways:

- Print to the Desktop View from another application, such as Microsoft Excel.
- Import files saved in other file formats, such as Windows® Bitmap (BMP) or Tag Image File Format (TIFF).

Exporting Items in Other Formats

You can export or save PaperPort® items in several popular file formats, such as BMP, JPEG, TIFF, or self-viewing. For example, to create a file for an Internet Web site, export it as a JPEG file. Web pages often use JPEG files for displaying images.

Scanning a Document

TWAIN COMPLIANT

The Brother Multi-Function Link® Pro software includes a TWAIN compliant scanner driver. TWAIN drivers meet the standard universal protocol for communicating between scanners and software applications. This means that not only can you scan images directly into the PaperPort® viewer that Brother included with your MFC, but you can also scan images directly into hundreds of other software applications that support TWAIN scanning. These applications include popular programs like Adobe Photoshop, Adobe PageMaker, CorelDraw and many more.

To choose Brother Multi-Function Link® Pro as your scanner driver, select it under the Select scanner—**OR**—Select source option in your software.

Accessing the Scanner

From the PaperPort® window, select the **Scan** or **TWAIN** button or from the File drop-down menu choose Acquire. Multi-Function Link® Pro's TWAIN dialog box will appear:

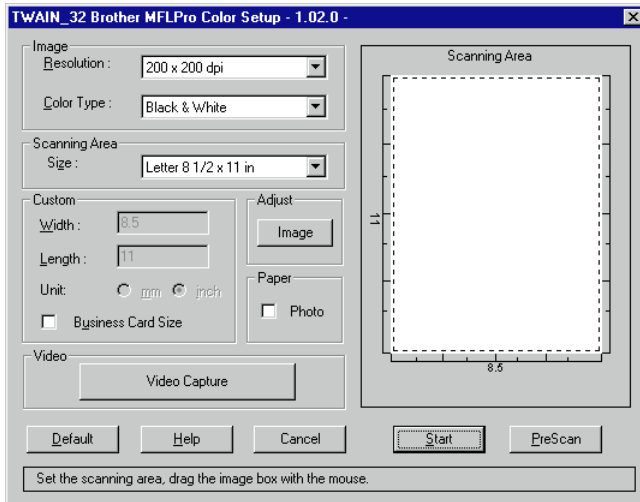

Scanning a Document into the PC

- 1 Place the original in the ADF or on the scanner glass.
- 2 Adjust the following settings, if needed, in the Scanner window:
 - Resolution
 - Color Type (Black & White, Gray [Error Diffusion], True Gray, 256 Color, 24 bit color or 24 bit color [Fast])
 - Size
- 3 Select the **Start** button from the scanner window.

When scanning is completed, press Cancel to return to the PaperPort® window.

Settings in the Scanner Window

Resolution:

Resolution: Select the scanning resolution from the Resolution drop down list. Higher resolutions take more memory and transfer time, but can achieve a finer scanned image. You can choose:

- 100 x 100 dpi
- 150 x 150 dpi
- 200 x 100 dpi (Black & White, Gray [Error Diffusion] only)
- 200 x 200 dpi
- 200 x 400 dpi (Black & White, Gray [Error Diffusion] only)
- 300 x 300 dpi
- 400 x 400 dpi
- 600 x 600 dpi
- 1200 x 1200 dpi (Black & white, Gray [Error Diffusion]. True Gray, 24 bit color and 24 bit color [Fast] only)

Color Type:

Black & White: Set the Color Type to Black & White for text or line art.

Gray Scale: For photographic images, set the Color Type to Gray (Error Diffusion) or True Gray.

Colors: Choose either 256 Color, which scans up to 256 colors, 24 bit color 24 bit color [Fast], which scans up to 16.8 million colors. Although using 24 bit color or 24 bit color [Fast] creates an image with the most accurate colors, the image file will be approximately nine times larger than a file created with 256 Color. You have a choice of faster scanning with 24 bit color [Fast] or using the Brother Color Matching Technology with 24 bit color.

Size:

Set the Size to one of the following:

- Letter (8 1/2 x 11 in.)
- A4 (210 x 297 mm.)
- Legal (8 1/2 x 14 in.)
- A5 (148 x 210 mm.)
- B5 (182 x 257 mm.)
- Executive (7 1/4 x 10 1/2 in.)
- Business Card (90 x 60 mm.)
- Custom (User adjustable from 0.35 x 0.35 in. to 8.5 x 14 in.)

After you select a custom size, you can adjust the scanning area further by using the left mouse button to drag the dotted outline of the scanning area. This is required when you want to crop an image when scanning.

To scan business cards, select the Business Card (90 x 60 mm.) size setting and place the business card at the top center of a carrier sheet.

Carrier sheets are available from your Dealer.

When scanning photographs or other images for use in a word processor or other graphics application, you should try different settings for the contrast, mode and resolution to see which settings best suit your needs.

Custom:

This section displays the size you selected. To adjust the scanning area size to business card size automatically, check the Business Card Size box.

Adjust:

In the Adjust section, click the **Image** button. The Image screen will appear:

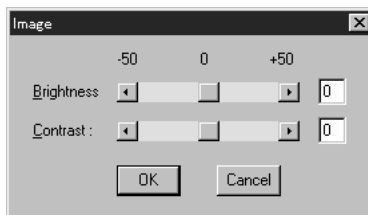

Use the cursor to drag the indicator buttons to the left or right to adjust the Brightness and the Contrast, as needed.

Paper:

Check the Photo box if the image is a photograph.

Video Capture:

The Video Capture button displays the video frame grabber window. (See *Video Capture from the PC*, page 17-12 for details.)

PreScanning an Image

PreScanning allows you to scan an image quickly at a low resolution. A thumbnail version of the image will appear in the Scanning Area. This is only a preview of the image so you can see how it will look. The PreScan button is used to preview an image for cropping any unwanted portions from the image. When you are satisfied with the preview, select the **Start** button from the scanner window to scan the image.

How to use PreScan to adjust an image:

- 1 Insert the original face down in the ADF of your MFC.
- 2 Select the **PreScan** button.

The entire original will be scanned into the PC and will appear in the Scanning Area of the Scanner window.

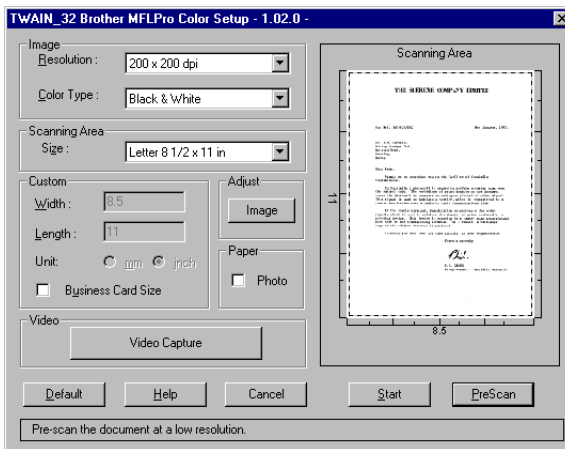

- 3 To crop a portion of the original to be scanned, drag any side or corner of the dotted outline in the Scanning Area with the left mouse button. Adjust the dotted outline until it surrounds only the portion of the original you wish to scan.
- 4 Place the original in the ADF or on the scanner glass again.
- 5 Adjust the settings for Resolution, Color Type and Size in the Scanner window, as needed.

- 6 Select the **Start** button.

This time only the selected area of the original will appear in the PaperPort® window.

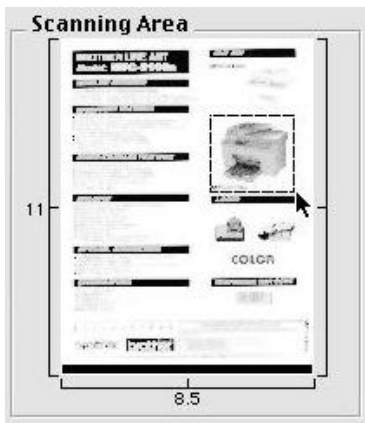

- 7 In the PaperPort® window, use the options available to refine the image. (See PaperPort® for Brother Online Documentation on the CD-ROM for details.)

Video Capture from the PC

Video Capture is the process of isolating a single frame (or picture) from media played on video equipment (such as a video camera or VCR) and then converting that frame into an image file on your PC. Once the frame is an image file, it can be saved, printed, faxed, and inserted into other files.

Connecting Your Video Equipment

Before you can begin to capture a video frame, you must first connect your video equipment to the MFC.

To connect your video equipment:

- 1 Connect your video cable to the jack on your video equipment labeled **VIDEO OUT**.
- 2 Connect the RCA male plug on the other end of the video cable to the RCA female jack on the front of the MFC.

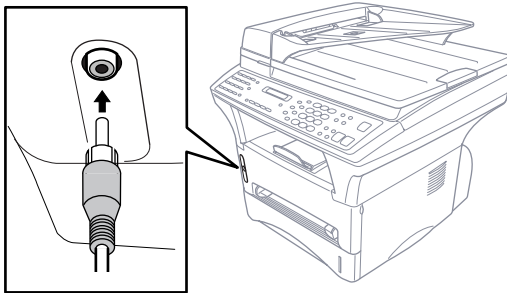

Capturing An Image

You can access Multi-Function Link® Pro's TWAIN dialog box from the ScanSoft™ PaperPort® for Brother viewer or from any application that is compatible with TWAIN scanning devices.

To capture a frame as an image:

- 1 Connect your video equipment to the MFC.
- 2 From PaperPort®, select **Acquire** from the **File** menu, or click on the Scan (TWAIN)  icon.

Multi-Function Link® Pro's TWAIN dialog box will appear:

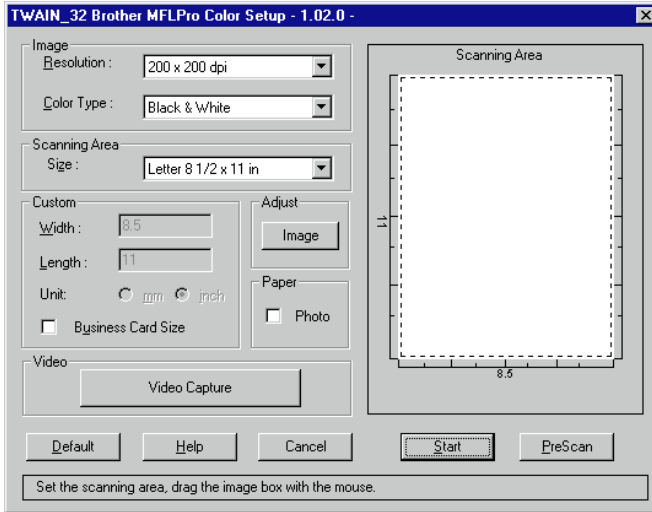

- 3 In the Multi-Function Link® Pro Setup (TWAIN) dialog box, click the **Video Capture** button.

The Video Capture dialog box will appear.



- 5 Select the **Source** of the video:
 - Live Camera
 - Tape/VCR
 - Laser Disc®
 - Digital Camera
- 6 Select the **Type** of video:
 - Auto-is the most common choice, since the system will determine the Type for you.
 - Moving
 - Still
 - High Quality
 - Pro Quality-is the highest quality.
- 7 Select the **Preview** type:
 - B & W-Black and White displays approximately four frames per second.
 - Color-displays approximately one frame every two seconds because color images contain much more data.
- 8 Select the **Size** (dots per inch) of the image file to be created:
 - 1280 x 960-is the best quality. The image file will be large and take more space on your PC.
 - 750 x 562
 - 640 x 480-is suitable for most images.
 - 320 x 240
- 9 Turn on your video equipment and start running the video.
- 10 When you see the frame you want to capture, click the **Pause** button. The frame will be displayed in the viewer screen section of Multi-Function Link® Pro's TWAIN dialog box.
- 11 If you wish to capture the displayed frame, click the **OK** button –**OR**–
If you are not satisfied with the frame that is displayed, resume running the video by clicking the **Pause** button a second time.
The video will resume running.
- 12 Click the **Quit** button to exit the Video Capture dialog box.
- 13 Run PaperPort®, where a thumbnail image of your frame will be displayed. (See ScanSoft™ PaperPort® Online Documentation on the CD-ROM for details).

18 Using Internet Faxing with NetCentric™ FaxStorm

Internet Faxing **(For Windows® 3.1 / 95/98 /NT® 4.0 Only)**

Internet faxing (**NetCentric FaxStorm**) brings together the power of the PC and the economy of the Internet. Outgoing faxes are relayed from your desktop to a network provider's fax server over an IP connection. From the server, the fax job is transmitted across the Internet using sophisticated least-cost-routing algorithms, then delivered to a fax machine using local phone lines, or to another computer as an E-mail attachment. Faxes can be sent to a single recipient or to multiple recipients. NetCentric™ FaxStorm tracks your faxes to their destinations, and informs you of their status. When servers are down due to Internet outages, NetCentric™ FaxStorm re-routes your fax jobs and requests for account status.

You can access incoming faxes from any web-connected desktop and even forward them to others directly from the Inbox account.

Before You Use this Software

Please read "Using Internet Faxing with NetCentric™ FaxStorm" in the **On-Line Documentation** on the CD-ROM (and in the Brother fax-back system) and check the online README.WRI file in the root directory of the CD-ROM for last-minute important information and troubleshooting tips not included in the On-Line Documentation.

For more detailed instructions about how to use NetCentric™ FaxStorm, see the online HELP files after you install NetCentric™ FaxStorm on your computer. Use the *Help* pull-down menus to access HELP.

To Look for Software Updates at www.brother.com

- 1 Select your country and click **Go!!**
- 2 Under *Facsimile / Multi-Function / Phone System* banner, click **Software**.
- 3 Click **Windows 3.1 / 95 / 98 / NT 4.0**.
- 4 Select the application or product category you want.

To Access the On-Line Documentation

After you have installed the Brother driver(s) for your model and operating system, click **View On-Line Documentation** for operation instructions.

Customer Support

You can select *Web Problem Reports* from the *Utilities* menu of the NetCentric™ FaxStorm window. Your web browser will open the problem report page of NetCentric Corporation. Use this to send your problem directly to Customer Support at NetCentric Corporation, or

Contact NetCentric Corporation at

28 Crosby Drive
Bedford, MA, USA 01730

1 (781) 685-5200 (voice)

9 a.m. to 6 p.m., EST,
Monday through Friday

1 (781) 685-5600 (fax)

E-mail: support@netcentric.com

24 hours a day
7 days a week

19 Using Automatic E-Mail Printing

For Windows® 95/98 Only

Main Features

- You can use Automatic E-Mail Printing with other E-mail software: Brother Automatic E-Mail Printing has some extra functions that other E-mail software, such as Netscape Navigator™ or MS Internet Mail, do not support.
- Automatic E-Mail Printing can be configured for a multiple user account: In Brother Automatic E-Mail Printing you can set more than one e-mail account on a single PC so you can print e-mail in each account automatically.
- Automatic access to your specified POP3 server at the specified time: You can specify the time when the Brother Automatic E-Mail Printing automatically accesses the server to check for new mail.
- Provides an “In Memory” printer driver: You can receive and print e-mail data at the same time, by searching for a specified character string in the mail header. It allows you to see the sender, subject and relevant part of the mail content.

Before You Use this Software

Please read “Using Automatic E-Mail Printing” in the **On-Line Documentation** on the CD-ROM (and in the Brother fax-back system) and check the online README.WRI file in the root directory of CD-ROM 1 for last-minute important information and troubleshooting tips not included in the On-Line Documentation. Look for updates at www.brother.com, which will be listed under your model number. (See page 19-2)

To Look for Software Updates at www.brother.com

- 1 Select your country and click **Go!!**
- 2 Under *Facsimile / Multi-Function / Phone System* banner, click **Software**.
- 3 Click **Windows 3.1 / 95 / 98 / NT 4.0**.
- 4 Select the application or product category you want.

To Access the On-Line Documentation

After you have installed the Brother driver(s) for your model and operating system, click **View On-Line Documentation** for operation instructions.

20 Optional Accessories

Additional Memory for Faxing/Printing

The memory board is installed on the main controller board inside the Brother machine. When you add the optional memory board, it increases the performance modes for both fax and printer operations.

The MFC has 8 MB of memory. All models can recognize 8 MB (**ME8000**) or 16 MB (**ME16000**) of Optional Memory. Be careful to purchase the appropriate memory board for your needs.

For the Printer

Additional memory is useful and may be necessary if you want to download many different fonts or want to print a very complex document.

For the Fax

Additional memory is available and will expand the memory used for sending and receiving faxes.

	Optional Memory	Total
7 MB (up to 700 pages)	8 MB or 16 MB	15 MB (up to 1500 pages) or 23 MB (up to 2300 pages)

Using Brother #1 Chart with JBIG coding and Standard Resolution.

Paper Cassette #2 (Option)

You can purchase the Paper Cassette #2 accessory (**LT400**) to use as a third paper source. Cassette #2 holds up to 250 sheets of 20 lb. (75 g/m²) paper.

Multi-purpose Paper Cassette #2:	Holds approx. 250 sheets of 20 lb. (75 g/m ²) or 50 sheets of 42 lb. (158 g/m ²) Letter/A4 paper, 10 transparencies
Basis Weight:	17 to 28 lb. (64 to 105 g/m ²)
Caliper:	0.003 to 0.005 inches. (0.08 to 0.13 mm)
Moisture Content:	4% to 6% by weight
Smoothness:	100 to 250 (Sheffield)
We Recommend:	
Cut sheet:	Xerox 4200
Label:	Avery laser label or equivalent
Transparency:	3M CG3300 for laser printers or equivalent

Network (LAN) Board

When you add the Network (LAN) Board (NC-8000), you can connect your MFC into the network and use Internet FAX, FAX Gateway, Network Scanner, Network Printer and Network Management functions.

21 Important Information

Standard Telephone and FCC Notices (For 120V Models Only)

These notices are in effect on models sold and used in the United States only.

When programming emergency numbers and/or making test calls to emergency numbers:

- Remain on the line and briefly explain to the dispatcher the reason for the call before hanging up.
- Perform these activities in the off-peak hours, such as early morning or late evening.

This equipment complies with Part 68 of FCC Rules. On the rear panel of this equipment is a label that contains, among other information, the FCC Registration Number and Ringer Equivalence Number (REN) for this equipment. You must, upon request, provide this information to your telephone company.

You may safely connect this equipment to the telephone line by means of a standard modular jack, USOC RJ11C.

An FCC compliant telephone cord with a modular plug is provided with this equipment. This equipment is designed to be connected to the telephone line or premise's wiring using a compatible modular jack that is Part 68 compliant. See the Installation section of this manual for details.

The REN is useful in determining the quantity of devices you may connect to your telephone line and still have those devices ring when your telephone number is called. In most, but not all areas, the sum of the RENs of all devices connected to one line should not exceed five (5). To be certain of the number of devices you may connect to your line, as determined by the REN, you should contact your local telephone company to determine the maximum REN for your calling area. If your machine damages the telephone line, the telephone company may discontinue your service temporarily. If possible, they will notify you in advance. If advanced notice is not practical, you will be notified as soon as possible. You will be informed of your right to file a complaint with the FCC.

Your telephone company may make changes to its facilities, equipment, operations or procedures that could affect the proper functioning of your equipment. If they do, you will be notified in advance to give you an opportunity to maintain uninterrupted telephone service.

If you experience trouble with your machine, please contact a Brother Authorized Service Center for information on service or repair. The telephone company may ask that you disconnect this equipment from the line until the problem has been corrected or until you are sure that the equipment is not malfunctioning.

If you are not able to solve a problem with your multi-function center, contact Brother Customer Service at

USA:	1-800-284-4329	(voice)
	1-908-575-8790	(fax)
From within Canada:	1-800-853-6660	(voice)
	1-514-685-4898	(fax)
From within Montreal:	1-514-685-6464	(voice)

WARNING

To protect against risk of electrical shock, always disconnect all cables from wall outlets before servicing, modifying or installing the equipment.

Use of controls, adjustments or performance of procedures other than those specified in this manual may result in hazardous invisible radiation exposure.

This equipment may not be used on coin service lines provided by the telephone company or connected to party lines.

Federal Communications Commission (FCC) Declaration of Conformity (For USA Only)

Responsible Party : Brother International Corporation
100 Somerset Corporate Boulevard
Bridgewater, NJ 08807-0911 USA
TEL : (908) 704-1700

declares, that the products

Product Name : MFC 9600

comply with Part 15 of the FCC Rules. Operation is subject to the following two conditions: (1) This device may not cause harmful interference, and (2) this device must accept any interference received, including interference that may cause undesired operation.

ENERGY STAR® Compliance Statement

As an ENERGY STAR® Partner, Brother Industries, Ltd. has determined that this product meets the ENERGY STAR® guidelines for energy efficiency.



Important—About the Interface Cable

A shielded interface cable which is included with your machine should be used to ensure compliance with the limits for a Class B digital device.



Caution

Changes or modifications not expressly approved by Brother Industries, Ltd. could void the user's authority to operate the equipment.

Industry Canada Compliance Statement (For Canada Only)

This Class B digital apparatus complies with Canadian ICES-003.

Cet appareil numérique de la classe B est conforme à la norme NMB-003 du Canada.

Laser Safety (For 110-120V Models Only)

This equipment is certified as a Class I laser product under the U.S. Department of Health and Human Services (DHHS) Radiation Performance Standard according to the Radiation Control for Health and Safety Act of 1968. This means that the equipment does not produce hazardous laser radiation.

Since radiation emitted inside the equipment is completely confined within protective housings and external covers, the laser beam cannot escape from the machine during any phase of user operation.

FDA Regulations

U.S. Food and Drug Administration (FDA) has implemented regulations for laser products manufactured on and after August 2, 1976. Compliance is mandatory for products marketed in the United States. The following label on the back of the machine indicates compliance with the FDA regulations and must be attached to laser products marketed in the United States.

Manufacturing Information

<p>BROTHER CORP. (ASIA) LTD. BROTHER BUJI NAN LING FACTORY Gold Garden Industry, Nan Ling Village, Buji, Rong Gang, Shenzhen, China. This product complies with FDA radiation performance standards, 21 CFR Subchapter J.</p>

Important Safety Instructions

- 1** Read all of these instructions.
- 2** Save them for later reference.
- 3** Follow all warnings and instructions marked on the product.
- 4** Unplug this product from the wall outlet before cleaning. Do not use liquid or aerosol cleaners. Use a damp cloth for cleaning.
- 5** Do not place this product on an unstable cart, stand, or table. The product may fall, causing serious damage to the product.
- 6** Slots and openings in the cabinet and the back or bottom are provided for ventilation. To ensure reliable operation of the product and to protect it from overheating, these openings must not be blocked or covered. The openings should never be blocked by placing the product on a bed, sofa, rug, or other similar surface; near or over a radiator or heater; or in a built-in wall unit or cabinet without ventilation.
- 7** This product should be operated from the type of power source indicated on the label. If you are not sure of the type of power available, consult your dealer or local power company.
- 8** Use only the power cord supplied with this machine.
- 9** This product is equipped with a 3-wire grounding type plug, a plug having a third (grounding) pin. This plug will fit into only a grounding-type power outlet. This is a safety feature. If you are unable to insert the plug into the outlet, contact your electrician to replace your obsolete outlet. Do not defeat the purpose of the grounding-type plug, by using an adapter.
- 10** Do not allow anything to rest on the power cord. Do not place this product where people can walk on the cord.
- 11** If an extension cord is used with this product, make sure that the total ampere ratings on the products plugged into the extension cord do not exceed the extension cord ampere rating. The total of all products plugged into the wall outlet must not exceed 15 amperes (USA only).
- 12** Never push objects of any kind into this product through cabinet slots, since they may touch dangerous voltage points or short out parts resulting in the risk of fire or electric shock. Never spill liquid of any kind on the product.
- 13** This product has no ON/OFF switch. In case the main power to the machine must be disconnected quickly, it is very important that you have easy access to the main plug and the main socket where the plug is connected.

- 14** Unplug this product from the wall outlet and refer servicing to a Brother Authorized Service Center under the following conditions:
- A** When the power cord is damaged or frayed.
 - B** If liquid has been spilled into the product.
 - C** If the product has been exposed to rain or water.
 - D** If the product does not operate normally when the operating instructions are followed. Adjust only those controls that are covered by the operating instructions. Improper adjustment of other controls may result in damage and will often require extensive work by a qualified technician to restore the product to normal operation.
 - E** If the product has been dropped or the cabinet has been damaged.
 - F** If the product exhibits a distinct change in performance, indicating a need for service.

- 15** Do not attempt to service this product yourself, as opening or removing covers may expose you to dangerous voltage points and/or other risks, and may void your warranty. Refer all servicing to a Brother Authorized Service Center. A list of Brother Authorized Service Centers has been included for your convenience, or you may contact the following Brother Customer Service numbers for your nearest Brother Authorized Service Center:

USA: 1-800-284-4329 (voice)
1-908-575-8790 (fax)
1-800-521-2846 (fax-back system)

From within Canada: 1-800-853-6660 (voice)
1-514-685-4898 (fax)
1-800-681-9838 (fax-back system)

From within Montreal: 1-514-685-6464 (voice)

- 16** To protect your product against power surges, we recommend the use of a power protection device (Surge Protector).

- 17** When using your telephone equipment, basic safety precautions should always be followed to reduce the risk of fire, electric shock and injury to persons, including the following:
- Do not use this product near appliances that use water, a swimming pool or in a wet basement.
 - Do not use the machine's telephone during an electrical storm (there is the remote possibility of an electrical shock) or to report a gas leak in the vicinity of the leak.
 - Use only the power cord indicated in this manual.

Compilation and Publication Notice

Under the supervision of Brother Industries Ltd., this manual has been compiled and published, covering the latest product descriptions and specifications.

The contents of this manual and the specifications of this product are subject to change without notice.

Brother reserves the right to make changes without notice in the specifications and materials contained herein and shall not be responsible for any damages (including consequential) caused by reliance on the materials presented, including but not limited to typographical and other errors relating to the publication.

Trademarks

Brother is a registered trademark of Brother Industries, Ltd.

The brother logo is a registered trademark of Brother Industries, Ltd.

Multi-Function Link Pro is a registered trademark of Brother Industries, Ltd.

© Copyright 1996–2000 Brother Industries, Ltd. All rights reserved.

© Copyright 1996–2000 Smith Micro Software, Inc. All rights reserved.

© Copyright 1996–2000 ScanSoft. All rights reserved.

TextBridge and PaperPort are registered trademarks of ScanSoft, Inc.

Windows, Microsoft, MS-DOS, Excel and Word are registered trademarks of Microsoft in the U.S. and other countries.

NetCentric and FaxStorm are registered trademarks of NetCentric Corporation.

TrueType is a trademark of Apple Computer, Inc.

Centronics is a trademark of Genicom Corporation.

Epson is a registered trademark and FX-80 and FX-850 are trademarks of Seiko Epson Corporation.

Hewlett Packard is a registered trademark and HP LaserJet II, IIP, and IID are trademarks of Hewlett-Packard Company.

IBM, IBM PC, and Proprinter are registered trademarks of International Business Machines Corporation.

Hammermill copyplus white is a registered trademark of International Paper.

All other terms and brand and product names mentioned in this manual are registered trademarks of their respective companies.

22 Troubleshooting and Routine Maintenance

Troubleshooting

Brother fax-back system

Brother Customer Service has installed an easy-to-use fax-back system, so you can get instant answers to common technical questions and product information for all Brother products. This system is available 24 hours a day, 7 days a week. You can use the system to send faxes to any fax machine, not just the one from which you are calling.

If you can't resolve a difficulty with your machine using this manual, call our fax-back system, and follow the voice prompts to receive faxed instructions about using the system, and an index of fax-back subjects.

USA: 1-800-521-2846

From within Canada: 1-800-681-9838

The Brother fax-back system number (USA only) has been preprogrammed on One Touch key .

Frequently Asked Questions (FAQs)

You can find more information about Brother products on the World Wide Web, from product specification sheets to Frequently Asked Questions (FAQs), it is all there. Visit us at:

<http://www.brother.com>

Brother Bulletin Board

Brother's Bulletin Board Numbers are

USA: 1-888-298-3616

From within Canada: 1-514-685-2040

Error Messages

As with any sophisticated office product, errors may sometimes occur. If this happens, your MFC often identifies the problem and displays an error message. The table below explains the most common error messages.

You can correct most problems by yourself. If you need additional help, call the Brother fax-back system.

USA: 1-800-521-2846

From within Canada: 1-800-681-9838

Error Messages		
Error Message	Cause	Action
CHANGE DRUM SOON	The drum unit is near the end of its life.	Use the drum unit until you have a print quality problem; then replace the drum unit with a new one.
	The drum counter was not reset.	1. Open the front cover and press Clear . 2. Press 1 to reset.
CHECK PAPER CHECK PAPER #1 CHECK PAPER #2	The machine is out of paper or paper is not properly loaded in the paper cassette.	Refill the paper or remove the paper and load it again.
CHECK CASSETTE	MFC cassette cover is open or MFC cassette is not installed properly.	Close cassette cover or install cassette properly.
CHECK SCAN LOCK	The scanner lock is locked.	Release the scanner lock lever and press Stop . If you see MACHINE ERROR AF (or AE), stop operation and call Customer Service for assistance: USA: 1-800-284-4329 From within Canada: 1-800-853-6660 From within Montreal: 1-514-685-6464
COMM. ERROR	Poor phone line quality caused communication error.	Try the call again. If problem continues, call Telephone Company to check your phone line.
CONNECTION FAIL	You tried to poll a fax machine that is not in Polled Waiting mode.	Verify the other party's polling setup.
COOLING DOWN	The temperature of the drum unit or toner cartridge is too hot. The machine will pause its current print job and go into cooling down mode. During the cooling down mode, you will hear the cooling fan running while the display on the machine shows COOLING DOWN.	You must wait 20 minutes for it to cool.
COVER OPEN	The front cover was not completely closed.	Close the front cover for the drum unit.
DISCONNECTED	The other party or other party's fax machine terminated the call.	Try to transmit or receive again.

Error Messages		
Error Message	Cause	Action
DOCUMENT JAM	Documents were not inserted or fed properly, or document scanned from ADF was longer than about 40 inches (90cm).	See “Document Jams and Paper Jams”, page 22-4.
DOWNLOAD FULL	The download buffer is full.	Press [FF/Cont] . Printing will resume (the downloading is canceled).
MACHINE ERROR XX	MFC has a mechanical problem.	Call Brother Customer Service. USA: 1-800-284-4329 From within Canada: 1-800-853-6660 From within Montreal: 1-514-685-6464
MEMORY FULL	You can't store data in the memory.	See page 10-3.
NO RESPONSE/BUSY	The number you dialed does not answer or is busy.	Verify the number and try again.
NOT REGISTERED	You tried to access a One Touch or Speed Dial number that is not programmed.	Set up the One Touch or Speed Dial number. (See pages 7-1, 7-2.)
PLS CLEAN DRUM	The primary corona wire of drum unit is dirty.	Clean the primary corona wire of drum unit. (See page 22-22.)
PLS OPEN COVER	A page, piece of paper or paper clip, etc. may be jammed inside the MFC.	Open the front cover. If you see any jammed paper or other item, gently pull it out, then close the front cover. If the error message remains, open and close the front cover again. If the MFC cannot reset itself and return to the date and time prompt, it will display MACHINE ERROR XX. Please call Brother Customer Service and tell them the Machine Error number, at: USA: 1-800-284-4329 From within Canada: 1-800-853-6660 From within Montreal: 1-514-685-6464
PRINTER JAM	The paper is jammed in the MFC.	See page 22-5.

Error Messages		
Error Message	Cause	Action
TONER EMPTY	Toner cartridge is not installed. —OR— Toner is used up and printing is not possible.	Reinstall the toner cartridge. —OR— Replace the toner cartridge with a new one. (See page 22-19.)
TONER LOW	If the display shows TONER LOW and the Toner Empty LED on the control panel is blinking, you can still print. But the toner is depleted and the machine is telling you that the toner will soon run out.	Order a new toner cartridge now.
WARMING UP	The print head detects low temperature.	Wait until the MFC warms up.

Document Jams and Paper Jams

Based upon where the original document or printed sheet is jammed, follow the appropriate set of instructions to remove it.

Document Jam in the Top of the ADF Unit

- 1 Remove any paper from the ADF that is not jammed.

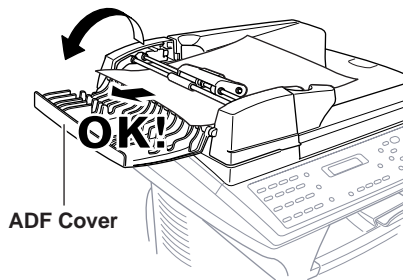

- 2 Lift the ADF cover.
- 3 Pull the jammed document out to the left.
- 4 Close the ADF cover.
- 5 Press .

Document Jam Inside the ADF Unit

- 1 Open the document cover.
- 2 Remove any paper from the ADF that is not jammed.

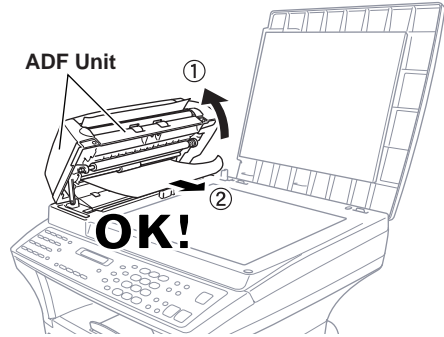

- 3 Lift the ADF unit.
- 4 Pull the jammed original out to the right.
- 5 Close the ADF unit.
- 6 Press **Stop**.

Printer Jam

Before you can clear a printer jam error, you must find out where the paper is stuck. See the following three types of paper jams.

WARNING

Do not use force to pull the jammed paper from the paper tray because you may damage the machine and cause toner to scatter on the next printed pages.

After you use the machine, some internal parts are extremely **HOT!** When you open the front, never touch the shaded parts shown in the following diagram.

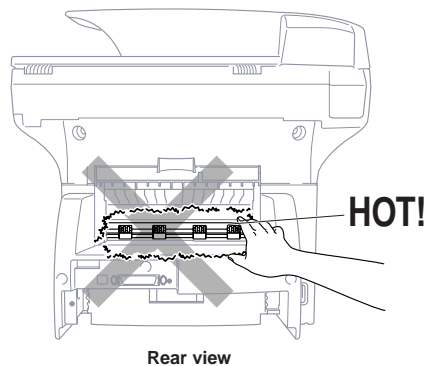
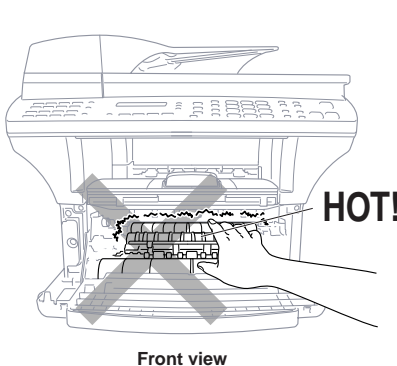

Paper is Jammed in the Multi-purpose Paper Cassette

- 1 Pull the paper cassette out of the machine.
- 2 Remove any crinkled sheets.

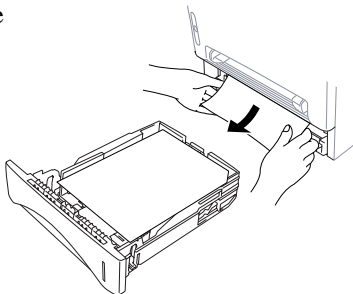

- 3 Adjust the guides to fit.
- 4 Press down the paper to flatten it in the paper cassette.
- 5 Reinstall the paper cassette.

Paper is Jammed near the Drum Unit

- 1 Open the front cover.
- 2 Remove the drum unit but do not force it if it cannot be removed easily. Instead, pull the edge of the jammed paper from the paper cassette.

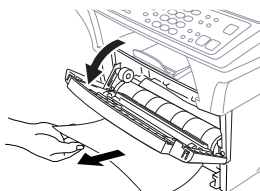
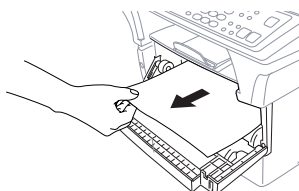

- 3 Gently pull out the jammed paper.
- 4 Reinstall the drum unit.
- 5 Close the front cover.

Paper is Jammed in the Fuser Unit

- 1 Open the rear cover.
- 2 Pull out jammed paper. When you have to pull paper out the back of the machine, the fuser may get dirty with toner powder causing the next few printed page(s) to look messy. Print a few copies of the test page until the pages print clearly.
- 3 Close the rear cover.

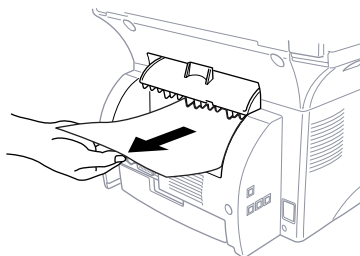

If You Are Having Difficulty with Your MFC

If you think there is a problem with your MFC, *make a copy first*. If the copy looks good, the problem is probably not your MFC. Check the chart below and follow the troubleshooting tips.

	Difficulty	Suggestions
▶ Printing or Receiving Faxes	Condensed Print and Horizontal Streaks / Top and Bottom of Sentences Are Cut Off.	If your copy looks good, you probably had a bad connection, with static or interference on the phone line. If the copy looks bad, call Brother Customer Service at 1-800-284-4329 (USA), 1-800-853-6660 (from within Canada) or 1-514-685-6464 (from within Montreal).
	Vertical Black Lines When Receiving	Sometimes you may see vertical streaks/black lines on the faxes you receive. Either your machine's primary corona wire for printing may be dirty, or the sending party's fax scanner may be dirty. Clean your primary corona wire (see page 22-19), or ask the sender to make a copy to see if the problem is with the sending machine. Try receiving from another fax machine. If the problem continues, call Brother Customer Service at 1-800-284-4329 (USA), 1-800-853-6660 (from within Canada) or 1-514-685-6464 (from within Montreal).
▶ Phone Line or Connections	MFC Does Not Answer When Called.	Make sure the MFC is not in MANUAL mode. Check for dial tone. If possible, call your MFC to hear it answer. If there is still no answer, check the telephone line cord connection. If there is no ringing when you call your MFC, call your Telephone Company to check the line.
▶ Sending Faxes	Poor Transmitting Quality	Try changing your resolution to FINE or SUPERFINE. Make a copy to verify your MFC's scanner operation.
	Transmission Verification Report says "Result:NG"	There is probably temporary noise or static on the line. Try sending the fax again. If the problem continues, call the Telephone Company to check your phone line.
	Vertical Black Lines When Sending	If the copy you made shows the same problem, your scanner is dirty. (See <i>Cleaning the Scanner</i> page 22-17.)
▶ Handling Incoming Calls	Transferring a Fax Call to the MFC.	If you answered at an external or extension phone, press your Fax Receive Code (default setting is *51). When your MFC answers, hang up.

Difficulty	Suggestions
Custom Features on a Single Line	<p>If you have Voice Mail, Distinctive Ring, an alarm system or any other custom feature on a single line with your MFC, it may create a problem sending or receiving fax data.</p> <p>For example: If you are sending or receiving a fax message while a custom feature signal comes through on the line, the signal can temporarily interrupt or disrupt the fax data. Brother's ECM feature should help overcome this problem. This condition is related to the telephone system industry, and is common to all devices that send and receive information on a single, shared line with custom features. If avoiding a slight interruption is crucial to your business, a separate line with no custom features is recommended.</p>
<p>► Copy Quality Difficulties</p> <p>Vertical streaks appear in copies.</p>	<p>Sometimes you may see vertical streaks on your copies. Either the scanner or the primary corona wire for printing is dirty. Clean them both. (See pages 22-17 and 22-19.)</p>
<p>► General Printing Difficulties</p> <p>The machine does not print.</p>	<p>Check the following:</p> <ul style="list-style-type: none"> • The machine is plugged in. (See page 2-8.) • The toner cartridge and drum unit are installed properly. (See page 2-4.) • The interface cable is securely connected between the machine and computer. (See page 12-2 to 12-3 or 12-10.) • Check to see if LCD is showing an error message. (See page 22-2.)
<p>The machine prints unexpectedly or it prints garbage.</p>	<p>Reset the machine or unplug the electrical cord and plug it back in. Check the primary settings in your application software to make sure it is set up to work with your machine.</p>
<p>The machine cannot print full pages of a document.</p>	<p>The machine received a very complex print job and could not process part of the page. This print may be solved in several ways. If you are using Windows® 3.1x, Windows® 95/98 or Windows NT® Workstation Version 4.0 with the supplied printer driver, see the "Windows® Setup Printing Problems" section. Try to reduce the complexity of your document or reduce print resolution.</p>
<p>The machine prints first couple of pages correctly, then some pages have text missing.</p>	<p>Your computer is not recognizing the printer's input buffer full signal. Please make sure to connect the printer cable correctly.</p>





Difficulty	Suggestions
<p>The machine cannot print full pages of a document. A MEMORY FULL message occurs.</p>	<ul style="list-style-type: none"> • Reduce the printer resolution. Reduce the complexity of your document and try again. Reduce the graphic quality or the number of font sizes within your application software. • Expand the printer memory by installing one of the optional memory boards (ME8000 or ME16000).
<p>My headers or footers appear when I view my document on the screen but do not show up when I print them.</p>	<p>Most laser printers have a restricted area that will not accept print. Usually these are the first two lines and last two lines, leaves 62 printable lines. Adjust the but do not show up when show top and bottom margins in your document to allow for this.</p>
<p>► Scanning Difficulties</p>	<p>TWAIN Errors appear while scanning.</p> <p>Make sure the Brother TWAIN Driver is selected as the primary source. In PaperPort®, click File Select Source, highlight the Brother TWAIN Driver and click Select.</p>
<p>► Software Difficulties</p>	<p>You see the “New Hardware Found” message on your PC screen (although you have already installed the drivers in Windows 95).</p> <p>Click on ‘Do not install a driver. (Windows will not prompt you again)’ and click ‘OK’. (See page 12-10.)</p>
<p>You see the “Update Device Driver Wizard” or “Add New Hardware Wizard” message on your PC screen (although you have already installed the drivers in Windows 95 or 98).</p>	<p>Follow the instructions from the installer, then click Next. Click Finish when it appears on the screen. (See page 12-10.)</p>

	Difficulty	Suggestions
► Software Difficulties (Continued)	“Unable to write to LPT1” or “LPT1 already in use” Error Message appears.	<ol style="list-style-type: none"> 1. Make sure the MFC is on (plugged into the AC outlet) and that it is connected directly to the computer using the bundled IEEE-1284 bi-directional parallel cable. The cable must not go through another peripheral device (such as a Zip Drive, External CD-ROM Drive, or Switch box). 2. Make sure the MFC is not displaying an error message on the LCD Display. 3. Make sure no other device drivers, which also communicate through the parallel port, are running automatically when you boot up the computer (such as, drivers for Zip Drives, External CD-ROM Drive, etc.) Suggested areas to check: (<i>Load=</i>, <i>Run=</i> command lines in the <i>win.ini</i> file or the <i>Statup Group</i>) 4. Check with you computer manufacturer to confirm that the computer’s parallel port settings in the BIOS are set to support a bi-directional machine; i.e. (Parallel Port Mode – ECP)
	“MFC is Busy” or “MFC Connect Failure” Error Message appears.	
► Video Capture Difficulty	LCD does not show “Video: Press Copy Capture Ready.”	Check the video cable connection to the MFC’s RCA pin jack. Check that the video equipment is sending a signal (video equipment is turned on and set to the correct setting).
► DOS Setup Printing Difficulties	I cannot print from my application software.	Check that the DOS application software interface settings match those of your printer: for example, if you are using a parallel printer cable, you would probably set your DOS software printer port to LPT1. Check for an error message on the LCD.
	The machine prints, but it prints incorrect information. Sometimes it prints a couple of characters and then ejects the pages, etc.	This is an indication that your application printer emulation Prints setting and the machine’s printer emulation do not match. Check your application software to make sure you selected the correct printer driver. The machine emulates HP LaserJet IIP. Try setting the machine to HP emulation in Remote Printer Console and then select the HP LaserJet IIP printer in your application software.





► **Paper Handling Difficulties**

Difficulty	Suggestions
The machine prints the part of my document but does not print the last page (The LCD shows REMAINED DATA).	This is common problem first with database software and part of spreadsheet software when they are not correctly set up. The data has been sent to the printer but the printer <u>did not</u> receive the Page Eject command. Press [FF/Cont] to eject the page. Then ask your software supplier how to add a Page Eject (or Form Feed) command to the end of your print job.
How can I change the user settings or default settings on the machine?	Use the Remote Printer Console (RPC) program.
The machine does not load paper. The LCD shows CHECK PAPER or PRINTER JAM.	Check to see if the CHECK PAPER or PRINTER JAM message appears on the LCD. If so, the multi-purpose paper cassette may be out of paper or not properly installed. If it is empty, load a new stack of paper into the feeder. If there is paper in the multi-purpose paper cassette, make sure it is straight. If the paper is curled, you should straighten it. Sometimes it is helpful to remove the paper, turn the stack over and put it back into the multi-purpose paper cassette. Reduce the amount of paper in the multi-purpose paper cassette, then try again. Check the manual feed mode is not selected in the printer driver.
The machine does not feed paper from the manual feed slot.	Reinsert the paper firmly, load one sheet at a time. Make sure that manual feed mode is selected in the printer driver.
How can I load envelopes?	You can load envelopes from the manual feed slot. Your application software must be set up to print the envelope size you are using. This is usually done in the Page Setup or Document Setup menu of your software. Refer to your software application manual.
What paper can I use?	You can use plain paper, envelopes, transparencies, labels and organizer paper. (For information on paper you can use, see Acceptable Paper, on page 2-5.)
How can I clear paper jams?	See Printer Jams, on page 22-5.

► **Print Quality Difficulties**

Difficulty	Suggestions
<p>Printouts are too dark or light.</p>	<p>Adjust the print conditions by setting the Print Density function. It has been factory set to the middle position. (See Setting the Print Density, on page 5-4.)</p>
<p>Printed pages contain white stripes.</p>  <p>White Stripes or Faint Images</p>	<p>You may fix this by wiping the scanner windows with a clean soft cloth. (See Routine Maintenance and Cleaning the Drum Unit, on pages 22-17 and 22-19.) If you still see white stripes or faint images and the display shows CHANGE DRUM SOON, replace the drum unit with a new one. Check the machine's environment. Conditions such as humidity, high temperatures, etc. may cause this print defect to occur.</p>
<p>Printed pages are stained corona with toner or have vertical stripes.</p>  <p>Dark Stripes or Toner Stains</p>	<p>Clean the machine's interior and the primary wire of the drum unit. (See Routine Maintenance and Cleaning the Drum Unit, on pages 22-17 and 22-19.) Make sure that the tab of the corona wire is at the home position. If after cleaning, you still see dark stripes or toner stains and the display shows CHANGE DRUM SOON, replace the drum unit with a new one.</p>
<p>Printed pages have white spots in black text and graphic areas.</p>  <p>White Spots</p>	<p>Make sure that you use paper that meets the specifications. Rough surface or thick media can cause the problem. If you still see white spots and the display shows CHANGE DRUM SOON, replace the drum unit with a new one. Check the machine's environment; conditions such as high humidity may cause this situation to occur.</p>
<p>Toner scatters and stains the printed page.</p>  <p>Scattering Toner</p>	<p>Adjust the print conditions by setting the Print Density function. Remove the drum unit and clean the machine's interior. (See Routine Maintenance, Cleaning the Printer and Cleaning the Drum Unit, on pages 22-17 and 22-19.) Make sure that you use paper that meets specifications. (See page 2-6.) If you still have scattered toner and the display shows CHANGE DRUM SOON, replace the drum unit with a new one. Check the machine's environment; high temperature and high humidity may cause this condition to occur.</p>
<p>The whole page is printed black.</p>  <p>Black Page</p>	<p>Clean the machine's interior and the primary corona wire of the drum unit. (See page 22-19.) Also, do not use heat-sensitive paper as it will cause this problem. After cleaning, if the printed pages are still black or the display shows CHANGE DRUM SOON, replace the drum unit with a new one. The drum unit may be damaged.</p>

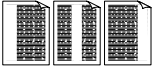
► **Print Quality Difficulties (Cont.)**

Difficulty	Suggestions
<p>Nothing is printed on the page.</p>  <p>White Page</p>	<p>Make sure that the toner cartridge is not empty. Wipe electric terminals referring to Routine Maintenance, Cleaning the Printer and Cleaning the Drum Unit, on pages 22-18 and 22-19. Make sure that a torn piece of paper does not remain on the scanner window.</p>
<p>Printed pages are marked at regular intervals.</p>  <p>Example of Regular Marking</p>	<p>Markings may disappear by themselves. Try copying multiple pages to clear this problem. Markings may occur if the machine has not been used for a long time. A possible cause is that the surface of the drum is scratched. You must then replace the drum unit with a new one. If the markings do not disappear, it may be that the drum was marked or damaged by excessive exposure to light. In this case, replace the drum unit with a new one.</p>
<p>Printed pages are blurred at the center or at either edge.</p>  <p>Blurred Page</p>	<p>Certain environmental conditions such as humidity, high temperatures, etc. may cause this condition to occur. Make sure the machine is placed on a flat, horizontal surface. Remove the drum unit with the toner cartridge installed. Try rocking them from side to side. You may clear a blurred page by wiping the scanner windows with a clean soft cloth. (See Routine Maintenance, Cleaning the Printer and Cleaning the Drum Unit, on pages 22-18 and 22-19.) If a blurred page occurs after cleaning and the display shows CHANGE DRUM SOON, replace the drum unit with a new one.</p>
<p>Ghost images appear on printed page.</p>  <p>Ghost Images</p>	<p>Adjust the print conditions by setting the Print Density function. Make sure that you use paper that meets the specifications. Rough surfaces or thick media can cause a ghost image. Make sure that you select the appropriate media type in the printer driver.</p>



The drum unit is a consumable item and it is necessary to replace it periodically.

Packing and Shipping the MFC

Whenever you transport the MFC, use the packing materials that came with your MFC. If you do not pack the MFC correctly, you could void your warranty.

- 1 Unplug the MFC from the telephone wall jack.
- 2 Unplug the MFC from the AC outlet.

WARNING

Do not unplug the MFC after a print job until you hear the final click.

Lock the Scanner Lock

Push the blue Scanner Lock Lever up to unlock the scanner. This lever is located on the rear left underside of the scanner cover.

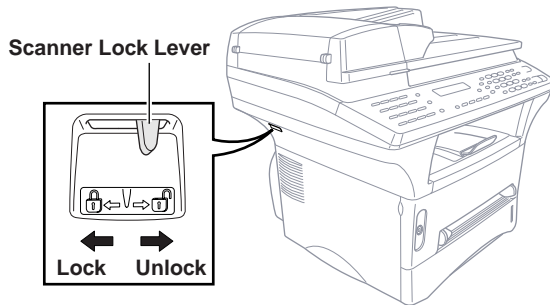

Caution

If the message “CHECK SCAN LOCK” appears on the display, unlock the scanner immediately and press **Stop**.

Caution

If the message “MACHINE ERROR AF” or “MACHINE ERROR AE” appears on the display, do not attempt to operate the machine. Call Customer Service for assistance. Customer Service phone numbers can be found on page i of your Owner’s Manual.

WARNING

Damage caused to your MFC by failure to lock the scanner before moving and shipping will void your warranty.

- 4 Open the front cover.
- 5 Remove the drum unit.

Caution

Remove the drum unit and toner cartridge assembly.
Leave the toner cartridge installed in the drum unit.

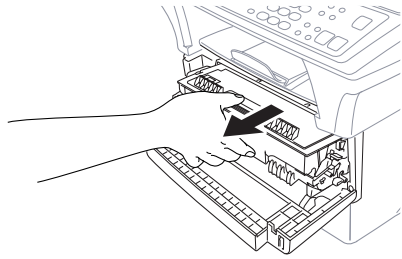

- 6 Place the drum unit and toner cartridge assembly into the plastic bag and seal the bag.

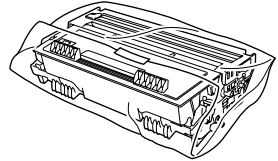

- 7 Close the front cover. Fold down the front output bin extension. Remove the telephone line cord.

- 8 Wrap the machine in the plastic bag and place it in the original carton box with the original packing material.

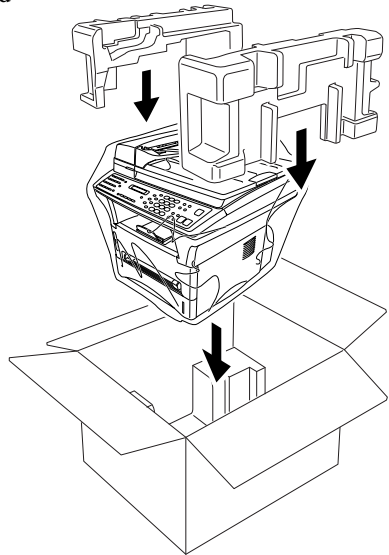
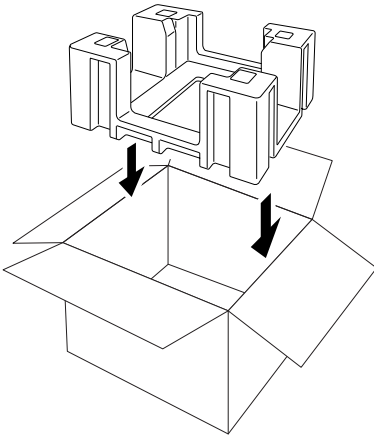

- 9** Place documents (manual and printed material) and the drum unit and toner cartridge assembly into the original carton as shown below:

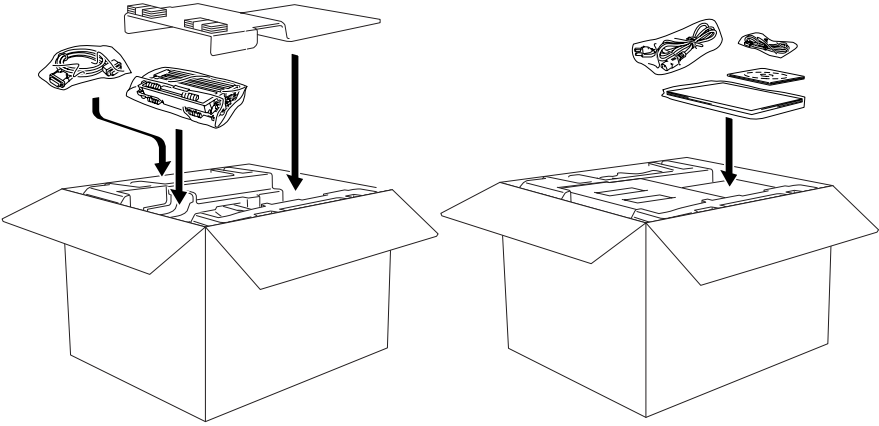

- 10** Close the carton and tape it shut.

Routine Maintenance

Cleaning the Scanner

Unplug the MFC and lift the document cover. Clean the scanner glass and the white film with isopropyl alcohol on a lint free cloth.

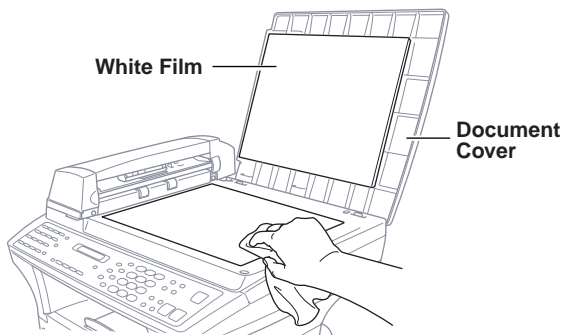

Lift the ADF unit. Clean the white roller and the glass strip under the roller with isopropyl alcohol on a lint-free cloth.

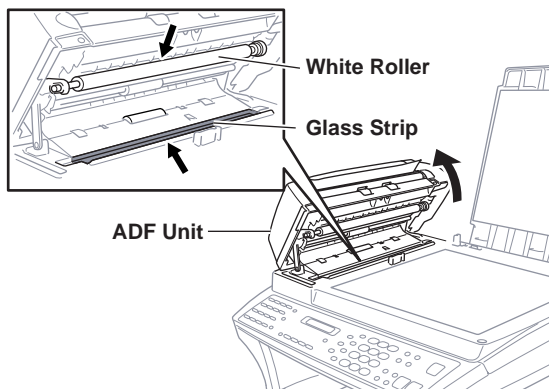

If the screen *still* displays a scanner error, call Brother Customer Service for assistance at 1-800-284-4329 (USA), 1-800-853-6660 (from within Canada), or 1-514-685-6464 (from within Montreal).

Cleaning the Printer

! Caution

- Do *not* use isopropyl alcohol to remove dirt from the control panel. It may crack the panel.
 - Do *not* use isopropyl alcohol to clean the scanner window or toner sensor.
 - Do *not* touch the scanner window with your finger.
 - The drum unit contains toner, so handle it carefully. If toner scatters and your hands or clothes get dirty, immediately wipe or wash it off with cold water.
- 1 Open the front cover.
 - 2 Remove the drum unit assembly.

! WARNING

Just after you have used the machine, some internal parts of the machine are extremely **HOT!** When you open the front cover of the machine, never touch the shaded parts as shown in the diagram below.

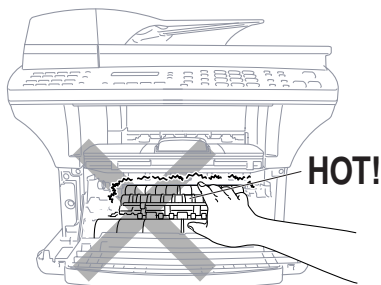

- 3 Gently clean the scanner window by wiping with a clean soft dry cloth. Do *not* use isopropyl alcohol.

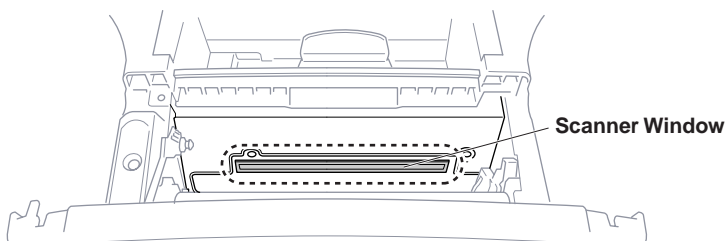

Cleaning the Drum Unit

We recommend placing the drum unit on a drop cloth or large disposable paper to avoid spilling and scattering toner.

- 1 Clean the primary corona wire inside the drum unit by gently sliding the tab from right to left several times.
- 2 Return the tab and snap it into the home position (▼).

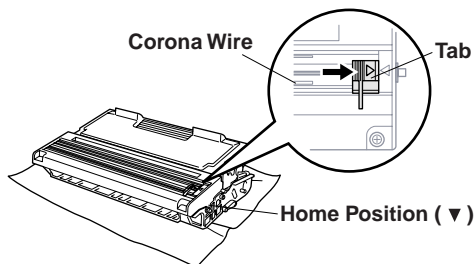

! Caution

If the tab is not at Home position, printed pages may have vertical stripes.

- 3 Reinstall the drum unit into the machine.
(See *Replacing the Drum Unit* on page 22-22.)
- 4 Close the front cover.
- 5 Plug in the power cord *first*, then the telephone cord.

Replacing the Toner Cartridge

The machine can print *up to* 6,000 pages using a *high yield* toner cartridge. When the toner cartridge is running low, the display shows TONER LOW. The machine is supplied with a *standard* toner cartridge that must be replaced after approximately 3,000 pages. Actual page count will vary depending on your average document type (i.e., standard letter, detailed graphics).

It is a good idea to keep a new toner cartridge ready for use when you see the toner low warning.

Discard the used toner cartridge according to local regulations. If you are not sure of them, your local Sanitation Department. Be sure to seal the toner cartridge tightly so toner powder does not spill out of the cartridge. When discarding used toner cartridges, keep them separate from domestic garbage.

We recommend that you clean the machine when you replace the toner cartridge.

Toner Empty Indicator

When the toner cartridge is running low, the display shows **TONER LOW** and the Toner Empty icon on the control panel flashes on and off to indicate the toner is low.

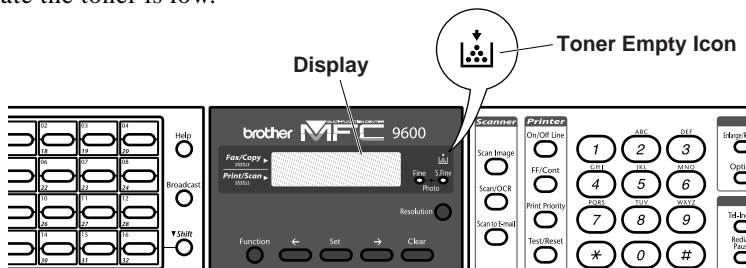

When the toner cartridge is empty, the Toner Empty icon appears and the display shows **TONER EMPTY**. Once this icon appears, your machine will not resume printing until you install a new toner cartridge.

How to Replace the Toner Cartridge

WARNING

Just after you use the machine, some internal parts of the machine will be extremely **HOT!** So, never touch the shaded parts shown in the illustration.

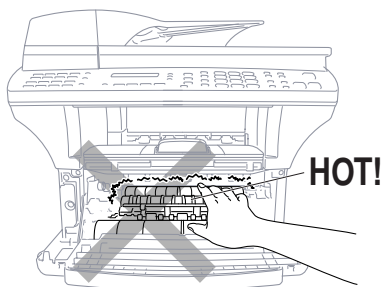

- 1 Open the front cover and pull out the drum unit.

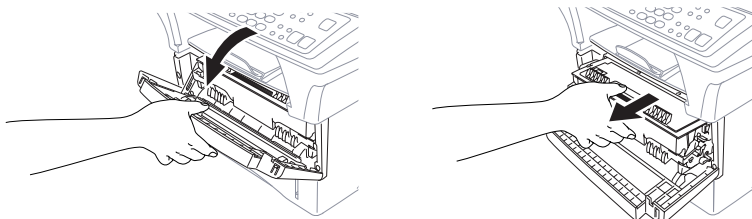

Place the drum unit on a drop cloth or large piece of disposable paper to avoid spilling and scattering the toner.

- 2 Hold down the lock lever on the right and pull the toner cartridge out of the drum unit assembly.

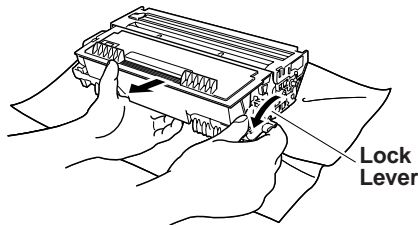

! Caution

Handle the toner cartridge carefully. If toner scatters on your hands or clothes, immediately wipe it off or wash it with cold water.

- 3 Unpack the new toner cartridge. Place the used toner cartridge into the aluminum bag and discard it according to local regulations.

! Caution

- Wait to unpack the toner cartridge until immediately before you install it into the machine. If a toner cartridge is left unpacked for a long period of time, the toner life is shortened.
- You can use only a genuine Brother toner cartridge (TN-430 or TN-460), which is specially formulated to ensure top print quality. Using another brand of toner cartridge may void your machine's warranty.

- 4 Gently rock the toner cartridge from side to side five or six times to distribute the toner evenly inside the cartridge.

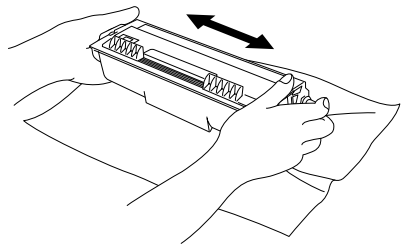

- 5 Remove the protective cover.

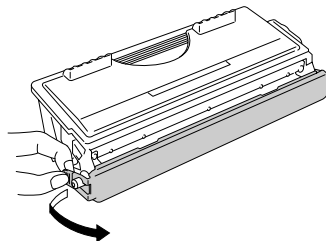

- 6 Install the new toner cartridge into the drum unit until it clicks into place.

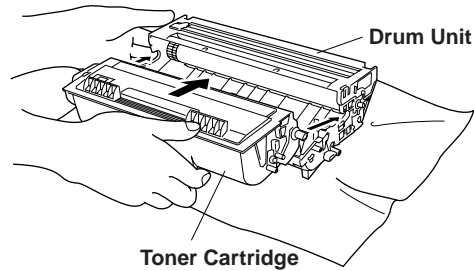

- 7 Clean the primary corona wire inside the drum unit by gently sliding the blue tab from right to left several times. Return the blue tab to the home position before reinstalling the drum unit assembly.

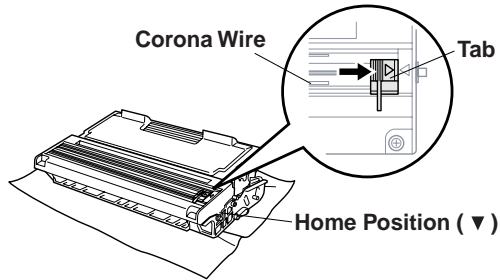

- 8 Reinstall the drum unit and close the front cover.

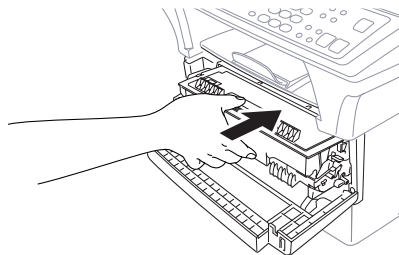

Replacing the Drum Unit

The machine uses a drum unit to create print images on paper. If the screen displays **CHANGE DRUM SOON**, the drum unit is near the end of its life and it is time to purchase a new one.

Even if the display shows **CHANGE DRUM SOON**, you may be able to continue printing without having to replace the drum unit for a while. However, if there is a noticeable deterioration in the output print quality (even before **CHANGE DRUM SOON** is shown), then the drum unit should be replaced. You should clean the machine when you replace the drum unit. (See page 22-18 to 22-19.)

Caution

When removing the drum unit, handle it carefully because it contains toner. If toner scatters and your hands or clothes get dirty, immediately wipe or wash with cold water.

 The drum unit is a consumable item, and it is necessary to replace it periodically. There are many factors that determine the actual drum life, such as temperature, humidity, type of paper and how much toner you use for the number of pages per print job, etc. The estimated drum life is *up to* 20,000 pages. The actual number of pages your drum will print may be significantly less than these estimates. Because we have no control over the many factors that determine the actual drum life, we cannot guarantee a minimum number of pages that will be printed by your drum.

 **WARNING**

Just after you have used the machine, some internal parts of the machine are extremely HOT! So please be careful.

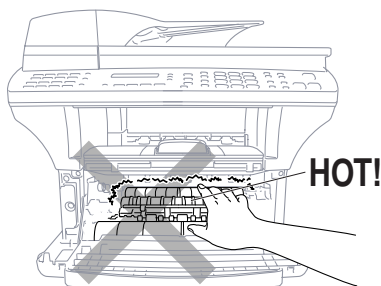

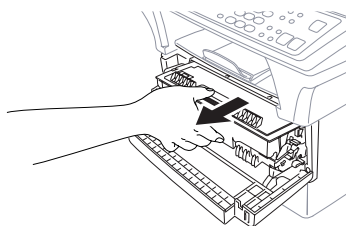

Follow these steps to replace the drum unit:

- 1** Open the front cover.
- 2** Remove the old drum unit. Place the drum unit on a drop cloth or disposable paper to avoid scattering toner.

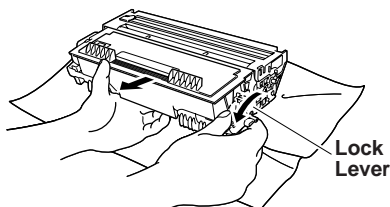

- 3** Hold down the lock lever on the right and pull the toner cartridge out of the drum unit assembly. (See *Replacing the Toner Cartridge*, page 22-19.)



-  Discard the used drum unit according to local regulations. If you are not sure of them, call your local Sanitation Department. Be sure to seal the drum unit tightly so toner powder does not spill out of the unit. When discarding used drum units, keep them separate from domestic garbage.
- 4** Wait to unpack the new drum unit until immediately before installing it. Place the old drum unit into the aluminium bag and discard it according to local regulations.
- 5** Reinstall the toner cartridge into the new drum unit. (See *Replacing the Toner Cartridge*, page 22-19.)

6 Reinstall the new drum unit, keeping the front cover *open*.

7 Press **Clear**.

8 Press **1** and when the display shows ACCEPTED, and close the front cover.

```
REPLACE DRUM?  
1.YES 2.NO
```

Caution

If toner scatters and your hands or clothes get dirty, immediately wipe off or wash with cold water.

Checking the Drum Life

You can see the percentage of the drum's life that remains available.

1 Press **Function**, **1**, **0**, **3**.

2 For five seconds, the screen displays the available percentage of drum life.

```
DRUM LIFE  
REMAINING: 70%
```

 Even if the remaining drum life is 0%, you may continue to use the drum unit until you have a print quality problem.

For Customer Service

USA: 1-800-284-4329 (voice)

1-908-575-8790 (fax)

From within Canada: 1-800-853-6660 (voice)

1-514-685-4898 (fax)

From within Montreal: 1-514-685-6464 (voice)

23 Using the Brother MFC with a New Power Macintosh® G3 or iMac™

Connecting Your USB Equipped Apple Macintosh G3 or iMac with Mac OS 8.5/8.6

Connect your USB Equipped Apple Macintosh G3 or iMac with Mac OS 8.5/8.6 to your MFC:

- 1 Set up your MFC and make sure that it is working properly.
- 2 Unplug the MFC's AC power cord and turn off the AC power to your Macintosh G3 or iMac.
- 3 Connect a standard USB cable to both the MFC and the Macintosh G3 or iMac.

Installing the Brother Printer and Scanner Drivers

- 1 Turn on the power to your Macintosh G3 or iMac and Wait for the startup process to be completed.
- 2 Plug in the MFC power cord to turn it on.
- 3 Insert the Brother CD-ROM into your CD-ROM drive. The CD-ROM icon will appear on the desktop.
- 4 Double-click the **Start Here** icon in the CD-ROM's folder. The installer screen will appear:

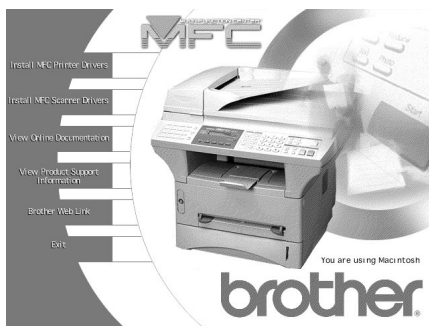

- 5 Click **Install MFC Printer Driver** to begin the installation.

- 6 Click **Install MFC Scanner Driver** to begin the installation.
- 7 After you have installed the Drivers, click **View On-Line Documentation** for operation instructions.



Restart your Macintosh G3 or iMac so it can recognize the new drivers.

Using Brother TWAIN Scanner Driver with Your Apple Macintosh G3 or iMac

The Brother MFC software includes an Apple TWAIN Scanner driver for Macintosh G3 or iMac. This Macintosh TWAIN Scanner driver can be used with any application that supports the TWAIN specification.

Most image editing applications support the TWAIN specification. For example, Kai's Power Soap is standard software with iMac and it supports a TWAIN driver, so Kai's Power Soap can scan images from the Brother machine.

Importing Images

Although Brother does not bundle OCR software for the Macintosh G3/iMac, many editing and OCR software products are available for Macintosh G3/iMac. Make sure your OCR application supports the TWAIN specification. Then you can choose the Brother TWAIN Scanner driver from that application.

Importing images is independent of the Brother MFC Macintosh G3/iMac software. The file formats that are supported depend on the application you are using.

To check the file formats that are supported, run your image editing application and choose the Import option on the File or Edit menu.

Exporting Images in Other Formats

When you use an industry standard TWAIN driver (the Brother TWAIN Driver) the exportable file formats depend on the software application you are using. Typically, the more sophisticated or expensive the image editing application, the more file formats that are supported.

To check the file formats that are supported, run your image editing application and choose the Export option on the File or Edit menu.

Accessing the Scanner

Run your image editing application, such as Photoshop, Kai's Photo Soap. The first time you use the Brother TWAIN driver, set it as the default by choosing the "Select TWAIN Source" menu option. Aferward, for each original you scan choose "TWAIN Acquire" (for example: File>Import>TWAIN>Acquire). The Scanner setup dialog box will appear.

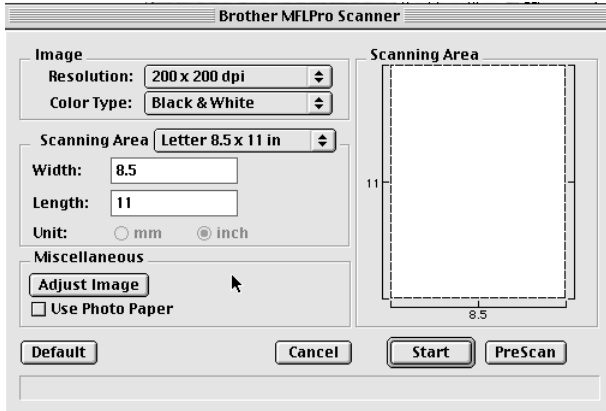

Scanning a Document into Your Macintosh G3 or iMac

- 1 Insert the document(s) in the ADF of the MFC.
- 2 Adjust the following settings, if needed, in the scanner setup dialog box:
 - Resolution*
 - Gray Scale (Black & White, Gray (Error Diffusion), True Gray)*
 - Brightness*
 - Contrast*
 - Size*
- 3 Click **Start**.

When the scanning is finished, the image will appear in your graphics application.

Settings in the Scanner Window

Image

Resolution

Resolution—Choose the scanning resolution from the Resolution pop-up menu. Higher resolutions take more memory and transfer time, but can achieve a finer scanned image.

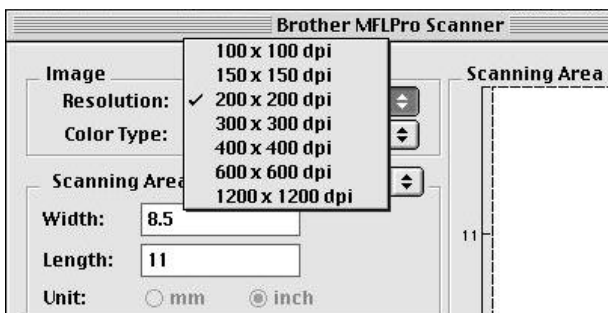

Color Type

Black & White—Set the image Type to Black&White for text or line art. For photographic images, set the image type to Gray (Error diffusion) or True Gray.

Gray (Error Diffusion)—is used for documents that contain photographic images or graphics. (Error Diffusion is a method for creating simulated gray images by placing black dots in a specific matrix instead of true gray dots.)

True Gray—also is used for documents containing photographic images or graphics. This mode is more exact because it uses up to 256 shades of gray. It requires the most memory and longest transfer time.

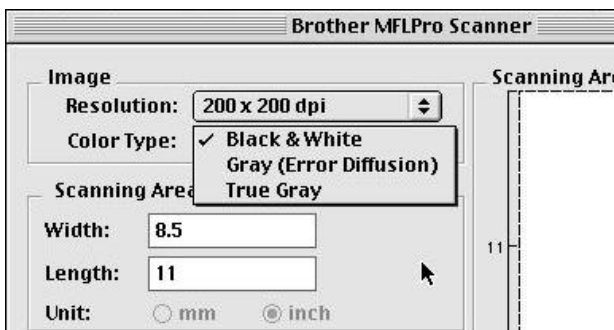

Scanning Area

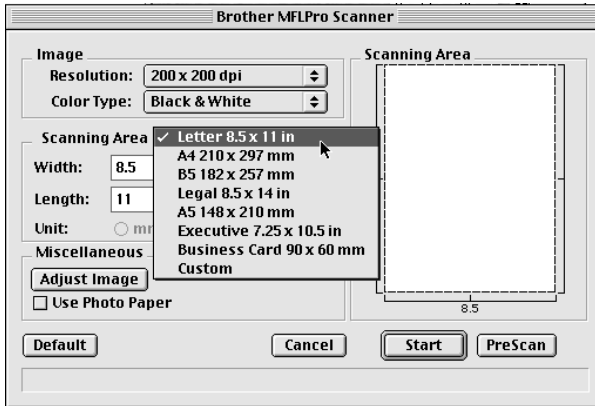

Set the Size to one of the following:

- Letter (8.5 x 11 inches)
- A4 (210 x 297 mm)
- Legal (8.5 x 14 inches)
- A5 (148 x 210 mm)
- B5 (182 x 257 mm)
- Executive (7.25 x 10.5 inches)
- Business Card (90 x 60 mm)
- Custom (User adjustable from 0.35 x 0.35 inches to 8.5 x 14 inches)

After you choose a custom size, you can adjust the scanning area. Click and hold the mouse button as you drag the mouse to crop the image.

Width : Enter the width of the custom size.

Length : Enter the length of the custom size.

Business Card Size

To scan business cards, select the Business Card size setting (90 x 60 mm) and place the business card at the top center of a carrier sheet.



Carrier sheets are available from your Dealer.

When scanning photographs or other images for use in a word processor or other graphics application, it is a good idea to try different settings for the contrast, mode and resolution to determine which settings look best.

Miscellaneous

Brightness

Brightness—Adjust the brightness settings to obtain the best image. The Brother TWAIN Scanner driver offers 100 brightness settings (-50 to 50). The default value is 0, representing an “average” setting.

You can set the brightness level by dragging the slider to the right to lighten the image or to the left to darken the image. You can also type a value in the box to set the setting. Click **OK**.

If the scanned image is too light, set a lower brightness value and scan the document again.

If the image is too dark, set a higher brightness value and scan the document again.

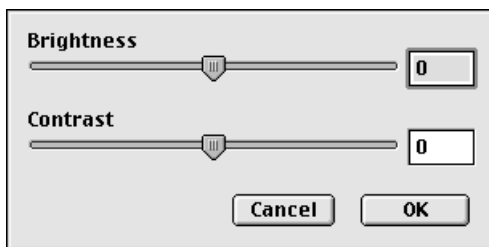

Contrast

The contrast setting is adjustable only when you have selected one of the gray scale settings, but it is not available when Black & White is selected as the Gray Scale.

Increasing the contrast level (by dragging the slider to the right) emphasizes dark and light areas of the Image, while decreasing the contrast level (by dragging the slider to the left) reveals more detail in gray areas. Instead of using the slider, you can type a value in the box to set the contrast. Click **OK**.

PreScanning an Image

PreScanning allows you to scan an image quickly at a low resolution. A thumbnail version will appear in the Scanning Area. This is only a preview of the image, so you can see how it will look. The **PreScan** button is used to preview an image for cropping any unwanted portions from the image. When you are satisfied with the preview, click **Start** to scan the image.

- 1 Insert original in ADF feeder of the Brother MFC.
- 2 Click **PreScan**.

The entire original will be scanned into your Macintosh G3 or iMac and will appear in the Scanning Area of the Scanner dialog box:

- 3 To scan a portion of the prescanned image, click and drag the mouse to crop it.

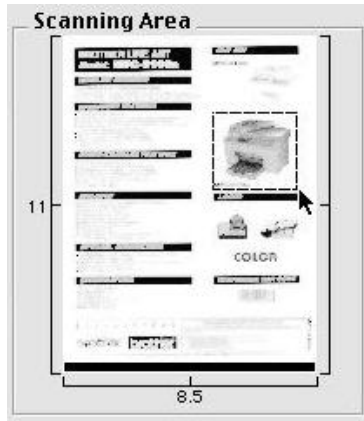

- 4 Insert original in the ADF of the Brother MFC again.
- 5 Adjust the settings for Resolution, Color Type (Gray Scale), Brightness, Contrast, and Size in the Scanner Setup dialog box, as needed.
- 6 Click **Start**.

This time only the selected area of the original will appear in the Scanning Area.

- 7 In your editing software application, refine the image as usual.

Glossary

- Activity Report** Lists information about the last 50 incoming and outgoing faxes. TX means Transmit. RX means Receive.
- ADF (Automatic Document Feeder)** Originals can be placed in the ADF and scanned one at a time automatically.
- All Dial List** A listing of names and numbers stored in One Touch and Speed Dial memory, in numerical order.
- Automatic E-Mail Printing** Software application that automatically prints incoming e-mail messages on the MFC (on CD-ROM 1).
- automatic fax transmission** Sending a fax without pressing .
- Automatic Redial** A feature that enables your MFC to redial the last fax number if the original fax did not go through because the line was busy.
- Backup Print** Sets your MFC to print a copy of faxes that are received and stored in memory.
- batch transmission** As a cost savings feature, all delayed faxes to the same fax number will be sent as one transmission.
- beeper** The sound the keys make when they are pressed, an error occurs or a document has been received or transmitted.
- beeper volume** Volume setting for the beep when you press a key or make an error.
- broadcasting** The ability to send the same fax message to more than one location.
- Brother Control Center** A window that enables you to click on a button to choose the type of scanning operation you want to perform. If you set up the Control Center window to load each time you boot your PC, this window will appear each time you place a original in the ADF.
- Caller ID** A service purchased from the Telephone Company that lets you see the number (or name) of the party calling you. Your MFC stores the latest callers so you can print a Log, view caller information, register selected callers as auto dial numbers.
- Cancel Job** Cancels a programmed job, like Delayed Fax or Polling.
- CNG tones** The special tones (beeps) sent by fax machines during automatic transmission to tell the receiving machine that they are a from fax machine.
- communication error (or Comm. Error)** An error during fax sending or receiving, usually caused by line noise or static.
- Coding Method** Method of coding the information contained in a document. All fax machines must use a minimum standard of Modified Huffman (MH). Your fax machine is capable of greater compression methods, Modified Read (MR) Modified Modified Read (MMR) and Joint Bi-level Image export working Group (JBIG) if the receiving machine has the same capability.

- Compatibility Group** The ability of one fax unit to communicate with another. Compatibility is assured between ITU-T Groups.
- Contrast** Setting to compensate for dark or light documents, by lightening dark documents or darkening light documents.
- Cover Page** Prints a page at the other party's machine, that contains the sender and recipient's name and fax number, number of pages and comment. You can generate an electronic cover page at the other end with pre-programmed information from memory or you can print a sample cover page to fax with your original.
- Cover Page Message** The comment that is on the Cover Page. This is a programmable feature.
- Delayed Fax** Sends your fax at a later time that day.
- Delayed Timer** You can program a certain time each day that all delayed faxes will be sent on a first come/first served basis.
- Distinctive Ring** A service purchased from your telephone company that provides another phone number on an existing phone line. The Brother MFC uses the new number to simulate a dedicated fax line.
- Dual Access** Your MFC can scan outgoing faxes or scheduled jobs into memory at the same time it is sending a fax or receiving or printing an incoming fax.
- Easy Receive** Enables your MFC to respond to CNG tones if you interrupt a fax call by answering it.
- ECM (Error Correction Mode)** Detects errors during fax transmission and automatically resends the page(s) of the original that had an error.
- Electronic Cover Page** A preprogrammed cover page that is transmitted from the fax machine's memory, eliminating the need for making up cover pages manually.
- E-Mail Printing** Software application that automatically retrieves your e-mail messages from your POP3 server and prints them on your MFC.
- extension phone** A telephone on the fax number that is plugged into a separate wall jack.
- external phone** A TAD (telephone answering device) or telephone that is plugged into the EXT jack of your MFC.
- Fax Forwarding** Sends a fax received in memory to another preprogrammed fax number.
- Fax Storage** The MFC 9600 can save up to 700 fax pages in memory. You can print stored faxes later, or retrieve them from another location using Fax Forwarding, Paging, or Remote Retrieval functions.
- fax tones** The signals sent by sending and receiving fax machines while communicating information.
- Fine Mode** Resolution is 196 x 203 dpi. It is used for small print and graphs.

- Function Mode** Programming mode for changing the settings of your MFC.
- gray scale** The shades of gray available for copying and faxing photographs.
- group number** A combination of One Touch and/or Speed Dial numbers that are stored on a One Touch key for Broadcasting.
- interval** The preprogrammed time period between automatically printed Activity Reports. You can print Activity Reports on demand without interrupting this cycle.
- LCD (liquid crystal display)** The display screen on the MFC that shows interactive messages during On-Screen Programming and defaults to the date and time when the machine is idle.
- manual fax** When you press **Hook** so you can hear the receiving fax machine answer before you press **Start** to begin transmission.
- Memory Status Report** Shows how much memory is being used, how much is left, and the type of messages in memory.
- memory usage** Instructs the MFC how to allocate the memory.
- Multi-Function Link® Pro software** Turns your MFC into a printer and a scanner and enables PC faxing using the MFC.
- NetCentric™ FaxStorm Software application** Brings together the power of the Internet and the reliability of fax using Internet faxing from your desktop.
- OCR (optical character recognition)** The bundled TextBridge® software application converts an image of text to text you can edit.
- One Touch** Keys on the MFC control panel where you can store numbers for easy dialing. You must use a separate key for each number.
- Out of Paper Reception** Receives faxes into the MFC's memory when the machine is out of paper.
- Overseas Mode** Makes temporary changes to the fax tones to accommodate noise and static on overseas phone lines.
- Paging** Feature enables your fax unit to call your pager when a fax message is received into its memory.
- ScanSoft™ PaperPort® for Brother** Document management application where you can view received faxes and scanned originals.
- Pause** Allows you to place a 3.5 second delay in the dialing sequence stored on One Touch and Speed Dial numbers.
- Photo Mode** A resolution setting that uses varying shades of gray for the best representation of photographs.
- polling** The process of a fax machine calling another fax machine to retrieve waiting fax messages.
- printer alarm** Audible alarm when the printer is not able to print.
- print reduction** reduces the size of incoming faxes.
- Pulse** A form of dialing on a telephone line.

- Real Time Transmission** When memory is full, send documents in real time.
- remote retrieval access** The ability to access your MFC remotely from a touch tone phone.
- remaining jobs** You can check which jobs are waiting in memory and cancel jobs individually.
- remote retrieval access code** The four-digit code (159✳) that allows you to call your MFC to retrieve fax messages or change fax storage settings.
- remote activation** allows you to transfer a fax call, answered at an external or extension phone, to the MFC.
- resolution** The number of vertical and horizontal lines per inch. See: Standard, Super Fine and Photo.
- Ring Delay** The number of rings before the MFC answers in FAX mode.
- Ring Volume** Volume setting for the MFC's ring.
- Rotary** A form of dialing on a telephone line.
- scanning** The process of sending an electronic image of an original paper document into your computer.
- Speaker Volume** You can set the volume of the  key.
- speed dial** A preprogrammed number for easy dialing. You must press the Speed dial button and then two digit code to start the dialing process.
- Standard resolution** 98 x 203 dpi. It is used for regular size text and quickest transmission.
- Station ID** The stored information that appears on the top of faxed pages. It includes the sender's name and fax number.
- super fine resolution** 392 x 203 dpi. Best for very small print and line art.
- TAD (telephone answering device)** You can connect an external TAD to the EXT. jack for EXT. TEL/TAD mode.
- Tel-index** An electronic, alphabetical listing of stored One Touch, Speed Dial and Group numbers.
- temporary settings** You can select certain options for each fax transmission without changing the default settings.
- Tone** A form of dialing on the telephone line used for Touch Tone telephones.
- transmission** The process of sending documents over the phone lines from your MFC to the receiving fax machine.
- True Type fonts** The fonts that are used in the Windows® operating systems. If you install the Brother True Type fonts, more types of fonts will be available for Windows® applications.
- User Option List** Printed report of your MFC's current settings.
- Xmit Report (Transmission Report)** A listing of each transmission, showing caller ID, date, time, and number of pages.

Specifications

Product Description

Six performance modes are available for the 6in1 model MFC 9600:
Fax, Printer, Copier, Scanner, PC Fax and Video Capture.

Fax Specifications

Compatibility	ITU-T Group 3
Coding System	MH/MR/MMR/JBIG
Modem Speed	14400/12000/9600/7200/4800/2400 Automatic Fallback
Document Size	ADF Width: 5.8" to 8.5" (148 mm to 216 mm) ADF Length: 5.0" to 14.0" (127 mm to 356 mm) Scanner Width: Max. 8.5" (216 mm) Scanner Length: Max. 11.7" (297 mm)
Scanning/Printing Width	8.2 inches (208 mm)
Paper Cassette	250 Sheets (20 lbs.)
Gray Scale	64 levels
Display	LCD, 16 characters x 2
Polling Types	Standard, Sequential
Contrast Control	Automatic/Super Light/Super Dark (manual setting)
Resolution	<ul style="list-style-type: none">• Horizontal 203 dot/inch (8 dot/mm)• Vertical Standard—98 line/inch (3.85 line/mm) Fine, Photo—196 line/inch (7.7 line/mm) Superfine, Photo—392 line/inch (15.4 line/mm)
Memory Capacity	8 MB (up to 750 pages)*
One Touch Dial	16 x 2
Speed Dial	100 stations
Automatic Redial	3 times at 5 minute intervals
Auto Answer	0, 1, 2, 3 or 4 rings

* Using Brother #1 chart, with JBIG coding and Standard Resolution

Fax Specifications (Continued)

Communication Source	Public switched telephone network.
Temperature	(Allowable) 50 - 90.5° F (10 - 32.5° C) (Storage) 32 - 104° F (0 - 40° C)
Warm-Up	Max. 45 seconds at 73.4° F (23° C)
First Print	15 seconds (using Letter size paper in paper cassette)
Power Source	120V AC 50/60Hz (Canadian Version Only)
Power Consumption	Average Operating (Copying): 330 W Peak: 850 W (25° C) Sleep: 14 W or less Standby: 60 W or less
Noise	Operating: 50 dB A or less Stand by: 39 dB A or less
Humidity	Operating: 20 to 80% (without condensation) Storage: 20 to 80% (without condensation)
Dimensions	19.4 x 18.0 x 16.8 inches/(492 x 456 x 429 mm)
Weight	35.2 lbs/(17 kg)

* "Pages" refers to the "Brother Standard Chart No. 1" (a typical business letter, Standard resolution). Specifications and printed materials are subject to change for improvement without prior notice.

Printer Specifications

Emulation	Brother Printing System for Windows® and emulation mode of HP LaserJet IIP (PCL level 4)
Printer Driver	Windows® 3.1x, Windows® 95/98 and Windows NT® Workstation Version 4.0 driver supporting Brother Native Compression mode and bi-directional capability
Interface	Bi-directional parallel (IEEE-1284); USB (Universal Serial Bus) Interface Using Windows® 98 Only:
Memory Capacity	8 MB
Print Method	Electrophotography by semiconductor laser beam scanning
Resolution	600 dots/inch
Print Quality	Normal printing mode Economy printing mode (saves up to 50% of the normal toner usage)
Print Speed	Up to 12 pages/minute (when loading letter size or A4 paper from paper cassette)

Consumable Items Toner cartridge Life Expectancy:
 Up to 6,000 pages/*high yield* toner cartridges
 Up to 3,000 pages/*standard* toner cartridges
 (when printing letter size or A4 paper at 5% print coverage)

 Toner life expectancy will vary depending upon the type of average print job.
 Drum Unit Life Expectancy: up to 20,000 pages

 There are many factors that determine the actual drum life, such as temperature, humidity, type of paper, toner you use, number of pages per print job, etc.

True Type Fonts TrueType compatible soft-fonts for Windows® on the
on CD-ROM bundled CD-ROM

Parallel Interface Specifications

Interface Connector Printer Side: Amphenol FCN-685J036-L/X or equivalent
 A shielded cable should be used.

Pin Assignment

Pin No.	Signal	Direction	Pin No.	Signal	Direction
1	DATA STROBE	Input	19	0V(S.G.)	-
2	DATA 1	Input	20	0V(S.G.)	-
3	DTAT 2	Input	21	0V(S.G.)	-
4	DATA 3	Input	22	0V(S.G.)	-
5	DATA 4	Input	23	0V(S.G.)	-
6	DATA 5	Input	24	0V(S.G.)	-
7	DATA 6	Input	25	0V(S.G.)	-
8	DATA 7	Input	26	0V(S.G.)	-
9	<u>DATA 8</u>	Input	27	0V(S.G.)	-
10	<u>ACKNLG</u>	Output	28	0V(S.G.)	-
11	BUSY	Output	29	0V(S.G.)	-
12	PE	Output	30	<u>0V(S.G.)</u>	-
13	<u>SLCT</u>	Output	31	<u>INPUT PRIME</u>	Input
14	AUTO FEED	Input	32	<u>FAULT</u>	Output
15	N.C.	-	33	N.C.	-
16	0V (S.G.)	-	34	N.C.	-
17	0V (S.G.)	-	35	<u>N.C.</u>	-
18	+5V	-	36	<u>SLCT IN</u>	Input

USB (Universal Serial Bus) Interface Specifications

Pin Assignment

Pin No.	Signal
1	Vol (+5V)
2	- Data Serial Data -
3	+ Data Serial Data +
4	Ground

Resident Fonts

The following bitmapped fonts are resident in the machine.

Brougham 10 (12 point) upright/normal

Brougham 12 (10 point) upright/normal

Letter Gothic 16.66 (8.5 point) upright/normal

(Portrait and Landscape are available for the above.)

Symbol Sets/Character Sets

*HP mode

- ISO14 JIS ASCII • Roman 8
- ISO57 Chinese • ISO Latin 1
- ISO11 Swedish (ECMA-94)
- HP Spanish • ISO60 Norwegian 1
- ISO17 Spanish • ISO61 Norwegian 2
- ISO10 Swedish • ISO4 UK
- ISO16 Portuguese • ISO25 French
- ISO84 Portuguese • ISO69 French
- ISO85 Spanish • HP German
- PC-8 • ISO21 German
- PC-8 D/N • ISO15 Italian
- PC-8 Turkish • ISO6 ASCII
- PC-850 • Legal
- PC-852 • ISO2 IRV
- PC-860 • PC-863
- PC-865



If you want to know which characters are in each symbol/character set, print the CHARSETS.PRN file from “The Print Form” option in the Direct Access Menu of the Remote Printer Console Program.

□ HP LaserJet IIP

Roman 8										ISO Latin1																							
0	1	2	3	4	5	6	7	8	9	A	B	C	D	E	F	0	1	2	3	4	5	6	7	8	9	A	B	C	D	E	F		
0		0	@	P	'	p				A	—	À	Á	Â	Ã	Ä	0		0	@	P	'	p				A	°	À	Á	Â	Ã	Ä
1	!	1	A	Q	a	q				À	Á	Â	Ã	Ä	Å	Æ	1	!	1	A	Q	a	q				±	±	À	Á	Â	Ã	Ä
2	"	2	B	R	b	r				Ä	Å	Æ	Ç	È	É	Ê	2	"	2	B	R	b	r				ç	ç	À	Á	Â	Ã	Ä
3	#	3	C	S	c	s				È	É	Ê	Ë	Ì	Í	Î	3	#	3	C	S	c	s				è	è	À	Á	Â	Ã	Ä
4	\$	4	D	T	d	t				É	Ê	Ë	Ì	Í	Î	Ï	4	\$	4	D	T	d	t				é	é	À	Á	Â	Ã	Ä
5	%	5	E	U	e	u				Ê	Ë	Ì	Í	Î	Ï	Ð	5	%	5	E	U	e	u				ê	ê	À	Á	Â	Ã	Ä
6	&	6	F	V	f	v				Ë	Ì	Í	Î	Ï	Ð	Ñ	6	&	6	F	V	f	v				ë	ë	À	Á	Â	Ã	Ä
7	'	7	G	W	g	w				Ì	Í	Î	Ï	Ð	Ñ	Ò	7	'	7	G	W	g	w				ì	ì	À	Á	Â	Ã	Ä
8	(8	H	X	h	x				Í	Î	Ï	Ð	Ñ	Ò	Ó	8	(8	H	X	h	x				í	í	À	Á	Â	Ã	Ä
9)	9	I	Y	i	y				Î	Ï	Ð	Ñ	Ò	Ó	Ô	9)	9	I	Y	i	y				î	î	À	Á	Â	Ã	Ä
A	*	:	J	Z	j	z				Ï	Ð	Ñ	Ò	Ó	Ô	Õ	A	*	:	J	Z	j	z				ï	ï	À	Á	Â	Ã	Ä
B	+	;	K	[k	{				Ð	Ñ	Ò	Ó	Ô	Õ	Ö	B	+	;	K	[k	{				«	«	À	Á	Â	Ã	Ä
C	,	<	L	\	l					Ñ	Ò	Ó	Ô	Õ	Ö	Ø	C	,	<	L	\	l					»	»	À	Á	Â	Ã	Ä
D	-	=	M	\	m	}				Ò	Ó	Ô	Õ	Ö	Ø	Ù	D	-	=	M	\	m	}				¼	¼	À	Á	Â	Ã	Ä
E	.	>	N	^	n	~				Ó	Ô	Õ	Ö	Ø	Ù	Ú	E	.	>	N	^	n	~				½	½	À	Á	Â	Ã	Ä
F	/	?	O	_	o	¸				Ô	Õ	Ö	Ø	Ù	Ú	Û	F	/	?	O	_	o	¸				¾	¾	À	Á	Â	Ã	Ä

The following table shows characters available only in the corresponding character set. The numbers at the top of the table are code values with which characters are to be replaced in the Roman 8 character set. For other characters, see character set of Roman 8.

SYMBOL SET	23	24	40	5B	5C	5D	5E	60	7B	7C	7D	7E
ISO2 IRV	#	¤	@	[\]	^	`	{		}	—
ISO4 UK	£	\$	@	[\]	^	`	{		}	—
ISO6 ASCII	#	\$	@	[\]	^	`	{		}	-
ISO10 Swedish	#	¤	@	Ä	Ö	Å	^	`	ä	ö	å	-
ISO11 Swedish	#	¤	É	Ä	Ö	Å	Ü	é	ä	ö	å	ü
ISO14 JIS ASCII	#	\$	@	[¥]	^	`	{		}	—
ISO15 Italian	£	\$	§	°	ç	é	^	ù	à	ò	è	ì
ISO16 Portuguese	#	\$	§	À	Ç	Õ	^	^	ã	ç	õ	°
ISO17 Spanish	£	\$	§	¡	Ñ	¿	^	^	ñ	ç	-	-
ISO21 German	#	\$	§	Ä	Ö	Ü	^	^	ä	ö	ü	ß
ISO25 French	£	\$	à	°	ç	§	^	^	é	ù	è	¨
ISO57 Chinese	#	¥	@	[\]	^	`	{		}	—
ISO60 Norwegian1	#	\$	@	Æ	Ø	Å	^	`	æ	ø	å	—
ISO61 Norwegian2	§	\$	@	Æ	Ø	Å	^	`	æ	ø	å	
ISO69 French	£	\$	à	°	ç	§	^	μ	é	ù	è	¨
ISO84 Portuguese	#	\$	·	À	Ç	Õ	^	^	ã	ç	õ	¨
ISO85 Spanish	#	\$	·	¡	Ñ	¿	^	^	ñ	ç	-	-
HP German	£	\$	§	Ä	Ö	Ü	^	^	ä	ö	ü	ß
HP Spanish	#	\$	@	¡	Ñ	¿	°	`	{	ñ	}	—

Index

A

- access codes, storing 7-6
- accessories and supplies ii
- ADF (automatic document feeder) 6-1
- answer mode
 - EXT. TEL/TAD 5-1
 - FAX 5-1
 - manual 5-1
- answering machine. *See TAD (telephone answering device)*
- Apple® (iMac and Macintosh® 6-3)
 - connecting 23-1
 - installing drivers 23-1
 - scanning 23-2 to 23-7
- assembly 2-4
 - drum unit assembly 2-4
 - loading paper 2-6
 - power cord 2-8
 - toner cartridge 2-4
- assembly of MFC 2-8
 - grounded 3-prong plug 2-8
 - telephone line cord 2-8
- automatic
 - dialing 7-4
 - fax receive 5-1
 - fax redial 6-5
 - transmission 6-4

B

- beeper 4-3
- bi-directional parallel cable 12-10
- brightness. *See video printing (walk-up)*
- Broadcasting 7-5
 - setting up Groups for 7-3
- Brother
 - accessories and supplies ii
 - Bulletin Board i
 - contact numbers i
 - Customer Service i
 - fax-back system i

Frequently Asked Questions (FAQs) i

test sheet, sending 1-1

warranty

Canada vi

Notice-Disclaimer of

Warranties iii

USA iv

Brother Control Center 15-1

using and configuring 15-2 to 15-16

C

Caller ID 5-9

clearing from memory 5-10

printing list 5-9

viewing 5-9

canceling

fax forwarding 8-4

fax jobs in memory 5-7

jobs, awaiting redial 6-7

paging 8-4

print jobs 14-7

cartridge. *See toner cartridge*

cleaning

drum unit 22-19

printer 22-18

scanner 22-17

CNG tones 1-4

computer

requirements 12-2

contrast 6-4

Control Center. *See Brother Control Center*

control panel 1-2

converting telephone wall outlets 2-11

copy(ies) 10-1

contrast 10-3

quality 22-8

reducing 10-4

single 10-1

using ADF 10-1

using scanner glass 10-2

cover page
 composing 6-7
 custom comments 6-8
 for all faxes 6-9
 for next fax only 6-8
 printed form 6-9
credit card numbers, storing 7-6
custom telephone features 2-13, 22-8
Customer Service i

D

date and time setting 4-1
delayed fax 6-10
dialing
 access codes 7-6
 automatic fax redial 6-5
 credit card numbers 7-6
 Groups 7-5
 manually 6-5
 One Touch numbers 7-4
 pulse (rotary) 4-1
 Speed Dial numbers 7-4
 telephone index 7-4
 tone 4-1
difficulties with machine. *See troubleshooting*
document jam 22-4
drivers
 fax 16-4
 installing
 iMac™/Macintosh® G3 23-1
 Windows® Parallel 12-12
 Windows® USB 12-4
 printing 14-1
 TWAIN compliant 17-6
drum unit
 cleaning 22-19
 installing 2-4
 life remaining 22-24
 replacing 22-22
dual access 6-5

E

Easy Receive 5-2
ECM (Error Correction Mode) 1-4
emergency numbers 21-1
enlarging 10-4
entering text 4-2
envelopes
 sizes 2-5
error messages on LCD 22-2 to 22-4
 CHECK PAPER 22-2
 COMM. ERROR 22-2
 MEMORY FULL 10-3
 NOT REGISTERED 22-3
extension telephones, using 5-5
external TAD. *See TAD (telephone answering device)*
external telephone 2-9

F

fax codes
 changing 5-5
 Fax Receive Code 5-5
 Remote Retrieval Access Code 8-3
 troubleshooting 5-5
Fax Forwarding
 changing remotely 8-4, 8-6
 programming a number 8-2
 setting up at MFC 8-2
Fax Receive Code 5-5
Fax Storage
 printing from 5-5
 setting 8-2
fax tones 1-4
fax(es) in PC. *See Multi-Function Link® Pro*
fax(es), stand-alone
 receiving 5-1
 difficulties 22-7
 erasing from memory 8-4
 forwarding 8-2, 8-4
 polling 5-6
 printing from memory 5-5
 reducing to fit on paper 5-3
 retrieving from a remote site 8-5

sending 6-1
 automatic fax redial 6-5
 automatic transmission 6-4
 broadcasting 7-5
 canceling from memory 6-7
 contrast 6-4
 cover page. *See cover page*
 delayed 6-10
 from memory (dual access) 6-5
 in real time 6-6
 manual transmission 6-5
 overseas 6-10
 polling 6-12. *See also polling*
 resolution 6-4
 timer for delayed sending 4-5
 using multiple settings 6-1
 using scanner glass 6-3
fax-back system i
FCC notices 21-1 to 21-3
FF/Cont key 14-7
Fine. *See resolution*
fixed reduction 5-3
function(s)
 mode 3-1
 programming at-a-glance 3-2 to 3-6

G

gray scale 17-8, 23-4
Groups
 dialing 7-5
 setting up 7-3

H

Help List, printing 3-1

I

iMac™. *See Apple®*
inserting space 4-3
installing Multi-Function Link®
 Pro. *See Chapter 12*

J

jack(s)
 converting wall jacks. *See triplex adapter*
 EXT. jack on MFC
 external telephone 2-9
 TAD (answering machine) 2-9

L

LCD (Liquid Crystal Display) 3-1
location for MFC, choosing 2-2

M

Macintosh® G3. *See Apple®*
maintenance, routine
 cartridge. *See cartridge cleaning. See cleaning*
manual
 mode (receive) 5-1
 transmission 6-5
manual feed slot 2-5, 2-7
memory, additional 20-1
memory full. *See error messages on LCD*
Memory Status List 8-5
Multi-Function Link® Pro
 installing 12-12. *See also receiving faxes. See Chapter 12*
MF Link mode, turning on 12-15
phone book. *See On-Line Documentation*
printing
 driver 14-1
receiving faxes 16-5
 If you are having difficulty 22-7
 viewing faxes 16-6
scanning into PC
 accessing 17-7
 settings 17-8
 TWAIN compliant driver 17-6

- sending faxes
 - adding a cover page 16-4
 - attachment(s) 16-4
 - cover page only 16-3
 - If you are having difficulty 22-7
 - QuickFax 16-3
- uninstall 12-14
- multi-line connections (PBX) 2-13
- multi-purpose sheet feeder
 - capacity 2-5
 - loading paper 2-6

N

- NetCentric™ FaxStorm
 - customer support 18-2
- NTSC 11-1

O

- OCR 17-5
- On-Line Documentation 12-13, 12-14
- On-Screen Programming 3-1
- One Touch numbers
 - accessing with Shift key 7-1
 - changing 7-2
 - dialing 7-4
 - listing 9-1
 - storing 7-1
- optional accessories
 - memory 20-1
- overseas, sending faxes 6-10

P

- packing list 2-1
- paging, programming a number 8-1
- paper
 - loading 2-6
 - size 2-5
 - specifications S-1
- paper jam 22-4 to 22-6
- PaperPort® 17-3
 - exporting an image file 17-6
 - importing from other applications 17-6

- installing 12-11
- prescanning an image 17-10
- scanning into PC 17-7
 - accessing 17-7
 - settings 17-8
 - TWAIN compliant driver 17-6
- video capture to PC 17-12
 - capturing an image 17-12
 - connecting video equipment 17-12
- parallel interface cable 12-10
- pause 7-4
- PBX 2-13
- phone line difficulties 22-7
- Photo. *See resolution*
- polling
 - receiving 5-6
 - sending 6-12
 - sequential receiving 5-6
- power
 - cord 2-8
 - electrical outlet 2-8
 - failure 4-4
- Print Priority key 14-7
- printer, cleaning 22-18
- printer drivers, installing 12-4, 12-11, 12-12
 - iMac USB 23-1
- printer emulation 14-1
- printer jam 22-4, 22-5
- printing 14-1
 - density 5-4
 - difficulties 22-7 to 22-13
 - driver 14-1
 - envelopes. *See envelopes*
 - resolution S-2
 - speed S-2
 - two-sided (manual duplexing) 14-2
 - video capture. *See PaperPort®*
 - video printing. *See video printing (walk-up)*
- Windows® 14-1

Q

questions. *See FAQs i*

R

Real Time Transmission 6-6
receiving faxes. *See fax(es), stand-alone and Multi-Function Link® Pro*
redialing 6-5
reducing
 copies 10-4
 long faxes 5-3
remote printer console 14-1
remote retrieval 8-3
 access code
 changing 8-3
 using 8-3
 checking what's in memory 8-5
 commands 8-4
 getting your faxes 8-5
 Memory Status List 8-5
reports 9-1
 how to print 9-1
 list of last 50 faxes 9-2
 list of your stored numbers 9-1
 proof fax was sent 9-2
 types of 9-1
Reset key (clear printer memory) 14-7
resolution
 fax (Standard, Fine, Superfine, Photo) 6-4, S-1
 multiple 6-11
 printing S-2
 scanning
 iMac™/Macintosh® G3 23-2
 Windows® 17-8
 setting for next fax 6-4
ring volume 4-4
roll over phone lines 2-11

S

safety instructions 21-4
scanner, cleaning 22-17
Scanner drivers. *See drivers*
Scanner Lock 2-3, 22-14
scanning into PC 17-1 to 17-3. *See PaperPort® and PaperPort® and ScanSoft™ TextBridge*
 from Control Panel Keys 17-1
 Scan Image 17-1
 Scan to E-mail 17-2
 Scan/OCR 17-2
sending faxes, 16-3 to 16-4. *See also fax(es), stand-alone*
sending to Groups. *See Broadcasting setup*
 assembly. *See assembly of MFC*
 date and time 4-1
 Daylight Savings Time 4-5
 station ID (fax header) 4-2
shipping the MFC 22-14
simultaneous printing/faxing 14-6
Sleep Mode 4-4
software. *See also Multi-Function Link® Pro*
 for DOS users 13-1
 installing
 iMac™/Macintosh® G3 23-1
 Windows® Parallel 12-12
 Windows® USB 12-4
 using
 Brother Control Center 15-1
 Multi-Function Link® Pro 16-1
 ScanSoft™ PaperPort® 17-3
speaker volume 4-4
specifications S-1
Speed Dial
 changing 7-2
 dialing 7-4
 storing 7-2
Standard. *See resolution*
Station ID (fax header) 4-2
 Federal regulation 4-3
suggestions. *See troubleshooting*
Superfine. *See resolution*

T

- TAD (telephone answering device),
 - external
 - answer mode 5-1
 - connecting 2-9
 - recording outgoing message 2-10
 - telephone, external 2-9
 - telephone index (Tel-index) 7-4
- test
 - faxing 1-1
- text, entering 4-2
- timer 4-5
- toner cartridge
 - installing 2-4
 - replacing 22-19
- toner save 5-4
- Transmission Verification Report 9-2
- transparencies 2-7
- triplex adapter 2-11
- troubleshooting 22-1
 - document jam 22-4
 - error messages on LCD 22-1
 - if you are having difficulty 22-7
 - DOS setup printing 22-10
 - incoming calls 22-7
 - paper handling 22-11
 - phone line connections 22-7
 - printer difficulties 22-8
 - printing or receiving faxes 22-7
 - scanning difficulties 22-9
 - sending faxes 22-7
 - software difficulties 22-9
 - video capture 22-10
 - paper jam 22-4 to 22-6
- two-line phone system 2-11, 2-12
 - converting wall jacks 2-11

U

- User Settings 9-1

V

- video capture from PC
 - capturing an image 17-12
 - connecting to video equipment 17-12
 - difficulty 22-10
- video printing (walk-up) 11-1
 - changing default settings 11-3
 - print quality, setting 11-3
 - print size 11-4
 - setting up video print mode 11-2
 - video type, setting 11-4
- volume, setting
 - beeper 4-3
 - ring 4-4
 - speaker 4-4

W

- warranties
 - Canada vi
 - Notice of Disclaimer iii
 - USA iv
- Windows® 3.1x, 95/98, or NT® WS 4.0
 - (installing with your version)
 - 12-4 to 12-15, 12-12 to 12-15

Y

- Year 2000 Compliant. *See inside of front cover*

Remote Retrieval Access Card

If you plan to receive fax messages while away from your machine, carrying the Remote Retrieval Access Card printed below will serve as a convenient reminder of the retrieval procedures. Simply cut out the card and fold it to fit your wallet or organizer. Keeping it handy will help you derive the full benefit of your machine's forwarding, paging and remote retrieval features.

<p>Fold →</p>	<p>REMOTE RETRIEVAL ACCESS CARD</p> <hr/> <p>Using Remote Retrieval Access Code</p> <ol style="list-style-type: none">1 Dial your fax number from a fax machine using touch tone.2 When your MFC answers and beeps, immediately enter your Remote Retrieval Access Code (159✳).3 The MFC signals the kinds of messages received: 1 long beep — Fax message(s) No beeps — No messages.4 After 2 short beeps, enter a command.5 Press 9 0 to reset the MFC when you're finished.6 Hang up.	<p>← Fold</p>
<p>→ Fold</p>	<p>CHECK RECEIVING STATUS Press 9 7 1 1 long beep — Fax message(s) 3 short beeps — No messages</p> <p>CHANGE ANSWER MODE Press 9 8 <i>then for</i> EXT.TEL/TAD, press 1. FAX, press 2.</p> <p>EXIT REMOTE OPERATION Press 9 0.</p>	<p>← Fold</p>

Changing Remote Retrieval Access Code

- 1 Press **[Function]**, **[1]**, **[7]**, **[3]**.
- 2 Enter a three-digit number from 000 to 999. The * cannot be changed.
- 3 Press **[Set]**.
- 4 Press **[Stop]** to exit.

Remote Commands

CHANGE PAGING/FAX FORWARDING SETTING

- Press **[9]** **[5]**
then to Turn Feature off, press **[1]**.
Select Fax Forwarding, press **[2]**.
Select Paging, press **[3]**.

Program Fax Forwarding Number press **[4]**. Enter the new telephone number of the remote fax machine where you want your fax message forwarded, and then press **[#]** **[#]**.

To retrieve a Memory Status List to check the new number, after two short beeps press **[9]** **[6]** **[1]**. Enter the number of the remote fax machine, and press **[#]** **[#]**.

Turn Fax Storage on, press **[6]**.
Turn Fax Storage off, press **[7]**.

RETRIEVE A FAX

Press **[9]** **[6]**
then to

Print a Memory Status List, press **[1]**, then enter the number of the remote fax machine, and press **[#]** **[#]**. After the beep, hang up and wait.

Retrieve all faxes, press **[2]**.

then enter the number of the remote fax machine, and press **[#]** **[#]**. After the beep, hang up and wait.

Erase all fax messages, press **[3]**.

Fold →

← Fold

brother®

At your side.

Brother International Corporation
100 Somerset Corporate Boulevard
P.O. Box 6911
Bridgewater, NJ 08807-0911 USA

Brother International Corporation (Canada) Ltd.
1 rue Hôtel de Ville,
Dollard-des-Ormeaux, QC, CANADA H9B 3H6

**Visit us on the World Wide Web
<http://www.brother.com>**

These machines are made for use in the USA and CANADA only. We cannot recommend using them overseas because it may violate the Telecommunications Regulations of that country and the power requirements of your Multi-Function Center may not be compatible with the power available in foreign countries. **Using USA or CANADA models overseas is at your own risk and will void your warranty.**