

brother®

Upgrade KIT III Operation Manual

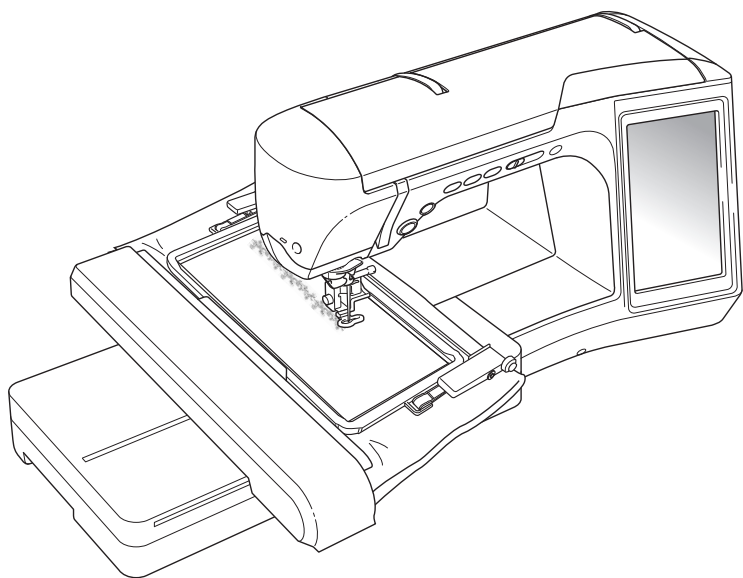

CONTENTS

BEFORE YOU START.....	2
NEW FEATURES.....	2
EMBROIDERING WITH THE BORDER EMBROIDERY FRAME (30 cm x 10 cm (approx. 11-3/4 inches x 4 inches)).....	3
About the Border Embroidery Frame.....	3
Sample Projects Using the Border Embroidery Frame	3
Selecting a Pattern.....	4
Hooping the Fabric in the Border Embroidery Frame.....	6
Attaching the Border Embroidery Frame to the Embroidery Unit.....	7
Embroidering the First Pattern.....	8
Removing the Border Embroidery Frame	9
Embroidering the Next Pattern.....	9
USING THE CAMERA TO CONNECT PATTERNS	12
Connecting Patterns.....	12
Preparation (Camera Needle Position Setting).....	13
Practice (Connecting Three Patterns)	14
CHANGING THE POSITION OF A STICKER	22
CONNECTING ROTATED PATTERNS.....	27
CHANGING THE REFERENCE EDGE AND REFERENCE POINT FOR CONNECTING THE NEXT PATTERN AFTER A PATTERN HAS BEEN EMBROIDERED	29
SLIDING THE POSITION OF THE PATTERN TO BE CONNECTED	32
Connecting Patterns to be Joined Along an Edge.....	33
TROUBLESHOOTING.....	36
Resume Feature.....	37
NEW FEATURES OF VERSION 2 (For NV1/NV6000D customer only).....	38
Displaying Patterns in The Embroidery Edit Screen Magnified By 200%	38
Specifying The Size of Pattern Thumbnails	38
Saving a Camera Image or Settings Screen Image to USB Media.....	39
Displaying The Grid.....	40
Other New Features	41
New Patterns for Version 2	44
COLOR CHANGE TABLE FOR THE EMBROIDERY PATTERNS ON THE CD-ROM	45

BEFORE YOU START

It is important to perform the upgrade according to the procedure described in the Installation Guide. The machine can then be used as described in the Operation Manual. The border embroidery frame (30 cm × 10 cm (approx. 11-3/4 inches × 4 inches)) will show on the LCD screen of the machine and the frame will be recognized when attached to the embroidery frame holder. New machine features and benefits are described in this guide.

NEW FEATURES

- A border embroidery frame (30 cm × 10 cm (approx. 11-3/4 inches × 4 inches)) is included, allowing the fabric to easily be rehooped when embroidering repeated patterns.
- Instead of using a thread mark, the built-in camera can be used to connect embroidery patterns. (Embroidery Edit)
- Ten embroidery designs created to show the convenience and potential of the border embroidery frame are available on the included CD. To view a list of the patterns, refer to page 45.

EMBROIDERING WITH THE BORDER EMBROIDERY FRAME (30 cm × 10 cm (approx. 11-3/4 inches × 4 inches))

About the Border Embroidery Frame

Since the fabric can easily be repositioned and rehooped when the border embroidery frame is used, this frame is useful for embroidering repeated patterns while sliding the fabric. An added feature of this frame is that the pressure applied by the upper and lower frames will not leave an indentation in the fabric. An area of 30 cm × 10 cm (approx. 11-3/4 inches × 4 inches) can be embroidered.

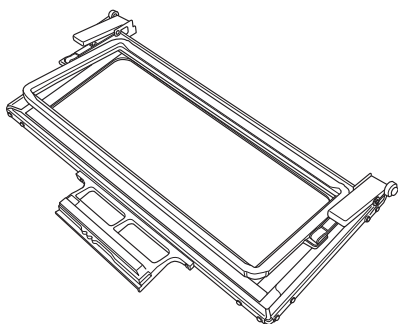

CAUTION

- Do not leave the border embroidery frame within the reach of children, otherwise injuries may result.

Note



- When the border embroidery frame is not being used, unlock it before storing it.
- Due to its construction, the border embroidery frame does not hold fabric as tightly as other frames. Since fabric shrinkage may occur, depending on the fabric and pattern used, be sure to sew trial embroidery on a piece of scrap fabric before sewing your project.

Sample Projects Using the Border Embroidery Frame

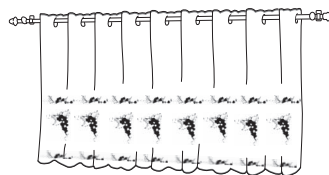
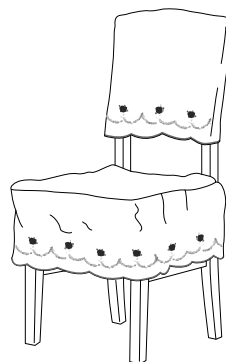
We recommend using the border embroidery frame when repeated patterns are embroidered at the edges of items such as curtains, chair covers, bed covers, tablecloths and blankets.





Selecting a Pattern

- 1 Press .
- 2 On page 6/8 for the embroidery frame display settings, select one of the embroidery frame displays for the border embroidery frame (30 cm × 10 cm (approx. 11-3/4 inches × 4 inches)). Press  to return to the previous screen.

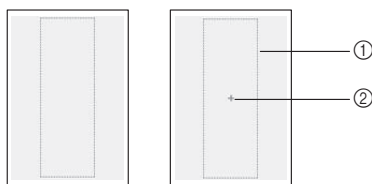
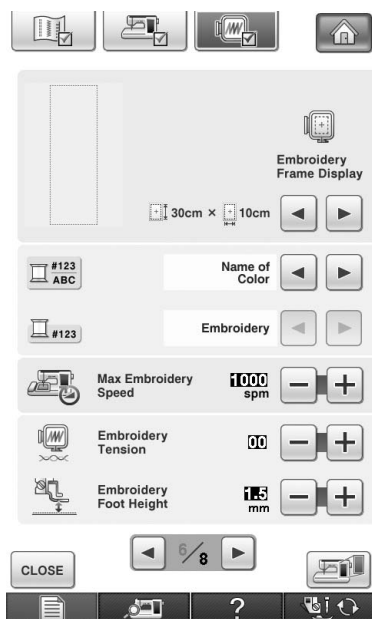
* Of the 16 settings available, there are 2 for border embroidery frames (30 cm × 10 cm (approx. 11-3/4 inches × 4 inches)).



- 1 Border embroidery frame embroidering area (30 cm × 10 cm (approx. 11-3/4 inches × 4 inches))
- 2 Center mark

- 3 Press  and select a pattern, and then press .
- 4 Use the border function to repeat the pattern.

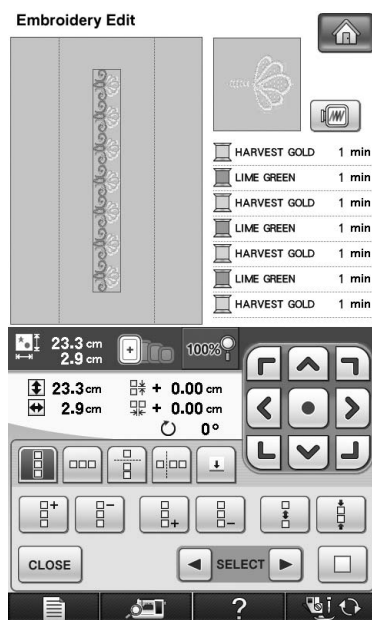

Memo

- For details for the border function, refer to "Designing Repeated Patterns" in chapter 6 of the Operation Manual for the sewing machine.

- 5 If necessary, assign thread marks. Since the pattern will be repeatedly embroidered from the top to the bottom, add the thread mark to the lower center of the bottom pattern. When you are finished, press **CLOSE**.

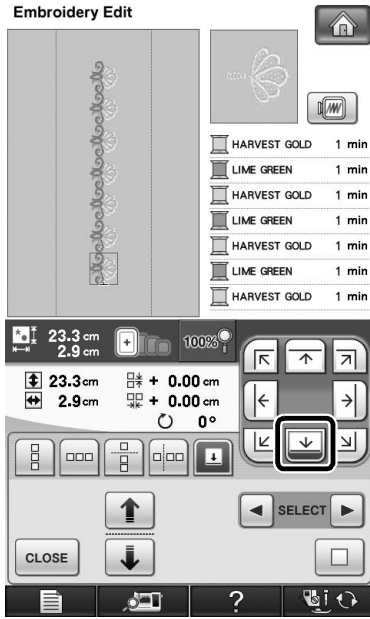

→ Touch **↑** and **↓**, or **←** and **→** to highlight the design for inserting thread marks.

Note

- Do not add thread marks to character patterns.
- Add thread marks to patterns that do not have a point of alignment, such as rotated patterns or patterns that are spaced apart. Patterns that can be aligned visually can be embroidered cleanly without the thread mark.

Memo

- Select the location where the thread mark is to be added according to the direction that the embroidery is repeated.

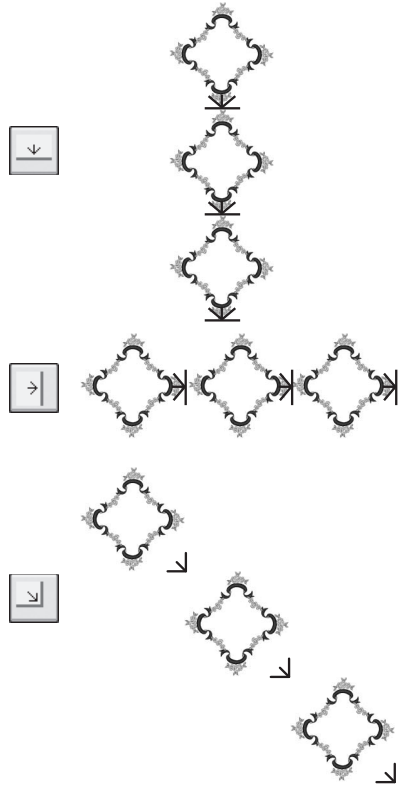

If the design direction is rotated, use the following suggestions.

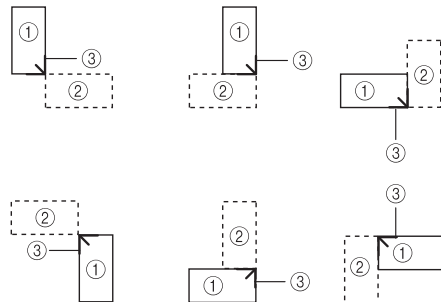

- ① First Pattern
- ② Second Pattern
- ③ Thread mark

6 Press **SEWING**.

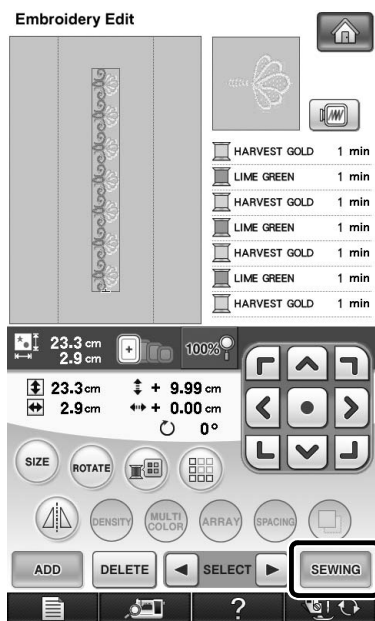

Hooping the Fabric in the Border Embroidery Frame

- 1 With a chalk pen, mark the fabric with a line drawn down the center of the area to be embroidered.

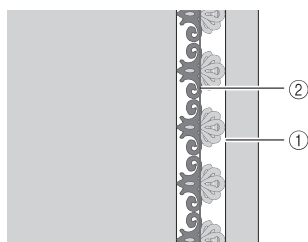

- 1 Pattern
- 2 Center mark (line)

- 2 Affix stabilizer material to the fabric to be embroidered.



Note

- When embroidering the edges of the fabric, affix stabilizer material larger than the fabric, and then firmly secure the fabric and excess part of the stabilizer material within the border embroidery frame (in the same way as when the normal embroidery frame is used). Otherwise, misaligned patterns may result.

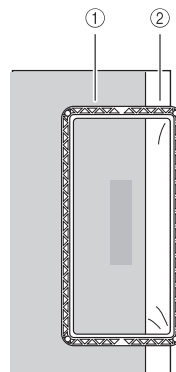

- 1 Fabric
- 2 Stabilizer

- 3 If the upper frame is locked down against the lower frame, press the left and right lock release buttons to unlock the upper frame.

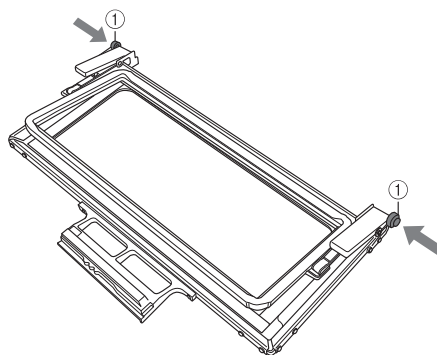

- 1 Lock release buttons

- 4 Lay the fabric between the upper and lower frames.

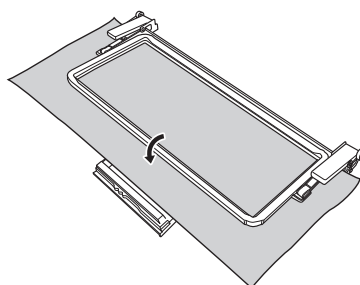

- 5 Place the embroidery sheet in the upper frame, align the guide line on the embroidery sheet with the center mark (line) on the fabric, and then press down on the left and right locking levers until they click into place.

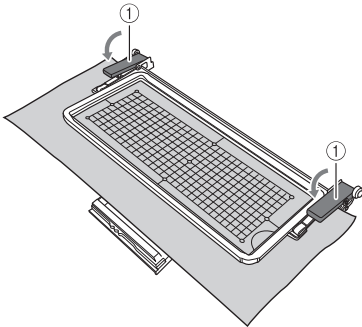

① Locking levers



Memo

- The fabric can also be positioned in the border embroidery frame by aligning the edge of the fabric with the inner markings on the upper frame.

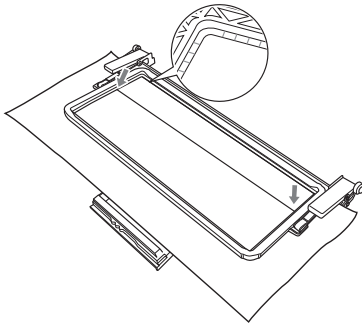

Note

- If there is excess fabric after the center of the embroidering area is aligned with the center of the border embroidery frame, fold over the excess fabric, place it on top of the upper frame, and then press down on the levers. Be careful that the folded excess fabric is not caught in the embroidering area.

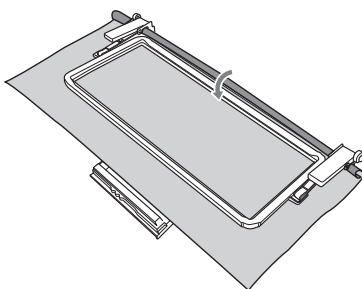

- 6 Remove the embroidery sheet, and then gently pull the four sides of the fabric to remove any excess slack. Be careful so that fabric is not stretched out of shape. Finally, check that the fabric is firmly within the hoop.

Attaching the Border Embroidery Frame to the Embroidery Unit

CAUTION

- After firmly hooping the fabric in the border embroidery frame, attach the frame to the embroidery unit. Otherwise, the needle may break and cause injuries.
- Before attaching the border embroidery frame to the embroidery unit, make sure that the needle and presser foot have been raised. Otherwise, the needle may break and cause injuries.



Note

- Before attaching the border embroidery frame, wind the bobbin with thread and install it.

- 1 Make sure that the needle and presser foot have been raised. If the needle has not been raised, press the "Needle Position" button to raise it. If the presser foot has not been raised, press the "Presser Foot Lifter" button to raise it.
- 2 Make sure that the embroidery unit carriage has moved to its initial position.
- 3 Align the guide on the border embroidery frame with the right edge of the embroidery frame holder.

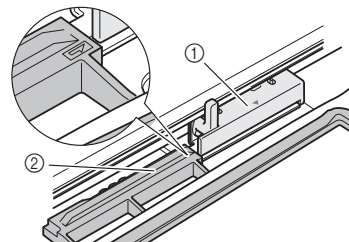

- ① Embroidery frame holder
② Guide on border embroidery frame

- 4 Slide the border embroidery frame into the embroidery frame holder, making sure to align the border embroidery frame's arrow mark (△) with the embroidery frame holder's arrow mark (△).

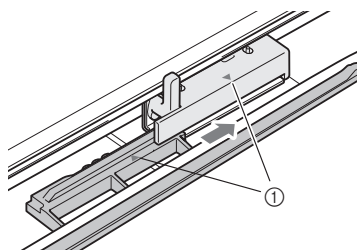

① Arrow marks

- 5 Lower the frame-securing lever so that it is level with the border embroidery frame to secure the border embroidery frame to the embroidery frame holder.

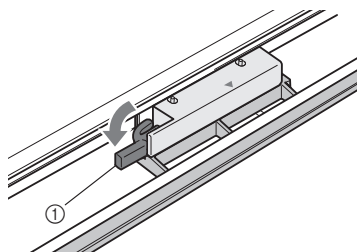

① Frame-securing lever

⚠ CAUTION

- If the frame-securing lever is not lowered, the pattern may not embroider correctly or the presser foot may strike the border embroidery frame and cause injuries.

Embroidering the First Pattern

Note

- When the border embroidery frame is used, the embroidering time may vary slightly than the time that appears in the screen, depending on the type of fabric and pattern that is used.

- 1 To check the embroidering area, press .

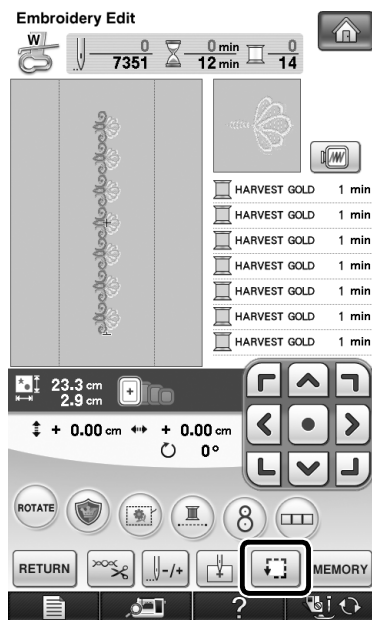

- 2 Thread the machine, and then start embroidering.

⚠ CAUTION

- Do not touch the border embroidery frame while embroidering.

→ When embroidering is finished, the thread mark is sewn with the last thread color.

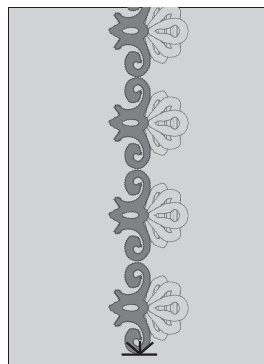

Removing the Border Embroidery Frame

Note

- Before removing the border embroidery frame from the embroidery unit, make sure that the embroidery unit carriage has moved to its initial position.

- 1 Raise the frame-securing lever and pull the border embroidery frame toward you.

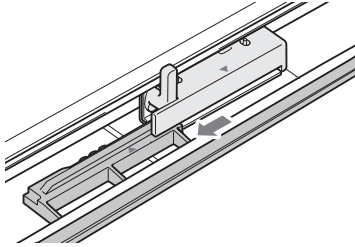

CAUTION

- If the thread has become tangled and the embroidery unit carriage does not move to its initial position, even after the thread is cut, turn off the machine, manually gently move the carriage, and then remove the border embroidery frame.
- Only move the embroidery unit carriage when the machine is turned off.

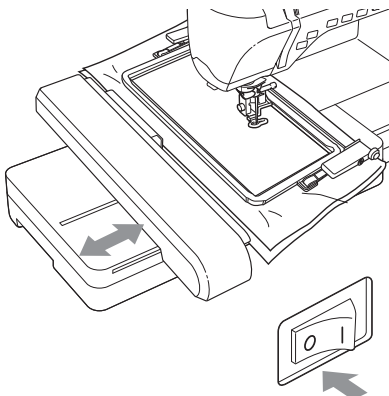

Embroidering the Next Pattern

- 1 Press both lock release buttons and slide the fabric to align the embroidering area of the next pattern, and rehoop the fabric in the border embroidery frame.

Note

- Adjust the position of the fabric so that the embroidering area for the next pattern is within the embroidering area of the embroidery sheet.

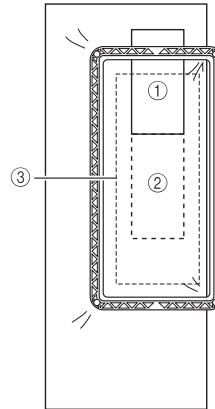

- ① Pattern embroidered first
- ② Position of pattern to be embroidered next
- ③ Embroidering area of embroidery sheet

- 2 Attach the border embroidery frame to the embroidery unit, and then press .

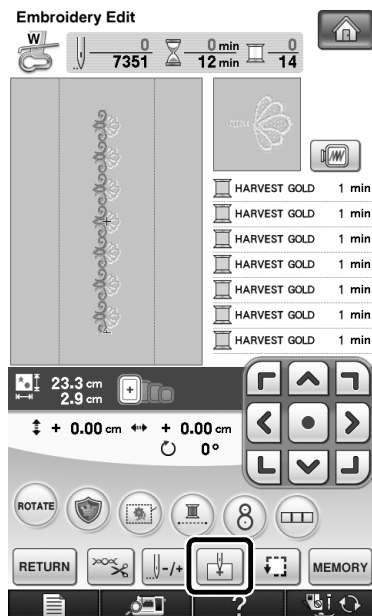

- 3 Use  to select the needle position that will align with the thread mark at the end of previous embroidery. For this example, align the needle position with the upper center of the next pattern. When you are finished, press



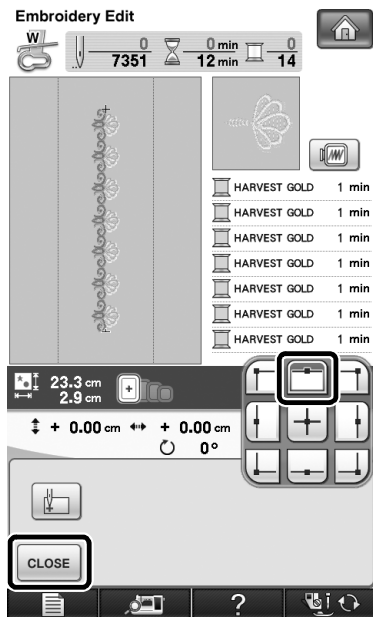

- 4 Use  to align the needle position with the point of the thread mark.

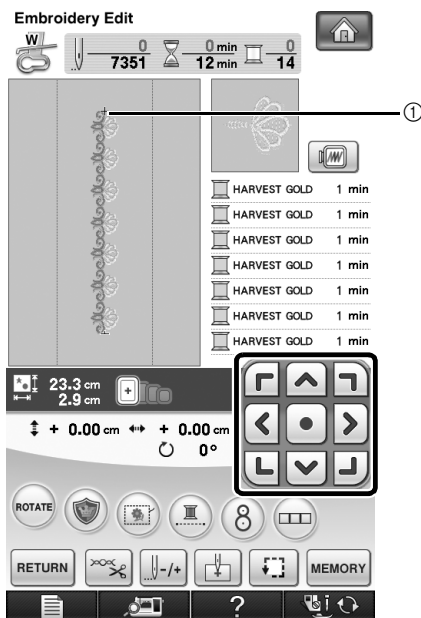
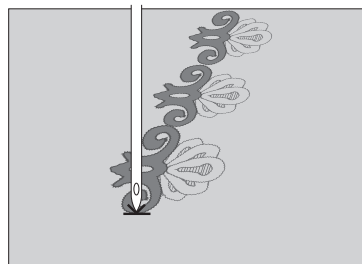

① Needle position

 **Note**

- After turning the handwheel to check the needle position, press the “Needle Position” button to raise the needle.

- 5 After aligning the needle position for the beginning of embroidering, remove the thread mark.

 **Note**

- Remove the thread mark before starting to embroider. Otherwise, the thread mark stitching may be combined with the pattern stitching and become difficult to remove.

- 6 Embroider the next pattern. To continue embroidering a repeating pattern, repeat the procedure starting with “Removing the Border Embroidery Frame”.

 **CAUTION**

- If the sewing machine is turned off, then turned on again with the border embroidery frame attached or if you try to select a stitch from the Utility Stitch screen or the Character/Decorative Stitch screen while the border embroidery frame is attached, the following message appears. If the border embroidery frame is not fully removed from the embroidery unit at this time, the border embroidery frame may be hit by the presser foot when the carriage of the embroidery unit is moved. When the following message appears, fully remove the border embroidery frame.

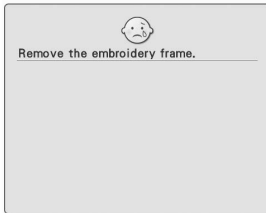

USING THE CAMERA TO CONNECT PATTERNS

Instead of using thread marks, the camera can be used to connect patterns in the Embroidery Edit screen. An area of 27 cm × 17 cm (10-1/2 inches × 6-1/2 inches) can be embroidered when the camera is used to connect patterns. Select the appropriate frame depending on the size of the embroidery. We recommend using the large embroidery frame (30 cm × 20 cm (12 inches × 8 inches)) when using the camera to connect patterns. The small embroidery frame (2 cm × 6 cm (1 inch × 2-1/2 inches)) cannot be used with the camera function.



Note

- Split (Large-size) embroidery patterns cannot be used with this function.

Connecting Patterns

Two patterns can be connected by selecting the reference point and reference edge of each pattern so that they can be aligned using the camera. When connecting patterns, the reference edge of each pattern will be along a single straight line.

(Example)

- : Reference edge
○ : Reference point

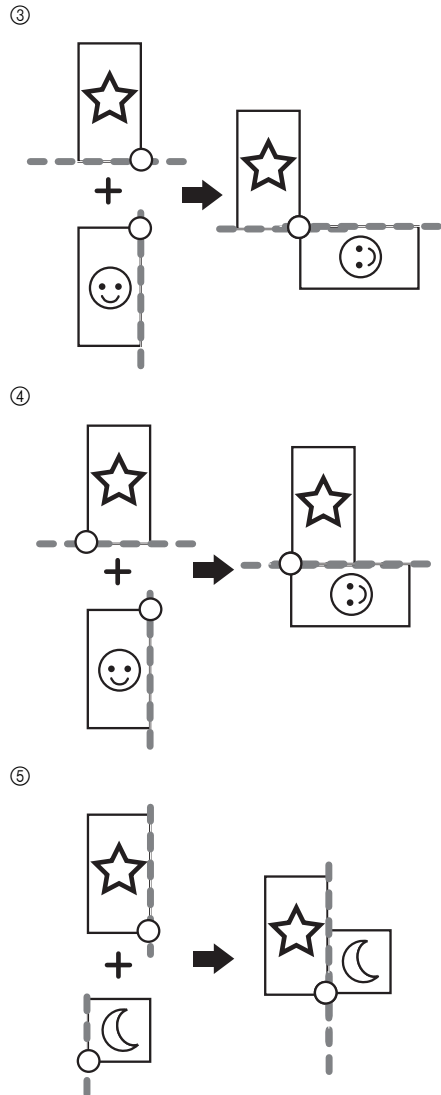
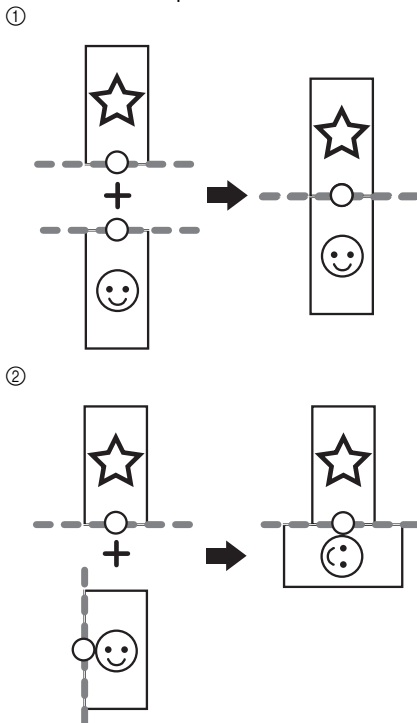

In order to understand how to connect patterns, first try following the procedure outlined in "Practice (Connecting Three Patterns)" on page 14.

Preparation (Camera Needle Position Setting)

When connecting patterns by using the camera, set the camera needle position. This operation is essential when you use this function for the first time. It is not necessary to perform this operation each time, but we recommend performing it when the needle is changed. Use the white stickers (solid) included with this Kit.

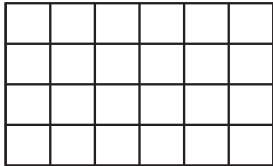

- 1 Prepare the needle to be used to connect patterns.
- 2 Hold your finger on the screen, and then turn on the machine.



Note

- Be careful not to touch the LCD screen prior to Step 3 below.
- This function can be performed with or without embroidery unit attached to machine. If attached, message screens will appear regarding movement of embroidery unit.

- 3 Press the "Automatic Threading" button.

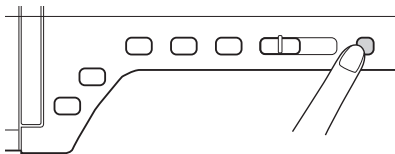

→ Camera needle position setting screen appears.

Camera Needle Position Setting Mode

1. Raise needle bar to its highest position.
2. Remove presser foot and replace needle with a new embroidery needle standard size 75/11 or 90/14.
3. Affix white sticker on needle dropping point area.
4. Press START key to initiate the calibration process. For safety please make sure area around needle is clear prior to pressing "START" key.

If necessary, please refer to instruction manual and reference guide for recommended needle.

START

- 4 Follow the on-screen instructions to complete the procedure.

1. Raise needle bar to its highest position.

Note

- The "Needle Position" button cannot be used while setting the camera needle position. Turn the handwheel to move the needle bar.

2. Remove presser foot and replace needle with a new embroidery needle standard size 75/11 or 90/14.
3. Affix white sticker on needle dropping point area.

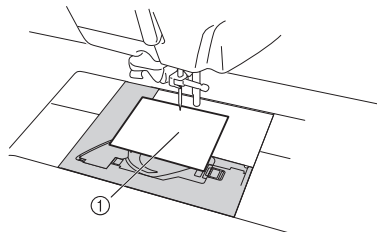

- ① White sticker

Note

- Use a new sticker. The camera needle position cannot be set correctly if there is a hole in sticker or if it is dirty. If you have no new stickers, contact your nearest Brother dealer.

4. Press **START** to initiate the calibration process. For safety please make sure area around needle is clear prior to pressing

START

→ Setting the needle drop point begins.

- 5 The operation is finished when "OK" appears. If "NG" appears, remove the sticker, and then follow the on-screen instructions to repeat steps 3 and 4 of Step 4. If multiple attempts to set the position are not successful, contact your nearest Brother dealer.

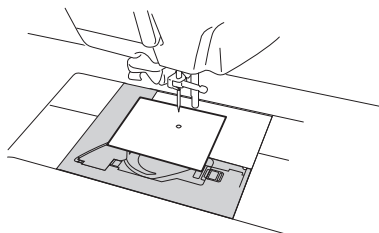

Camera Needle Position Setting Mode

- 1.Raise needle bar to its highest position.
- 2.Remove presser foot and replace needle with a new embroidery needle standard size 75/11 or 90/14.
- 3.Affix white sticker on needle dropping point area.
- 4.Press START key to initiate the calibration process. For safety please make sure area around needle is clear prior to pressing "START" key.

OK.

- 6 Remove the sticker, and then turn off the machine.

Note



- When using the camera to connect patterns, use the needle that was installed when the camera needle position was set.

Practice (Connecting Three Patterns)

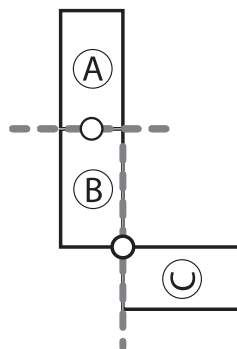
In order to practice aligning pattern edges by using the camera, we will connect three patterns as shown below.



- A : First pattern
B : Second pattern
C : Third pattern

- 1 Press  in the Embroidery Edit screen, select the pattern shown below, and then press .

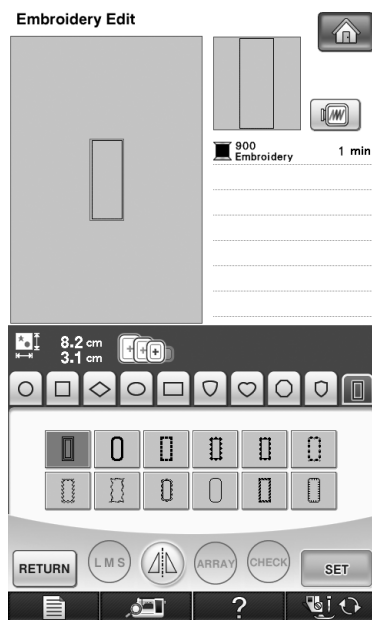

- 2 Thread the machine with the upper thread and the bobbin thread.

- 3 Hoop fabric in the 20 cm × 20 cm (8 inches × 8 inches) embroidery frame, and then attach the frame to the embroidery machine.

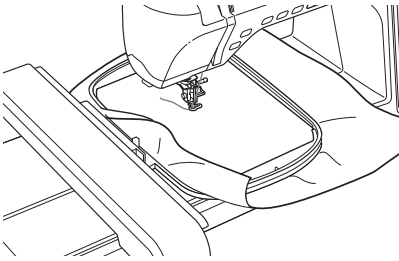

- 4 Press **SEWING** to display the sewing screen.

- 5 Press  in the sewing screen.

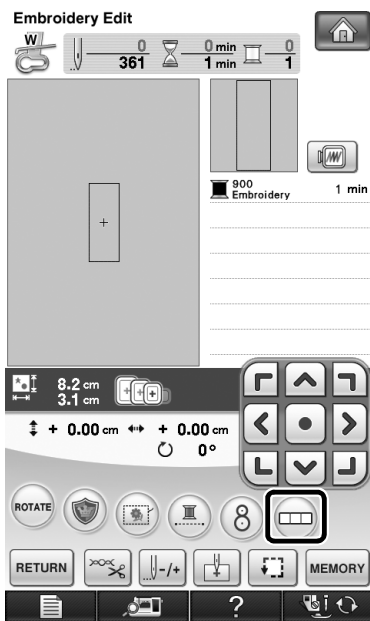

→ The pattern connection setting screen (screen for connecting the selected pattern to the next one) appears.

Memo



- A pattern cannot be saved in the machine's memory while patterns are being connected.

- 6 Select the reference edge and reference point of the selected pattern for connecting the next pattern. Since, in this example, we will connect the center point of the bottom edge for the first pattern with the center point of the top edge for the next pattern, select the center point of the bottom edge, and then press **CLOSE**.

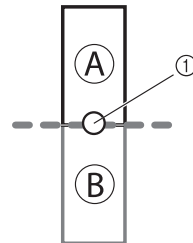
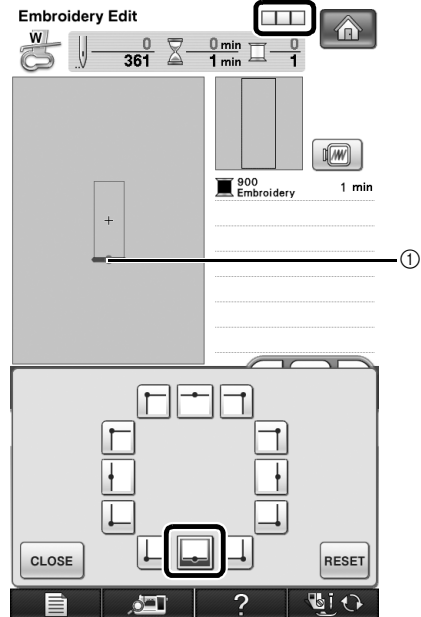
- To cancel the selection, press **RESET**.



- ① Reference edge and reference point of first pattern

→  appears in the screen, and then  changes to .

- 7 Lower the presser foot, and then embroider the first pattern.

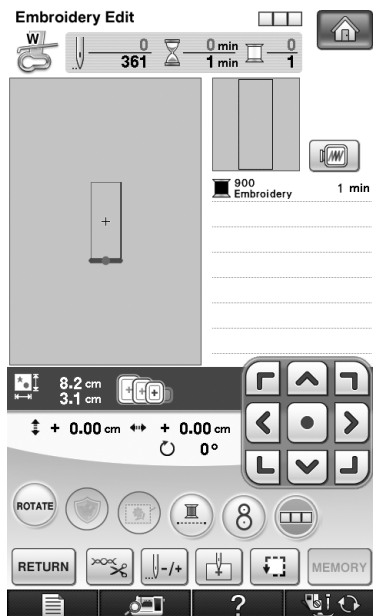

- 8 When the following message appears, press

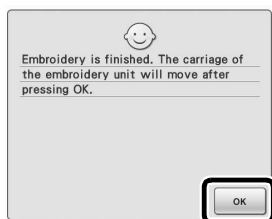

→ The carriage will move.

- 9 Prepare two embroidery positioning stickers. We will follow the on-screen instructions to affix these two stickers to the fabric so that the positioning marks can be detected by the camera.

Note

- Use the positioning stickers included with this product or purchase replacement stickers (SAEPS2, EPS2: XF0763-001) from your Brother dealer. If any other sticker is used, the camera may not recognize it.
- The 182 mm × 257 mm (7 inches × 10 inches) embroidery positioning sticker sheet with strong adhesion is most appropriate for connecting patterns (SAEPS2, EPS2: XF0763-001). If any other positioning sticker is used, it may peel off. If the sticker peels off, the patterns cannot be connected.

- 10 Affix the first embroidery positioning sticker onto the fabric within the red lines by using both hands to press down on each corner of the sticker. Affix the sticker with the large circle to the top as shown on machine. Then, press

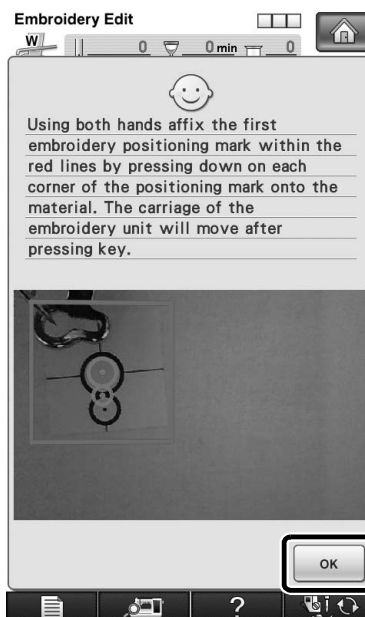

→ The camera detects the first positioning sticker.

Note

- Use new positioning stickers. If a sticker is reused, it may easily peel off. If the sticker peels off during this procedure, the patterns cannot be connected.
- Using fingers apply pressure to the corners of the positioning sticker to firmly affix it to the fabric. If the sticker is not firmly attached, the camera may incorrectly detect the sticker.
- If any of the following messages appear, reattach the positioning sticker in the correct position. Make sure that the sticker is affixed with the large circle at the top.

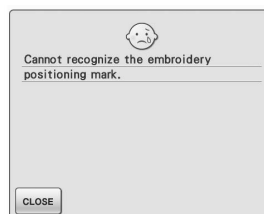

- 11 Using both hands affix the second embroidery positioning mark within the red lines by pressing down on each corner of the positioning mark onto the material and then touch .

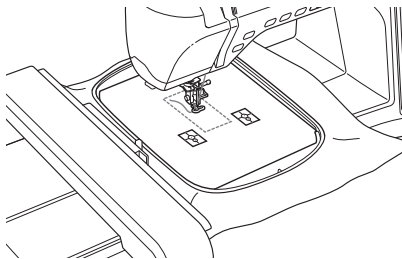
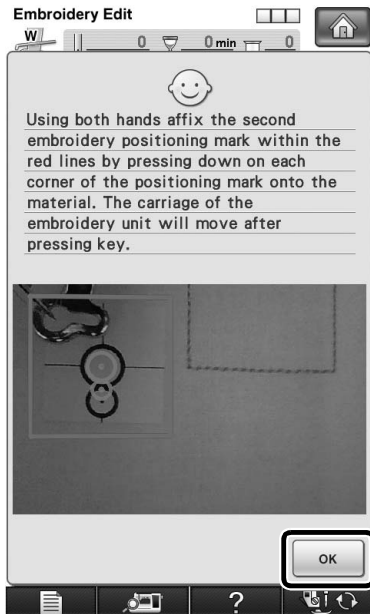

→ The camera detects the second positioning sticker.

- 12 After the two positioning stickers have been detected, the following message appears. With the stickers remaining attached, remove the frame, and then press .

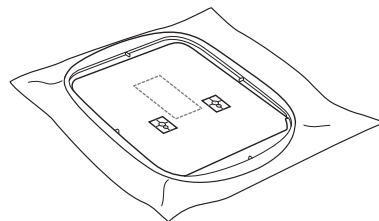
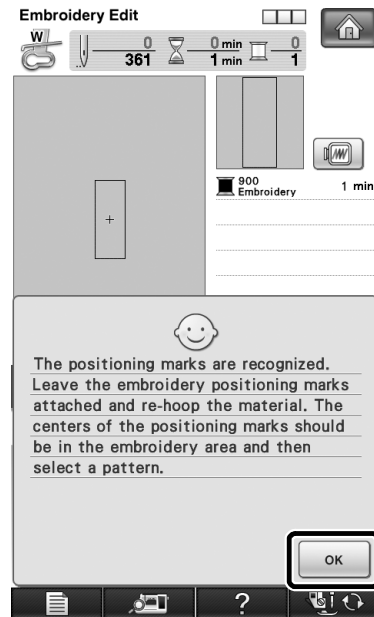

- 13 While making sure that the positioning stickers do not peel off, rehoop the fabric so that the next pattern and the centers of the large circles of the two stickers are within the embroidering area. Check with the embroidery sheet. After checking, reattach the embroidery frame to the machine.

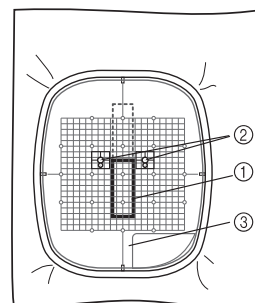

- ① Pattern to be embroidered next
- ② Centers of large circles for stickers
- ③ Embroidery sheet

Note

- If the next pattern and the centers of the large circles of the two positioning stickers do not fit within the embroidering area, use a larger embroidery frame. If a larger embroidery frame cannot be used, continue to step 15, and then refer to "CHANGING THE POSITION OF A STICKER" on page 22 to reposition the sticker.
- If the sticker peels off during this procedure, the patterns cannot be connected. In that case, restart the procedure from the beginning.

14 Select the second pattern, and then continue to the sewing screen. For this example, select the same pattern as the first one.

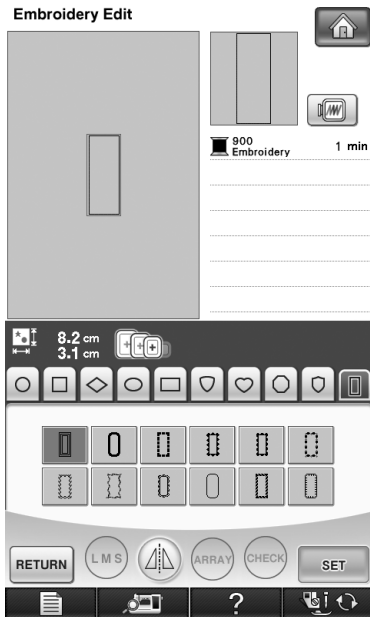

15 When the pattern connection setting screen (screen for connecting the selected pattern to the previous one) appears, select the reference edge and reference point for connecting the first pattern, and then press **OK**. Since, in this example, we will connect the center point of the top edge for the second pattern with the center point of the bottom edge for the first pattern, select the center point of the top edge, and then press **OK**.

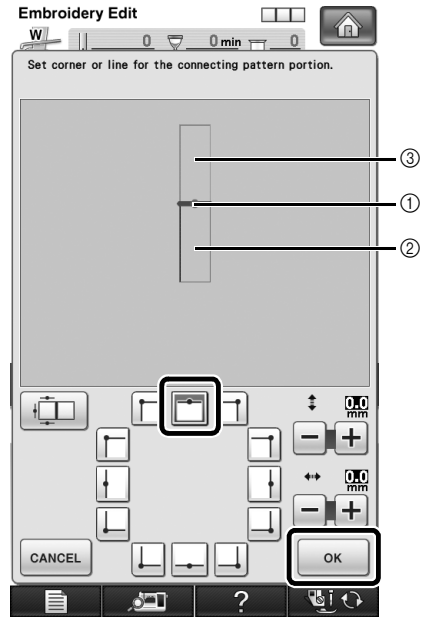
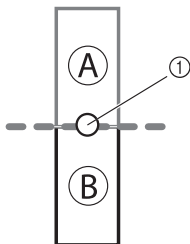

- ① Reference edge and reference point
- ② Second pattern (B)
- ③ First pattern (A)

Note

- In this screen, the reference edge and reference point of the first pattern can be changed. For details, refer to "CHANGING THE REFERENCE EDGE AND REFERENCE POINT FOR CONNECTING THE NEXT PATTERN AFTER A PATTERN HAS BEEN EMBROIDERED" on page 29.
- If the positioning stickers do not fit within the embroidering area, refer to "CHANGING THE POSITION OF A STICKER" on page 22 to reposition the sticker.
- Using **+** and **-** in this screen, the position of the second pattern can be changed. For details, refer to "SLIDING THE POSITION OF THE PATTERN TO BE CONNECTED" on page 32.

16 Select the area containing one of the two stickers, and then press **SCAN**.

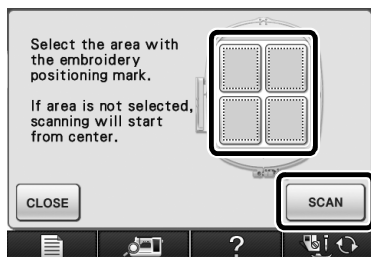

→ The camera detects the two marks.

Note

- To return to the sewing screen, press **CLOSE**.

Pressing **RETURN**, then **SEWING** displays the pattern connection setting screen (screen for connecting the selected pattern to the previous one), where the reference edge and reference point can be selected.

- If the following message appears, press **CLOSE**, and then rehoop the fabric so that the centers of the large circles of the positioning stickers are within the embroidering area or hoop the fabric in a larger embroidery frame. After checking that the area containing one of the two stickers have been correctly selected in step **16**, press **SCAN**.

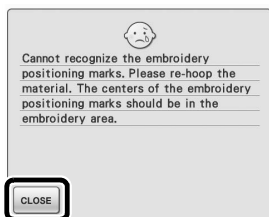

The message above also appears when the positioning sticker is too closely attached to the perimeters of the embroidering area. In that case, rehoop the fabric so that the stickers fit more within the embroidering area.

- If the following message appears, press **CLOSE**, and then rehoop the fabric so that the pattern and the centers of the large circles of the positioning stickers are within the embroidering area or hoop the fabric in a larger embroidery frame.

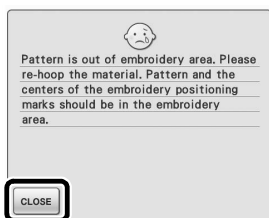

If the positioning stickers do not fit within the embroidering area, press **CLOSE** in the screen shown below.

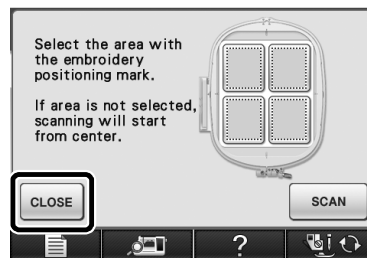

Next, press **RETURN**, then **SEWING** to display the pattern connection setting screen.

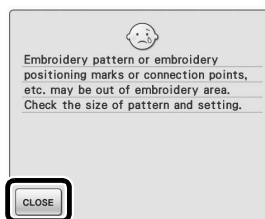

Refer to "CHANGING THE POSITION OF A STICKER" on page 22 to reposition the sticker.

- If the following message appears, press **CLOSE** to return to the pattern editing screen. Check the pattern size and pattern connection settings, and then repeat the previous steps.

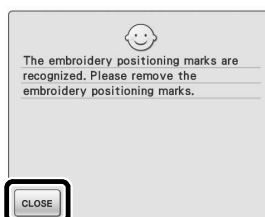

17 After the positioning stickers have been detected, press **CLOSE**, and then remove the stickers.



- 18 Before embroidering, press  to display the pattern connection setting screen (screen for connecting the selected pattern to the next one) appears. Select the reference edge and reference point for connecting the second and third patterns, and then press . In this example, we will select the bottom point of the right edge.

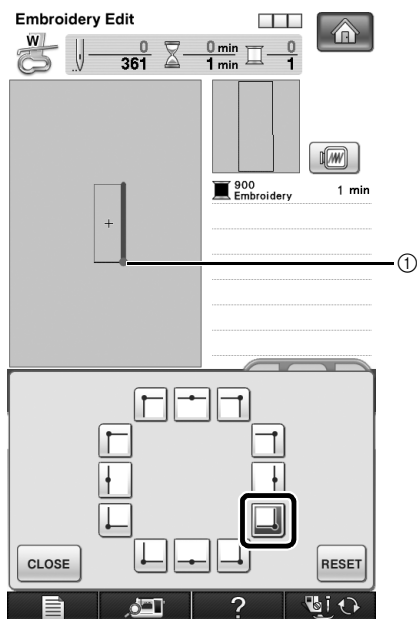
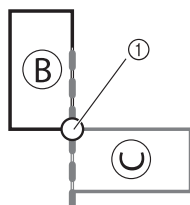

① Reference edge and reference point



Note

- Before embroidering, select the reference edge and reference point of the selected pattern for connecting the next pattern. Once the pattern has been embroidered, refer to "TROUBLESHOOTING" on page 36.

- 19 Lower the presser foot, and then embroider the second pattern.

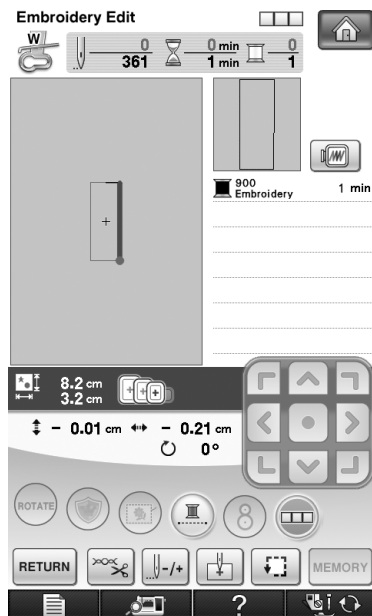

Note

- If the machine is stopped and  is pressed while embroidering or after embroidering has begun, the reference edge and reference point for connecting the next pattern can be set.

- 20 Follow the on-screen instructions to perform steps 8 through 12.
- 21 While making sure that the positioning stickers do not peel off, rehoop the fabric so that the next pattern and the centers of the large circles of the two stickers are within the embroidering area. Check with the embroidery sheet. After checking, attach the embroidery frame to the machine.

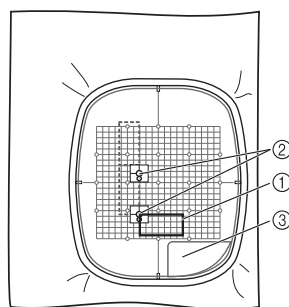

- ① Pattern to be embroidered next
- ② Centers of large circles for stickers
- ③ Embroidery sheet

22 Select the third pattern, and then continue to the sewing screen. For this example, select the same pattern as the first and second ones.

23 When the pattern connection setting screen (screen for connecting the selected pattern to the previous one) appears, select the reference edge and reference point for connecting the third pattern with the second one, and then press **OK**. Since, in this example, we will connect the right point of the top edge for the third pattern with the bottom point of the right edge for the second pattern, select the right point of the top edge, and then press **OK**.

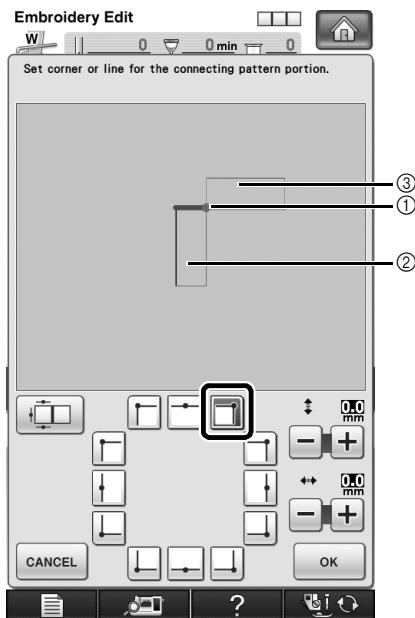
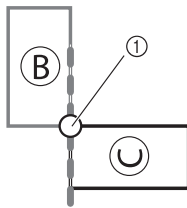



- ① Reference edge and reference point
- ② Third pattern (C)
- ③ Second pattern (B)

24 Perform steps 16 and 17.

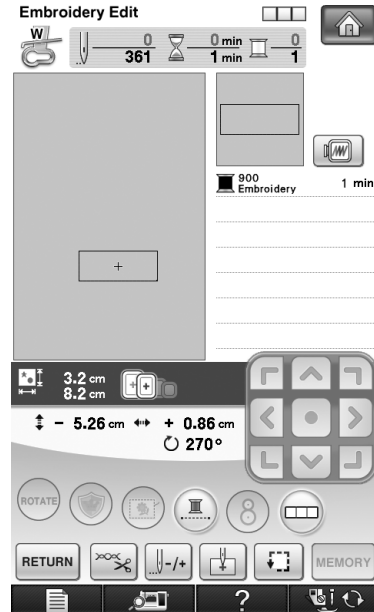

25 Lower the presser foot, and then embroider the third pattern.



→ After embroidering is finished,  is no longer highlighted.

The three patterns have been connected.



Press  to clear the pattern.

CHANGING THE POSITION OF A STICKER

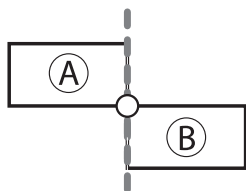
While using the camera to connect patterns, a sticker can be repositioned if the fabric cannot be rehooped so that the next pattern and the centers of the large circles of the two stickers are within the embroidering area. As an example, we will use the embroidery frame with a size of 10 cm × 10 cm (4 inches × 4 inches) to connect patterns as shown below.



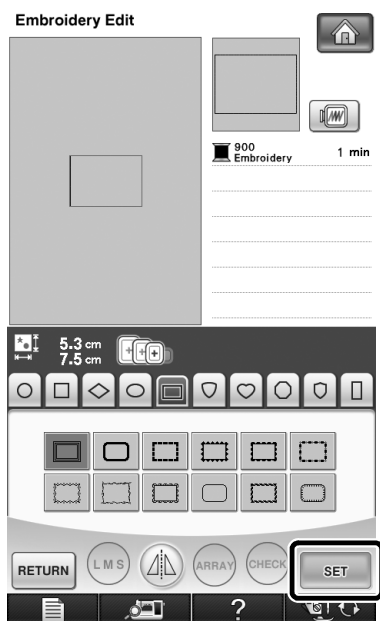

A: First pattern
B: Second pattern

- 1 Press  (frame patterns) in the Embroidery Edit screen, select the pattern shown below, and then press .

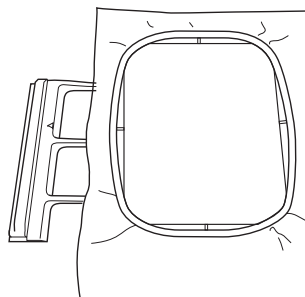

- 2 Thread the machine with the upper thread and the bobbin thread.
- 3 Hoop fabric in the embroidery frame with a size of 10 cm × 10 cm (4 inches × 4 inches), and then attach the frame to the embroidery machine.



- 4 Press  to display the sewing screen.
- 5 Press  in the sewing screen.

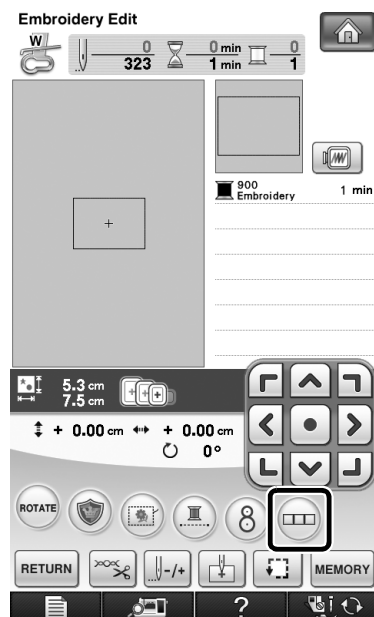

→ The pattern connection setting screen (screen for connecting the selected pattern to the next one) appears.

- 6 Select the reference edge and reference point for connecting this pattern to the next one, and then press **CLOSE**. For this example, select the bottom point of the right edge.

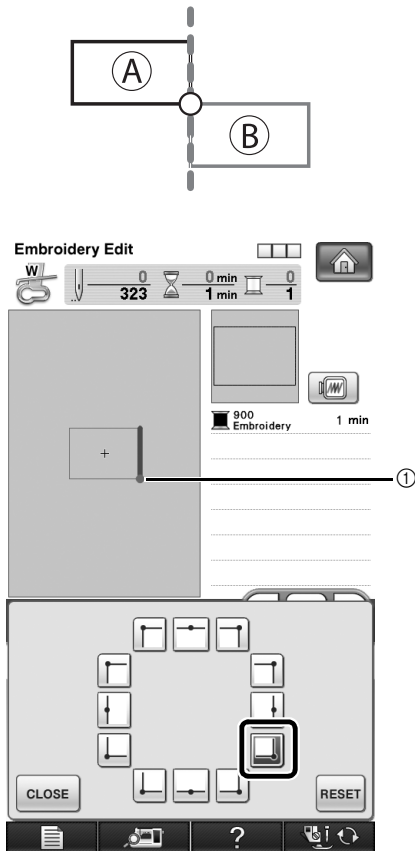

① Reference edge and reference point

- 7 Lower the presser foot, and then embroider the first pattern.

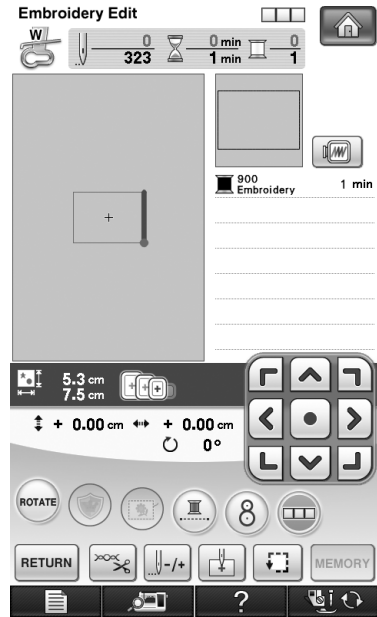

- 8 When the following message appears, press

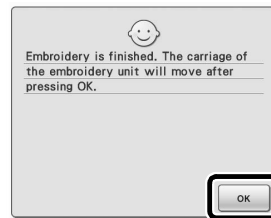

- 9 Follow the machine's on-screen instructions until the two stickers are detected. For details, refer to steps 9 through 11 in "Practice (Connecting Three Patterns)" on page 14.

- 10 After the two stickers have been detected, the following message appears. With the stickers remaining affixed, remove the frame, and then press .

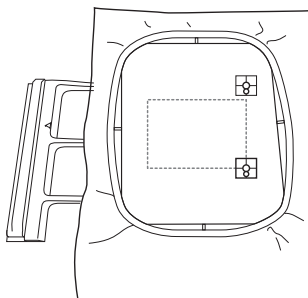
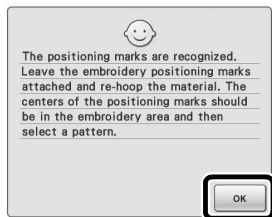

- 11 If the fabric cannot be rehooped so that the next pattern and the centers for the large circles of the two stickers are within the embroidering area, hoop the fabric with the centers for the large circles of the two stickers within the embroidering area and the next pattern as close as possible to being within the embroidering area, and then attach the frame to the machine.

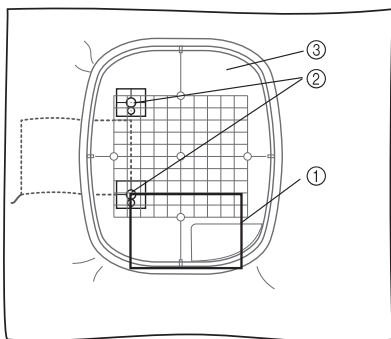

- ① Pattern to be embroidered next
- ② Centers of large circles for stickers
- ③ Embroidery sheet



Note

- When rehooping the fabric, the centers for the large circles of the two stickers should be positioned within the embroidering area. If they are not within the embroidering area, the stickers cannot be repositioned.

- 12 Select the second pattern, and then continue to the sewing screen. For this example, select the same pattern as the first one.

- 13 When the pattern connection setting screen (screen for connecting the selected pattern to the previous one) appears, press .

- To return to the embroidery edit screen, press

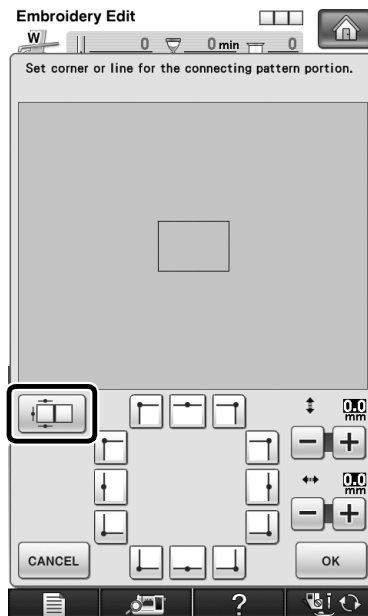

- 14 Without changing the reference edge and reference point settings, press .

- To return to the previous screen, press .

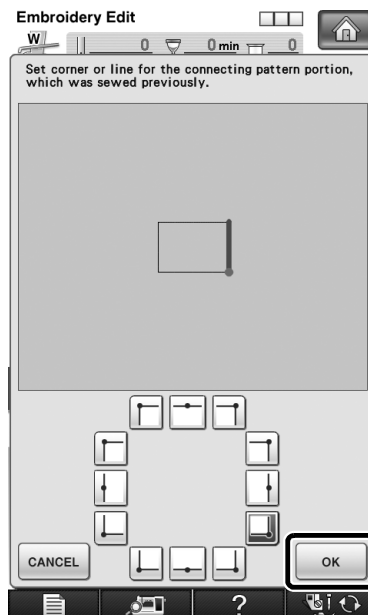

- 15 After the following message appears, select the area containing one of the two affixed stickers, and then press **SCAN**.

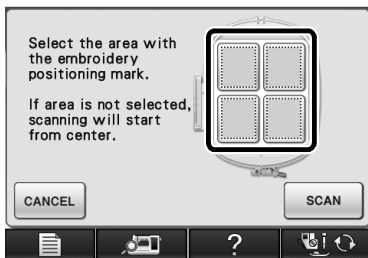

→ The camera detects the two stickers.



Note

- If an error message appears, refer to page 19 to solve the problem.

- 16 When the following message appears, remove the two stickers, and then re-affix them so that the fabric can be rehooped with the next pattern within the embroidering area. This time, keep the distance between stickers 5 cm (2 inches) or more. After the stickers have been affixed, press **SCAN**.

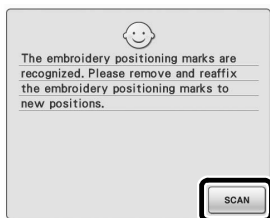
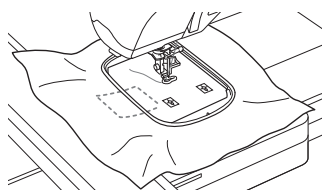
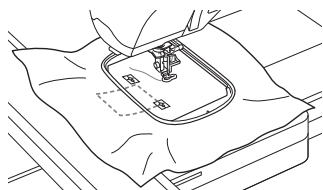

Note

- If the stickers are re-affixed within or near the area where the next pattern is to be embroidered, the stickers and the next patterns will fit within the embroidering area more easily after being rehooped.
- When the following message appears, reattach the stickers within the embroidering area.

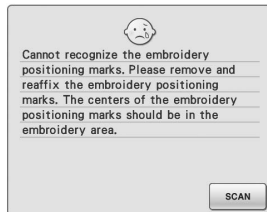

The message above may also appear when the sticker is attached slightly out of the embroidering area. In that case, reattach the stickers so that they fit more within the embroidering area.

- 17 If the stickers has been successfully detected, the following message appears. Press **CLOSE**.

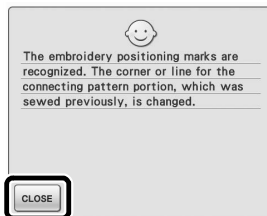

- 18 Hoop the fabric so that the next pattern and the centers for the large circles of the two marks are within the embroidering area, and then attach the embroidery frame to the machine.

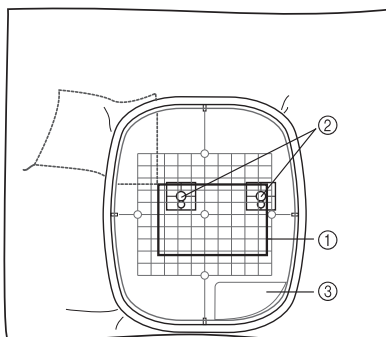

- ① Pattern to be embroidered next
- ② Centers of large circles for stickers
- ③ Embroidery sheet

- 19 When the pattern connection setting screen (screen for connecting the selected pattern to the previous one) appears, select the reference edge and reference point for connecting this pattern to the next one, and then press **OK**. For this example, select the top point of the left edge, and then press **OK**.

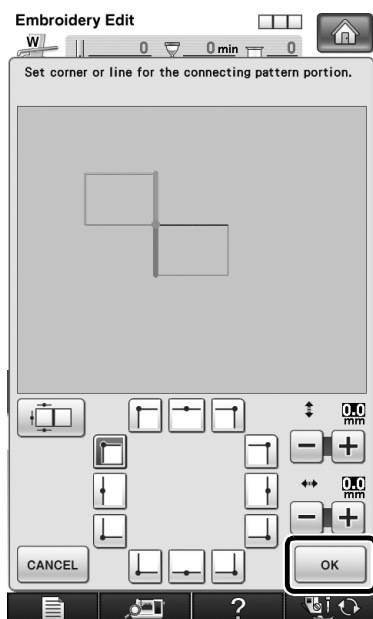
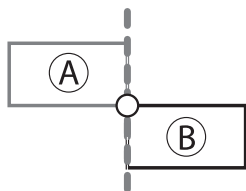

- 20 Select the area containing one of the two stickers, and then press **SCAN**.

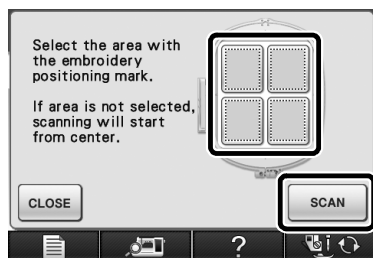

- 21 After the stickers have been detected, press **CLOSE**, and then remove the stickers.

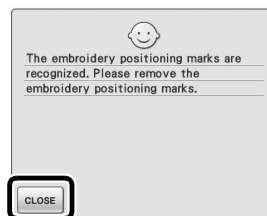

Note

- If an error message appears, refer to page 19 to solve the problem.

CONNECTING ROTATED PATTERNS

Greater design variations can be created by rotating patterns. The following procedure describes how to connect patterns that are rotated.

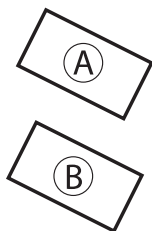

A: First pattern
B: Second pattern

- 1 Select the pattern, and then press **SET**.

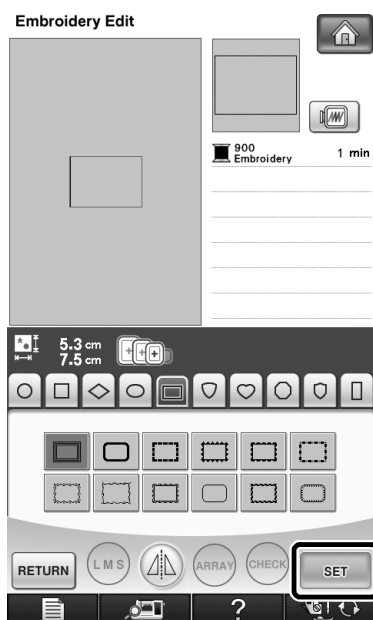

→ The pattern editing screen appears.

- 2 Press **ROTATE** in the pattern editing screen.

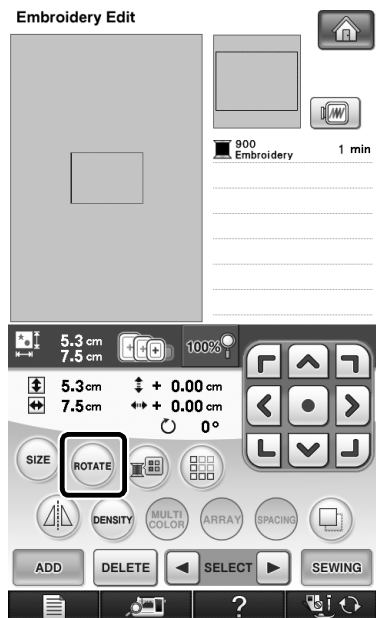

- 3 Rotate the pattern, and then press **CLOSE**.

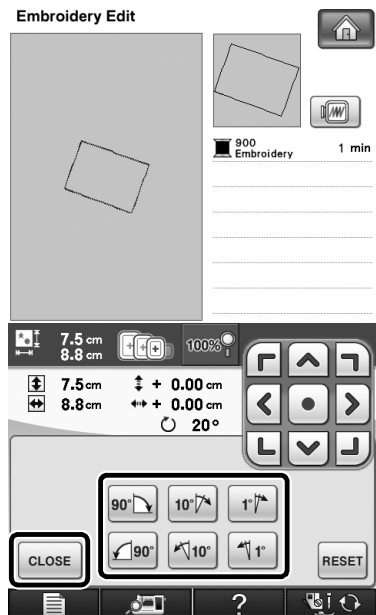

4 Press **SEWING** to display the sewing screen.

5 Press .

6 Select the reference edge and reference point for connecting this pattern to the next one.

Press **CLOSE**.

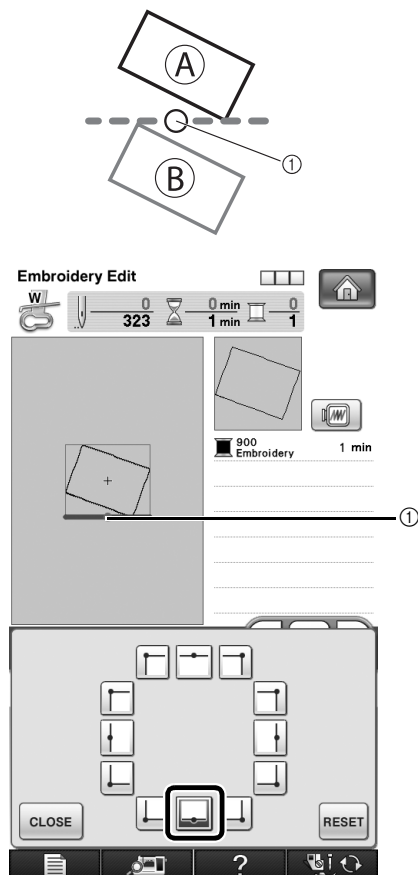

① Reference edge and reference point of first pattern

Note

- Be sure to rotate the pattern from the pattern editing screen. The reference edge and reference point are specified along the smallest rectangle (not angled) that contains all patterns selected when the sewing screen is displayed.
- Pressing **ROTATE** in the sewing screen changes the angle at which patterns are connected.

7 Refer to steps 7 through 13 of “Practice (Connecting Three Patterns)” to embroider the first pattern and rehoop the fabric.

8 Select the next pattern, and then continue to the sewing screen.

9 When the pattern connection setting screen (screen for connecting the selected pattern to the previous one) appears, select the reference edge and reference point corresponding to those for the first pattern, and then press **OK**.

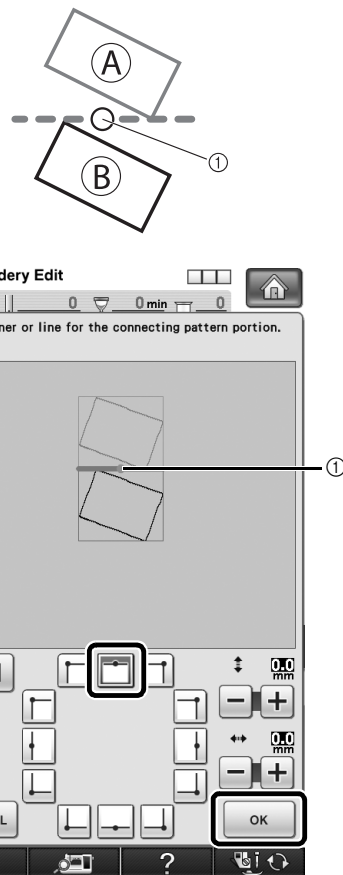

① Reference edge and reference point

10 Continue with step 16 of “Practice (Connecting Three Patterns)” to finish connecting the patterns.

CHANGING THE REFERENCE EDGE AND REFERENCE POINT FOR CONNECTING THE NEXT PATTERN AFTER A PATTERN HAS BEEN EMBROIDERED

The reference edge and reference point for connecting the next pattern can be changed after a pattern has been embroidered.

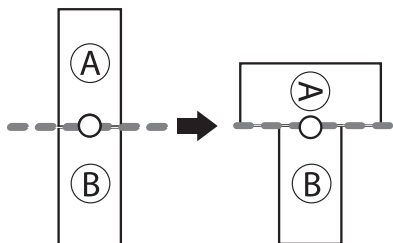

A: First pattern
B: Second pattern

- 1 Perform the procedure in “Practice (Connecting Three Patterns)” up to step 14, and then press  in the pattern connection setting screen (screen for connecting the pattern to the previous one).

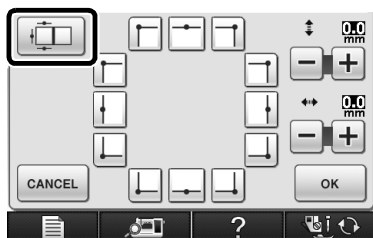

- 2 Select the new reference edge and reference point for connecting the pattern, and then press  .

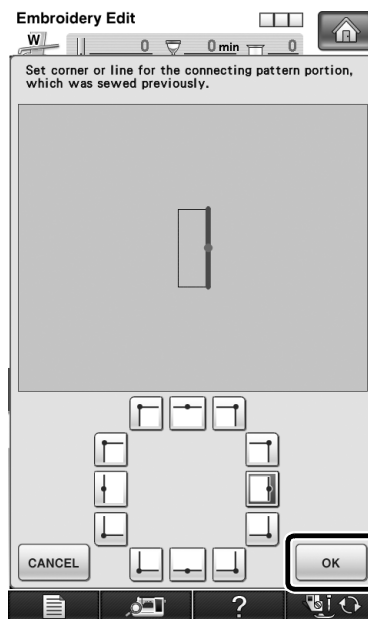
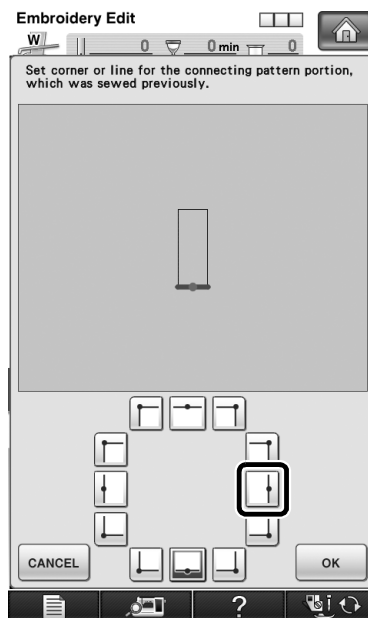

- To return to the previous screen, press  .

- 3 After the following message appears, select the area containing one of the two affixed stickers, and then press **SCAN**.

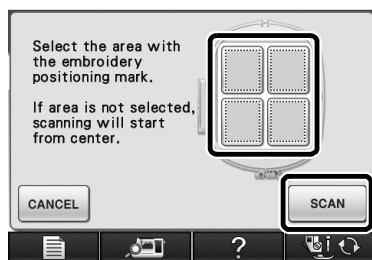

- 4 After the stickers have been successfully detected, the following message appears. Remove the two stickers, and then press **OK**.

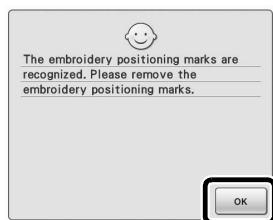

- 5 Affix the first embroidery positioning sticker onto the fabric within the red lines by using both hands to press down on each corner of the sticker, and then press **OK**. Affix the sticker with the large circle at the top as shown on the machine's screen.

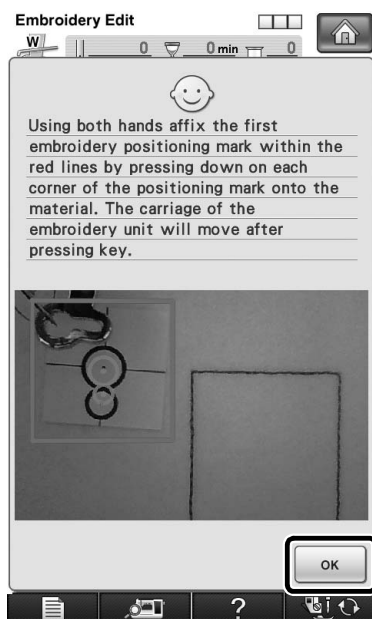

- 6 Using both hands affix the second embroidery positioning sticker within the red lines by pressing down on each corner of the positioning sticker onto the material and then touch **OK**.

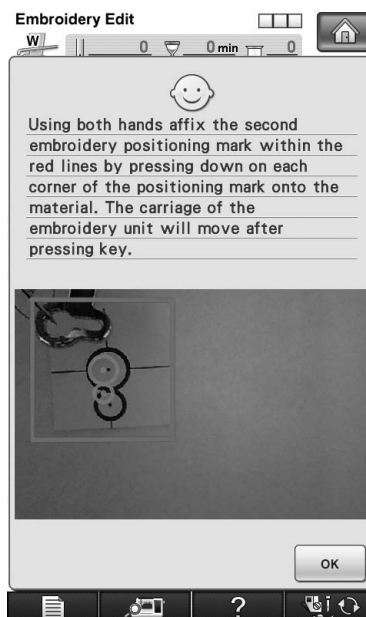

- 7 If the stickers have been successfully detected, the following message appears. Press **CLOSE**.

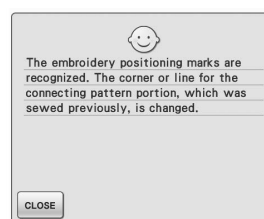

→ The reference point for connecting a pattern is changed.

- 8 When the pattern connection setting screen (screen for connecting the selected pattern to the previous one) appears, select the reference edge and reference point, and then press **OK**.

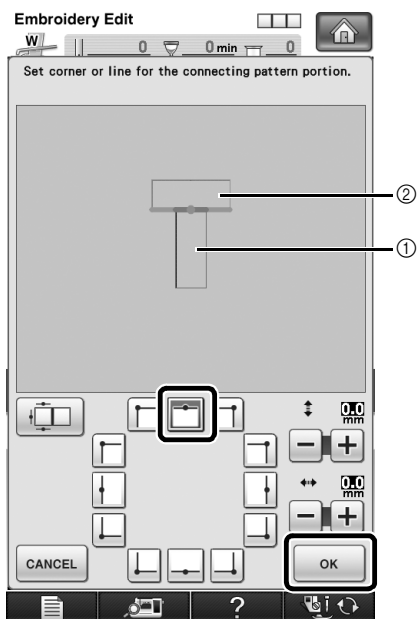

- ① Second pattern (B)
- ② First pattern (A)

- 9 Continue with step 16 of "Practice (Connecting Three Patterns)" to finish connecting patterns.

SLIDING THE POSITION OF THE PATTERN TO BE CONNECTED

When using the pattern connecting function, patterns can be connected by sliding them, instead of only aligning patterns along reference edges and reference points. This can be done when you want the pattern to be equally spaced when embroidered. The vertical and horizontal shifts can be set up to ± 99.9 mm.



Note

- The arrangement of patterns displayed in the screen may differ slightly from the actual embroidery. Use a ruler to measure the vertical and horizontal shifts before changing the settings.

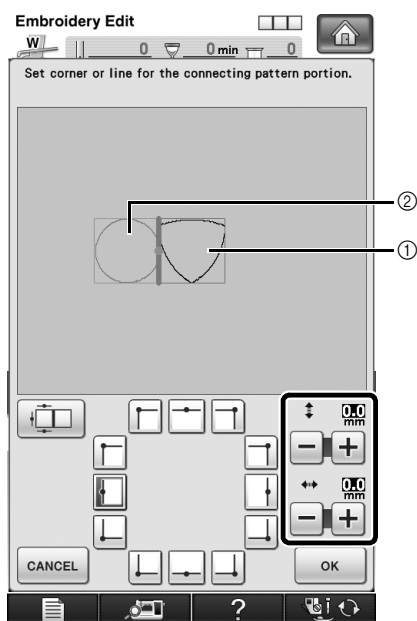

- ① Second pattern
- ② First pattern

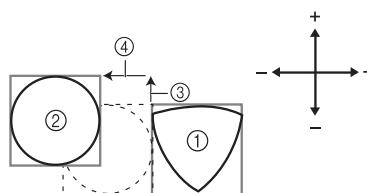
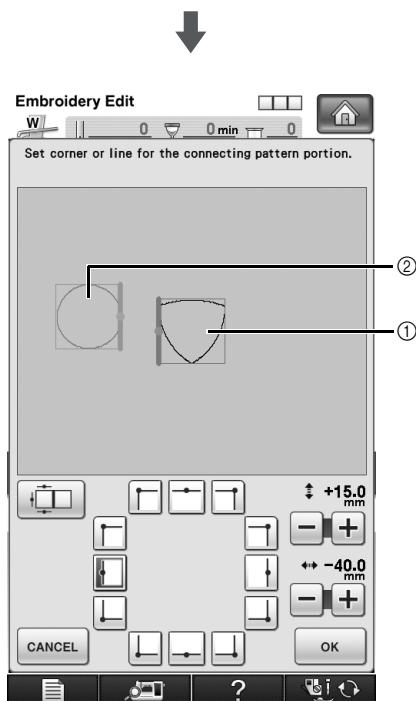

- ① Second pattern
- ② First pattern
- ③ Vertical distance : + 15.0 mm
- ④ Horizontal distance : - 40.0 mm

Connecting Patterns to be Joined Along an Edge

Greater design variations can be created by sliding the patterns being connected.

The following procedure describes how to use this function to connect patterns so they are joined along an edge. Before connecting the patterns, the basting function will be used to measure the distance that the pattern will be slid.

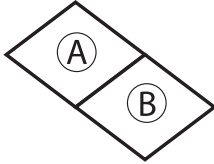

A: First pattern
B: Second pattern

■ Measuring the Distance That the Pattern Will Be Slid

- 1 Set "Embroidery Basting Distance" in the settings screen to "0.0".

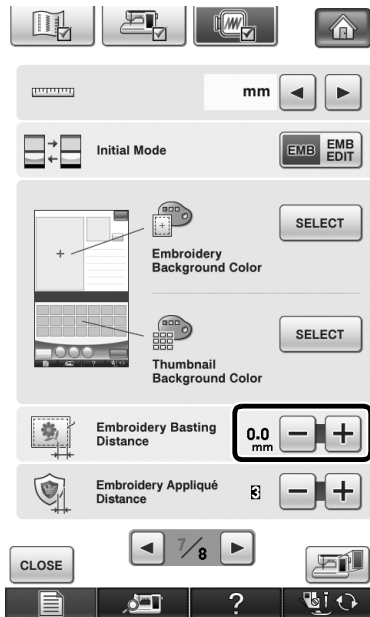

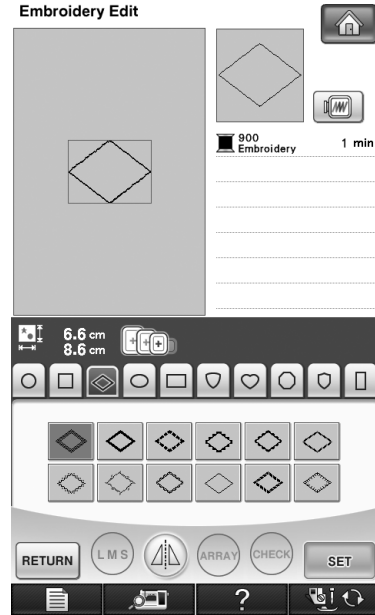

- 2 Select the pattern whose slide distance is to be measured.

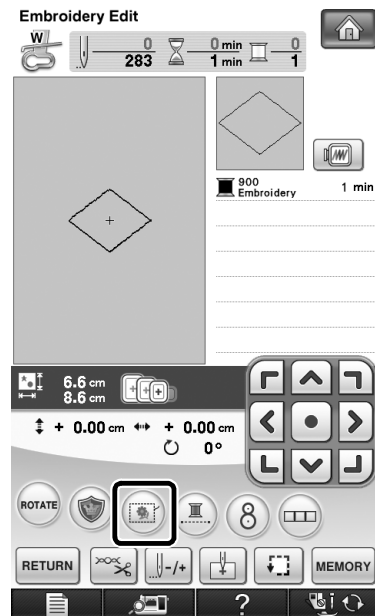

- 3 Continue to the sewing screen, and then press  to select the basting function.



→  changes to .

- 4 After the pattern is sewn, remove the fabric from the frame, and then measure the distance that the pattern is to be slid.

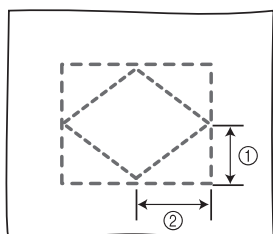

- ① Vertical: 32.8 mm
② Horizontal: 42.8 mm

■ Trial Sewing

Sew trial embroidery to check that the pattern will be slid the correct distance.

- 1 Select the pattern, and then continue to the sewing screen.
- 2 Press  in the sewing screen.
- 3 Select the reference edge and reference point for connecting this pattern to the next one.

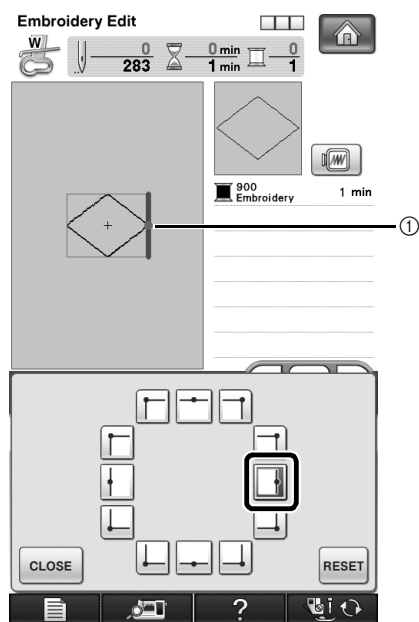
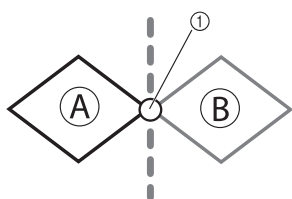

- ① Reference edge and reference point of first pattern

- 4 Refer to steps 7 through 13 of "Practice (Connecting Three Patterns)" to embroider the first pattern and rehoop the fabric.
- 5 Select the next pattern, and then continue to the sewing screen.
- 6 When the pattern connection setting screen (screen for connecting the selected pattern to the previous one) appears, select the reference edge and reference point corresponding to those for the first pattern.

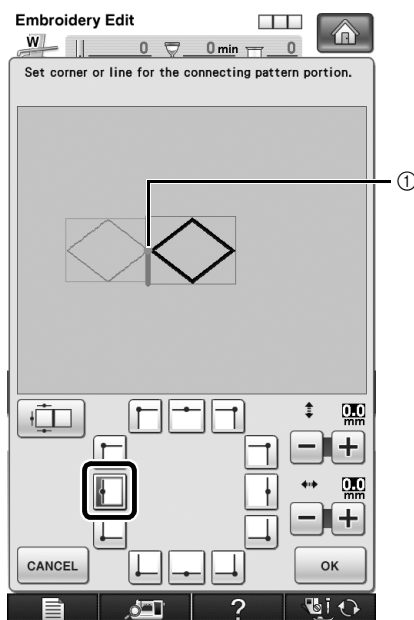
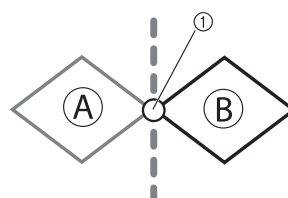

- ① Reference edge and reference point

- 7 Specify the distance that the pattern is to be slid, and then press **OK**.

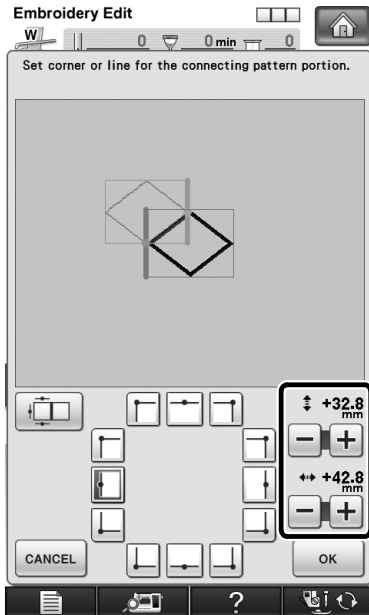
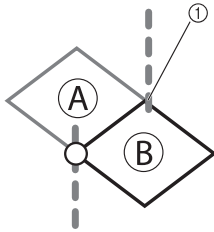

- 8 Continue with step 15 of "Practice (Connecting Three Patterns)" to finish connecting the patterns.

Note

- After checking that the trial embroidery results are satisfactory, sew the actual embroidery. If you decide to change the distance that the pattern is slid after checking the trial embroidery, change the settings selected in step 7.

TROUBLESHOOTING

If any problems occur, refer to the following to resolve them.

Operation	
1	Select the first pattern.
2	Press the pattern connection key.
3	Specify the reference point for connecting the pattern.
4	Begin embroidering the first pattern.
5	Finish embroidering the first pattern.
6	Start detecting marks (2 locations).
7	Finish detecting marks.
8	Rehoop the fabric.
9	Select the second pattern.
10	Specify the reference point for connecting the pattern.
11	Start detecting marks (2 locations).
12	Finish detecting marks.
13	Remove the two stickers.
14	Specify the reference point for connecting the pattern.
15	Begin embroidering the second pattern.
16	Finish embroidering the second pattern.
17	Start detecting marks (2 locations).
18	Finish detecting marks.
19	Rehoop the fabric.
20	Select the third pattern.
21	Specify the reference point for connecting the pattern.
22	Start detecting marks (2 locations).
23	Finish detecting marks.
24	Remove the two stickers.
25	Specify the reference point for connecting the pattern.
26	Begin embroidering the third pattern.
27	Finish embroidering the third pattern.

Operation: No. 8 & 19

Issue: When rehooping the fabric, a sticker peels off the fabric.

Solution: The patterns cannot be connected. Restart the procedure from the beginning.

Operation: No. 8, 11, 19 & 22

Issue: The next pattern to be embroidered and the centers of the large circles on the stickers do not fit within the embroidering area.

Solution1: Change the embroidery frame to a larger one.

Solution2: Reposition the stickers so that they fit within the embroidering area. With the embroidery frame remaining attached to the machine, select the next pattern, and then continue with the procedure in "CHANGING THE POSITION OF A STICKER" on page 22.



Operation: No. 10 & 21

Issue: You wish to change the selected reference point.

Solution: The selected reference point can be changed. For details, refer to "CHANGING THE REFERENCE EDGE AND REFERENCE POINT FOR CONNECTING THE NEXT PATTERN AFTER A PATTERN HAS BEEN EMBROIDERED" on page 29.

Operation: No. 16

Issue: The pattern was embroidered before the reference point for connecting the patterns was selected.

Solution: With the embroidery frame remaining attached to the machine, press , and then continue to the last stitch. Start sewing, and then immediately stop. Press , and then select the reference point. Finish embroidering.

Resume Feature

If the machine is turned off while the pattern connecting function is being used, the machine will return to the operation indicated below when it is turned on again. The machine operation will differ depending on when it is turned off.

Example: When connecting two patterns

Select the first pattern. Press the pattern connection key.
Specify the reference point for connecting the pattern.



Begin embroidering the first pattern.



Finish embroidering the first pattern. (A)

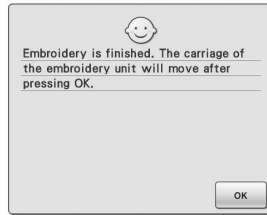

Start detecting positioning stickers (2 locations).



Finish detecting positioning stickers. (B)

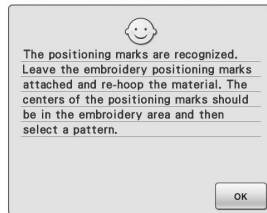

Rehoop the fabric.



Select the second pattern.



Specify the reference point for connecting the pattern.



Start detecting positioning stickers (2 locations).



Finish detecting positioning stickers.

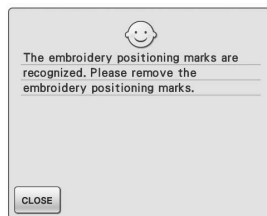

Begin embroidering the second pattern.



Finish embroidering the second pattern.

If the machine is turned off during any operation in this box, the machine will return to (A) when it is turned on again.

If the machine is turned off during any operation in this box, the machine will return to (B) when it is turned on again.

NEW FEATURES OF VERSION 2 (For NV1/NV6000D customer only)

If your machine is installed with software version 2, the following features are added after the software is upgraded.

- Previews of embroidery patterns can be magnified by 200%.
- Thumbnails of embroidery patterns can be displayed at a larger size.
- An image of the needle position being displayed by the built-in camera or an image of the Settings screen can be saved in the BMP format on USB media.
- A grid can be displayed to check the needle position in the LCD. This enables easy alignment of the needle position.
- Various improvements in operation and screen displays have been incorporated, making the machine easier to use.

For details, refer to the following descriptions.

Displaying Patterns in The Embroidery Edit Screen Magnified By 200%

In the Embroidery Edit screen, the pattern can be magnified by 200% within the embroidery display area.

- 1 Press .



→  changes to , and the pattern is magnified by 200%.

- 2 Check the displayed pattern.

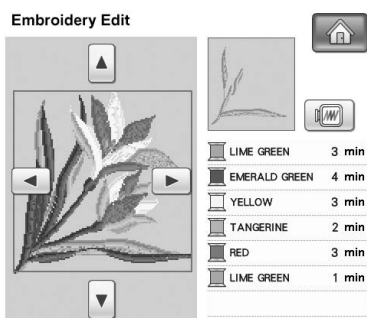

Use     to scroll through the display in any direction.

- 3 To display the pattern back to the normal size (100%), press .

Specifying The Size of Pattern Thumbnails

The thumbnails for selecting an embroidery pattern can be set to be displayed at the normal size or a larger size. The larger size is 1.5 times the normal size. The thumbnail size setting can be selected from page 8/8 of the Settings screen.

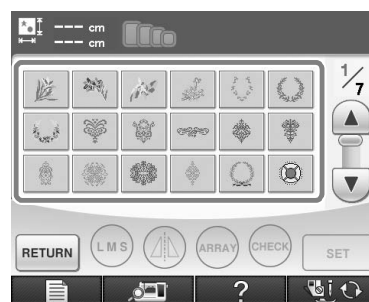

- 1 Press **-** or **+** to select the desired thumbnail size.

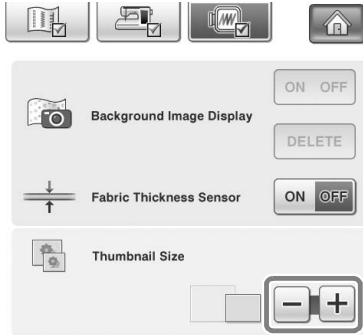

Note

- When thumbnail size setting has been changed the pattern selection screen will not immediately reflect the chosen size. To view the patterns with the new thumbnail size, return to the category selection screen, and then select the pattern category again.

Saving a Camera Image or Settings Screen Image to USB Media

An image of the needle position being displayed by the built-in camera or an image of the Settings screen can be saved as a BMP file.

A maximum of 100 images can be saved on a single USB media at one time.

- 1 Insert the USB media into the primary (top) USB port on the right side of the machine.

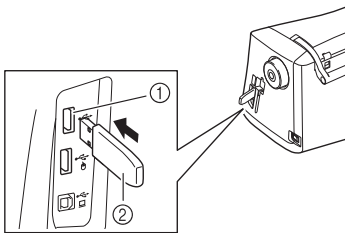

- ① Primary (top) USB port
- ② USB media

Note

- If two USB medias are inserted simultaneously, the files will be saved only on the USB media inserted first.

- 2 Display the screen to be saved, and then save the displayed image.

Note

- An image can be captured only of screens containing the indicated key .

■ To save an image of the needle position displayed by the built-in camera

Memo

- For details about using the built-in camera to display the needle position, refer to “Checking the Needle Location in the Screen” in the machine’s Operation Manual.

Press .

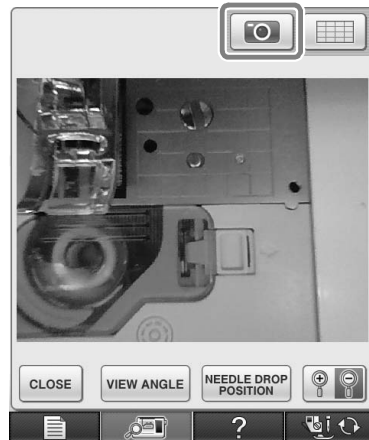

→ The image file will be saved to the USB media.

■ To save an image of the Settings screen



Memo

- For details about displaying the Settings screen, refer to "Using the Machine Setting Mode Key" in the machine's Operation Manual.

Press .

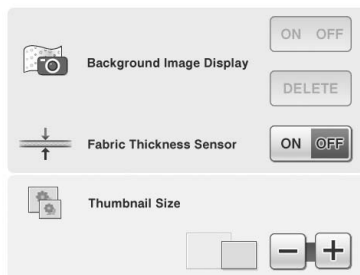

→ The image file will be saved to the USB media.

3 Remove the USB media, and then check the saved image(s) using a computer.

The files for camera images are saved with the name "C*.BMP", and the files for Settings screen images are saved with the name "S*.BMP".

- "*" in the names "C*.BMP" and "S*.BMP" will automatically be replaced with a number between 00 and 99.



Note

- If 100 image files have already been saved on the USB media, the following message appears. In this case, delete a file from the USB media or use different USB media.



Displaying The Grid

A grid can be displayed when the built-in camera is used to display the needle position in the LCD.



Memo

- For details on using the built-in camera to display the needle position, refer to "Checking the Needle Location in the Screen" in the machine's Operation Manual.

1 Press .



→ The grid appears.



- To turn the grid off, press .

Other New Features

- If an area is not selected while using the built-in camera to align the embroidering position, scanning will start from the center.

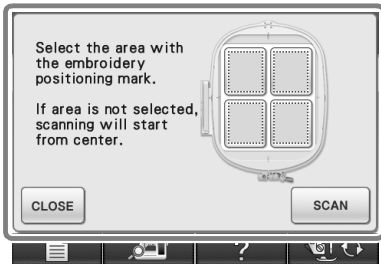

Note

- Scanning cannot start from the center after an area has been selected. To scan from the center, press **CLOSE** to close the window, then display the window again but do not select an area to scan, then press **SCAN**.

- The image of the needle position displayed by the built-in camera can be magnified by 200%.

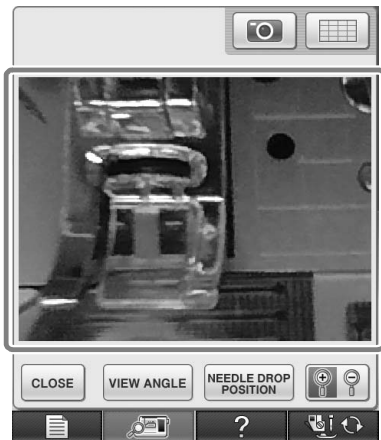

- The parameters in the Settings screens can also be displayed in a language other than English.

Example: Deutsch (German) screen



- When combining character patterns, the stitching connecting patterns (jump stitches) are no longer displayed in the preview so that the patterns can be viewed more clearly.

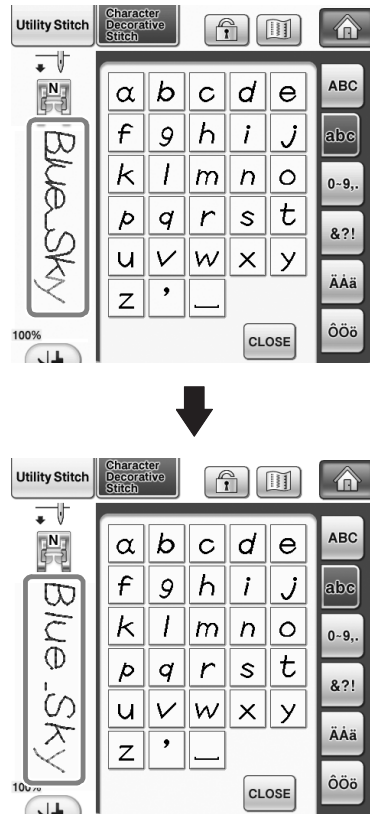

Note

- Jump stitches may be displayed on the character.

- If twin needle sewing has been selected, the stitching is displayed in the preview as two rows of stitching.

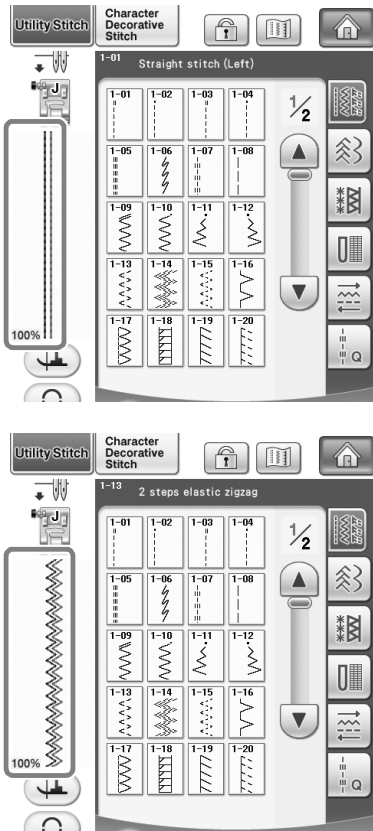

Memo

- Two rows of stitching are displayed even if [] was pressed.

- When pressing the keys for advancing/returning to a page, for example, in the pattern selection screen, the pages are scrolled through continuously (from the last page directly to the first page or from the first page directly to the last page).

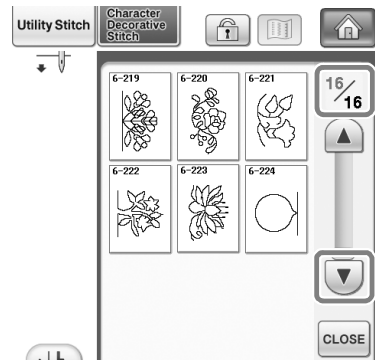
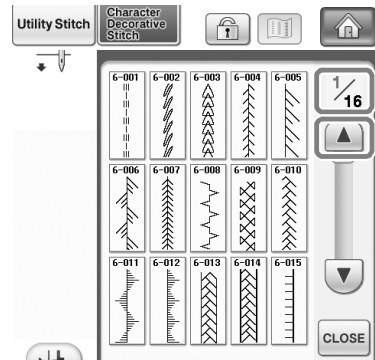

Note

- The pages displayed after [] is pressed cannot be scrolled through continuously.

Settings screen

- Since functions have been added, a page has been added to the Settings screen. New settings available with Upgrade Kit (sold separately) are added.



Note

- For details on Upgrade Kits, visit our website "www.brother.com" or contact your authorized Brother dealer.

- The keys for these new functions are activated when the Upgrade Kit I is purchased and Certification has been completed on machine.

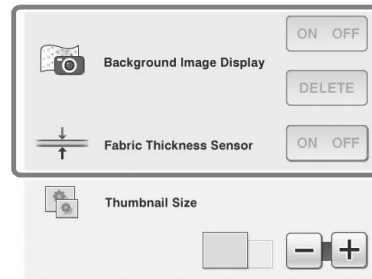

- Background Image Display and Fabric Thickness Sensor are activated after Upgrade Kit I is installed and certified.

New Patterns for Version 2

■ Character Decorative Stitch

Utility Stitch | Character Decorative Stitch

AB

AB

AB

■ Embroidery/Embroidery Edit

Embroidery

CLOSE

Always press when removing Embroidery unit.

ABC

ABC

44

COLOR CHANGE TABLE FOR THE EMBROIDERY PATTERNS ON THE CD-ROM



Memo

- These files can be opened with PE-DESIGN Ver.8 or higher version on your computer.
- Patterns marked with ● have been rotated. Check your design placement prior to embroidering.
- In this section, the sizes of embroidery patterns describe the sizes when you recall the pattern to your sewing machine.

No. 01 : XKIT3B01.pes

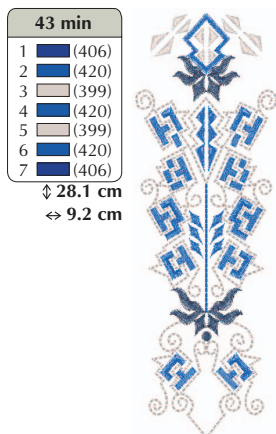

● No. 04 : XKIT3B04.pes

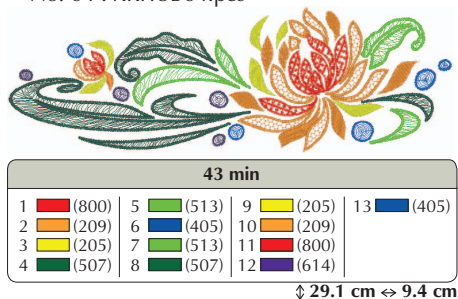

● No. 02 : XKIT3B02.pes

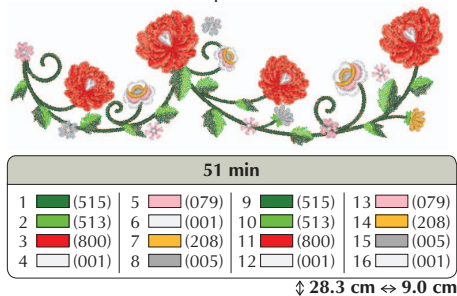

● No. 05 : XKIT3B05.pes

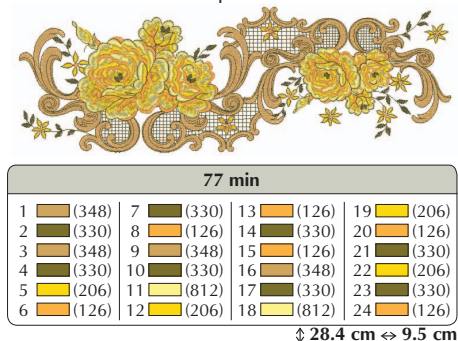

● No. 03 : XKIT3B03.pes

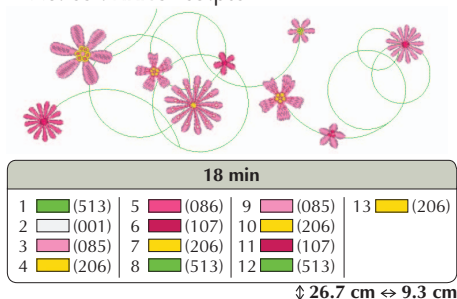

● No. 06 : XKIT3B06.pes

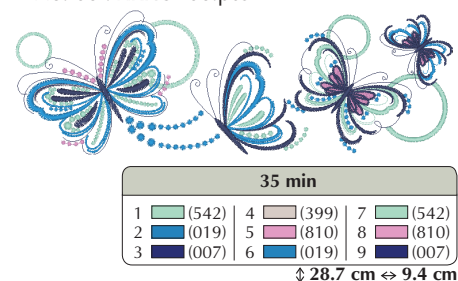

No. 07 : XKIT3B07.pes

17 min	
1	(406)
2	(509)
3	(206)
4	(337)
5	(406)
6	(509)
7	(206)
8	(337)
9	(406)
10	(509)
11	(206)
12	(337)
13	(406)

↓ 28.4 cm
↔ 9.4 cm



● No. 09 : XKIT3B09.pes



27 min			
1	(420)	6	(420)
2	(079)	7	(079)
3	(017)	8	(420)
4	(027)	9	(027)
5	(399)	10	(017)
11	(399)	12	(420)
13	(079)	14	(027)
15	(017)	16	(399)
17	(420)	18	(001)
19	(027)	20	(420)

↓ 26.7 cm ↔ 6.0 cm

● No. 08 : XKIT3B08.pes



18 min			
1	(348)	5	(209)
2	(209)	6	(348)
3	(323)	7	(209)
4	(206)	8	(323)
9	(206)	10	(209)
11	(348)	12	(323)
13	(209)		

↓ 21.6 cm ↔ 6.9 cm

● No. 10 : XKIT3B10.pes



55 min			
1	(509)	9	(614)
2	(810)	10	(612)
3	(515)	11	(202)
4	(534)	12	(085)
5	(086)	13	(807)
6	(085)	14	(612)
7	(534)	15	(085)
8	(509)	16	(086)
17	(807)	18	(534)
19	(509)	20	(515)
21	(534)	22	(202)
23	(807)	24	(614)
25	(807)	26	(085)
27	(612)	28	(614)
29	(202)	30	(807)

↓ 29.2 cm ↔ 8.9 cm

