

brother®

**Q**uick Reference Guide

**S**tichwortregister

**G**uide de référence rapide

**B**eknopte bedieningsgids

**G**uida di riferimento rapido

**G**uía de referencia rápida

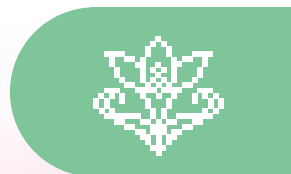
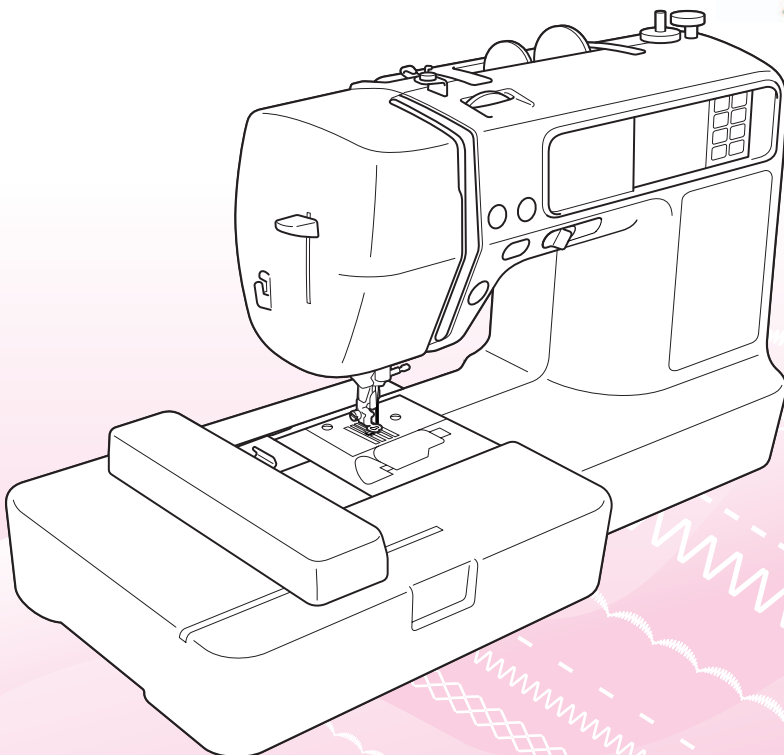
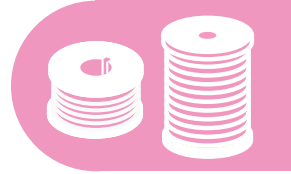

**Refer to the operation manual for detailed instruction.**

Also, there are differences in the keys and screens depending on the display language. In this guide, English screens are used for basic explanations.

**Einzelheiten entnehmen Sie bitte der Bedienungsanleitung.**

Je nachdem, welche Sprache für die Bildschirmanzeigen gewählt wurde, ergeben sich im Hinblick auf Tasten und Displaybildern eventuell Unterschiede.

Die grundlegende Bedienung der Maschine ist in dieser Anleitung am Beispiel von Displayabbildungen mit englischem Text erklärt.

**Pour les instructions détaillées, voir le mode d'emploi.**

Par ailleurs, il y a des différences dans les touches et les écrans en fonction de la langue d'affichage. Dans ce guide, les explications de base utilisent les écrans anglais.

**Zie de gebruiksaanwijzing voor gedetailleerde instructies.**

Er zijn verschillen in de toetsen en schermen afhankelijk van de ingestelde taal.

In de beschrijvingen in deze beknopte handleiding worden de Engelse schermen gebruikt.

**Fare riferimento al manuale di impiego per istruzioni dettagliate.**

Inoltre, ci sono differenze nei tasti e nelle schermate a seconda della lingua visualizzata.









In questa guida, le schermate in inglese sono usate per le spiegazioni basilari.

**Consulte el manual de instrucciones para ver más detalles.**

Además, dependiendo del idioma visualizado algunos botones y pantallas podrán ser diferentes.

En esta guía, para las explicaciones básicas se emplean pantallas en inglés.

Contents	Inhalt	Table des matières	Inhoudsopgave	Indice	Contenido
----------	--------	--------------------	---------------	--------	-----------

	<b>Machine Features</b> Caractéristiques de l'appareil Caratteristiche della macchina		<b>Eigenschaften der Maschine</b> Kenmerken van de machine Características de la máquina		<b>2</b>
	<b>Bobbin Winding and Setting</b> Bobinage et réglage de la canette Avvolgimento spolina e caricamento		<b>Aufspulen des Unterfadens und Einstellung</b> Opwinden en instellen van de spoel Bobinado y ajuste		<b>4</b>
	<b>Upper Threading</b> Enfilage supérieur Infilatura superiore	<b>Einfädeln des Oberfadens</b> Inrijgen van de bovendraad Hilo superior			<b>6</b>
	<b>Selecting Stitch Patterns</b> Sélection des configurations de point Selezione degli schemi punto		<b>Wahl des Nähmusters</b> Kiezen van de steekpatronen Selección de tipos de puntada		<b>8</b>
	<b>Summary of Stitch Patterns</b> Sommaires des motifs de point Sommario degli schemi punto		<b>Nähmuster-Übersicht</b> Overzicht van de steekpatronen Resumen de tipos de puntada		<b>10</b>
	<b>Preparing to Embroider</b> Préparation de la broderie Preparativi per il ricamo		<b>Vorbereitung zum Sticken</b> Vorbereidingen voor borduren Preparativos para bordar		<b>13</b>
	<b>Selecting Embroidery Patterns</b> Sélection des motifs de broderie Selezione degli schemi di ricamo		<b>Wählen von Stickmustern</b> Kiezen van borduurpatronen Selección de diseños de bordados		<b>15</b>
	<b>Alphanumeric Character Patterns</b> Motifs de caractères alphanumériques Schemi dei caratteri alfanumerici		<b>Alphanumerische Buchstabenmuster</b> Patronen met alfanumerieke karakters Patrón de caracteres alfanumérico		<b>21</b>
	<b>Frame Patterns</b> Motifs cadres Motivi a cornicetta	<b>Rahmenmuster</b> Kaderpatronen Costuras de encuadre			<b>23</b>
	<b>Embroidery Pattern Color Change Table</b> Tableau de changement de couleur des motifs de broderie Tabella di cambiamento colori degli schemi di ricamo		<b>Stickmuster-Farbtabelle</b> Kleurwijzigingstabel voor de borduurpatronen Tabla de cambio de color para patrones de bordado		<b>24</b>
	<b>Color Thread Conversion Chart</b> Tableau de conversion des fils de couleur Tabella di conversione dei fili colorati		<b>Stickgarn-Farbtabelle</b> Omzettingstabel voor kleurgaren Tabla de conversión de hilos de color		<b>28</b>



## Machine Features Caractéristiques de l'appareil Caratteristiche della macchina

## Eigenschaften der Maschine Kenmerken van de machine Características de la máquina

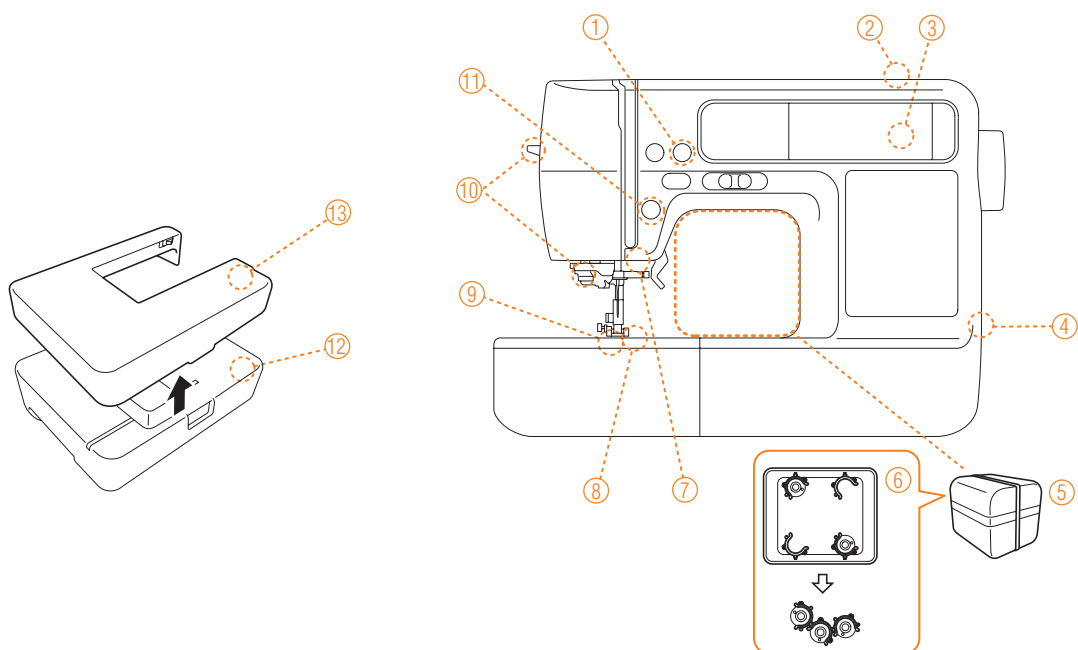

- ① **Automatic thread cutting:** The thread can be cut automatically after sewing.
- ② **Fast bobbin winding system:** With the fast and simple bobbin winder, you can wind bobbins with one press of a button.
- ③ **Built-in stitches:** You can select from the built-in stitches available, including utility stitches and decorative stitches.
- ④ **USB port:** Embroidery patterns saved in a USB flash drive (USB flash memory) can be imported to the machine by plugging the USB flash drive directly into the USB port.
- ⑤ **Accessory case:** You can store the accessory case inside the arm of the machine as shown in the figure. Presser foot, bobbins, a seam ripper, etc. can be stored in this case.
- ⑥ **Bobbin clip:** You can use the bobbin clip to prevent the end of the thread wound onto the bobbin from loosening. Bobbin clips can be stored inside of the accessory case cover.
- ⑦ **Bright light:** The convenient LED lamp makes it easy to work on dark fabrics.
- ⑧ **Seven-point feed dogs:** Ensure smooth, even feeding of multiple fabric layers and a variety of fabric weights.
- ⑨ **Quick-set bobbin:** You can start sewing without pulling up the bobbin thread.
- ⑩ **Easy-to-use needle threader:** You can thread the needle easily by one press of a lever.
- ⑪ **Lighting Start/Stop button:** When the green light is on, the machine is ready to sew. A red or orange light indicates an error or that the machine is warming up.
- ⑫ **Embroidery:** You can embroider built-in embroidery patterns, alphanumeric characters, framed decorations, and designs from optional embroidery cards.
- ⑬ **Extension table (Cover of the embroidery unit):** You can use the cover of the embroidery unit as the extension table when you sew a large material.

- ① **Automatischer Fadenabschneider:** Nach dem Nähen kann der Faden automatisch abgeschnitten werden.
- ② **Schnell-Aufspulsystem:** Mit der schnellen und einfachen Aufspulvorrichtung können Sie Spulen per Knopfdruck aufspulen.
- ③ **Einprogrammierte Stiche:** Sie können aus den vorhandenen einprogrammierten Stichen wählen, einschließlich Nutstiche und Dekorstiche.
- ④ **USB-Anschluss:** Stickmuster, die in einem USB-Flashlaufwerk (USB-Flashspeicher) gespeichert wurden, können ins Gerät importiert werden, durch direkten Anschluss des USB-Flashlaufwerks an den USB-Anschluss.
- ⑤ **Zubehörtaische:** Sie können die Zubehörbox, wie in der Abbildung angegeben, im Arm der Maschine aufbewahren. Der Nähfußhebel, Garnrollen, ein Pfeiltrenner usw. können in dieser Box aufbewahrt werden.
- ⑥ **Spulenclip:** Sie können den Spulenclip verwenden, um zu verhindern, dass sich das auf die Spule gewickelte Fadenende abrollt. Spulenclips können in der Zubehörbox aufbewahrt werden.
- ⑦ **Helle Leuchte:** Die praktische LED-Leuchte erleichtert die Arbeit mit dunklen Stoffen.
- ⑧ **Sieben-Punkt-Transporteur:** Dieser sorgt für eine optimale, gleichmäßige Führung mehrerer Stoffschichten und zahlreicher Stoffarten.
- ⑨ **Unterfaden-Schnellautomatik:** Sie können mit dem Nähen beginnen, ohne den Unterfaden von Hand aufnehmen zu müssen.
- ⑩ **Praktischer Nadeleinfädler:** Sie können den Faden durch Betätigung eines Hebels einfädeln.
- ⑪ **Beleuchtete Start/Stopp-Taste:** Wenn die grüne Lampe brennt, ist die Maschine für den Nähvorgang bereit. Eine orangefarbene Leuchte zeigt einen Fehler an oder, dass die Maschine noch aufwärmt.
- ⑫ **Sticken:** Sie können gespeicherte Stickmuster, Buchstabenmuster, Randdekorationen und Motive von optionalen Stickmusterkarten sticken.
- ⑬ **Auflageerweiterung (Abdeckung der Stickeinheit):** Sie können die Abdeckung der Stickeinheit als Auflageerweiterung verwenden, wenn Sie große Materialien vernähen.

- ① **Découpe automatique du fil** : le fil peut être coupé automatiquement une fois la couture terminée.
- ② **Système d'enroulement rapide des bobines** : vous pouvez bobiner les canettes d'un simple clic sur un bouton grâce au bobineur de canette simple et rapide.
- ③ **Points de couture intégrés** : vous pouvez choisir des points de couture intégrés dans la liste disponible, notamment des points de couture utilitaires et décoratifs.
- ④ **Port USB** : des motifs de broderie enregistrés sur un lecteur flash USB (mémoire flash USB) peuvent être importés sur la machine en branchant directement le lecteur flash USB au port USB.
- ⑤ **Boîtier pour accessoires** : vous pouvez stocker le boîtier pour accessoires dans le bras de la machine, comme il est illustré dans le schéma. Vous pouvez stocker le pied-de-biche, les bobines, un découd-vite dans ce boîtier.
- ⑥ **Pince de bobines** : vous pouvez utiliser la pince de bobines pour empêcher l'extrémité du fil caneté sur la bobine de se relâcher. Vous pouvez stocker les pinces de bobines dans le couvercle du boîtier pour accessoires.
- ⑦ **Fortes lumière** : la lampe à DEL est pratique et facilite votre travail sur des tissus sombres.
- ⑧ **Griffes d'entraînement à sept points** : garantie d'une alimentation lisse et régulière de plusieurs couches de tissu et d'une variété de poids du tricot.
- ⑨ **Bobine à prise rapide** : vous pouvez commencer à coudre sans cabrer le fil de la bobine.
- ⑩ **Enfileur d'aiguille facile à utiliser** : vous pouvez enfiler facilement l'aiguille d'un simple clic sur un levier.
- ⑪ **Bouton Marche/Arrêt de l'éclairage** : lorsque la lumière verte est allumée, la machine est prête. Une lumière rouge ou orange indique une erreur ou signale le réchauffement de la machine.
- ⑫ **Broderie** : vous pouvez brocher des motifs de broderie, des caractères alphanumériques, des décorations encadrées et des dessins sur la base de patrons de broderie intégrés à la machine ou disponibles sur cartes livrées en option.
- ⑬ **Table à allonges (couverture d'une broderie)** : vous pouvez utiliser la couverture d'une broderie comme une table à allonges lors de la couture d'un grand tissu.

- ① **Automatisch draad afknippen**: de draad kan na het naaien automatisch worden afgeknipt.
- ② **Snel spoelopwindsysteem**: met de snelle en eenvoudig te bedienen spoelopwinder windt u spoelen op met één druk op de knop.
- ③ **Voorgeprogrammeerde steken**: u kunt kiezen uit diverse functionele en decoratieve steken die in de machine zijn voorgeprogrammeerd.
- ④ **USB-poort**: Als u borduurpatronen opgeslagen op een USB-flasstation (USB-flasheugen) naar de machine wilt importeren, plaatst u het USB-flasstation direct in de USB-poort.
- ⑤ **Accessoiredoos**: u kunt de accessoiredoos opbergen in de arm van de machine zoals aangegeven op de afbeelding. De doos biedt ruimte voor persvoeten, spoelen, tormmesjes etc.
- ⑥ **Spoelclip**: met de spoelclip voorkomt u dat het einde van de draad die op de spoel is gewonden, loskomt. U kunt uw spoelclips bewaren in de accessoiredoos.
- ⑦ **Heldere verlichting**: de heldere LED-lamp vergemakkelijkt het werken met donkere stoffen.
- ⑧ **Zevenpunts-transporteurs**: de transporteurs garanderen een soepele, gelijkmatige toevoer, ook bij meerdere stoflagen en bij diverse materiaalgewichten.
- ⑨ **Snel instelbare spoel**: u kunt beginnen met naaien zonder eerst de spoeldraad omhoog te hoeven trekken.
- ⑩ **Gebruiksvriendelijke draaddoorhaler**: door de hendel één keer in te drukken haalt u de draad door de naald.
- ⑪ **Start/stop-knop met lampjes**: wanneer het groene lampje brandt, is de machine klaar voor gebruik. Een rood of oranje lampje geeft aan dat er een fout is opgetreden of dat de machine aan het opwarmen is.
- ⑫ **Borduren**: u kunt werken met in de machine voorgeprogrammeerde borduurpatronen, karakters en decoraties, maar ook met ontwerpen op optionele borduurkaarten.
- ⑬ **Uitbreidingstafel (deksel van de borduureenheid)**: bij het naaien van een groot werkstuk kunt u het deksel van de borduureenheid gebruiken als uitbreidingstafel.

- ① **Taglio automatico del filo**: è possibile tagliare automaticamente il filo dopo la cucitura.
- ② **Sistema rapido di avvolgimento della spolina**: grazie all'avvolgitore spolina semplice e veloce, è possibile avvolgere le spoline prendendo semplicemente un pulsante.
- ③ **Punti integrati**: è possibile scegliere fra i punti integrati disponibili, inclusi punti utili e punti decorativi.
- ④ **Porta USB**: Schemi di ricamo salvati in un'unità flash USB (memoria flash USB) possono essere importati nella macchina collegando l'unità flash USB direttamente alla porta USB.
- ⑤ **Borsa accessori**: la borsa degli accessori può essere sistemata all'interno del braccio della macchina, come illustrato in figura. Il piedino premistoffa, la spolina e il rifilatore possono essere conservati nella borsa accessori.
- ⑥ **Ferma spolina**: si può utilizzare la ferma spolina per evitare che la fine del filo avvolto attorno alla spolina si allenti. I ferma spolina possono essere conservati nel coperchio della borsa accessori.
- ⑦ **Illuminazione intensa**: la lampada LED consente di lavorare con facilità su stoffe scure.
- ⑧ **Alimentazione stoffa a sette punti**: assicura uno scorrimento uniforme di strati di stoffa multipli e di consistenze diverse.
- ⑨ **Sistemazione rapida della spolina**: è possibile iniziare a cucire senza fermare il filo della spolina.
- ⑩ **Infila ago facile da usare**: è possibile inserire il filo nell'ago prendendo semplicemente una leva.
- ⑪ **Pulsanti di avvio/arresto luminosi**: quando la luce verde è accesa, la macchina è pronta per la cucitura. La luce rossa o arancione indica che si è verificato un errore o che la macchina è in fase di riscaldamento.
- ⑫ **Ricamo**: per il ricamo è possibile utilizzare i disegni per ricamo integrati, i personaggi, le decorazioni incorniciate e i disegni dalle schede di ricamo opzionali.
- ⑬ **Tavolo di estensione (coperchio dell'unità di ricamo)**: è possibile utilizzare il coperchio dell'unità di ricamo come tavolo di estensione quando si cuciono tessuti di grandi dimensioni.

- ① **Corte automático del hilo**: El hilo se puede cortar automáticamente tras finalizar la costura.
- ② **Sistema de devanado rápido de la bobina**: Con la rápida y simple devanadora, puede devanar bobinas con tan solo pulsar un botón.
- ③ **Puntadas de costura incorporadas**: puede seleccionar entre las puntadas incorporadas disponibles, incluidas las puntadas funcionales y decorativas.
- ④ **Puerto USB**: Los diseños de los bordados guardados en una unidad Flash USB (memoria Flash USB) pueden ser importados a la máquina mediante la conexión directa de la unidad Flash USB al puerto USB.
- ⑤ **Caja para accesorios**: la caja para accesorios se puede guardar dentro del brazo de la máquina, como se muestra en la ilustración. En esta caja también se pueden guardar pies prensatelas, bobinas, abreoales, etc.
- ⑥ **Presilla de bobina**: se utiliza para evitar que el extremo del hilo devanado en la bobina se suelte. Las presillas de bobina se pueden guardar en la tapa de la caja para accesorios.
- ⑦ **Illuminación brillante**: La lámpara LED facilita el trabajo con telas oscuras.
- ⑧ **Dientes de arrastre de siete puntos**: Aseguran una alimentación suave y uniforme de varias capas de tela y de gran variedad de telas de peso variado.
- ⑨ **Bobina de colocación rápida**: Puede empezar a coser sin tener que tirar del hilo de la bobina.
- ⑩ **Enhebrador de aguja de uso fácil**: Puede enhebrar la aguja fácilmente con tan sólo presionar una palanca.
- ⑪ **Illuminación del botón iniciar/parar**: Cuando la luz verde está encendida, la máquina está lista para comenzar a coser. Una luz roja o anaranjada indica que hay un error o que la máquina está en proceso de calentamiento.
- ⑫ **Bordado**: Puede bordar patrons incorporados, caracteres, motivos decorativos encuadrados y patronos incluidos en tarjetas de memoria de bordado opcionales.
- ⑬ **Mesa extensible (cubierta de la unidad de bordado)**: al coser telas grandes, se puede utilizar la cubierta de la unidad de bordado como mesa extensible.

# Bobbin Winding and Setting

## Aufspulen des Unterfadens und Einstellung

### Bobinage et réglage de la canette

#### Opwinden en instellen van de spoel

#### Avvolgimento spolina e caricamento

#### Bobinado y ajuste



Follow the numbered steps below in order. Refer to the operation manual for detailed instruction.  
 Führen Sie die folgenden Schritte in der angegebenen Reihenfolge aus. Ausführliche Hinweise finden Sie in der Bedienungsanleitung.  
 Suivez, dans l'ordre, les étapes numérotées ci-dessous. Consultez le manuel d'instructions pour des procédures détaillées.  
 Voer de genummerde stappen uit in de juiste volgorde. Uitvoerige aanwijzingen vindt u in de bedieningshandleiding.  
 Seguire i passaggi numerati nell'ordine riportato di seguito. Fare riferimento al manuale d'istruzioni per le istruzioni dettagliate.  
 Realice los siguientes pasos numerados en el orden indicado. Para obtener instrucciones detalladas, consulte el manual de instrucciones.

Use only the enclosed bobbin or bobbins of the same type.  
 Verwenden Sie nur die im Lieferumfang enthaltene Spule oder Spulen vom selben Typ.  
 N'utilisez que la canette fournie ou des canettes du même type.  
 Gebruik alleen de bijgeleverde spoel of spoelen van hetzelfde type.  
 Utilizzare solo la spolina inclusa o spoline dello stesso tipo.  
 Utilice sólo la bobina incluida o bobinas del mismo tipo.

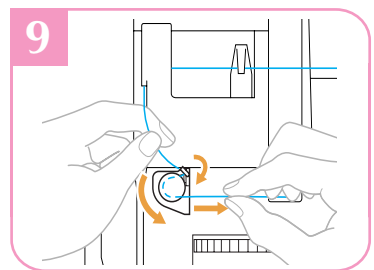
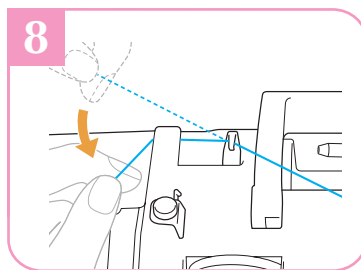
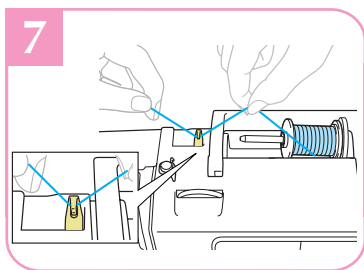
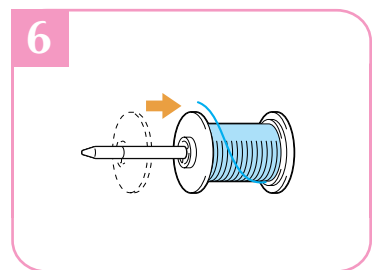
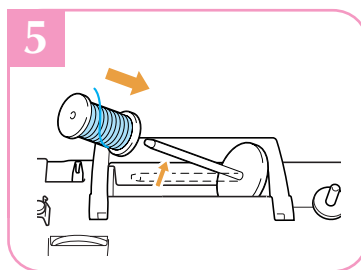
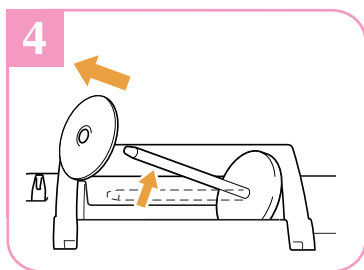
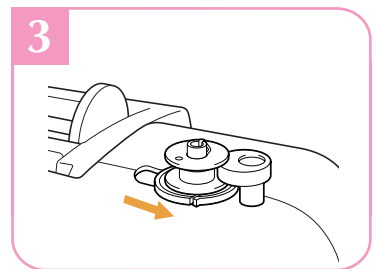
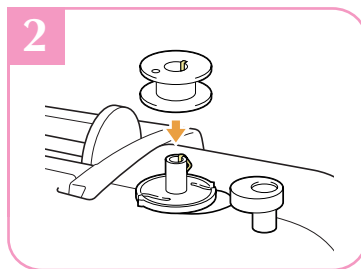
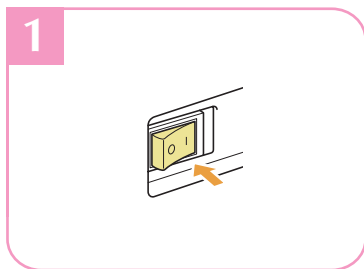
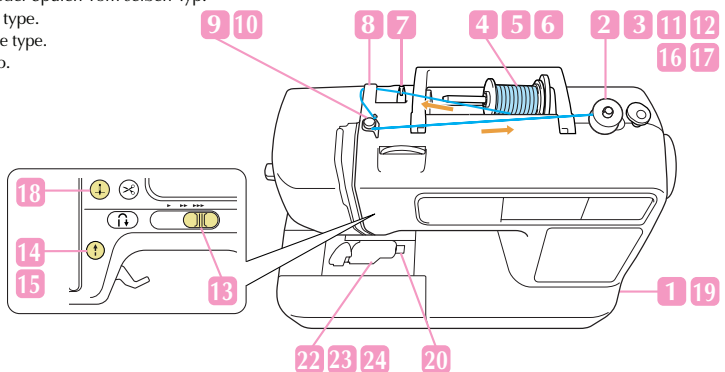
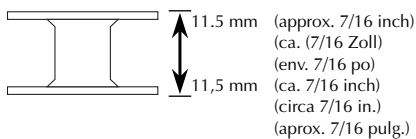

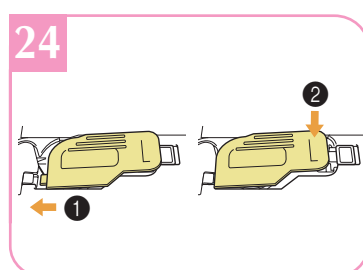
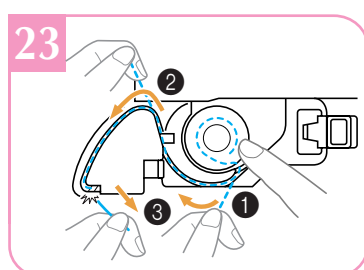
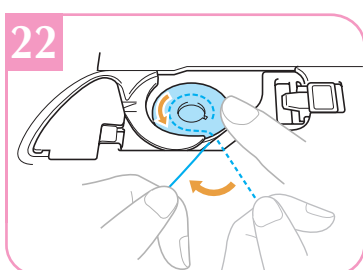
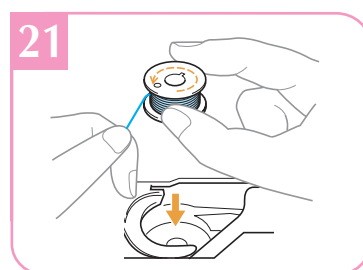
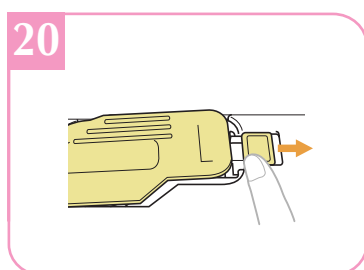
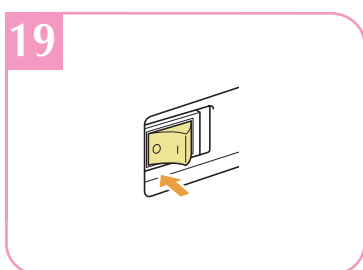
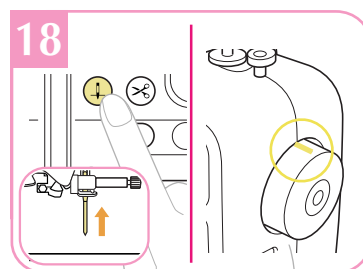
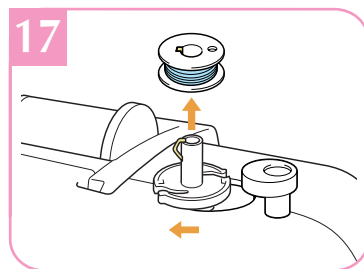
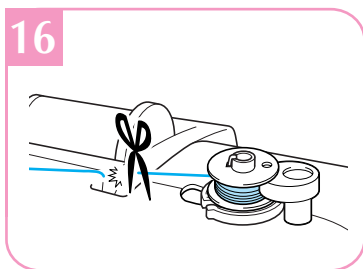
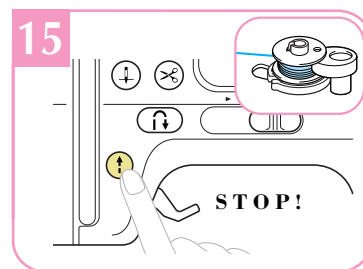
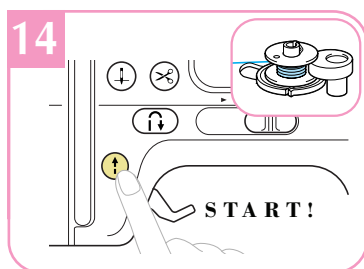
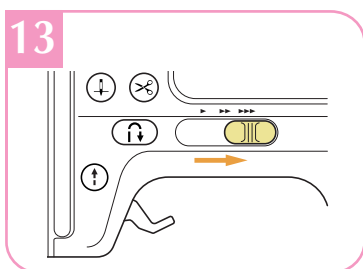
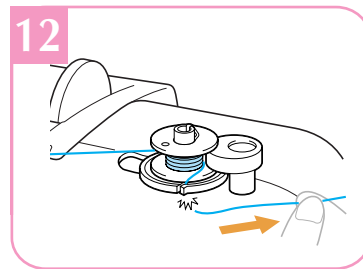
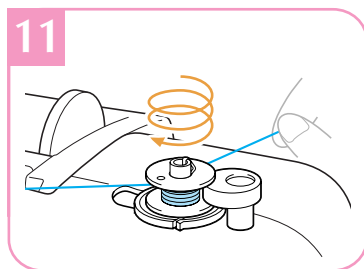
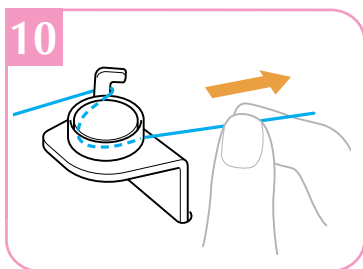

Upper Threading  
 Einfädeln des Oberfadens  
 Enfilage supérieur  
 Inrijgen van de bovendraad  
 Infilatura superiore  
 Hilo superior

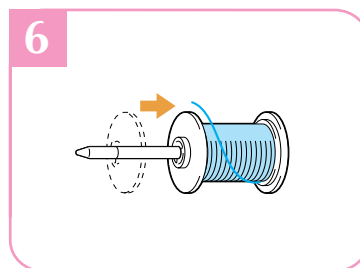
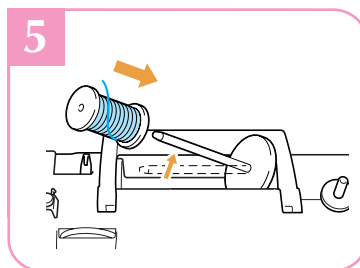
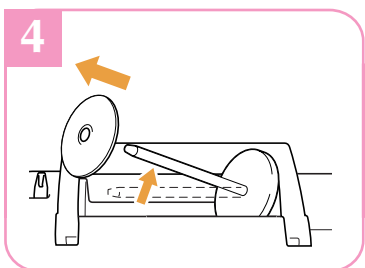
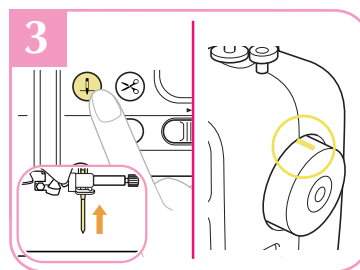
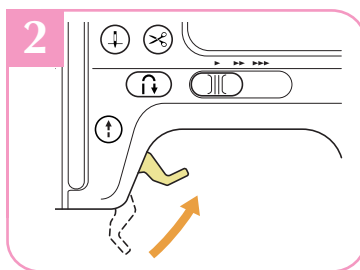
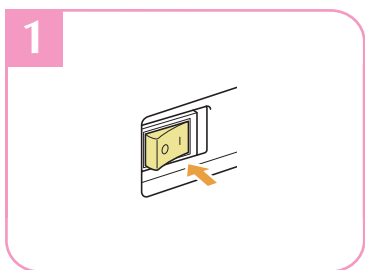
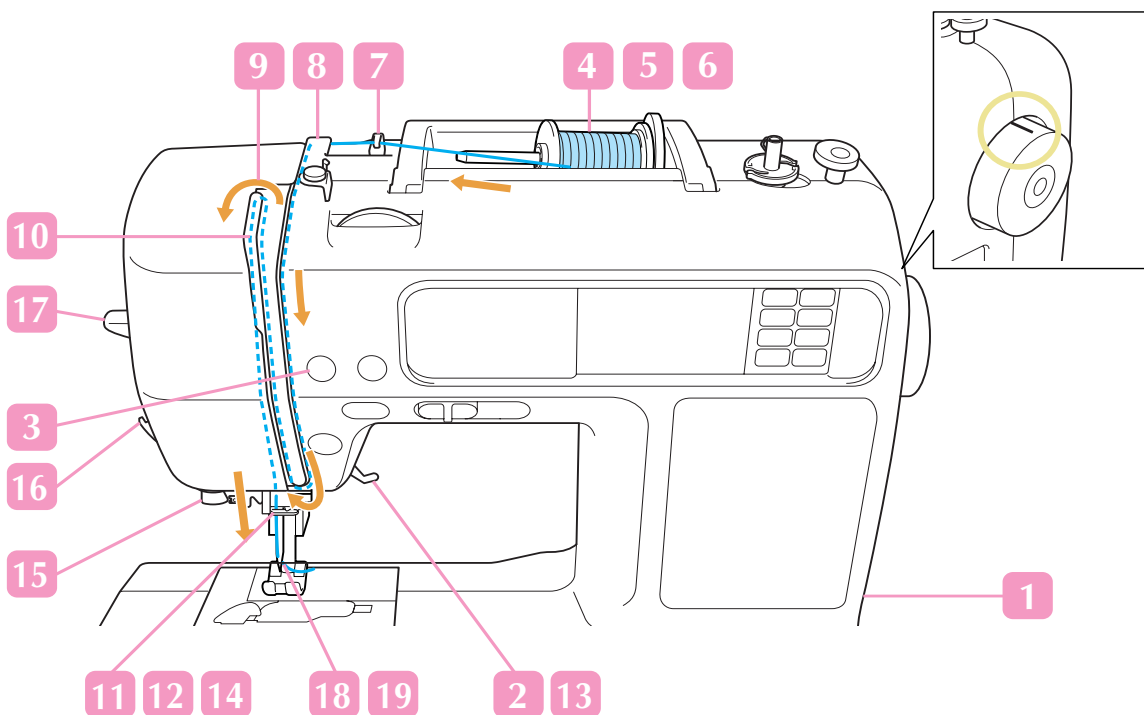



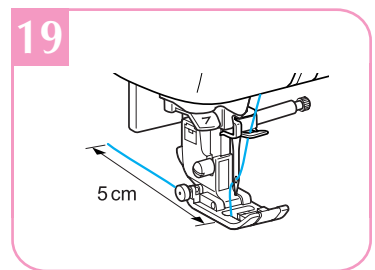
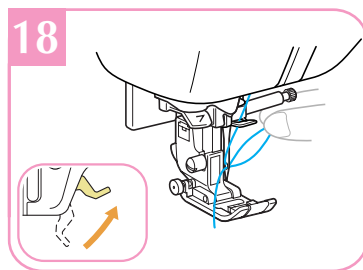
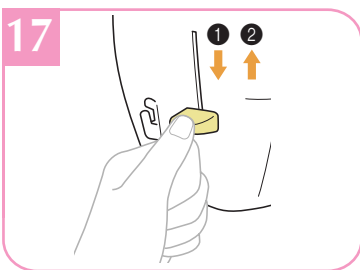
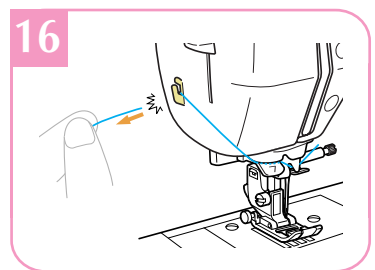
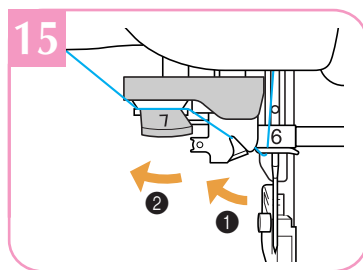
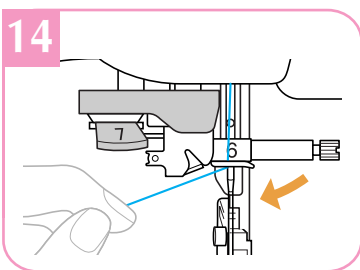
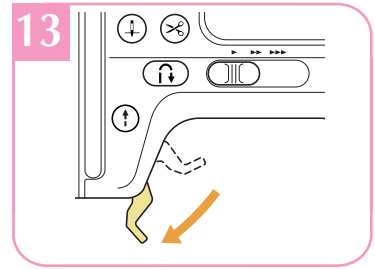
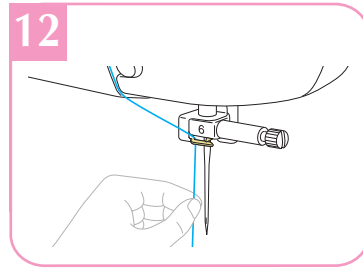
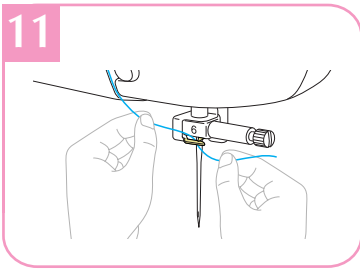
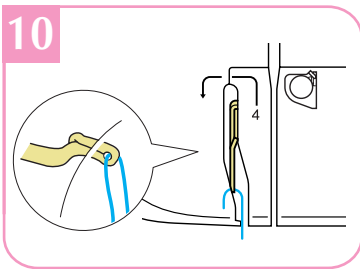
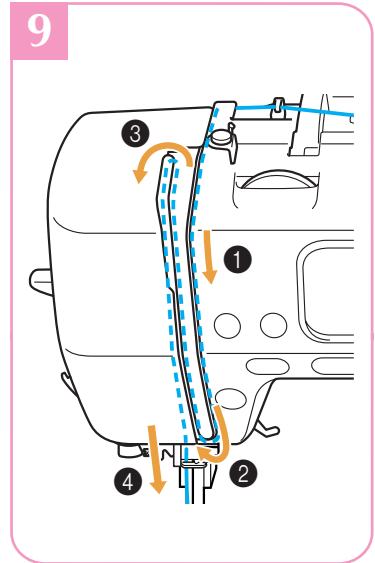
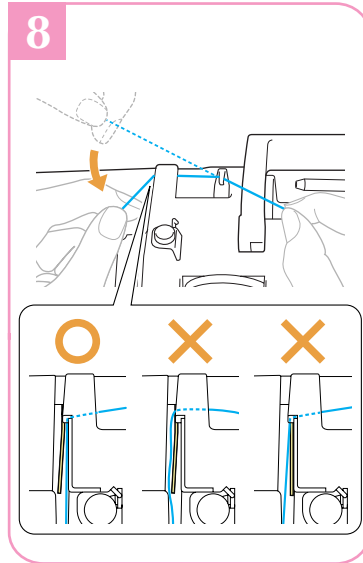
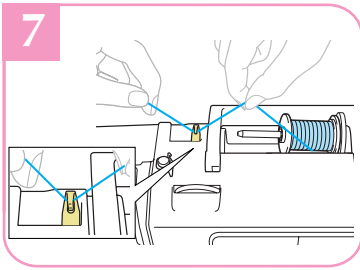

## Selecting Stitch Patterns

### Wahl des Nähmusters

### Sélection des configurations de point

### Kiezen van de steekpatronen

### Selezione degli schemi punto

### Selección de tipos de puntada



- ◆ Utility Stitches
- ◆ Nutzstiche
- ◆ Points utilitaires
- ◆ Naaisteken
- ◆ Punti utili
- ◆ Puntadas utiles

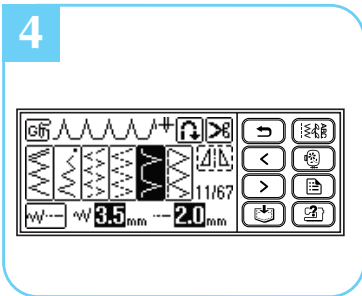
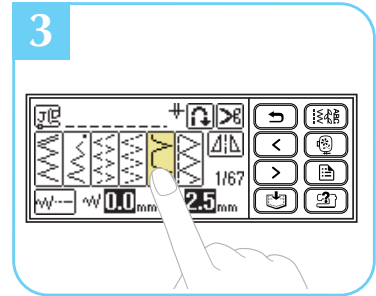
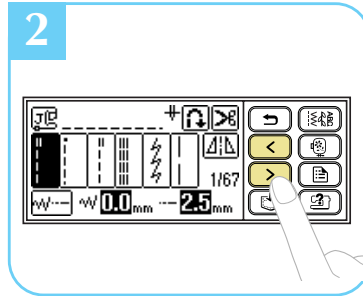
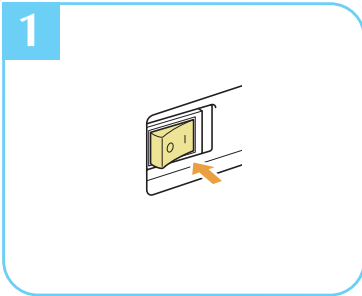

- ◆ Other Stitches
- ◆ Weitere Stiche
- ◆ Autres points
- ◆ Andere steken
- ◆ Altri punti
- ◆ Otras puntadas

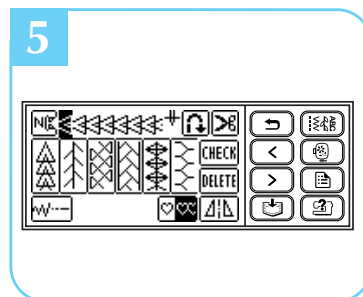
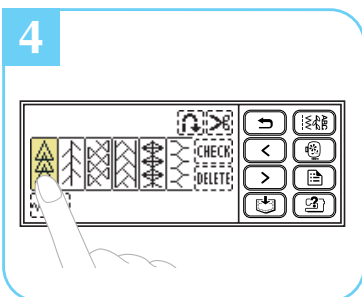
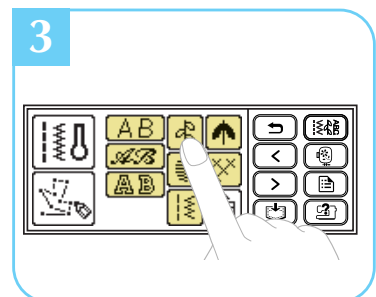
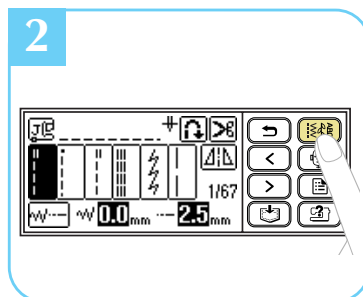
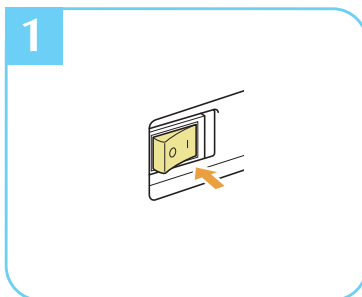

LCD Flow Chart  
Schéma de procédé LCD  
Diagramma di flusso LCD

LCD-Übersichtsdiagramm  
Stroomschema op LCD  
Diagrama de flujo del LCD

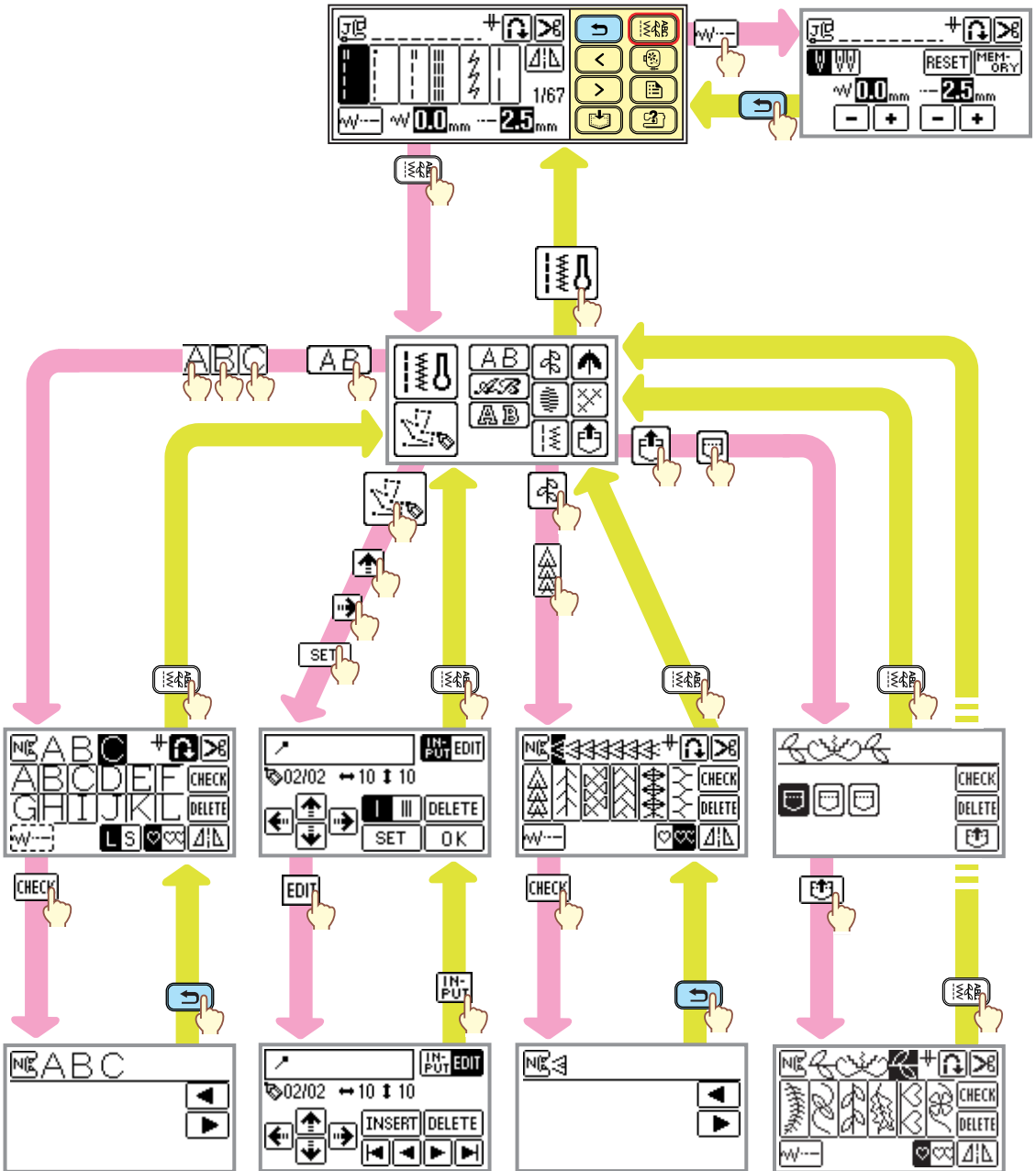

# Summary of Stitch Patterns

## Nähmuster-Übersicht

### Sommaires des motifs de point

### Overzicht van de steekpatronen

### Sommario degli schemi punto

### Resumen de tipos de puntada



#### ◆ Utility Stitches

#### ◆ Nutzstiche

#### ◆ Points utiles

#### ◆ Naaisteken

#### ◆ Punti utili

#### ◆ Puntadas utiles

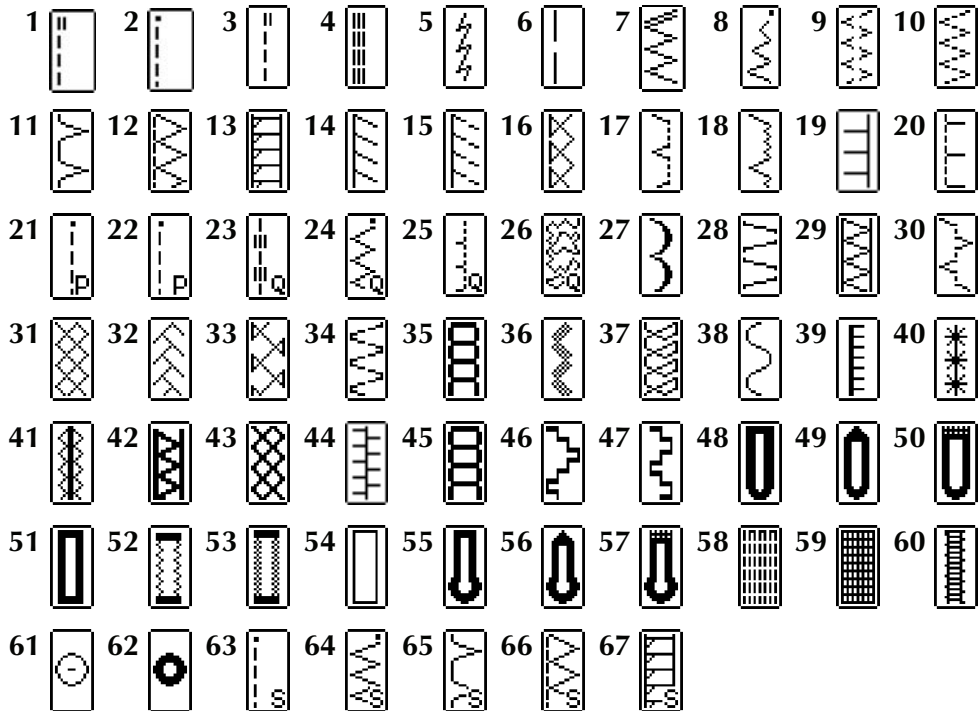

#### ◆ Other Stitches

#### ◆ Weitere Stiche

#### ◆ Autres points

#### ◆ Andere steken

#### ◆ Altri punti

#### ◆ Otras puntadas



#### ■ Decorative stitches

#### ■ Zierstiche

#### ■ Points décoratifs

#### ■ Decoratieve steken

#### ■ Punti decorativi

#### ■ Puntadas decorativas

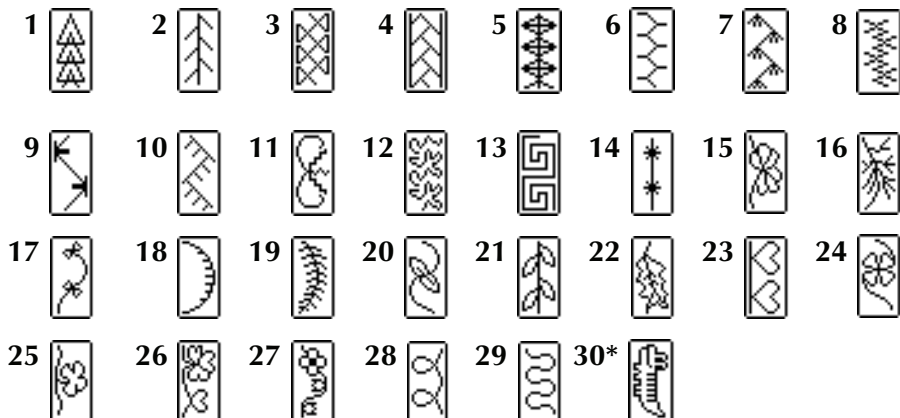

\* Pattern for making adjustment

\* Patroon voor het maken van afstellingen

\* Muster für Einstellungen

\* Schema per eseguire la regolazione

\* Motif pour effectuer un réglage

\* Dibujo para hacer ajustes



■ Satin stitches  
■ Satijnen steken

■ Satinstiche  
■ Punti a raso

■ Points plumetis  
■ Puntadas para satén

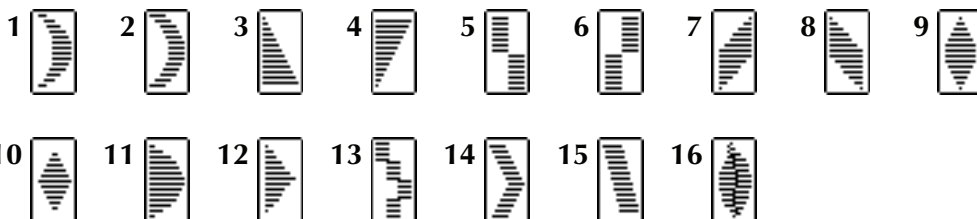

■ Cross-stitches  
■ Kruissteken

■ Kreuzstiche  
■ Punti croce

■ Points croisés  
■ Costura cruzada

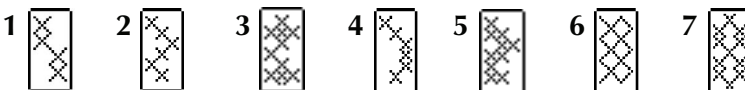

■ Decorative Satin stitches  
■ Decoratieve satijnen steken

■ Satin Zierstiche  
■ Punt decorativi a raso

■ Points plumetis décoratifs  
■ Puntadas decorativas para satén



■ Combined Utility Stitches  
■ Gecombineerde naaisteken

■ Kombinierte Gebrauchsstiche  
■ Punti utili combinati

■ Point utilitaires combinés  
■ Puntadas de utilidad combinadas

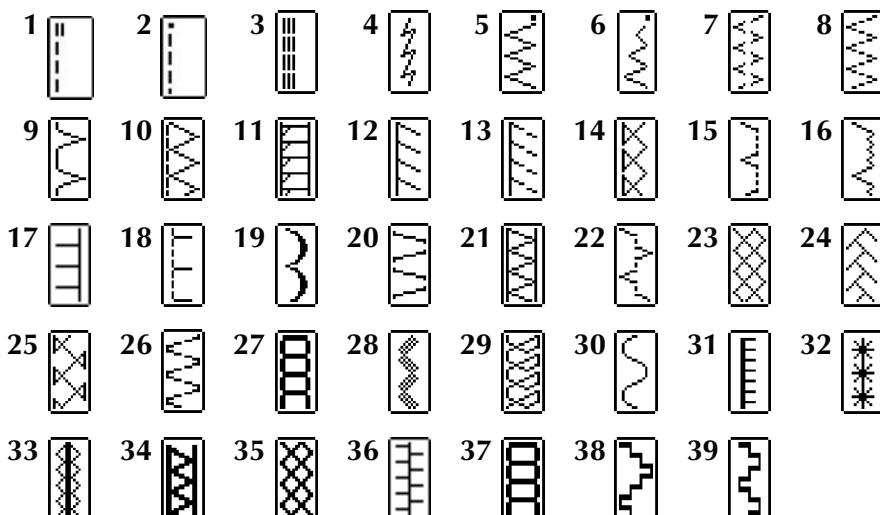

Summary of Stitch Patterns  
 Nähmuster-Übersicht  
 Sommaires des motifs de point  
 Overzicht van de steekpatronen  
 Sommario degli schemi punto  
 Resumen de tipos de puntada

- ◆ Character Stitches      ◆ Buchstabenstiche      ◆ Points caractères
- ◆ Lettersteken            ◆ Punto con caratteri      ◆ Costuras de caracteres

-  ■ Gothic font      ■ Schriftart Gotisch      ■ Police gothique
- type Gothic      ■ carattere gotico      ■ Letra gótica

ABCDEF GHIJKLMNOPQRS  
 TUVWXYZ  
 0123456789  
 &?! - \_ ( ) ' . ,  
 Ä Å Æ Æ Æ Ö Ø Ç Ü ß

-  ■ Script font      ■ Schriftart Script      ■ Police script
- type Script      ■ carattere in corsivo      ■ Letra escritura

*ABCDEF GHI IJKL MN O P QR S*  
*TUVWXYZ*  
*0123456789*  
*&?! - \_ ( ) ' . ,*  
*Ä Å Æ Æ Æ Ö Ø Ç Ü ß*

-  ■ Outline style      ■ Schriftart Umriss      ■ Style contour
- opmaak Contour      ■ stile contorno      ■ Estilo de contorno

ABCDEF GHIJKLMNOPQRS  
 TUVWXYZ  
 0123456789  
 &?! - \_ ( ) ' . ,  
 Ä Å Æ Æ Æ Ö Ø Ç Ü ß

**Preparing to Embroider**  
**Vorbereitung zum Sticken**  
**Préparation de la broderie**  
**Vorbereidingen voor borduren**  
**Preparativi per il ricamo**  
**Preparativos para bordar**

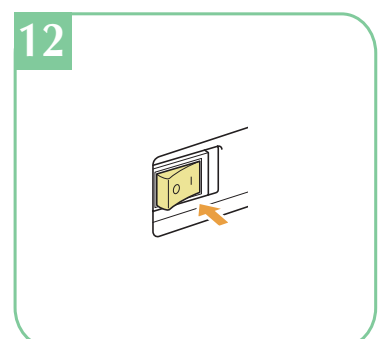
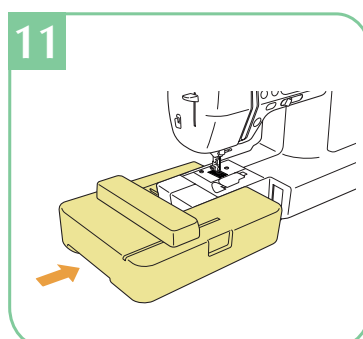
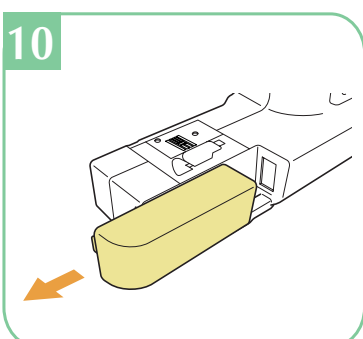
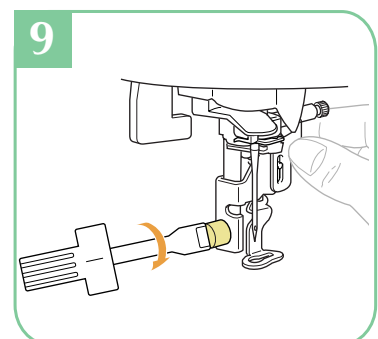
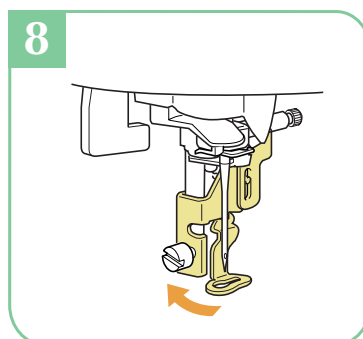
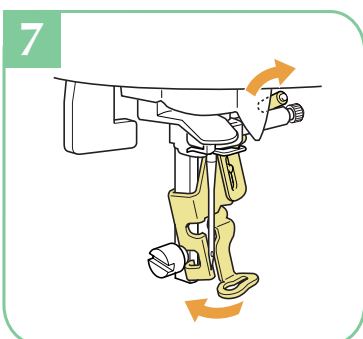
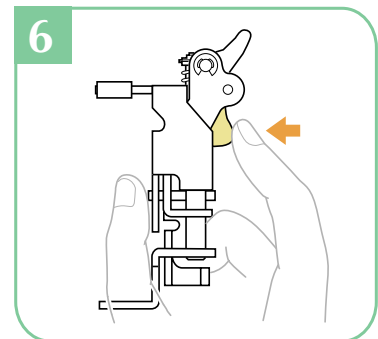
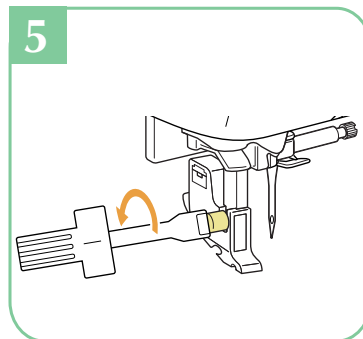
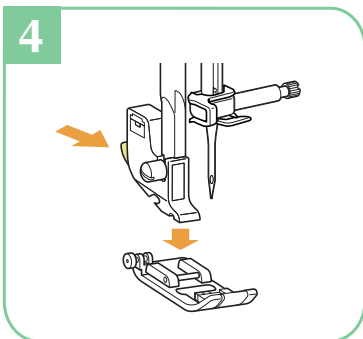
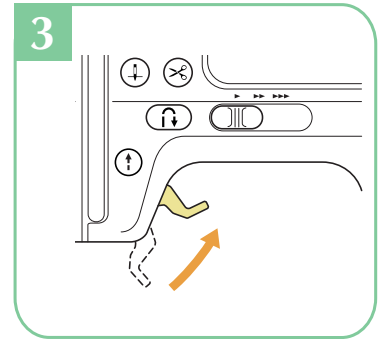
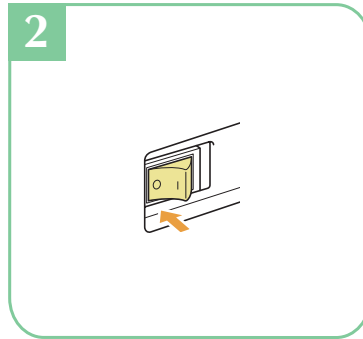
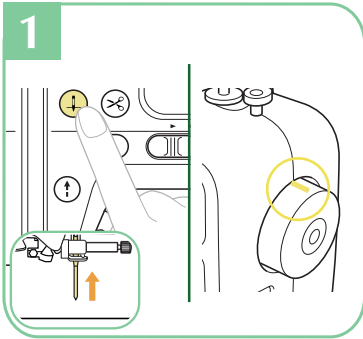

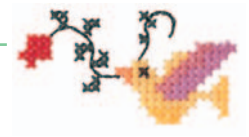

**Preparing to Embroider**  
**Vorbereitung zum Sticken**  
**Préparation de la broderie**  
**Vorbereidingen voor borduren**  
**Preparativi per il ricamo**  
**Preparativos para bordar**

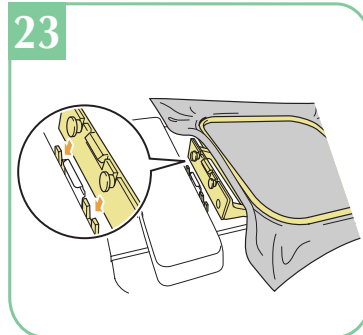
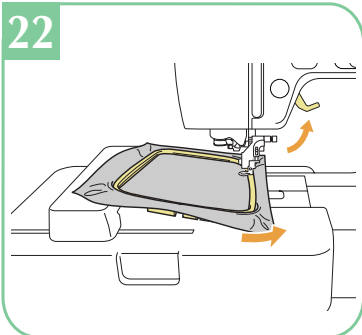
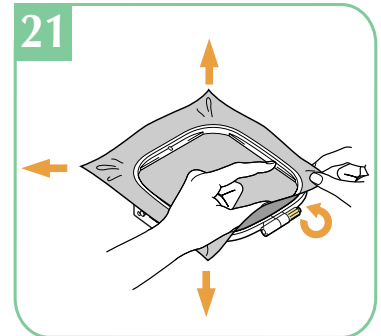
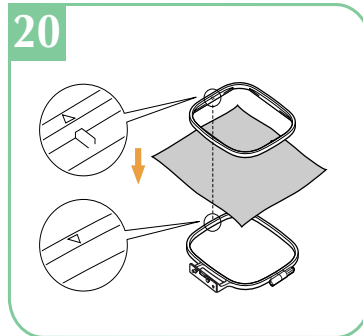
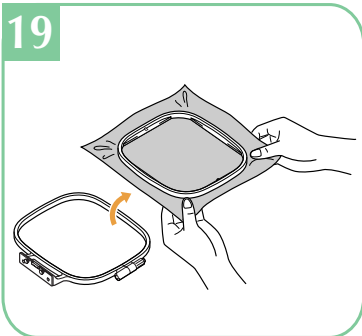
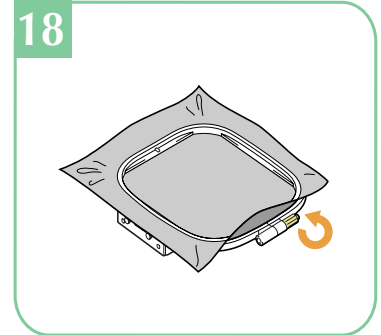
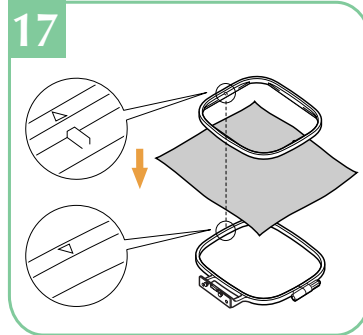
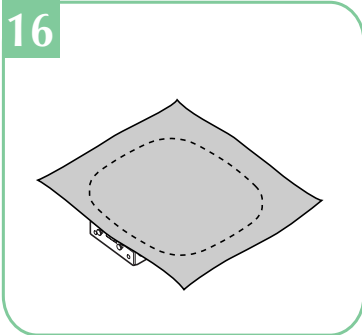
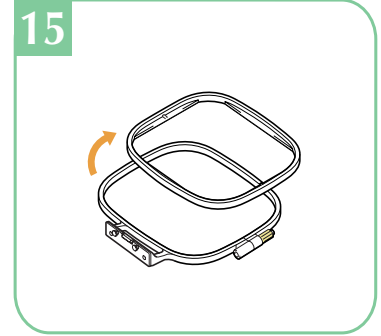
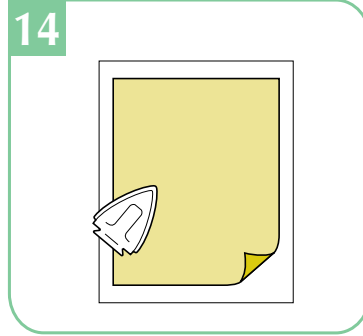
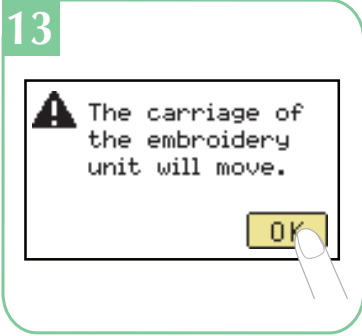



**Selecting Embroidery Patterns**  
**Wählen von Stickmustern**  
**Sélection des motifs de broderie**  
**Kiezen van borduurpatronen**  
**Selezione degli schemi di ricamo**  
**Selección de diseños de bordados**



- ◆ Selecting the built-in patterns
- ◆ Auswahl der gespeicherten Muster
- ◆ Sélection des motifs intégrés
- ◆ Het kiezen van ingebouwde patronen
- ◆ Selezione degli schemi incorporati
- ◆ Selección de los diseños incorporados

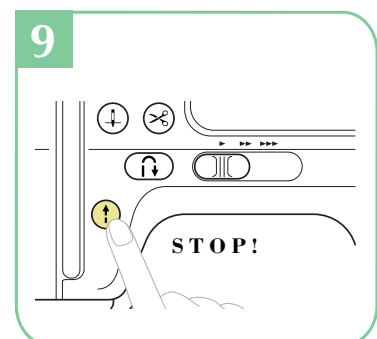
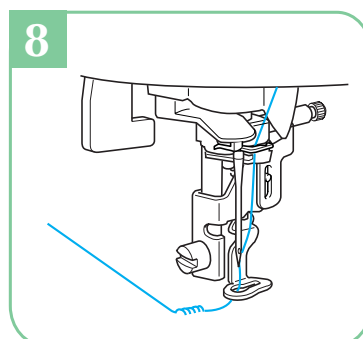
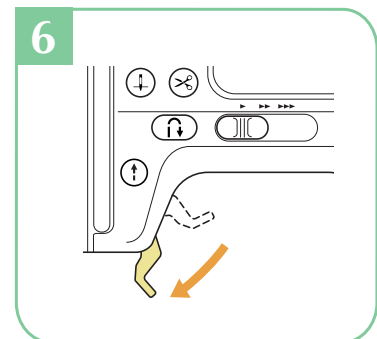
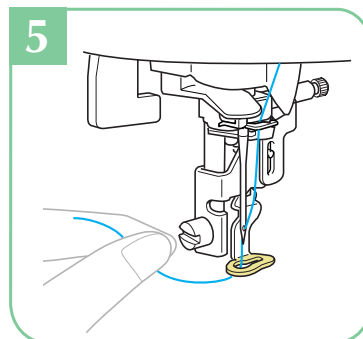
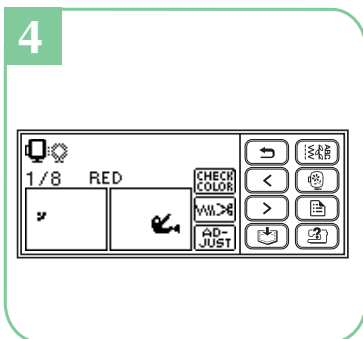
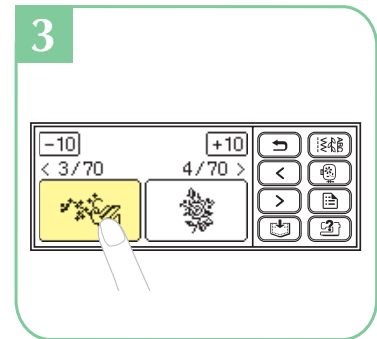
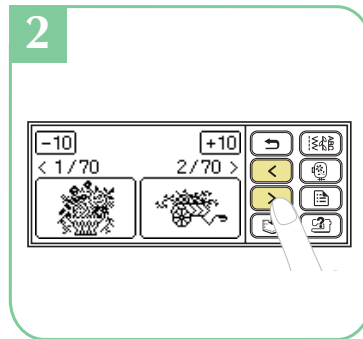
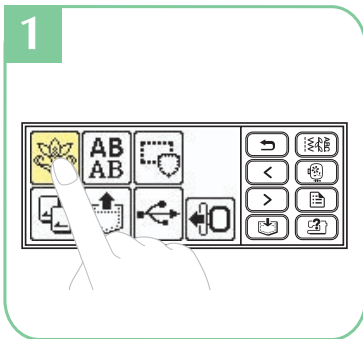

**Selecting Embroidery Patterns**  
**Wählen von Stickmustern**  
**Sélection des motifs de broderie**  
**Kiezen van borduurpatronen**  
**Selezione degli schemi di ricamo**  
**Selección de diseños de bordados**

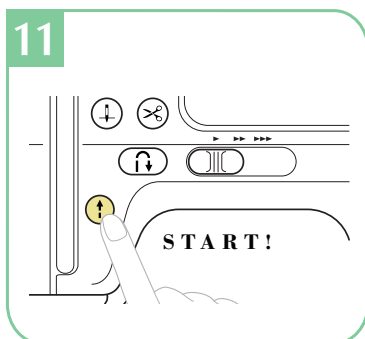
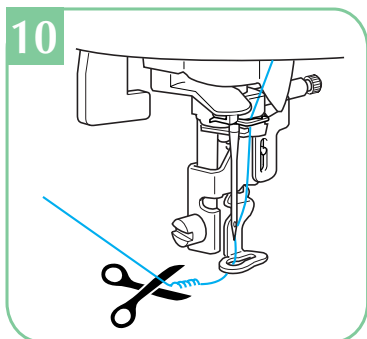

- ◆ Retrieving patterns from a USB flash drive (USB flash memory)
- ◆ Abruf von Mustern von einem USB-Flashlaufwerk (USB-Flashspeicher)
- ◆ Récupération des motifs à partir d'un lecteur flash USB (mémoire flash USB)
- ◆ Het ophalen van patronen vanaf een USB-flashstation (USB-flashgeheugen)
- ◆ Ripristino disegni da un'unità flash USB (memoria flash USB) in corso
- ◆ Recuperación de diseños desde la unidad Flash USB (memoria Flash USB)

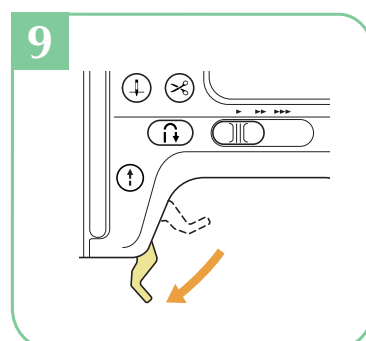
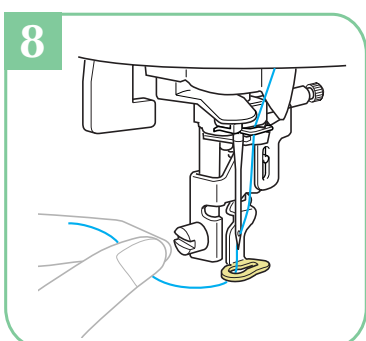
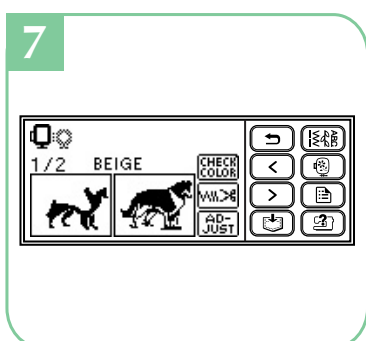
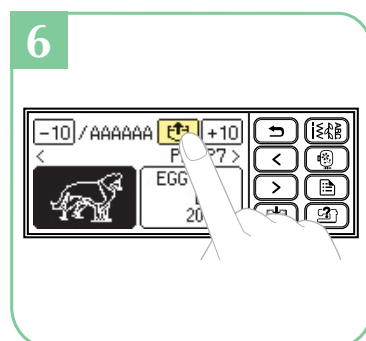
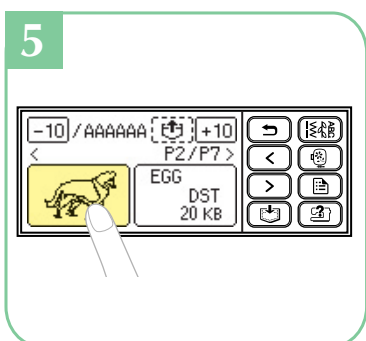
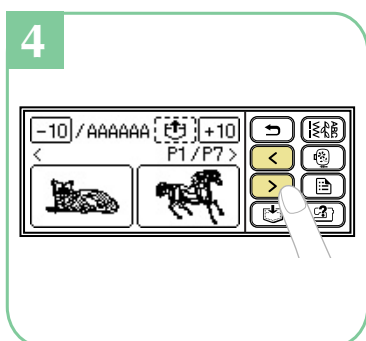
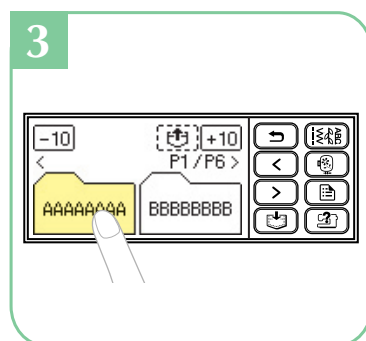
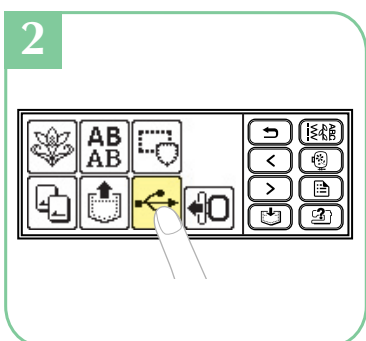
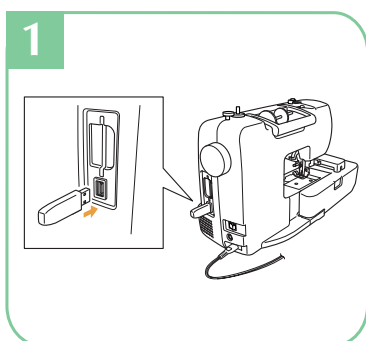

**Selecting Embroidery Patterns**  
**Wählen von Stickmustern**  
**Sélection des motifs de broderie**  
**Kiezen van borduurpatronen**  
**Selezione degli schemi di ricamo**  
**Selección de diseños de bordados**

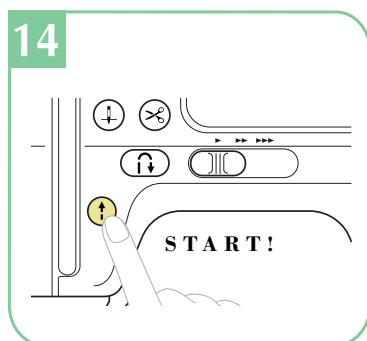
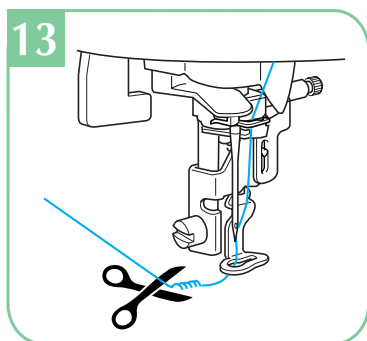
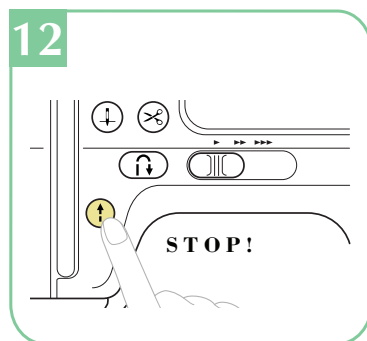
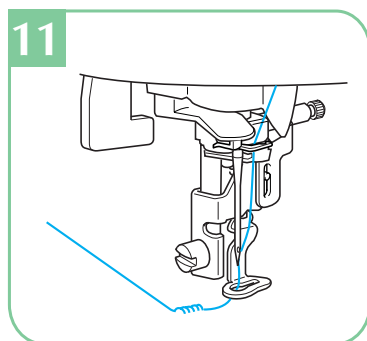
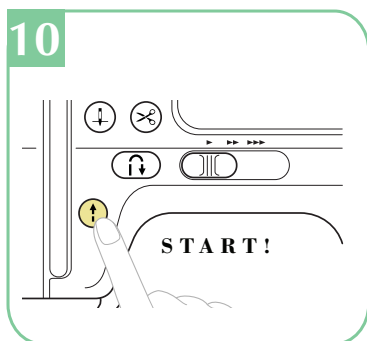

**LCD Flow Chart**  
**Schéma de procédé LCD**  
**Diagramma di flusso LCD**

**LCD-Übersichtsdiagramm**  
**Stroomschema op LCD**  
**Diagrama de flujo del LCD**

- ◆ Embroidery Patterns
- ◆ Borduurpatronen

- ◆ Stickmuster
- ◆ Schemi di ricamo

- ◆ Motifs de broderie
- ◆ Patrones de bordado

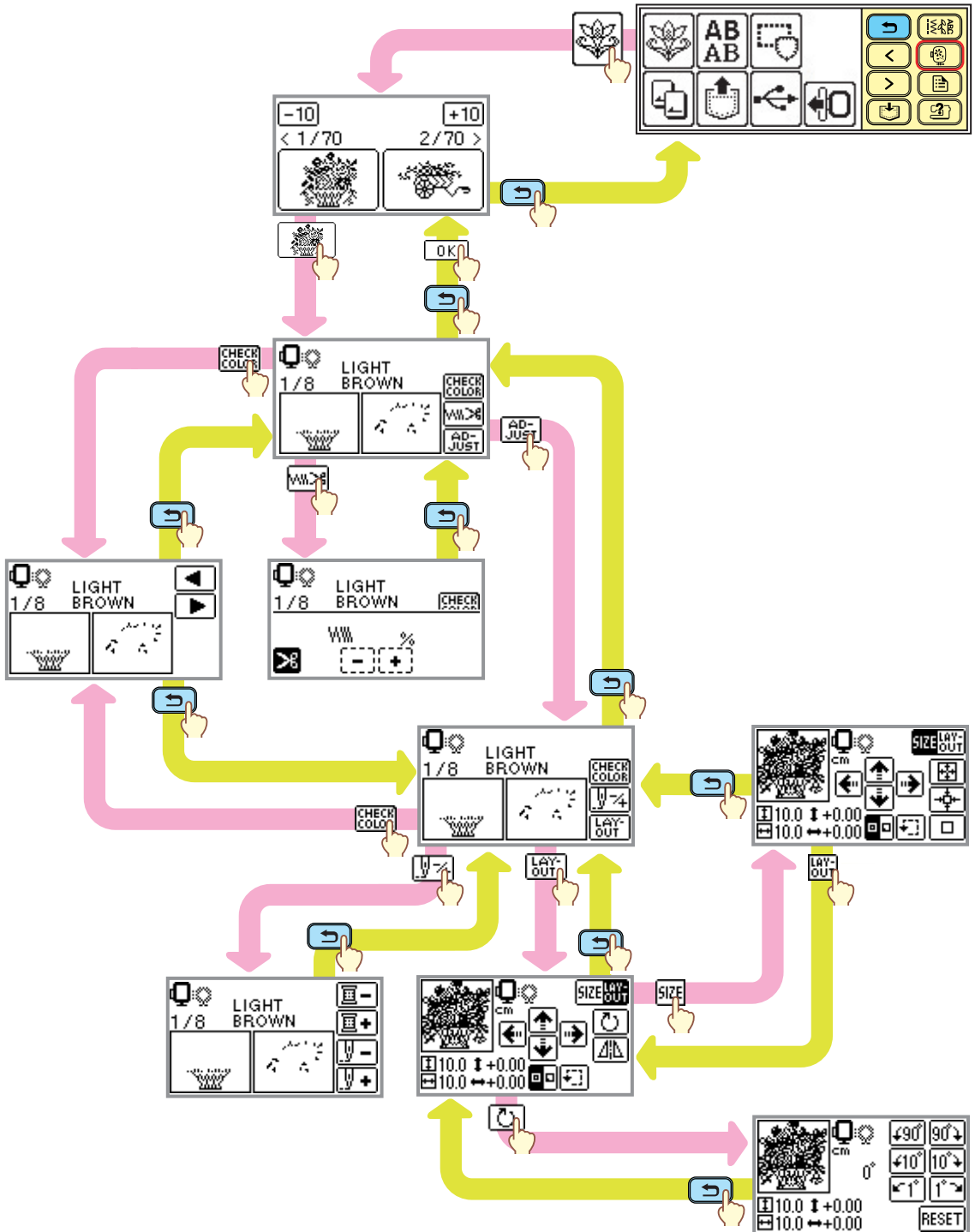



Selecting Embroidery Patterns  
 Sélection des motifs de broderie  
 Selezione degli schemi di ricamo

Wählen von Stickmustern  
 Kiezen van borduurpatronen  
 Selección de diseños de bordados

- ◆ Other Patterns
- ◆ Andere Muster
- ◆ Autres modèles
- ◆ Overige patronen
- ◆ Altre configurazioni
- ◆ Otros patrones

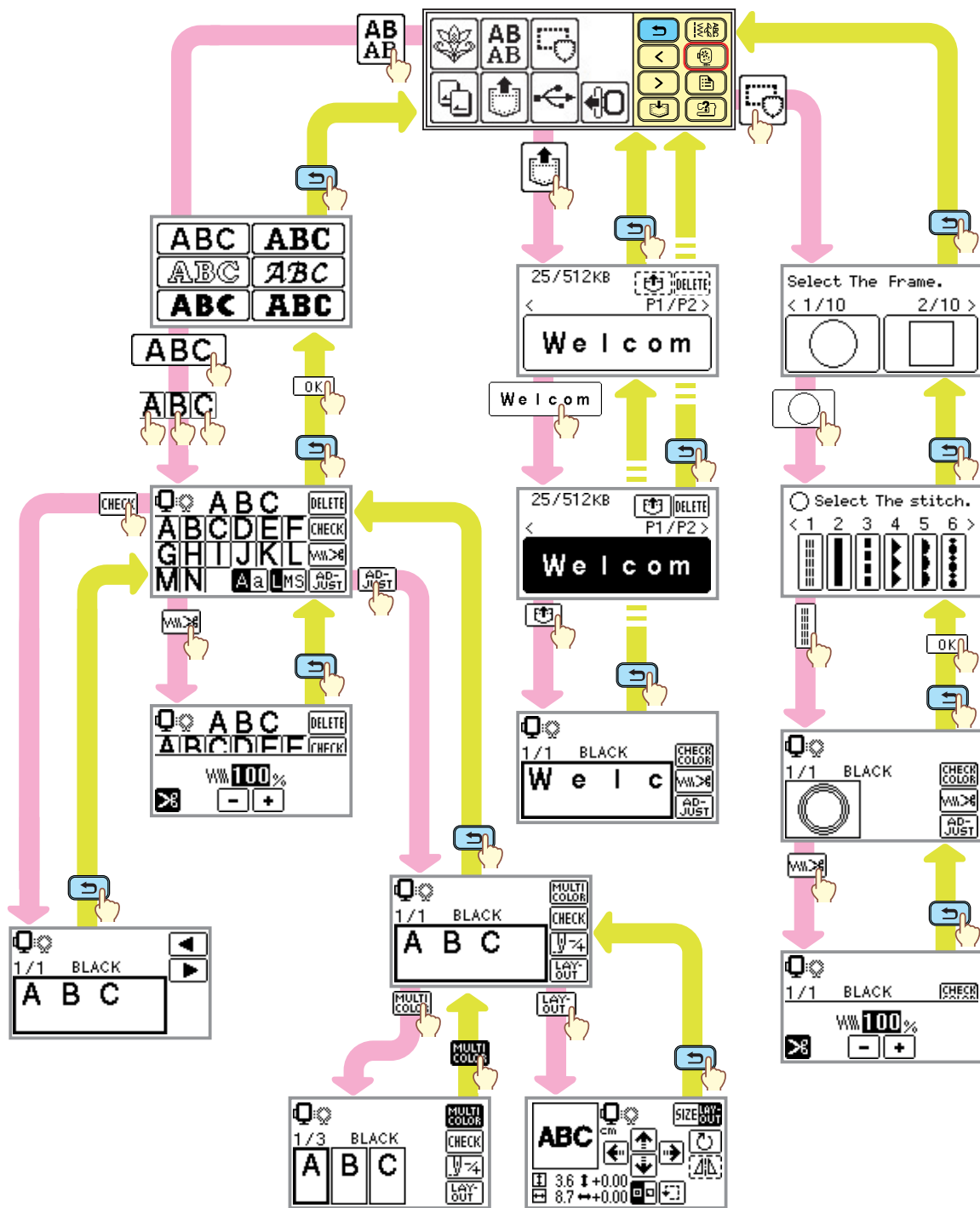

Alphanumeric Character Patterns  
 Alphanumerische Buchstabenmuster  
 Motifs de caractères alphanumériques  
 Patronen met alfanumerieke karakters  
 Schemi dei caratteri alfanumerici  
 Patrón de caracteres alfanumérico



AB  
AB

ABC

A B C D E F G H I J K L M N O P Q R S  
 T U V W X Y Z  
 a b c d e f g h i j k l m n o p q r s  
 t u v w x y z  
 0 1 2 3 4 5 6 7 8 9  
 & ? ! - \_ ( ) ' . , /  
 Ä Å Æ Æ Ñ Ö Ø Ç Ü  
 ä à â â æ ë è é ê ñ ö ò ø ì ç ü ù ß

ABC

A B C D E F G H I J K L M N O P Q R S  
 T U V W X Y Z  
 a b c d e f g h i j k l m n o p q r s  
 t u v w x y z  
 0 1 2 3 4 5 6 7 8 9  
 & ? ! - \_ ( ) ' . , /  
 Ä Å Æ Æ Ñ ö Ø Ç Ü  
 ä à â â æ ë è é ê ñ ö ò ø ì ç ü ù ß

ABC

A B C D E F G H I J K L M N O P Q R S  
 T U V W X Y Z  
 a b c d e f g h i j k l m n o p q r s  
 t u v w x y z  
 0 1 2 3 4 5 6 7 8 9  
 & ? ! - \_ ( ) ' . , /  
 Ä Å Æ Æ Ñ ö Ø Ç Ü  
 ä à â â æ ë è é ê ñ ö ò ø ì ç ü ù ß



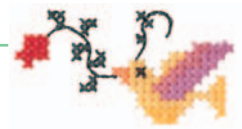

**ABC**

A B C D E F G H I J K L M N O P Q R S  
T U V W X Y Z  
a b c d e f g h i j k l m n o p q r s  
t u v w x y z  
0 1 2 3 4 5 6 7 8 9  
& ? ! - \_ ( ) ' . , /  
Ä Å Â Æ Ñ Ö Ø Ç Ü  
ä å â â æ ë è é ê ñ ö ò ø ì ç ü ù ß

**ABC**

A B C D E F G H I J K L M N O P Q R S  
T U V W X Y Z  
a b c d e f g h i j k l m n o p q r s  
t u v w x y z  
0 1 2 3 4 5 6 7 8 9  
& ? ! - \_ ( ) ' . , /  
Ä Å Â Æ Ñ Ö Ø Ç Ü  
ä å â â æ ë è é ê ñ ö ò ø ì ç ü ù ß

**ABC**

A B C D E F G H I J K L M N O P Q R S  
T U V W X Y Z  
a b c d e f g h i j k l m n o p q r s  
t u v w x y z  
0 1 2 3 4 5 6 7 8 9  
& ? ! - \_ ( ) ' . , /  
Ä Å Â Æ Ñ Ö Ø Ç Ü  
ä å â â æ ë è é ê ñ ö ò ø ì ç ü ù ß



**Frame Patterns**  
**Rahmenmuster**  
**Motifs cadres**  
**Kaderpatronen**  
**Motivi a cornicetta**  
**Costuras de encuadre**



- Frame shapes    ■ Rahmen-Formen    ■ Formes de cadre
- Raamvormen    ■ Forme cornici    ■ Tipos de bastidores

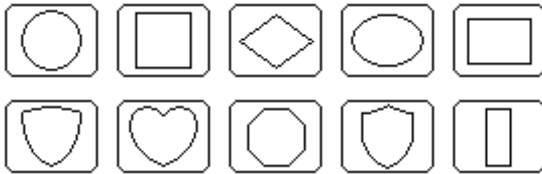



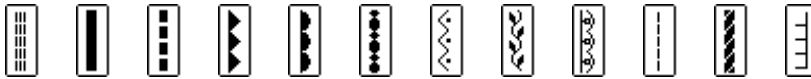

- Stitches    ■ Stiche    ■ Points
- Steken    ■ Punti    ■ Puntadas



- Sample at actual size    ■ Muster in Originalgröße    ■ Exemple en vraie grandeur
- Voorbeeld op ware grootte    ■ Campione in dimensioni reali    ■ Muestra en tamaño real

Sample combining  and  / Muster mit Kombination von  und  /

Exemple combinant  et  / Voorbeeld waarin  en  zijn gecombineerd /

Campione che combina  e  / Muestra combinando  y 

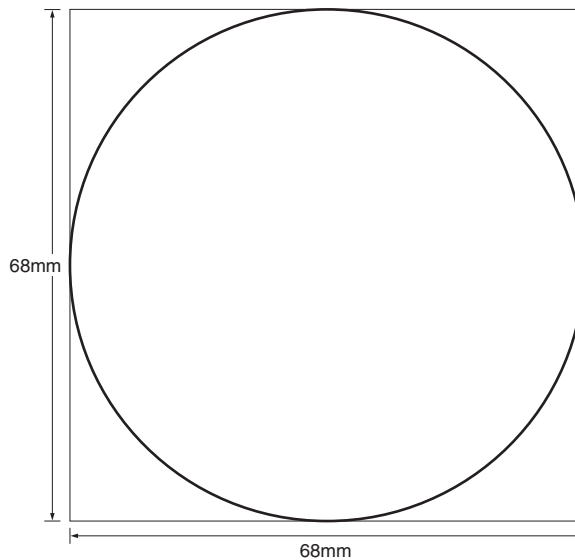

# Embroidery Pattern Color Change Table

## Stickmuster-Farbtabelle

### Tableau de changement de couleur des motifs de broderie

### Kleurwijzigingstabel voor de borduurpatronen

### Tabella di cambiamento colori degli schemi di ricamo

### Tabla de cambio de color para patrones de bordado



Order to embroider  
Stickvorgang  
Séquence pour broder  
Borduurvolgorde  
Sequenza operazioni di ricamo  
Orden para el bordador



No.1

25 min

- 1 (255)
- 2 (463)
- 3 (444)
- 4 (155)
- 5 (024)
- 6 (224)
- 7 (334)
- 8 (485)

Time required for embroidering  
Zeitaufwand beim Sticken  
Durée requise pour broder  
Tijd benodigd voor het borduren  
Tempo di ricamo necessario  
Tiempo requerido para el bordado

Embroidery thread color number  
Stickgarn-Farbnúmer  
Número de couleur du fil de broderie  
Kleurnummer borduurdraad  
Número colori filo per ricamo  
Número de color del hilo de bordado

10.0cm ↔ 10.0cm

COUNTRY

Embroidery thread color  
Stickgarnfarbe  
Couleur du fil de broderie  
Kleur borduurdraad  
Colore filo ricamo  
Color del hilo de bordado

Embroidery size  
Größe der Stickerei  
Taille de la broderie  
Borduurgrootte  
Dimensioni del ricamo  
Tecla de tamaño



No.7

5 min

- 1 (476)
- 2 (126)
- 3 (024)
- 4 (122)

8.1cm ↔ 1.6cm

COUNTRY

No.8

23 min

- 1 (017)
- 2 (019)
- 3 (070)
- 4 (810)
- 5 (001)
- 6 (019)
- 7 (070)

9.4cm ↔ 9.4cm



No.2

10 min

- 1 (334)
- 2 (322)
- 3 (335)
- 4 (336)
- 5 (473)
- 6 (354)
- 7 (485)
- 8 (148)
- 9 (255)

4.8cm ↔ 9.4cm

COUNTRY

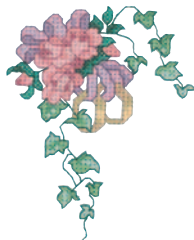

No.5

21 min

- 1 (126)
- 2 (155)
- 3 (152)
- 4 (122)
- 5 (625)
- 6 (624)
- 7 (623)
- 8 (476)
- 9 (485)
- 10 (463)
- 11 (461)
- 12 (446)
- 13 (444)
- 14 (354)
- 15 (404)
- 16 (370)
- 17 (126)
- 18 (636)
- 19 (224)
- 20 (476)

9.4cm ↔ 7.6cm

COUNTRY



No.3

3 min

- 1 (149)
- 2 (370)
- 3 (334)
- 4 (133)
- 5 (624)
- 6 (322)
- 7 (717)
- 8 (485)

2.8cm ↔ 5.4cm

COUNTRY



No.9

3 min

- 1 (019)
- 2 (017)
- 3 (070)

1.6cm ↔ 9.0cm



No.4

5 min

- 1 (024)
- 2 (152)
- 3 (444)
- 4 (473)
- 5 (623)

5.3cm ↔ 4.0cm

COUNTRY

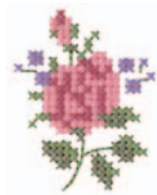

No.6

6 min

- 1 (588)
- 2 (000)
- 3 (126)
- 4 (024)
- 5 (255)
- 6 (354)
- 7 (586)

3.4cm ↔ 8.1cm

COUNTRY



No.11

21 min

- 1 (513)
- 2 (534)
- 3 (612)
- 4 (620)
- 5 (070)
- 6 (010)

9.6cm ↔ 8.6cm

No.12



17 min

- 1 (502)
- 2 (612)
- 3 (070)
- 4 (010)
- 5 (007)

↕7.4cm ↔ 7.4cm

No.17



6 min

- 1 (070)
- 2 (079)

↕6.9cm ↔ 6.3cm

No.23



1 min

- 1 (612)

↕4.7cm ↔ 8.5cm

No.13



9 min

- 1 (502)
- 2 (010)
- 3 (208)

↕7.3cm ↔ 6.0cm

No.18



2 min

- 1 (124)

↕2.7cm ↔ 3.0cm

No.24



1 min

- 1 (612)

↕5.8cm ↔ 9.4cm

No.19



9 min

- 1 (017)

↕5.9cm ↔ 8.3cm

No.25



3 min

- 1 (019)
- 2 (807)

↕4.9cm ↔ 6.2cm

No.14



20 min

- 1 (502)
- 2 (010)
- 3 (208)
- 4 (810)
- 5 (086)
- 6 (017)
- 7 (085)
- 8 (328)

↕9.6cm ↔ 6.7cm

No.20



8 min

- 1 (126)

↕9.2cm ↔ 8.5cm

COUNTRY

No.26

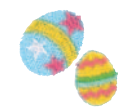

5 min

- 1 (017)
- 2 (205)
- 3 (513)
- 4 (086)
- 5 (001)
- 6 (017)

↕3.2cm ↔ 3.4cm

No.15



4 min

- 1 (534)
- 2 (800)
- 3 (307)
- 4 (030)

↕2.7cm ↔ 4.1cm

No.21



6 min

- 1 (126)

↕7.8cm ↔ 9.3cm

COUNTRY

No.27

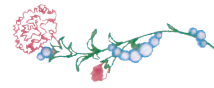

4 min

- 1 (807)
- 2 (515)
- 3 (001)
- 4 (070)

↕3.0cm ↔ 7.9cm

No.16



10 min

- 1 (534)
- 2 (800)
- 3 (070)
- 4 (307)
- 5 (019)
- 6 (030)

↕8.9cm ↔ 9.0cm

No.22



2 min

- 1 (612)

↕9.6cm ↔ 9.4cm

No.28



10 min

- 1 (208)
- 2 (205)
- 3 (900)
- 4 (620)
- 5 (001)
- 6 (515)

↕5.0cm ↔ 4.1cm

No.29



4 min

- 1 (337)
- 2 (030)
- 3 (058)

↕2.5cm ↔ 2.5cm



## Embroidery Pattern Color Change Table

### Stickmuster-Farbtabelle

### Tableau de changement de couleur des motifs de broderie

### Kleurwijzigingstabel voor de borduurpatronen

### Tabella di cambiamento colori degli schemi di ricamo

### Tabla de cambio de color para patrones de bordado

No.30

11 min

- 1 (800)
- 2 (007)
- 3 (307)
- 4 (399)
- 5 (900)
- 6 (017)
- 7 (001)
- 8 (800)

↓5.6cm ↔ 9.0cm

No.31

5 min

- 1 (800)
- 2 (515)
- 3 (017)
- 4 (124)
- 5 (206)

↓3.7cm ↔ 3.6cm

No.32

9 min

- 1 (586)
- 2 (025)
- 3 (473)
- 4 (242)
- 5 (224)
- 6 (255)
- 7 (747)

↓5.0cm ↔ 5.0cm

No.33

20 min

- 1 (513)
- 2 (001)
- 3 (323)
- 4 (800)
- 5 (017)
- 6 (810)
- 7 (900)
- 8 (513)
- 9 (001)
- 10 (323)
- 11 (019)
- 12 (070)
- 13 (900)
- 14 (058)
- 15 (502)
- 16 (704)
- 17 (900)

↓9.6cm ↔ 6.5cm

COUNTRY

No.34

3 min

- 1 (001)
- 2 (307)
- 3 (707)

↓2.6cm ↔ 2.4cm

No.35

5 min

- 1 (001)
- 2 (323)
- 3 (010)
- 4 (900)

↓3.4cm ↔ 3.8cm

No.36

5 min

- 1 (001)
- 2 (843)
- 3 (707)
- 4 (900)

↓4.0cm ↔ 2.7cm

No.37

3 min

- 1 (001)
- 2 (405)
- 3 (017)
- 4 (800)

↓3.2cm ↔ 3.3cm

No.38

1 min

- 1 (800)
- 2 (017)
- 3 (339)

↓1.6cm ↔ 2.5cm

No.39

3 min

- 1 (704)

↓2.3cm ↔ 3.0cm

★ No.40

3 min

- 1 (107)
- 2 (107)
- 3 (107)
- 4 (328)

↓4.9cm ↔ 4.8cm

No.41

5 min

- 1 (800)
- 2 (205)
- 3 (001)
- 4 (507)
- 5 (900)

↓2.4cm ↔ 5.7cm

No.42

2 min

- 1 (205)
- 2 (405)
- 3 (507)
- 4 (800)
- 5 (900)

↓2.4cm ↔ 5.8cm

★ No.43

7 min

- 1 (019)
- 2 (019)
- 3 (019)
- 4 (205)
- 5 (507)
- 6 (007)
- 7 (900)

↓5.6cm ↔ 5.7cm

★ No.44

17 min

- 1 (800)
- 2 (800)
- 3 (800)
- 4 (019)
- 5 (800)
- 6 (513)
- 7 (124)
- 8 (085)
- 9 (086)

↓6.2cm ↔ 6.2cm

- ★ Refer to the operation manual for the sewing machine for details on how to embroider appliqués.
- ★ Für Einzelheiten zum Sticken der Applikationen wird auf die Bedienungsanleitung der Nähmaschine verwiesen.
- ★ Se reporter au mode d'emploi de la machine à coudre pour la façon de broder les appliqués.
- ★ Zie de bedieningshandleiding van de naaimachine voor nadere bijzonderheden betreffende het borduren van de appliqués.
- ★ Per istruzioni dettagliate sul ricamo delle applique consultare il manuale d'istruzioni della macchina per cucire.
- ★ Consulte el manual de instrucciones de la máquina de coser para los detalles sobre cómo bordar los apliques.

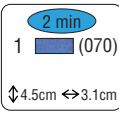

No.45    
↓3.1cm ↔3.9cm

No.54    
↓4.5cm ↔3.1cm

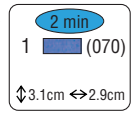
No.63    
↓3.1cm ↔2.9cm

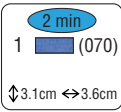
No.46    
↓3.1cm ↔3.6cm

No.55    
↓3.1cm ↔4.0cm

No.64    
↓3.4cm ↔3.4cm

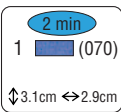
No.47    
↓3.1cm ↔2.9cm

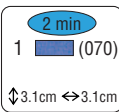
No.56    
↓3.1cm ↔3.1cm

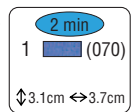
No.65    
↓3.1cm ↔3.7cm

No.48    
↓3.1cm ↔3.1cm

No.57    
↓3.1cm ↔4.6cm

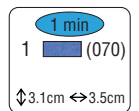
No.66    
↓3.1cm ↔3.5cm

No.49    
↓3.1cm ↔2.8cm

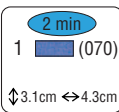
No.58    
↓3.1cm ↔4.3cm

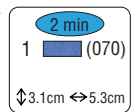
No.67    
↓3.1cm ↔5.3cm

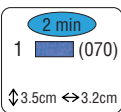
No.50    
↓3.5cm ↔3.2cm

No.59    
↓3.1cm ↔2.6cm

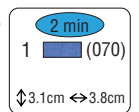
No.68    
↓3.1cm ↔3.8cm

No.51    
↓3.1cm ↔2.4cm

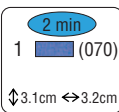
No.60    
↓3.1cm ↔3.2cm

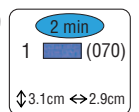
No.69    
↓3.1cm ↔2.9cm

No.52    
↓3.2cm ↔4.2cm

No.61    
↓3.1cm ↔2.6cm

No.70    
↓4.5cm ↔3.3cm

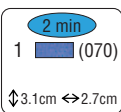
No.53    
↓3.1cm ↔2.7cm

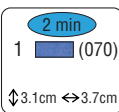
No.62    
↓3.1cm ↔3.7cm



ABC  
KPK  
WWW



# Color Thread Conversion Chart

## Stickgarn-Farbtabelle

## Tableau de conversion des fils de couleur

## Omzettingstabel voor kleurgaren

## Tabella di conversione dei fili colorati

## Tabla de conversión de hilos de color



	Color Name	Embroidery	Country	Madeira Polyneon	Madeira Rayon	Sulky Rayon	R.A. Polyester
1	Black / Schwarz / Noir / Zwart / Nero / Negro	900	100	1800	1000	1005	5596
2	White / Weiss / Blanc / Wit / Bianco / Blanco	001	000	1801	1002	1001	5597
3	Red / Rot / Rouge / Rood / Rosso / Rojo	800	149	1637	1037	1037	5678
4	Pink / Rosa / Rose / Rose / Rosa / Rosado	085	155	1921	1108	1224	5523
5	Deep Rose / Tiefrot / Rose foncé / Roserood / Rosa Intenso / Rosa Intenso	086	024	1721	1117	1154	9168
6	Flesh Pink / Fleisch Farben / Rose chair / Lichtrose / Rosa Carne / Rosa Claro	124	152	1915	1015	1064	5677
7	Dark Fuchsia / Dunkel Violett / Fuchsia foncé / Donker Fuchsia Paars / Fuchsia Scuro / Fucsia Oscuro	107	126	1984	1383	1533	5804
8	Vermillion / Zinnober Rot / Vermillon / Vermil joen / Rosso Vermiglio / Bermellon	030	148	1779	1179	1184	9023
9	Carmine / Karminrot / Carmin / Karmijn / Rosso Carminio / Carmin	807	158	1986	1081	1511	5561
10	Royal Purple / Königs Purpur / Pourpre royal / Dieppaars / Rosso-Violaceo / Violeta Real	869	636	1788	1188	1192	5681
11	Magenta / Magenta / Magenta / Magenta / Magenta	620	625	1710	1319	1191	5592
12	Salmon Pink / Lachsrosa / Rose saumon / Zalmrose / Rosa Salmore / Rosa Salmon	079	122	1816	1317	1225	5773
13	Amber Red / Bern Steinrot / Rouge ambre / Amber Rood / Rosso Ambra / Rojo Ambar	333	212	1942	1341	1119	5591
14	Lemon Yellow / Zitronen Gelb / Jaune citron / Citro Engeel / Giallo Limone / Amarillo Limon	202	342	1623	1023	1067	5625
15	Yellow / Gelb / Jaune / Geel / Giallo / Amarillo	205	043	1980	1068	1187	5860
16	Harvest Gold / Erntegold / Or ble / Oogst Kleurig Goud / Giallo Grano / Amarillo Trigo	206	334	1971	1024	1124	5770
17	Orange / Orange / Orange / Oranje / Arancio / Naranja	208	335	1951	1137	1024	5694
18	Pumpkin / Kürbis Gelb / Citrouille / Pompoen / Giallo Zucca / Calabaza	126	322	1952	1155	1065	5630
19	Tangerine / Mandari Nenorange / Tangerine / Felorange / Mandarino / Tangerina	209	336	1965	1078	1078	5518
20	Cream Brown / Braun Weiss / Brun creme / Creme Bruin / Nocciola / Marron Crema	010	331	1866	1022	1061	5761
21	Cream Yellow / Gelblich Weiss / Jaune creme Cremegeel / Giallo Crema / Amarillo Crema	812	370	1861	1349	1135	5564
22	Khaki / Khaki Braun / Kaki / Khaki / Kaki / Caqui	348	242	1939	1255	1055	5636
23	Deep Gold / Tiefgold / Or foncé / Diepgoud / Oro Scuro / Amarillo Oro	214	354	1772	1172	1025	5770
24	Brass / Messin G Farben / Cuivre / Koper / Ottone / Bronze	328	404	1791	1192	1159	9109
25	Linen / Leinen Farbig / Drap / Linnen / Lino / Lino	307	025	1682	1149	1082	5635
26	Dark Brown / Dunkel Braun / Brun sombre / Donker Bruin / Marrone Scuro / Marron Oscuro	058	717	1859	1130	1129	5637
27	Reddish Brown / Rotbraun / Brun rougeatre / Rossing Bruin / Marrone Bruciato / Marron Rojizo	337	264	1753	1253	1021	5781
28	Clay Brown / Lehm Braun / Brun argile / Kleibruin / Marrone Argilla / Marron Tierra	339	224	1621	1021	1158	5590
29	Beige / Beige / Beige / Beige / Beige / Beige	843	012	1738	1138	1127	5598
30	Warm Gray / Warmgrau / Gris vit / Warm Grijs / Grigio Caldo / Gris Caliente	399	706	1860	1085	1218	9126
31	Russet Brown / Rotbraun / Brun roussatre / Roodbruin / Ruggine / Marron Bermejo	330	414	1726	1194	1126	5702
32	Light Brown / Hellbraun / Brun clair / Licht Bruin / Marrone Chiaro / Marron Claro	323	255	1729	1056	1128	5789
33	Seacrest / Blassgrün / Vert pale / Blauw Groen / Cresta Di Mare / Verde Celadon	542	505	1647	1219	1077	5578
34	Mint Green / Pfeffer Minzgrün / Vert menthe / Munt Groen / Verde Menta / Verde Menta	502	461	1702	1302	1047	5511
35	Leaf Green / Blattgrün / Vert feuille / Bladgroen / Verde Prato / Verde De Hoja	509	463	1749	1050	1510	5514
36	Olive Green / Olivgrün / Vert olive / Olijf Groen / Verde Oliva / Verde Oliva	519	476	1904	1396	1174	5502
37	Dark Olive / Dunkel Olivgrün / Olive foncé / Donker Olijf / Oliva Scuro / Verde Oliva Oscuro	517	473	1769	1156	1156	9122
38	Teal Green / Blaugrün / Vert sarcelle / Taling Groen / Verde Anatra / Verde Azulado	534	483	1879	1298	1503	5751
39	Emerald Green / Emerald Grün / Vert emeraude / Smaragd Groen / Verde Smeraldo / Verde Esmeralda	507	485	1750	1250	1079	5508
40	Deep Green / Dunkel Grün / Vert foncé / Diepgroen / Verde Intenso / Verde Intenso	808	467	1703	1370	1208	5615



ABC  
K2  
WV



	Color Name	Embroidery	Country	Madeira Polyneon	Madeira Rayon	Sulky Rayon	R.A. Polyester
41	Fresh Green / Frisch Grün / Vert frais / Licht Groen / Verde Mela / Verde Fresco	027	442	1706	1102	1209	9153
42	Lime Green / Limonen Grün / Vert tilleul / Limoen Groen / Verde Tiglio / Verde Lima	513	444	1848	1049	1177	5622
43	Moss Green / Moosgrün / Vert mousse / Mosgroen / Verde Muschio / Verde Musgo	515	446	1770	1369	1176	9091
44	Blue / Blau / Bleu / Blauw / Azzurro / Azul	405	586	1829	1177	1076	5684
45	Ultra Marine / Ultra Marin / Outremer / Ultra Marijn / Blu Oltremare / Azul De Ultramar	406	575	1842	1076	1042	5736
46	Light Blue / Hellblau / Bleu clair / Licht Blauw / Celeste / Azul Claro	017	150	1932	1132	1074	5683
47	Sky Blue / Himmel Blau / Bleu ciel / Hemels Blauw / Azzurro Cielo / Celeste	019	512	1828	1029	1196	5506
48	Electric Blue / Elek-Trisch-Blau / Bleu électrique / Staal Blauw / Blu Elettrico / Azul Electrico	420	564	1797	1297	1250	5829
49	Peacock Blue / Pfauen Blau / Bleu paon / Pauwen Blauw / Blu Pavone / Azul Pavo Real	415	057	1652	1252	1206	5810
50	Prussian Blue / Berliner Blau / Bleu de Prusse / Pruisisch Blauw / Blu Di Prussia / Azul De Prusia	007	588	1767	1166	1535	5737
51	Comflower Blue / Kornblu Menblau / Bleu centauree / Koren Bloemen Blauw / Blu Fior-Daliso / Azul Centaura	070	015	1830	1335	1028	5601
52	Light Lilac / Helllila / Lilas clair / Licht Lila / Lilla Chiaro / Lila Suave	810	133	1911	1031	1121	9016
53	Lilac / Lila / Lilas / Lila / Lilla / Lila	612	623	1831	1080	1080	9009
54	Violet / Violett / Violet / Violet / Violetto / Violeta	613	624	1631	1033	1194	5588
55	Purple / Purpur / Pourpre / Paars / Viola / Purpura	614	635	1880	1122	1122	5554
56	Lavender / Lavendel / Lavande / Lavendel / Lavanda / Lavanda	804	604	1630	1261	1193	5586
57	Wisteria Violet / Wistaria Violett / Violet glycine / Blauwe Regen Paars / Glicine / Violeta Vistaria	607	003	1943	1311	1032	5587
58	Pewter / Zinngrau / Etain / Tinkleurig / Peltro / Peltre	704	745	1840	1041	1041	9114
59	Dark Gray / Dunkel Grau / Gris sombre / Donker Grijs / Grigio Scuro / Gris Oscuro	707	747	1841	1241	1220	5565
60	Silver / Silber / Argent / Zilver / Argento / Plata	005	020	1812	1087	1011	5640
61	Gray / Grau / Gris / Grijs / Grigio / Gris	817	734	1640	1118	1219	5782
62		----->X					
63		-----					
64		~~~~~ TTTTTTTTTTTTTTTTTT					
65	NOT DEFINED / NICHT DEFINIERT / NON DÉFINI / NIET GEDEFINEERD / NON DEFINITO / SIN DEFINIR						

- Note:** The conversion chart is based on Embroidery thread. The color shades may vary with the different brands listed on the chart. If unsure of a particular color(s), please sew test. Robison Anton (R.A.), Isacord, Madeira, Sulky and Güetermann are respectively registered trademarks. Actual colors may vary slightly from the chart.
- Hinweis:** Die Umrechnungstabelle basiert auf dem Stickgarn. Die Farbschattierungen können je nach unterschiedlichen in der Tabelle aufgeführten Marken abweichen. Wenn Sie sich bezüglich bestimmter Farben nicht sicher sind, nähren Sie bitte zur Probe. Robison Anton (R.A.), Isacord, Madeira, Sulky und Güetermann sind eingetragene Warenzeichen. Die tatsächlichen Farben können leicht von der Tabelle abweichen.
- Remarque:** Le tableau de conversion est basé sur un fil de broderie. Les nuances de couleur peuvent varier en fonction des marques énumérées dans le tableau. En cas de doute sur un coloris, faites un essai de couture. "Robison Anton (R.A.)", "Isacord", "Madeira", "Sulky" et "Güetermann" sont des marques déposées respectives. Les couleurs réelles risquent d'être légèrement différentes de celles du tableau.
- Opmerking:** Het omzettingsschema is gebaseerd op het gebruik van borduurzijde. De kleurtinten kunnen ietwat verschillen voor de diverse merken in het schema. Als u niet zeker bent van de juiste kleur(en), borduurt u dan een stukje op proef. De namen Robison Anton (R.A.), Isacord, Madeira, Sulky en Güetermann zijn allemaal gedeponeerde handelsmerken. De feitelijke kleurtinten kunnen iets afwijken van het getoonde schema.
- Nota:** la tabella di conversione è in funzione del filo da ricamo. Le tonalità cromatiche possono variare secondo le differenti marche elencate nella tabella. In caso di dubbio su un particolare colore o su più colori si raccomanda di eseguire una prova di cucito. Robison Anton (R.A.), Isacord, Madeira, Sulky e Güetermann sono marchi di fabbrica registrati. I colori effettivi possono variare lievemente rispetto a quelli della tabella.
- Nota:** La tabla de conversión está basada en hilo de bordar. Los tonos de color podrán variar con las diferentes marcas listadas en la tabla. Si tiene dudas sobre un color(es) particular, haga un cosido de prueba. "Robison Anton (R.A.)", "Isacord", "Madeira", "Sulky" y "Güetermann" son marcas registradas respectivamente. Los colores verdaderos podrán variar ligeramente con respecto a los de la tabla.

English  
German  
French  
Dutch  
Italian  
Spanish

885-V95/V97  
XE7930-001  
Printed in China