

DISNEY DESIGN GUIDE
GUIDE DE MODÈLES DISNEY
GUÍA DE DISEÑO DISNEY

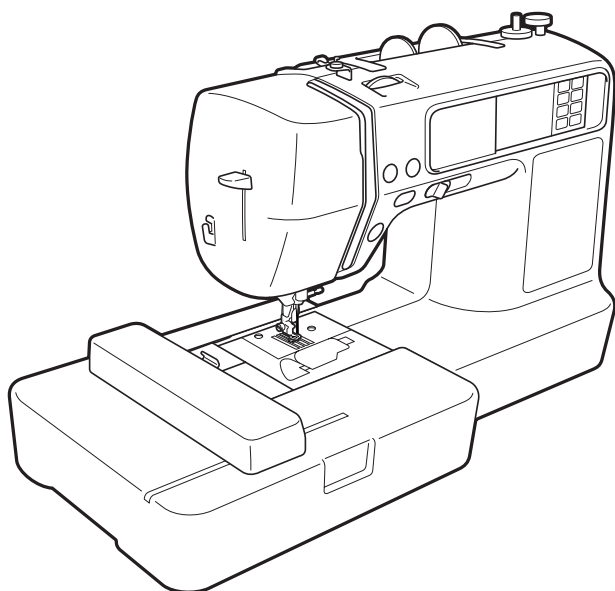

brother®
at your side

©Disney

WARNING
AVERTISSEMENT
ADVERTENCIA

The embroidery patterns which are pre-programmed into this sewing machine are for personal, private use only. Any commercial or business use is strictly forbidden by copyright laws.

Les motifs de broderie préprogrammés dans cette machine à coudre sont destinés à l'utilisation personnelle seulement. Toute utilisation commerciale est rigoureusement interdite par les lois des droits d'auteur.

Los bordados preprogramados en la máquina de coser son sólo para uso personal y privado. El uso comercial está estrictamente prohibido por las leyes de protección de los derechos de copia.

Refer to the operation manual for detailed instruction.

Also, there are differences in the keys and screens depending on the display language. In this guide, English screens are used for basic explanations.

Pour les instructions détaillées, voir le manuel d'instructions.

Par ailleurs, il y a des différences dans les touches et les écrans en fonction de la langue d'affichage. Dans ce guide, les explications de base utilisent les écrans anglais.

Consulte el manual de instrucciones para ver más detalles.

Además, dependiendo del idioma visualizado algunos botones y pantallas podrán ser diferentes. En esta guía, para las explicaciones básicas se emplean pantallas en inglés.

Selecting Disney characters
Sélection des personnages Disney
Seleccionando caracteres Disney

- 1 Turn off the power and set the machine up for embroidery following the instructions in the machine manual.

Mettre la machine hors tension et effectuer les préparatifs pour la broderie en suivant les instructions du manuel de la machine.

Apague la alimentación y prepare la máquina para bordar siguiendo las instrucciones indicadas en el manual de la máquina.

- 2 Turn on the power switch and touch the screen.
Mettre l'interrupteur d'alimentation sous tension et effleurer l'écran.
Conecte el interruptor principal y toque la pantalla.

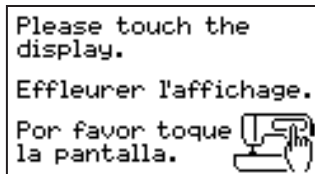

3 Press **OK**. The carriage of the embroidery unit will move to the initial setting position.

Appuyer sur **OK**. Le chariot de l'unité de broderie se place à la position du réglage initial.

Toque **OK**. El carro de la unidad de bordado se moverá a la posición de ajuste inicial.

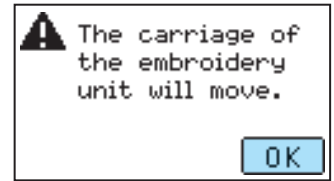

4 The pattern selections will be displayed as shown right.

Press "🐻".

Les sélections de motifs sont affichées comme il est indiqué ci-contre à droite. Appuyer sur "🐻".

Los patrones seleccionados de patrones serán exhibidas tal como se indican a la derecha.

Toque "🐻".

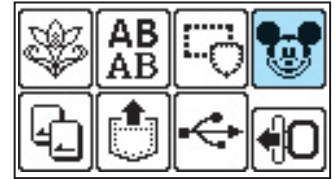

5 Press the key that corresponds to the desired pattern group.

- ① Disney (standard) patterns
- ② Disney·Pixar patterns

Appuyez sur la touche correspondant au groupe de motifs souhaités.

- ① Motifs Disney (standard)
- ② Motifs Disney·Pixar

Presione la tecla correspondiente al grupo de patrones deseado.

- ① Patrones Disney (estándar)
- ② Patrones Disney·Pixar

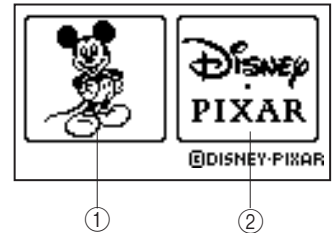

6 Press the key that corresponds to the desired pattern. The sewing screen will then be displayed.

Appuyer sur la touche correspondant au motif voulu. L'écran de couture apparaît alors.

Toque la tecla que corresponde con el patrón deseado. Se exhibirá la pantalla de costura.

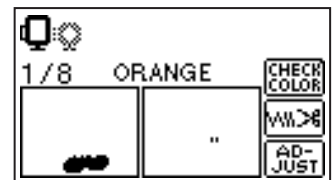
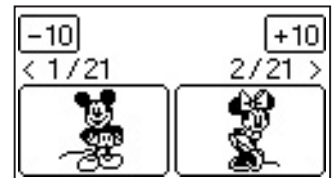

Color change table

Tableau des changements de couleur

Tabla de cambio de color

- The figures in shaded areas indicate the estimated time needed for the pattern to be embroidered. They do not include the time required to change threads.
- Les chiffres contenus dans les zones grisées indiquent le temps estimé nécessaire pour le motif à broder. Ils ne prennent pas en compte le temps nécessaire pour changer les fils.
- Los números sombreados indican el tiempo estimado necesario para bordar el patrón. No incluye el tiempo necesario para cambiar los hilos.

A pattern ★ is an embroidery pattern which uses appliqué: No. 19.
 Un motif ★ est un motif de broderie qui utilise l'appliqué : N° 19.
 Un patrón ★ es un patrón bordado que utiliza dibujo aplicado N° 19.

Refer to the operation manual for details on how to embroider the pattern.
 Se reporter au manuel d'instructions pour les détails concernant la façon de broder le motif.
 Consulte el manual de instrucciones por detalles sobre como bordar el patrón.

Note: The Disney character patterns built into this unit cannot be resized or flipped.
 Remarque : Les motifs des personnages de Disney intégrés dans l'unité ne peuvent être ni redimensionnés ni orientés différemment.
 Nota: Los diseños de personajes de Disney incorporados en esta unidad no podrán ser cambiados de tamaño ni darles la vuelta.

- The products in this guide are creations of Brother Industries (K.K.) using the Disney Copyright under contract with The Walt Disney Company.
- Les produits décrits dans ce guide ont été créés par Brother Industries (K.K.) en utilisant les droits d'auteur de Disney sous contrat de The Walt Disney Company.
- Los productos en este guía son creaciones de Brother Industries (K.K.) que usan los derechos de autor de Disney mediante contrato con The Walt Disney Company.

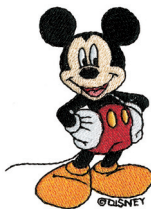

No.1

15 min
1 (208)
2 (205)
3 (800)
4 (001)
5 (079)
6 (307)
7 (900)
8 (001)

Order to embroider
Séquence pour broder
Orden para el bordador

Embroidery size
Taille de la broderie
Tecla de tamaño

Embroidery thread color number
Numéro de couleur du fil de broderie
Número de color del hilo de bordado

Time required for embroidering
Durée requise pour broder
Tiempo requerido para el bordado

Embroidery thread color
Couleur du fil de broderie
Color del hilo de bordado

No.2

15 min
1 (001)
2 (307)
3 (019)
4 (085)
5 (900)
6 (001)

Embroidery size
Taille de la broderie
Tecla de tamaño



No.3

15 min
1 (017)
2 (001)
3 (079)
4 (214)
5 (205)
6 (208)
7 (405)
8 (800)
9 (900)

Embroidery size
Taille de la broderie
Tecla de tamaño



No.4

12 min
1 (017)
2 (001)
3 (612)
4 (208)
5 (085)
6 (900)

Embroidery size
Taille de la broderie
Tecla de tamaño

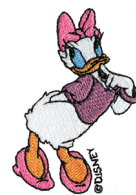



12 min	
1	(800)
2	(079)
3	(001)
4	(507)
5	(214)
6	(900)

↓7.1cm ↔7.3cm



16 min	
1	(205)
2	(339)
3	(079)
4	(086)
5	(214)
6	(001)
7	(307)
8	(030)
9	(900)

↓6.2cm ↔7.2cm



7 min	
1	(030)
2	(001)
3	(507)
4	(513)
5	(208)
6	(513)
7	(001)
8	(800)

↓2.0cm ↔6.0cm



17 min	
1	(001)
2	(800)
3	(079)
4	(307)
5	(513)
6	(209)
7	(405)
8	(058)
9	(900)

↓8.7cm ↔6.2cm



11 min	
1	(001)
2	(800)
3	(307)
4	(513)
5	(900)

↓4.7cm ↔4.2cm



9 min	
1	(000)
2	(264)
3	(747)
4	(000)

↓5.2cm ↔6.0cm

COUNTRY



7 min	
1	(800)
2	(900)

↓1.3cm ↔6.3cm



38 min	
1	(001)
2	(513)
3	(307)
4	(800)
5	(339)
6	(208)
7	(507)
8	(019)
9	(843)
10	(900)
11	(001)

↓8.3cm ↔9.2cm



13 min	
1	(000)
2	(370)
3	(264)
4	(747)
5	(000)

↓5.3cm ↔6.9cm

COUNTRY



7 min	
1	(800)
2	(900)

↓1.3cm ↔6.4cm



29 min	
1	(214)
2	(209)
3	(614)
4	(001)
5	(307)
6	(030)
7	(513)
8	(900)
9	(205)
10	(507)
11	(513)
12	(001)

↓7.0cm ↔7.4cm



29 min	
1	(001)
2	(307)
3	(800)
4	(208)
5	(339)
6	(214)
7	(513)
8	(323)
9	(507)
10	(900)
11	(001)

↓9.6cm ↔8.8cm



8 min	
1	(264)
2	(000)
3	(354)
4	(747)
5	(000)

↓5.6cm ↔3.0cm

COUNTRY

No.18



8 min	
1	(354)
2	(264)
3	(150)
4	(000)
5	(505)
6	(747)
7	(000)

↓ 6.3cm ↔ 2.9cm

COUNTRY

★ No.19



7 min	
1	(000)
2	(000)
3	(000)
4	(000)
5	(745)
6	(747)
7	(000)

↓ 4.5cm ↔ 5.6cm

COUNTRY

No.20



10 min	
1	(017)
2	(208)
3	(001)
4	(502)
5	(307)
6	(030)
7	(810)
8	(058)
9	(323)

↓ 5.1cm ↔ 3.8cm

No.21



11 min	
1	(208)
2	(001)
3	(030)
4	(810)
5	(010)
6	(307)
7	(205)
8	(058)
9	(323)

↓ 5.5cm ↔ 3.7cm



No.1



27 min	
1	(001)
2	(704)
3	(800)
4	(900)
5	(707)
6	(704)
7	(030)
8	(800)
9	(005)
10	(214)
11	(208)
12	(800)
13	(900)
14	(019)
15	(420)

↓ 4.6cm ↔ 8.3cm

No.2



37 min	
1	(001)
2	(843)
3	(339)
4	(704)
5	(513)
6	(058)
7	(707)
8	(900)
9	(058)
10	(704)
11	(005)

↓ 6.8cm ↔ 9.0cm

No.3



17 min	
1	(001)
2	(900)
3	(005)
4	(704)
5	(534)
6	(017)
7	(019)
8	(420)
9	(900)
10	(214)
11	(323)
12	(900)

↓ 4.5cm ↔ 6.9cm

No.4



27 min	
1	(001)
2	(843)
3	(704)
4	(900)
5	(405)
6	(420)
7	(001)
8	(209)
9	(405)
10	(339)
11	(900)

↓ 5.7cm ↔ 9.2cm

No.5 17 min



1	(030)
2	(307)
3	(208)
4	(001)
5	(205)
6	(704)
7	(900)
8	(704)

↓8.2cm ↔6.6cm

No.10 29 min



1	(001)
2	(005)
3	(339)
4	(612)
5	(017)
6	(534)
7	(900)

↓9.6cm ↔8.3cm

No.14 24 min



1	(214)
2	(900)
3	(707)
4	(005)
5	(704)
6	(800)
7	(707)
8	(058)
9	(513)
10	(707)
11	(208)
12	(001)
13	(900)
14	(707)
15	(019)

↓7.7cm ↔6.9cm

No.6 10 min



1	(030)
2	(307)
3	(001)
4	(086)
5	(339)
6	(208)
7	(205)
8	(900)

↓7.7cm ↔4.6cm

No.11 12 min



1	(001)
2	(005)
3	(323)
4	(513)
5	(019)
6	(507)
7	(900)

↓5.6cm ↔4.7cm

No.7 9 min



1	(001)
2	(208)
3	(124)
4	(214)
5	(900)
6	(030)
7	(017)

↓3.9cm ↔3.8cm

No.12 28 min



1	(001)
2	(005)
3	(307)
4	(086)
5	(339)
6	(058)
7	(612)
8	(017)
9	(534)
10	(900)

↓8.2cm ↔9.6cm

No.8 13 min



1	(001)
2	(208)
3	(214)
4	(900)
5	(001)
6	(208)
7	(214)
8	(900)

↓5.8cm ↔5.1cm

No.13 14 min

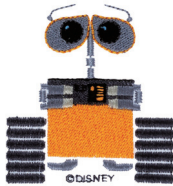

1	(704)
2	(208)
3	(707)
4	(900)
5	(704)
6	(005)
7	(707)
8	(019)

↓6.8cm ↔6.3cm

No.9 20 min



1	(001)
2	(017)
3	(420)
4	(205)
5	(007)
6	(900)
7	(001)
8	(208)
9	(214)
10	(900)

↓6.4cm ↔7.0cm

