

Quick Reference Guide

Stichwortregister

Guide de référence rapide

Beknopte bedieningsgids

Guida di riferimento rapido

Guía de referencia rápida

Hurtigguide

Snabbstarts guide

Hurtig referenceguide

Pikaopas

Краткий справочник

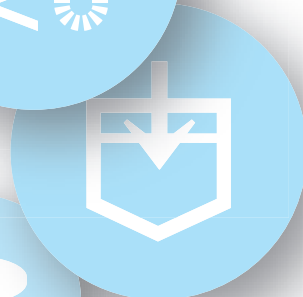
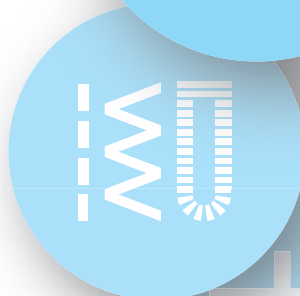
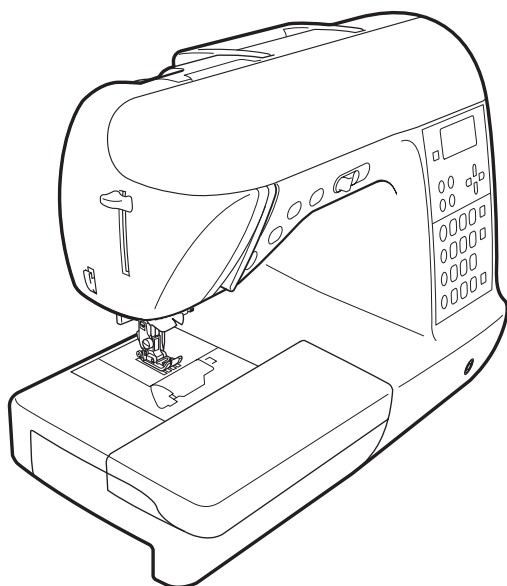

Refer to the operation manual for detailed instruction.

Ausführliche Hinweise finden Sie in der Bedienungsanleitung.

Reportez-vous au manuel d'instructions pour des informations détaillées.

In de bedieningshandleiding vindt u uitvoerige aanwijzingen.

Consultare il manuale d'istruzione per istruzioni dettagliate.

Consulte el manual de instrucciones para obtener información detallada.

Du finner nærmere informasjon i brukerhåndboken.

Detaljerade instruktioner finns i bruksanvisningen.

Se brugsanvisningen vedrørende en detaljeret vejledning.

Käyttöohjeessa on yksityiskohtaisia lisätietoja.

Более подробная информация представлена в Руководстве по эксплуатации.

Contents

Inhalt
Inhoud
Contenido
Innehåll
Innehåll
Sisällysluettelo

Table des matières
Sommario
Innhold
Indhold
Содержание

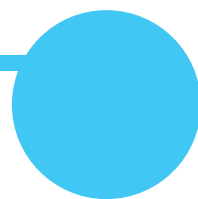

Bobbin winding and setting

2

Aufspulen und Einsetzen der Unterfadenspule
Spoel winden en installeren
Colocación y devanado de la bobina
Spola upp undertråd och sätta in spolen
Puolaus ja asetus

Bobinage et réglage de la canette
Avvolgimento e impostazione della spolina
Innstillinger for og vikling av spoler
Vinding og isætning af spolen
Намотка и установка шпульки



Upper threading

4

Einfädeln des Oberfadens
Bovendraad inrijgen
Enhebrado del hilo superior
Trå övertråden
Ylälangan pujotus

Enfilage supérieur
Infilatura superiore
Træ overtråden
Trædning af overtråd
Заправка верхней нити



Selecting stitch patterns

6

Auswahl von Stichmustern
Steekpatronen selecteren
Selección de patrones de costura
Välja mönster
Ompeleen valinta

Sélection des motifs de point
Selezione di disegni/punti
Velge sømmønster
Valg af stingmønstre
Выбор рисунков строчек



Combining and saving patterns

10

Kombinieren und Speichern von Mustern
Patronen combineren en opslaan
Combinación y almacenamiento de patrones
Kombinera och spara mönster
Kuvioiden yhdistely ja tallennus

Combinaison et enregistrement de motifs
Combinazione e salvataggio di disegni
Kombinere og lagre mønstre
Kombinering og lagring af mønstre
Сочетание различных рисунков строчек и сохранение в памяти



Saved patterns' memo

11

Notizen für gespeicherte Muster
Opgeslagen patronen
Memoria de patrones guardados
Kom ihåg för sparade mönster
Tallennetut kuviot

Mémo des motifs enregistrés
Promemoria disegni salvati
Merknad om lagrede mønstre
Liste over gemte mønstre
Памятка для сохраненных рисунков



Summary of stitch patterns

12

Übersicht der Stichmuster
Overzicht van steekpatronen
Resumen de patrones de costura
Översikt över mönster
Ompeleiden yhteenveto

Résumé des motifs de point
Riepilogo disegni/punti
Oppsummering av sømmønstre
Oversigt over stingmønstre
Рисунки строчек

Bobbin winding and setting



Aufspulen und Einsetzen der Unterfadenspule
Spoel winden en installeren
 Colocación y devanado de la bobina
 Spola upp undertråd och sätta in spolen
Puolaus ja asetus

Bobinage et réglage de la canette
 Avvolgimento e impostazione della spolina
 Innstillinger for og vikling av spoler
Vinding og isætning af spolen
 Намотка и установка шпульки

Use only the included bobbin or bobbins of the same type.

Verwenden Sie nur die im Lieferumfang enthaltene Spule oder Spulen vom selben Typ.

N'utilisez que la canette fournie ou une canette du même type.

Gebruik uitsluitend de bijgeleverde spoel of spoelen van hetzelfde type.

Utilizzare esclusivamente la spolina fornita o spoline dello stesso tipo.

Utilice sólo la bobina suministrada o bobinas del mismo tipo.

Bruk kun spolen som leveres med maskinen, eller spoler av samme type som denne.

Använd bara spolen som medföljer eller spolar av samma typ.

Brug kun den medfølgende spole eller spoler af samme type.

Käytä vain tämän ompelukoneen mukana toimitettuja puolia tai samantyyppisiä puolia.

Используйте только входящую в комплект шпульку или шпульки одного типа.

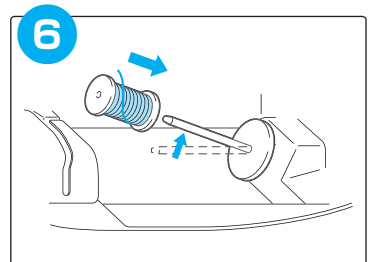
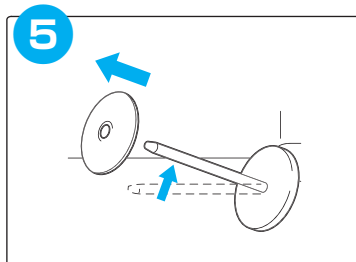
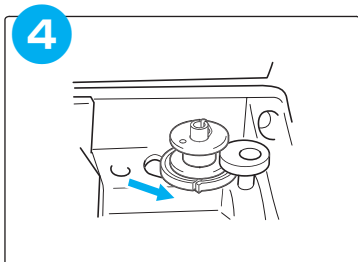
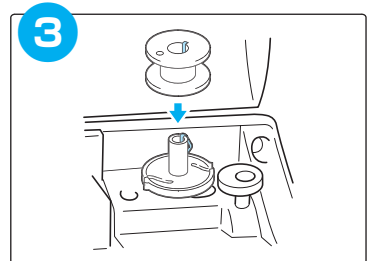
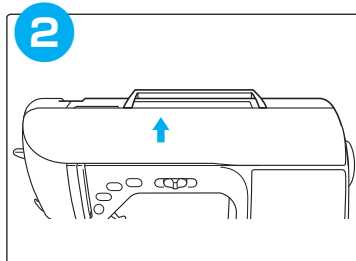
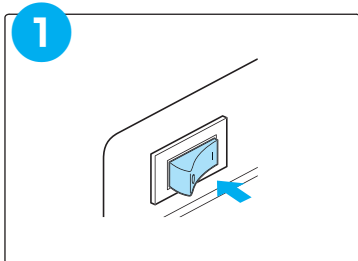
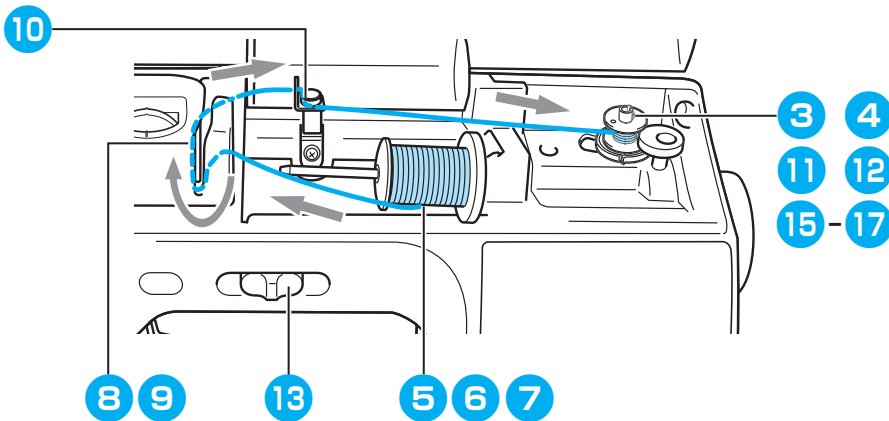
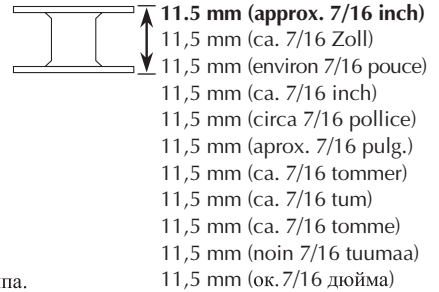

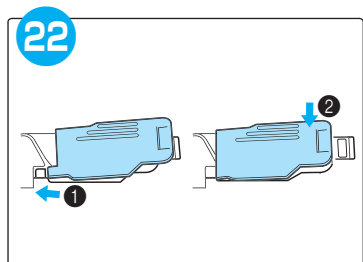
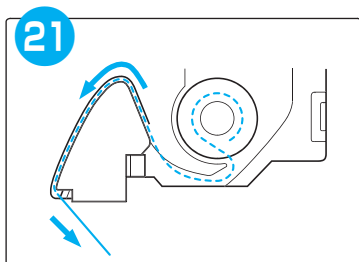
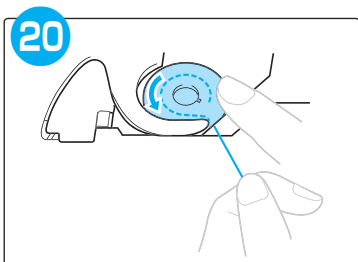
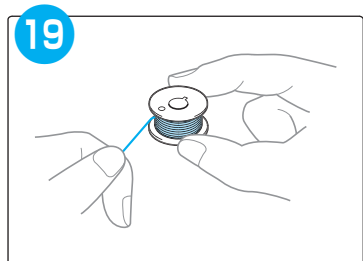
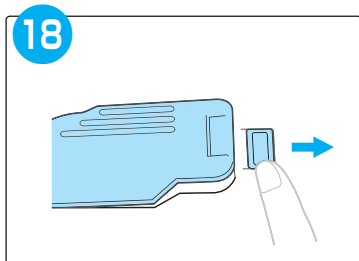
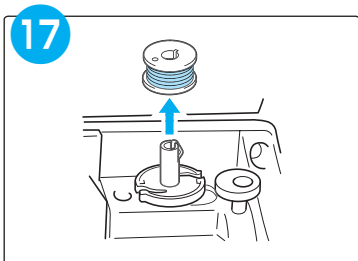
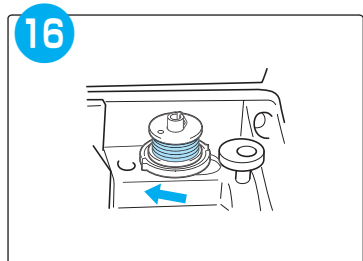
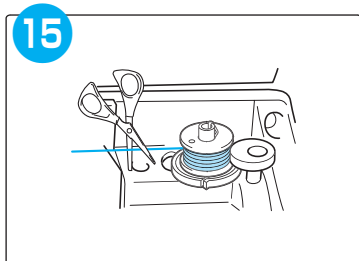
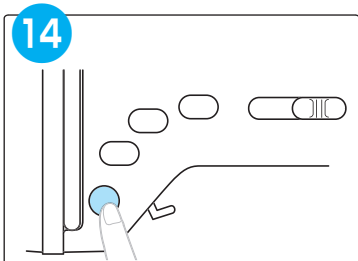
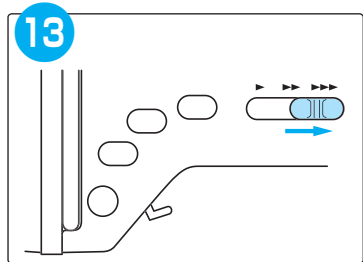
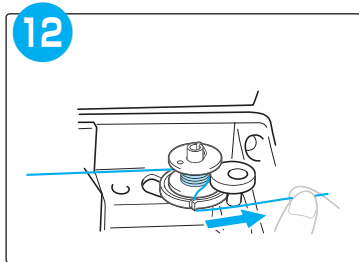
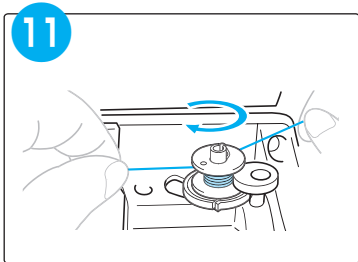
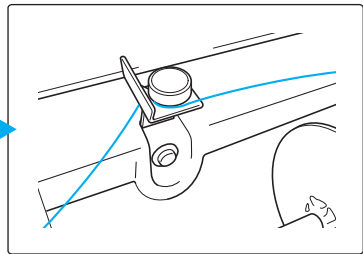
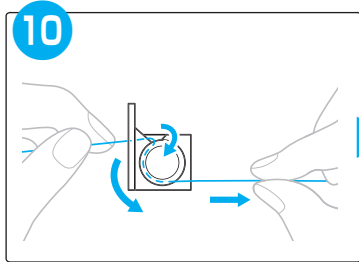
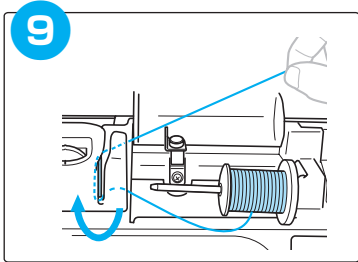
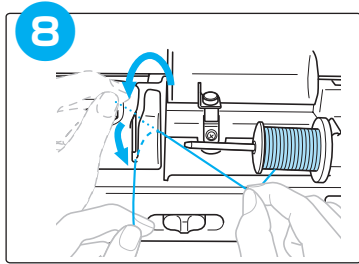
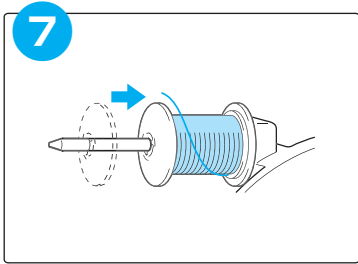
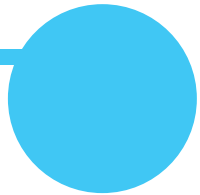



Upper threading

Einfädeln des Oberfadens
 Bovendraad inrijgen
 Enhebrado del hilo superior
 Trä övertråden
 Ylälangan pujotus

Enfilage supérieur
 Infilatura superiore
 Træ overtråden
 Trædning af overtråd
 Заправка верхней нити

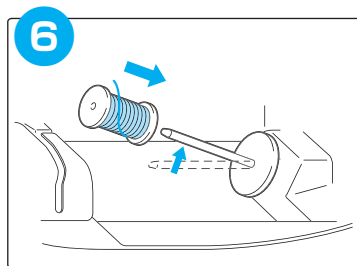
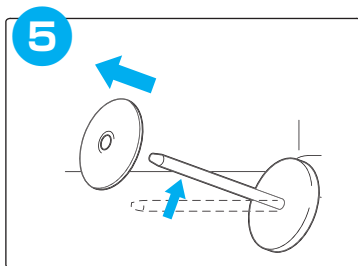
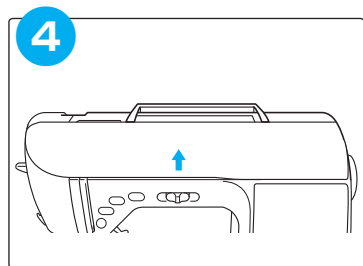
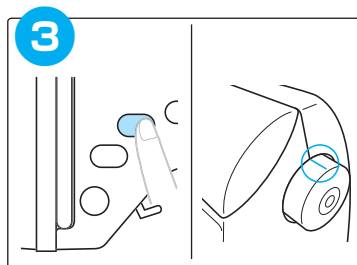
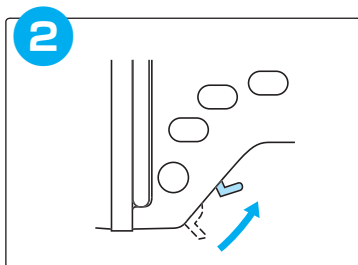
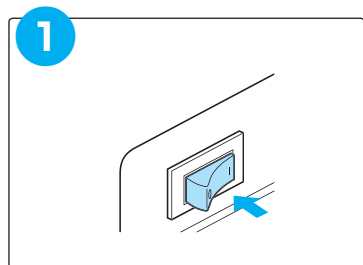
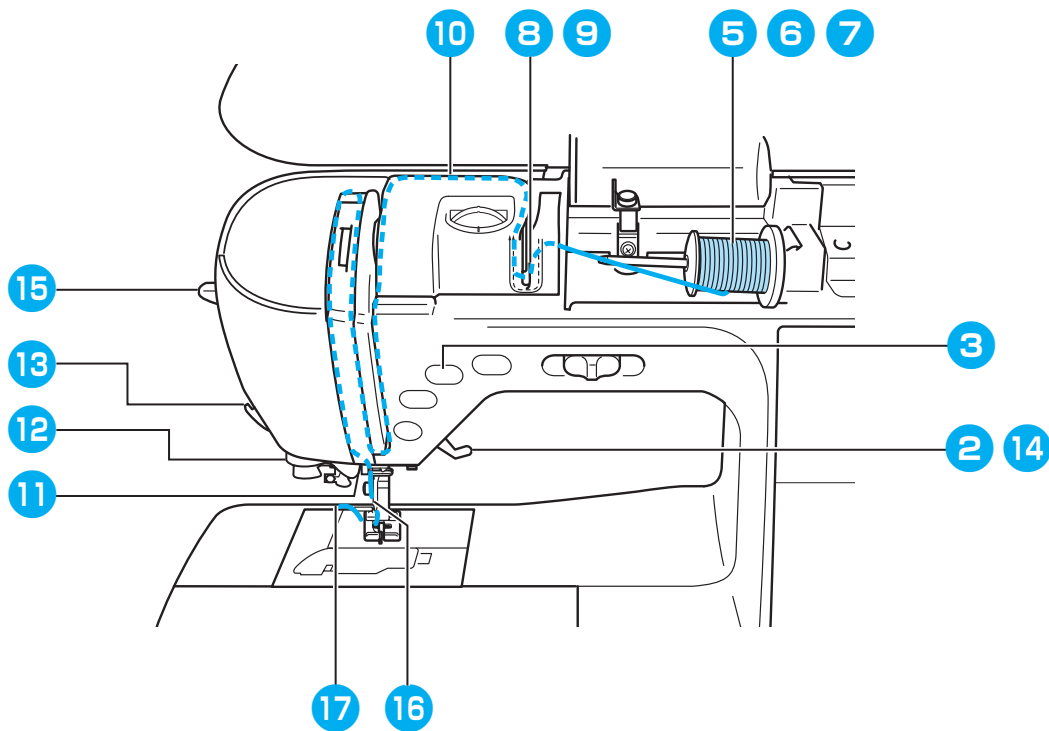

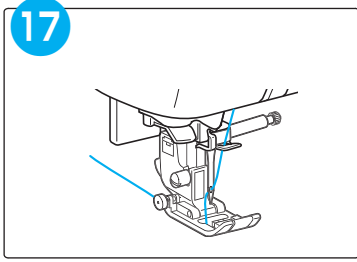
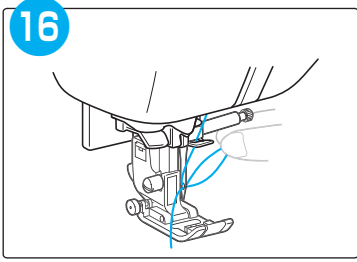
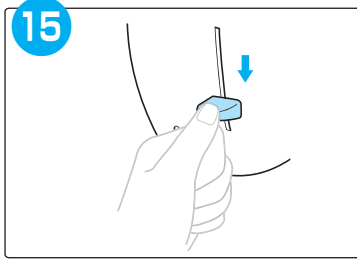
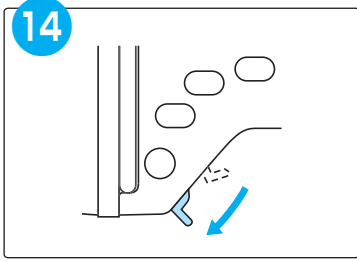
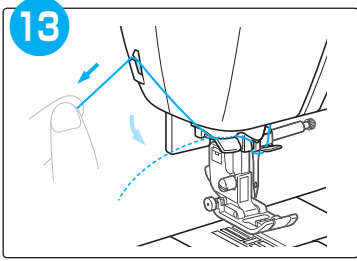
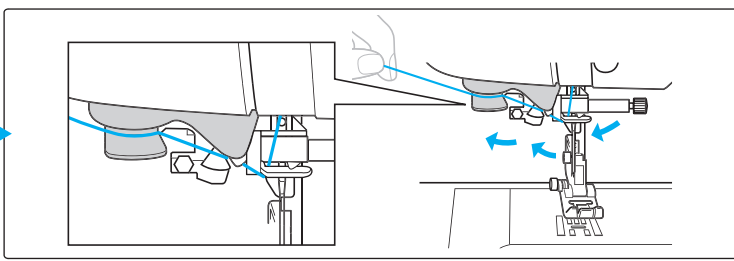
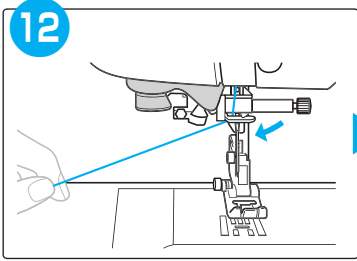
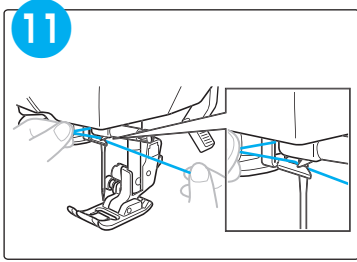
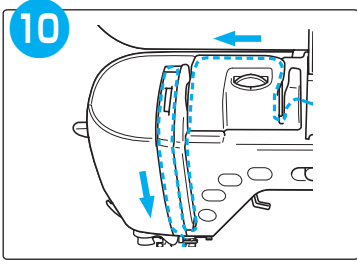
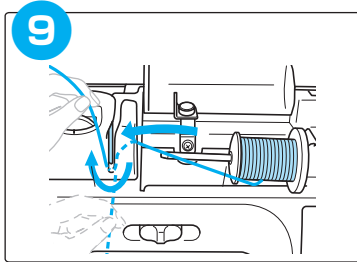
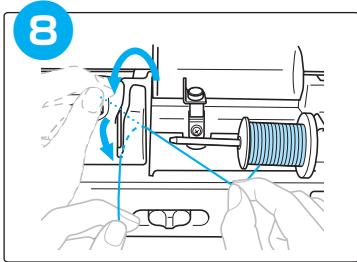
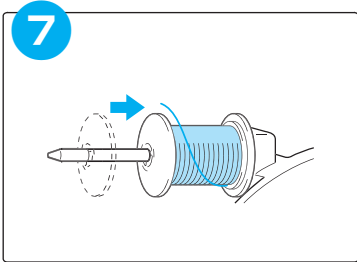
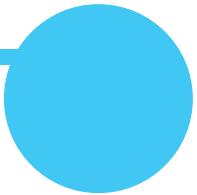

Selecting stitch patterns

Auswahl von Stichmustern
 Steekpatronen selecteren
 Selección de patrones de costura
 Välja mönster
 Ompeleen valinta

Sélection des motifs de point
 Selezione di disegni/punti
 Velge sømmønster
 Valg af stingmønstre
 Выбор рисунков строчек

Preset utility stitch/ saved pattern

Voreingestellter Nutzstich/
 Gespeichertes Muster

Préréglage de point de
 couture courant/motif
 enregistré

Vooraf ingestelde naaisteek/
 opgeslagen patroon

Punto utile preimpostato/
 disegno salvato

Costura con aplicaciones
 preajustada/patrones
 guardados

Forhåndsinnstilt nyttesøm/
 lagret mønster

Förinställd nyttosöm/
 sparat mönster

Forindstillede brugssting/
 gemt mønster

Esiasetettu hyötyommel/
 tallennettu kuvio

Стандартная обычная строчка /
 сохраненный рисунок

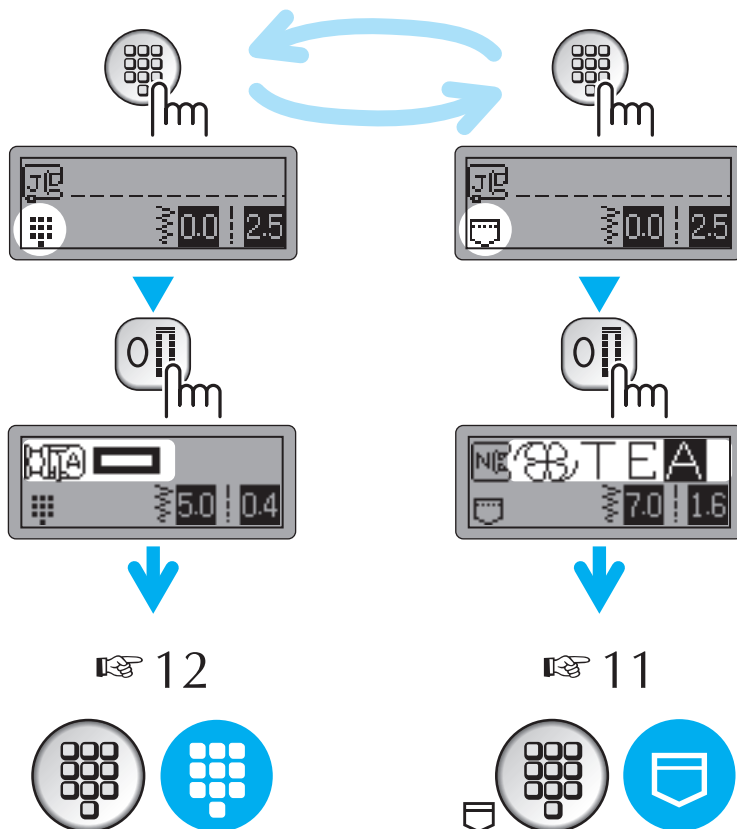

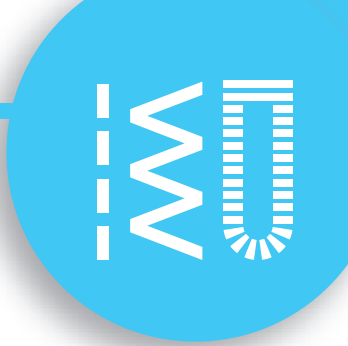

Utility stitches

- Nutzstiche
- Points de couture courants
- Naaisteken
- Punti utili
- Puntadas con aplicaciones
- Nyttesøm
- Nyttosömmar
- Brugssting
- Hyötyompeleet
- Обычные строчки

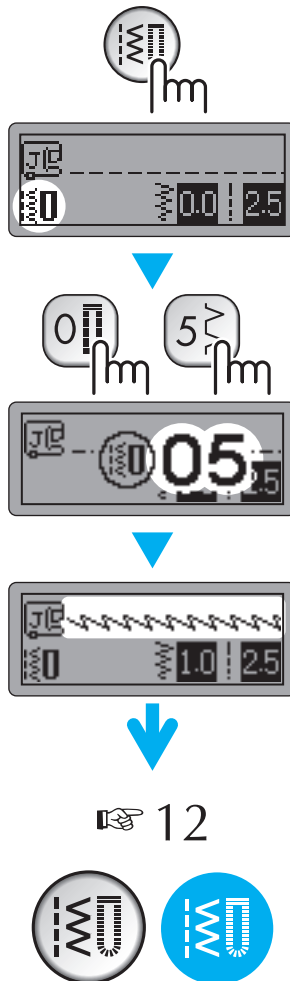



Decorative stitches

- Dekorstiche
- Points décoratifs
- Decoratieve steken
- Punti decorativi
- Puntadas decorativas
- Dekorsøm
- Dekorativa sömmar
- Dekorationssting
- Koristeompeleet
- Декоративные строчки

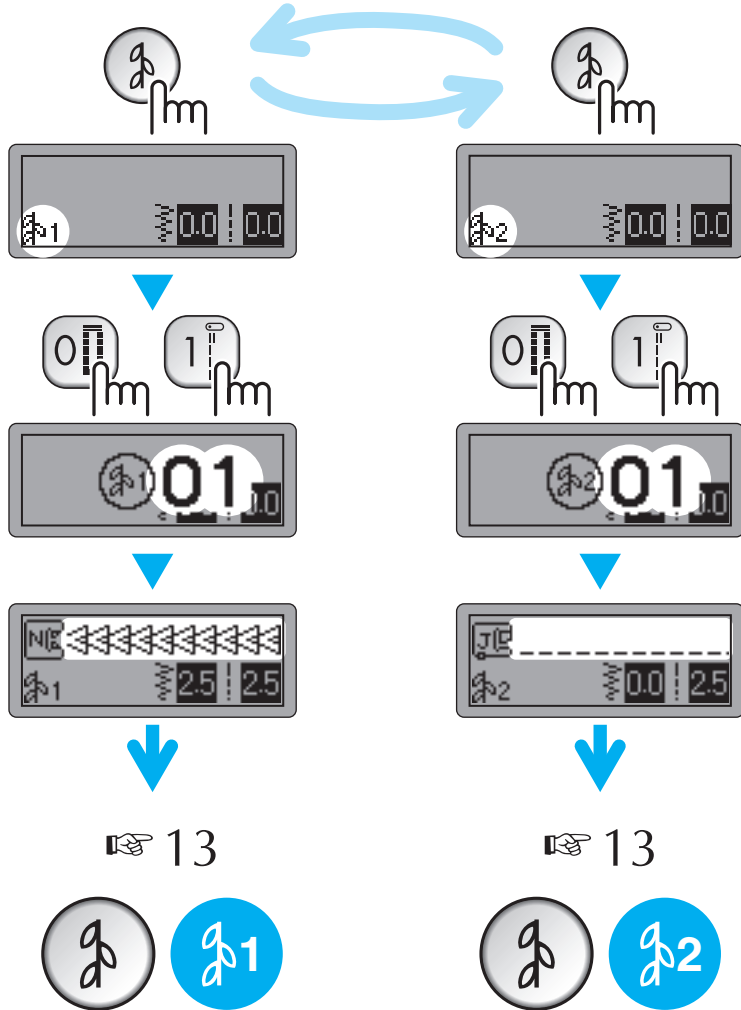

A

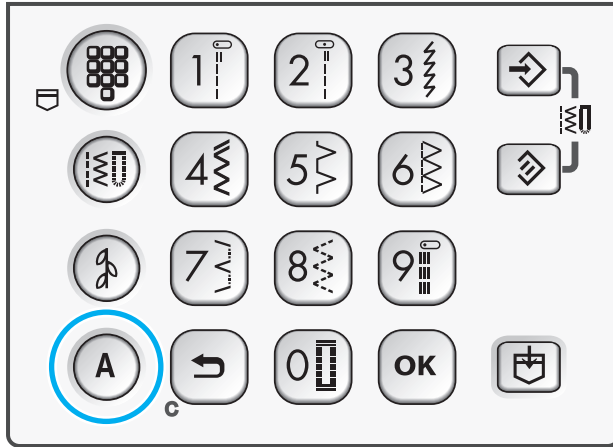

- Character stitches**
 Buchstabenstiche
 Points caractères
 Lettersteken
 Punti caratteri
 Puntadas de caracteres
 Bokstavsøm
 Teckensnittssömmar
 Tegning
 Kirjontaompeleet
 Вышивание текста

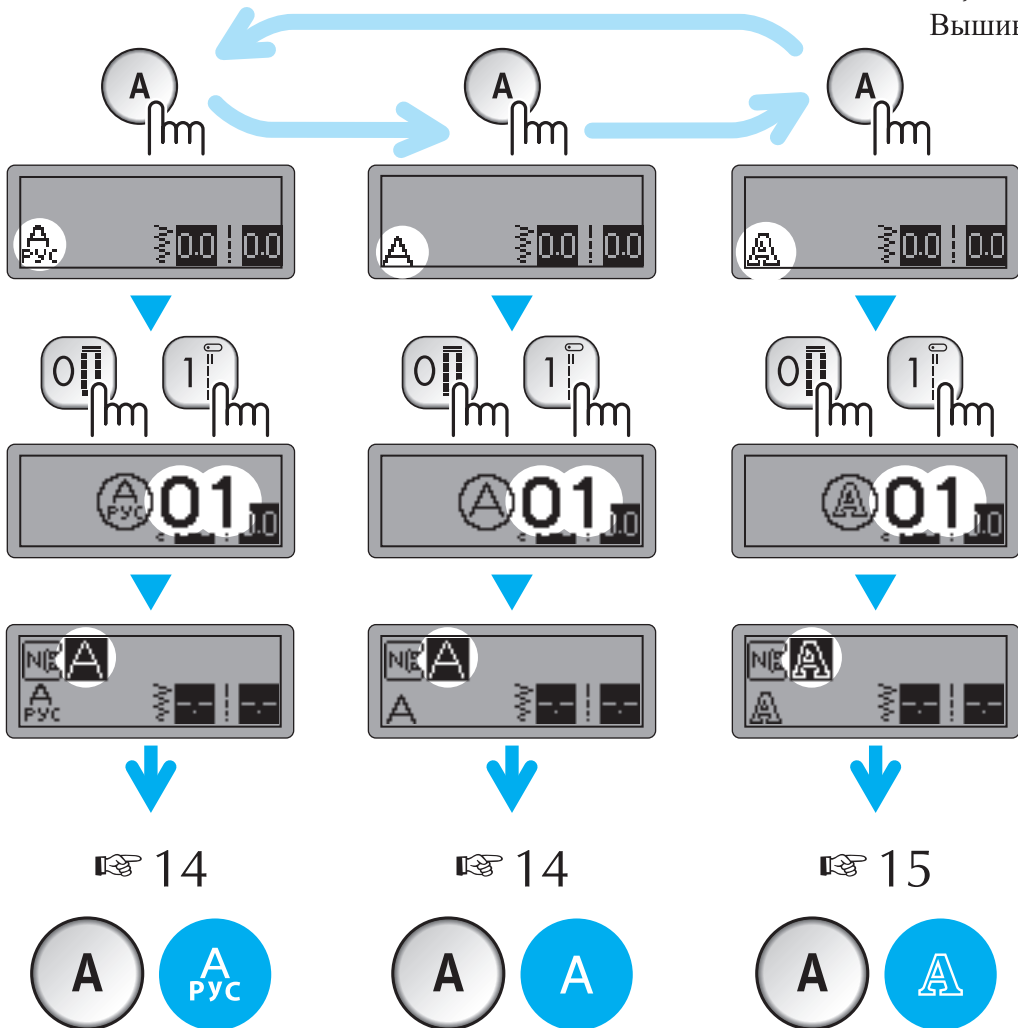



Combining and saving patterns

Kombinieren und Speichern von Mustern
 Patronen combineren en opslaan
 Combinación y almacenamiento de patrones
 Kombinera och spara mönster
 Kuvioiden yhdistely ja tallennus

Combinaison et enregistrement de motifs
 Combinazione e salvataggio di disegni
 Kombinere og lagre mønstre
 Kombinering og lagring af mønstre
 Сочетание различных рисунков строчек и сохранение в памяти

Example: Beispiel: Exemple: Voorbeeld: Esempio: Ejemplo:
 Eksempel: Exempel: Eksempel: Esimerkki: Пример:



Combining patterns Kombinieren von Mustern/ Combinaison de motifs/ Patronen combineren/ Combinazione di disegni/
 Combinación de patrones/ Kombinere mønstre/ Kombinera mönster/ Kombinering af mønstre/ Kuvioiden yhdistely/ Сочетание различных строчек

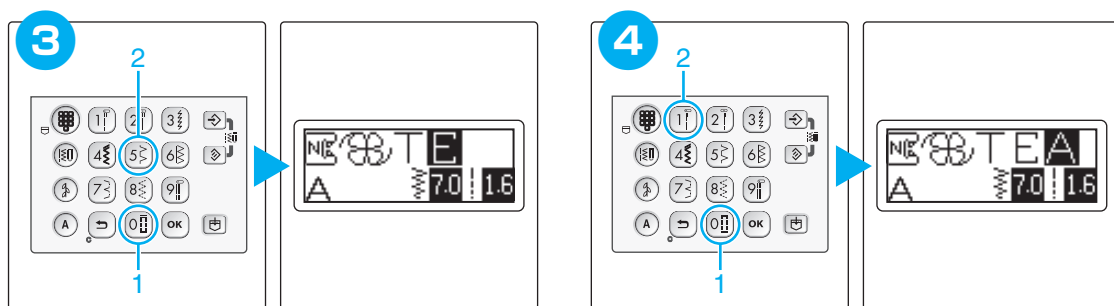
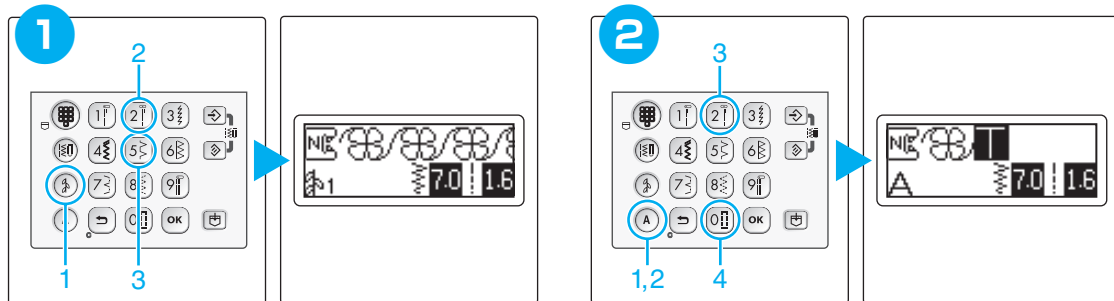

Saving patterns Speichern von Mustern/ Enregistrement des motifs/ Patronen opslaan/ Salvataggio di disegni/
 Almacenamiento de patrones/ Lagre et mønstre/ Spara mönster/ Sådan gemmes mønstre/ Kuvioiden tallennus/ Сохранение рисунков в памяти

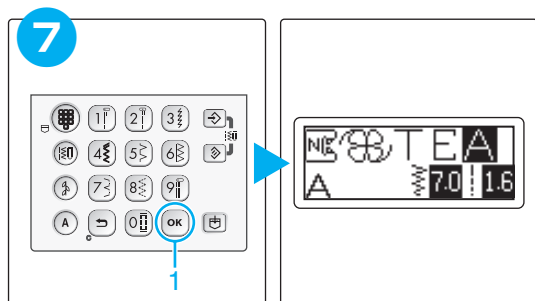
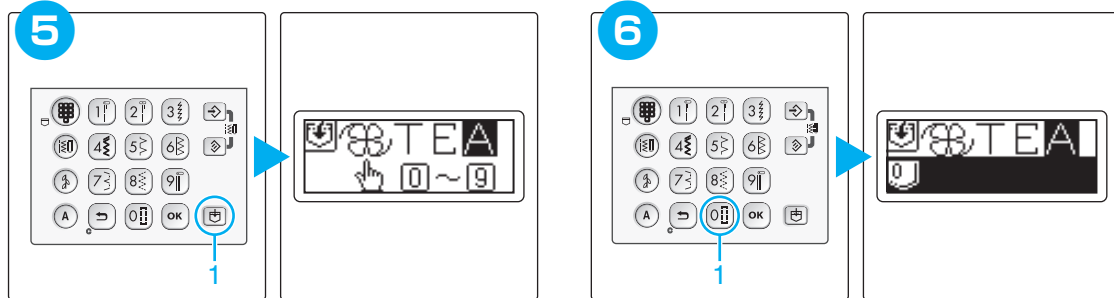

Saved patterns' memo

Notizen für gespeicherte Muster
Oppgslagen patronen
Memoria de patrones guardados
Kom ihåg för sparade mönster
Tallennetut kuviot

Mémo des motifs enregistrés
Promemoria disegni salvati
Merknad om lagrede mønstre
Liste over gemte mønstre
Памятка для сохраненных рисунков



Saved patterns Gespeicherte Muster/ Motifs enregistrés/ Oppgslagen patronen/ Disegni salvati
Patrones guardados/ Lagrede mønstre/ Sparade mönster/ Gemte mønstre/ Tallennetut kuviot/ Сохраненные рисунки

1	
2	
3	
4	
5	
6	
7	
8	
9	
0	

Summary of stitch patterns

Übersicht der Stichmuster

Overzicht van steekpatronen

Resumen de patrones de costura

Översikt över mönster

Ompeleiden yhteenveto

Résumé des motifs de point

Riepilogo disegni/punti

Oppsummering av sømmønstre

Oversigt over stingmønstre

Рисунки строчек



Preset utility stitch

Voreingestellter Nutzstich/ Préréglage de point de couture courant/

Vooraf ingestelde naaisteek/ Punto utile preimpostato/ Costura con aplicaciones preajustada/ Forhåndsinnstilt nyttesøm/

Förinställd nyttesöm/ Forindstilte brugssting/ Esiasetettu hyötöommel/ Стандартная обычная строчка

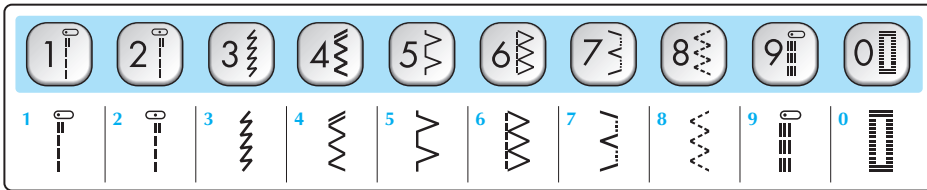

Utility stitches

Nutzstiche/ Points de couture courants/ Naaisteken/ Punti utili/

Puntadas con aplicaciones/ Nyttesøm/ Nyttesømmer/ Brugssting/ Hyötöompeleet/ Обычные строчки

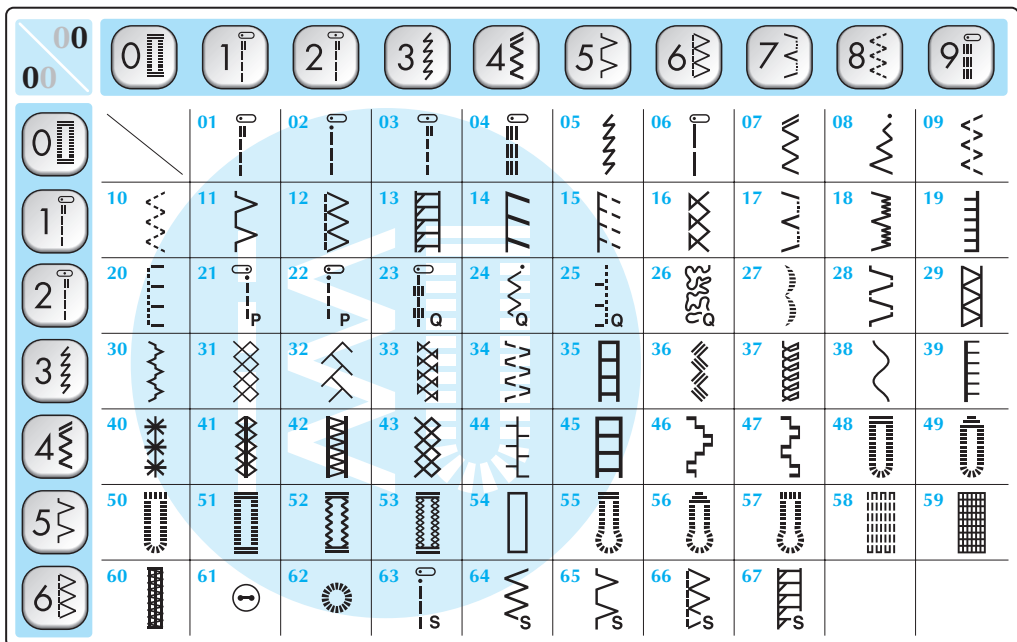



Decorative stitches Dekorstiche/ Points décoratifs/ Decoratieve steken/ Punti decorativi/
Puntadas decorativas/ Dekorsøm/ Dekorativa sömmar/ Dekorationssting/ Koristeompeleet/ Декоративные строчки

00	0	1	2	3	4	5	6	7	8	9
00	0	01	02	03	04	05	06	07	08	09
1	10	11	12	13	14	15	16	17	18	19
2	20	21	22	23	24	25	26	27	28	29
3	30	31	32	33	34	35	36	37	38	39
4	40	41	42	43	44	45	46	47	48	49
5	50	51	52	53	54	55	56	57	58	59
6	60	61	62							
9										99



Decorative stitches Dekorstiche/ Points décoratifs/ Decoratieve steken/ Punti decorativi/
Puntadas decorativas/ Dekorsøm/ Dekorativa sömmar/ Dekorationssting/ Koristeompeleet/ Декоративные строчки

00	0	1	2	3	4	5	6	7	8	9
00	0	01	02	03	04	05	06	07	08	09
1	10	11	12	13	14	15	16	17	18	19
2	20	21	22	23	24	25	26	27	28	29
3	30	31	32	33	34	35	36	37	38	39

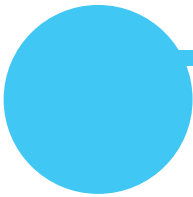

A

A
PVC

Character stitches (Cyrillic letter) Buchstabenstiche (Kyrillischer Zeichensatz)/
Points caractères (Police cyrillique)/ Lettersteken (Cyrillische letter)/ Punti carattere (Lettera cirillica)/
Puntadas de caracteres (Letra cirilica)/ Bokstavsøm (Kyrilliske bokstav)/ Teckensnittssömmar (Kyrilliska bokstav)/
Tegnsting (Kyrilliske bogstav)/ Kirjontaompeleet (Kyrillinen aakonen)/ Вышивание текста (Кириллица)

00	01	02	03	04	05	06	07	08	09
00	01	02	03	04	05	06	07	08	09
01	01	02	03	04	05	06	07	08	09
10	11	12	13	14	15	16	17	18	19
20	21	22	23	24	25	26	27	28	29
30	31	32	33	34	35	36	37	38	39
40	41	42	43	44	45	46	47	48	49
50	51	52							

A

A

Character stitches (Gothic font) Buchstabenstiche (Schriftart Gotisch)/
Points caractères (police Gothic)/ Lettersteken (lettertype Gothic)/ Punti carattere (carattere gotico)/
Puntadas de caracteres (escritura gótica)/ Bokstavsøm (skrifttypen Gothic)/ Teckensnittssömmar (Gothic)/
Tegnsting (skrifttypen Gothic)/ Kirjontaompeleet (goottilainen kirjasin)/ Вышивание текста (печатный шрифт)

00	01	02	03	04	05	06	07	08	09
00	01	02	03	04	05	06	07	08	09
01	01	02	03	04	05	06	07	08	09
10	11	12	13	14	15	16	17	18	19
20	21	22	23	24	25	26	27	28	29
30	31	32	33	34	35	36	37	38	39
40	41	42	43	44	45	46	47	48	49
50	51	52	53	54	55				

A



Character stitches (Outline style)

Buchstabenstiche (Umriss)/
Points caractères (style Contours)/ Lettersteken (opmaak Contour)/ Puntti caratteri (stile contorno)/
Puntadas de caracteres (escritura con borde)/ Bokstavsøm (Outline-stil)/ Teckensnittssømmer (Konturstil)/
Tegnsting (Outline-stil)/ Kirjontaompeleet (ääriiviivatyli)/ Вышивание текста (контурный шрифт)

00										
	01	02	03	04	05	06	07	08	09	
	A	B	C	D	E	F	G	H	I	
	10	11	12	13	14	15	16	17	18	19
	J	K	L	M	N	O	P	Q	R	S
	20	21	22	23	24	25	26	27	28	29
	T	U	V	W	X	Y	Z	&	?	!
	30	31	32	33	34	35	36	37	38	39
	_	0	1	2	3	4	5	6	7	8
	40	41	42	43	44	45	46	47	48	49
	9	'	,	.	()	-	Ä	À	Æ
	50	51	52	53	54	55				
	Ñ	Ö	Ø	Ç	Ü	ß				

