

brother®

Operation Manual

- **1** GETTING READY
- **Read before use.** ● **2** SEWING BASICS
- **3** UTILITY STITCHES
- **Read when additional information is required.** ● **4** APPENDIX

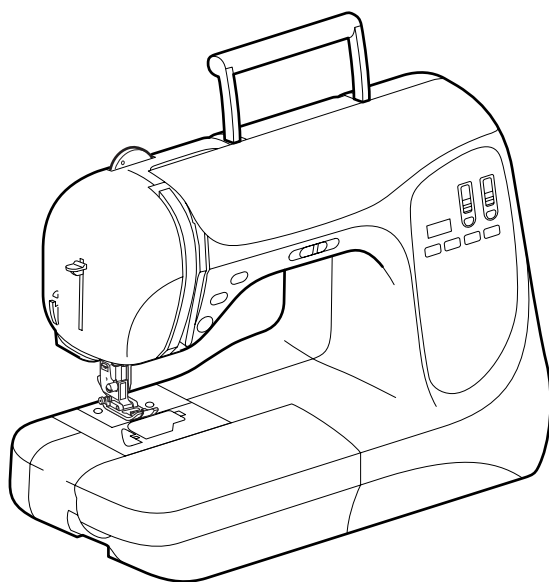

*Computerized Sewing Machine*  
**Operation Manual**

## Enclosed Accessories

After opening the box, check that the following accessories are enclosed. If any item is missing or damaged, contact your retailer.

### Accessories

The following items should also be enclosed in the box.

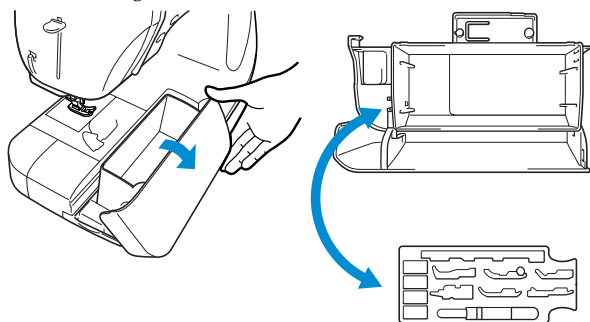

#### Note

(For U.S.A. only)

- Foot controller: Model N5V  
This foot controller can be used on this machine model NX-200/PC-210.
- The screw of the presser foot holder is available through your authorized dealer. (Part code: XA4813-051)
- The organized accessory tray is available through your authorized dealer. (Part code: XC4489-051)

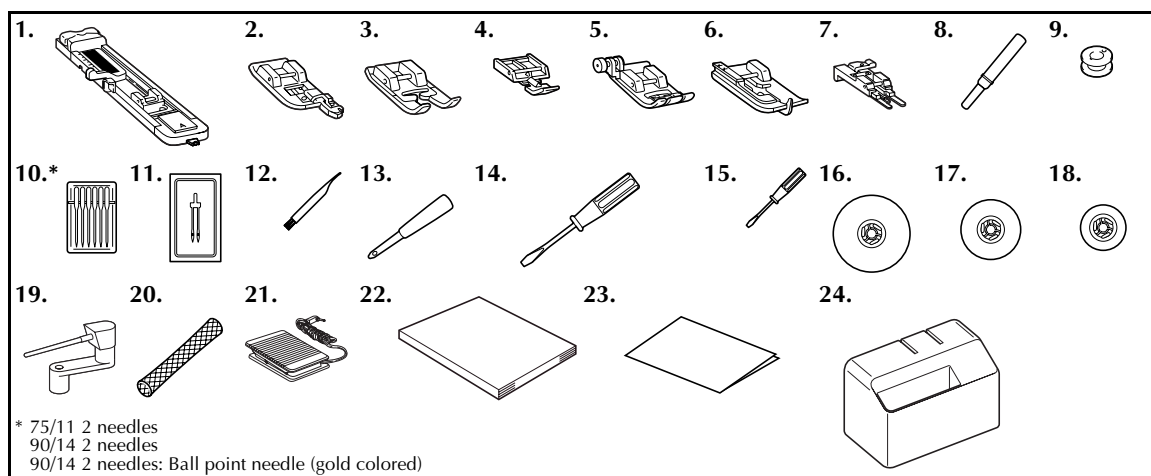

No.	Part Name	Part Code		No.	Part Name	Part Code	
		U.S.A.	Others			U.S.A.	Others
1	Buttonhole foot "A"	XC2691-051		13	Eyelet punch	135793-001	
2	Overcasting foot "G"	XC3098-051		14	Screwdriver (large)	X55467-051	
3	Monogramming foot "N"	X53840-351		15	Screwdriver (small)	X55468-051	
4	Zipper foot "I"	X59370-051		16	Spool cap (large)	130012-054	
5	Zigzag foot "J" (on machine)	XC3021-051		17	Spool cap (medium)(2)	X55260-153	
6	Blind stitch foot "R"	X56409-051		18	Spool cap (small)	130013-154	
7	Button fitting foot "M"	130489-001		19	Extra spool pin (horizontal)	XC4654-051	
8	Seam ripper	X54243-001		20	Spool net	XA5523-050	
9	Bobbin (4)	SA156	XA5539-151	21	Foot controller	XC1154-051	
10	Needle set	X58358-051		22	Operation manual	XE1140-001	
11	Twin needle	X59296-051		23	Quick reference guide	XC4546-151	
12	Cleaning brush	X59476-051		24	Hard case	XC2360-152	

# Names of Machine Parts and Their Functions

The names of the various parts of the sewing machine and their functions are described below. Before using the sewing machine, carefully read these descriptions to learn the names of the machine parts.

## Front view

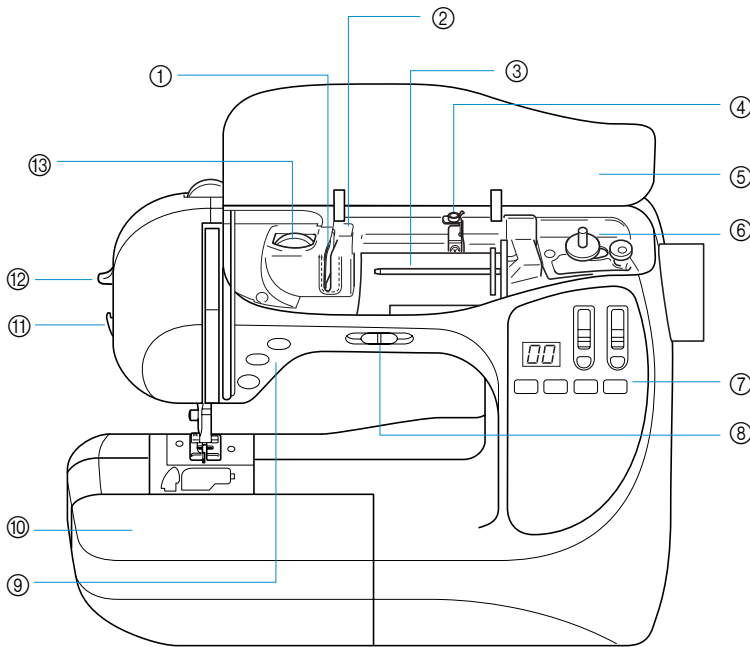

① **Thread guide plate / ② Thread guide cover**

Pass the thread around the thread guide plate when threading the upper thread.

③ **Spool pin**

Place the spool on the spool pin.

④ **Thread guide for bobbin winding**

Pass the thread around this thread guide when winding the bobbin thread.

⑤ **Upper cover**

Open the upper cover to place the spool of thread on the spool pin.

⑥ **Bobbin winder**

Use the bobbin winder when winding the bobbin.

⑦ **Operation panel**

Select a stitch from those that appear in the operation panel. (page Cover E)

⑧ **Sewing speed controller**

Use the sewing speed controller to adjust the sewing speed.

⑨ **Operation buttons**

Use the operation buttons to start the sewing machine and raise and lower the needle. (page Cover D)

⑩ **Flat bed attachment with accessory compartment**

Store presser feet and bobbins in the accessory compartment of the flat bed attachment. When sewing cylindrical pieces, remove the flat bed attachment.

⑪ **Thread cutter**

Pass the threads through the thread cutter to cut them.

⑫ **Needle threader lever**

Use the needle threader to thread the needle.

⑬ **Thread tension dial**

Use the thread tension dial to adjust the tension of the upper thread.

## Needle and presser foot section

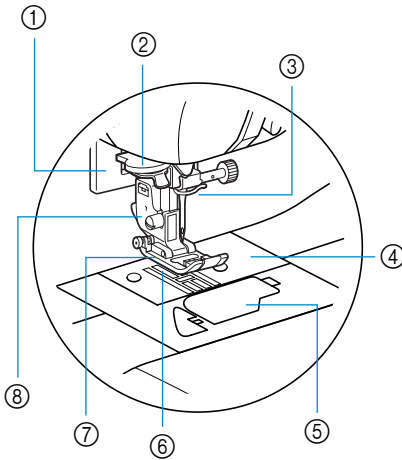

- ① **Buttonhole lever**  
Lower the buttonhole lever when sewing buttonholes and bar tacks.
- ② **Thread guide discs**  
Pass the thread through the thread guide discs when using the needle threader to thread the needle.
- ③ **Needle bar thread hook**  
Pass the upper thread through the needle bar thread hook.
- ④ **Needle plate**  
The needle plate is marked with guides for sewing straight seams.
- ⑤ **Bobbin cover/shuttle**  
Remove the bobbin cover, and then insert the bobbin into the shuttle.
- ⑥ **Feed dogs**  
The feed dogs feed the fabric in the sewing direction.
- ⑦ **Presser foot**  
The presser foot applies pressure consistently on the fabric as the sewing takes place. Attach the appropriate presser foot for the selected stitching.
- ⑧ **Presser foot holder**  
The presser foot is installed onto the presser foot holder.

## Right-side/rear view

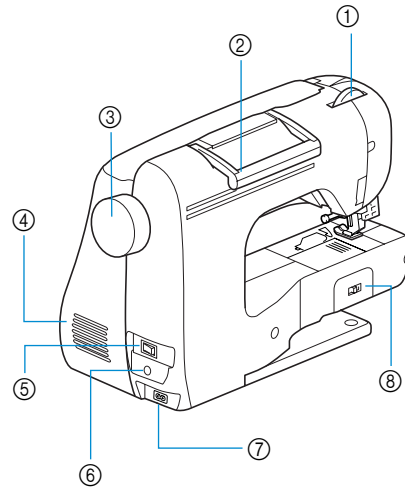

- ① **Presser foot dial**  
Use the presser foot dial to adjust the amount of pressure that the presser foot applies to the fabric.
- ② **Handle**  
Carry the sewing machine by its handle when transporting the machine.
- ③ **Balance wheel**  
Turn the balance wheel toward you to raise and lower the needle to sew one stitch.
- ④ **Air vent**  
The air vent allows the air surrounding the motor to be exchanged. Do not cover the air vent while the sewing machine is being used.
- ⑤ **Main power switch**  
Use the main power switch to turn the sewing machine on and off.
- ⑥ **Foot controller jack**  
Insert the plug on the end of the foot controller cable into the foot controller jack.
- ⑦ **Power supply jack**  
Insert the plug on the power supply cord into the power supply jack.
- ⑧ **Feed dog position switch**  
Use the feed dog position switch to lower the feed dogs.

### Memo

- Refer to Cover B, D or E pages while you are learning to use your machine.

## Operation buttons

The operation buttons help you to easily perform various basic sewing machine operations.

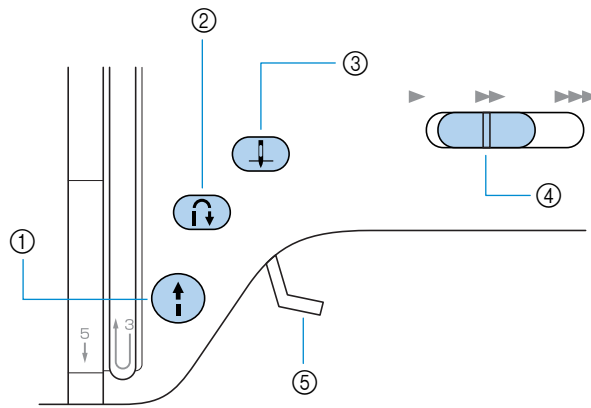

### ① Start/stop button

Press the start/stop button to start or stop sewing. The machine sews at a slow speed at the beginning of sewing while the button is depressed. When sewing is stopped, the needle is lowered in the fabric. For details, refer to “Starting to sew” (page 39).

The button lights up in green, red or orange, depending on how the sewing machine is being operated.

Green: When the machine is ready to start sewing or while it is sewing

Red: When the machine is not ready to start sewing

Orange: When the bobbin winder shaft is moved to the right for winding the bobbin thread onto the bobbin

### ② Reverse/reinforcement stitch button

Press the reverse/reinforcement stitch button to sew reverse stitches or reinforcement stitches. Reverse stitches are sewn by keeping the button pressed down to sew in the opposite direction. Reinforcement stitches are sewn by sewing 3 to 5 stitches on top of each other. For details, refer to “Securing the stitching” (page 41).

### ③ Needle position button

Press the needle position button to raise or lower the needle. Pressing the button twice sews one stitch.

### ④ Sewing speed controller

Slide the sewing speed controller to adjust the sewing speed.

### ⑤ Presser foot lever

Raise and lower the presser foot lever to raise and lower the presser foot.

## Operation panel

The operation panel, located on the front at the right of the sewing machine, consists of various buttons and sliders for specifying how the stitch will be sewn.

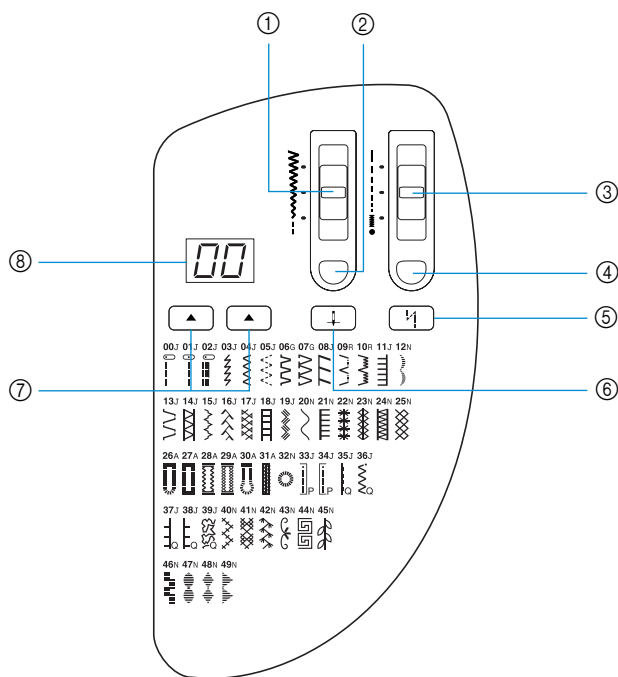

- ① **Stitch width adjustment slider** / ② **Stitch width adjustment button**  
These are used to adjust the width of the stitch or the needle position. After pressing the stitch width adjustment button, use the stitch width adjustment slider to adjust the stitch width.
- ③ **Stitch length adjustment slider** / ④ **Stitch length adjustment button**  
These are used to adjust the length of the stitch. After pressing the stitch length adjustment button, use the stitch length adjustment slider to adjust the stitch length.
- ⑤ **Automatic reverse/reinforcement stitch key**  
Press the automatic reverse/reinforcement stitch key to automatically sew reverse or reinforcement stitches at the beginning and end of stitching.
- ⑥ **Needle stop position key**  
This is used to change the position of the needle when the sewing machine is stopped. If the key is lit, the sewing machine will stop with the needle lowered. If the key is not lit, the sewing machine will stop with the needle raised.
- ⑦ **Stitch selection key** / ⑧ **Stitch indicator**  
Press the stitch selection key, and then select the number for the stitch that you wish to use. 50 stitches are available. For details, refer to "Selecting Stitching" (page 54).
- ⑨ **Stitches**  
There are 50 stitches. Select stitch 00-49.  
A letter (A, G, J, N or R) indicating the presser foot that should be used appears to the right of the stitch number.

## Optional Accessories

The following are available as optional accessories.

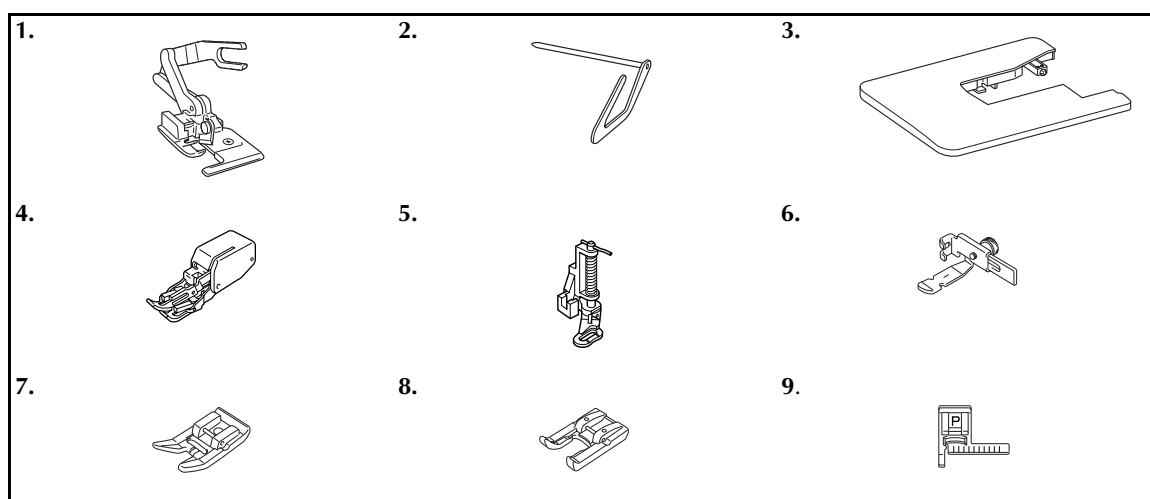

1. **Side cutter**  
Part code: SA177, XC3879-002
2. **Quilting guide**  
Part code: SA132, XC2215-002
3. **Wide table**  
Part code: SA537, XC4541-051
4. **Walking foot**  
Part code: SA140, XC2214-002
5. **Quilting foot**  
Part code: SA129, XC1948-002
6. **Adjustable zipper/piping foot**  
Part code: SA161, XC1970-002
7. **Non stick foot**  
Part code: SA114, XC1949-002
8. **Open toe foot**  
Part code: SA147, XC1964-002
9. **Stitch guide foot "P"**  
Part code: SA160, XA8839-002



### Memo

- To obtain optional accessories or parts, contact your sales representative or the nearest authorized service center.

## Introduction

Thank you for purchasing this sewing machine.

Before using this sewing machine, carefully read the “Important Safety Instructions” (page 6), and then study this manual for the correct operation of the various functions.

In addition, after you have finished reading this manual, store it where it can quickly be accessed for future reference.

## Sewing Machine Features

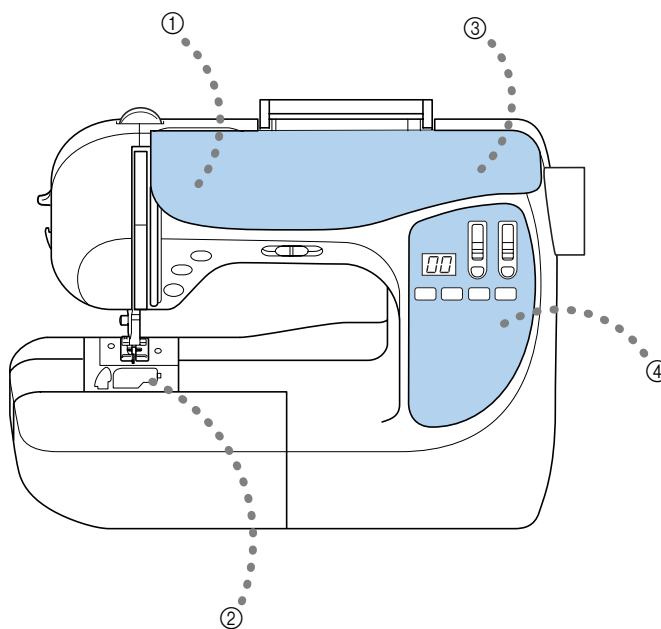

① **Easy upper threading**

Since the spool can be installed at the front of the sewing machine, the upper thread can easily be threaded. In addition, the needle can be threaded with a simple operation. (page 18)

② **One-touch lower threading**

You can start sewing without pulling up the bobbin thread. (page 16)

③ **Simple bobbin-winding**

The bobbin can quickly and easily be wound with thread. (page 12)

④ **Built-in stitches**

You can select from the built-in stitches available, including utility stitches and decorative stitches. (page 54)



# Contents

<b>Enclosed Accessories</b> .....	<b>Cover A</b>
Accessories .....	Cover A
<b>Names of Machine Parts and Their Functions</b> .....	<b>Cover B</b>
Front view .....	Cover B
Needle and presser foot section .....	Cover C
Right-side/rear view .....	Cover C
Operation buttons .....	Cover D
Operation panel .....	Cover E
<b>Optional Accessories</b> .....	<b>1</b>
<b>Introduction</b> .....	<b>2</b>
<b>Sewing Machine Features</b> .....	<b>2</b>
<b>Contents</b> .....	<b>3</b>
<b>Important Safety Instructions</b> .....	<b>6</b>

## GETTING READY ..... 9

<b>Turning the Machine On/Off</b> .....	<b>10</b>
Power supply precautions .....	10
Turning on the machine .....	11
Turning off the machine .....	11
<b>Winding/Installing the Bobbin</b> .....	<b>12</b>
Bobbin precautions .....	12
Winding the bobbin .....	12
Installing the bobbin .....	16
<b>Upper Threading</b> .....	<b>18</b>
Threading the upper thread .....	18
Threading the needle .....	21
Using the twin needle .....	22
Using thread that winds off quickly .....	24
Pulling up the bobbin thread .....	25
<b>Replacing the Needle</b> .....	<b>26</b>
Needle precautions .....	26
Needle types and their uses .....	26
Checking the needle .....	27
Replacing the needle .....	28
<b>Replacing the Presser Foot</b> .....	<b>29</b>
Presser foot precautions .....	29
Replacing the presser foot .....	29
Adjusting the pressure of the presser foot .....	30
Removing the presser foot holder .....	31
Using the optional walking foot .....	31
<b>Sewing Cylindrical or Large Pieces</b> .....	<b>33</b>
Stitching cylindrical pieces .....	33
Sewing large pieces of fabric .....	33

## SEWING BASICS ..... 35

<b>Sewing</b> .....	<b>36</b>
General sewing procedure .....	37
Positioning the fabric .....	38
Starting to sew .....	39
Securing the stitching .....	41
Cutting the thread .....	43
<b>Adjusting the Thread Tension</b> .....	<b>44</b>
Changing the tension of the upper thread .....	44

<b>Adjusting the Stitch Width and Length</b> .....	<b>45</b>
Adjusting the stitch width .....	45
Adjusting the stitch length .....	46
<b>Useful Functions</b> .....	<b>47</b>
Changing the needle stop position .....	47
Automatically sewing reverse/reinforcement stitches .....	47
<b>Useful Sewing Tips</b> .....	<b>49</b>
Trial sewing .....	49
Changing the sewing direction .....	49
Sewing curves .....	49
Sewing thick fabrics .....	50
Sewing thin fabrics .....	51
Sewing stretch fabrics .....	51
Sewing an even seam allowance .....	51
<b>UTILITY STITCHES</b> .....	<b>53</b>
<b>Selecting Stitching</b> .....	<b>54</b>
Selecting stitching .....	54
<b>Overcasting Stitches</b> .....	<b>56</b>
Sewing overcasting stitches using overcasting foot “G” .....	56
Sewing overcasting stitches using zigzag foot “J” .....	57
Sewing overcasting stitches using the optional side cutter .....	58
<b>Basic Stitching</b> .....	<b>60</b>
Basic stitching .....	60
<b>Blind Hem Stitching</b> .....	<b>61</b>
<b>Buttonhole Stitching</b> .....	<b>63</b>
Buttonhole sewing .....	64
Button sewing .....	67
<b>Zipper Insertion</b> .....	<b>70</b>
Inserting a centered zipper .....	70
Inserting a side zipper .....	71
<b>Sewing Stretch Fabrics and Elastic Tape</b> .....	<b>74</b>
Stretch stitching .....	74
Elastic attaching .....	74
<b>Appliqué, Patchwork and Quilt Stitching</b> .....	<b>76</b>
Appliqué stitching .....	77
Patchwork (crazy quilt) stitching .....	78
Piecing .....	78
Quilting .....	79
Free-motion quilting .....	80
<b>Reinforcement Stitching</b> .....	<b>82</b>
Triple stretch stitching .....	82
Bar tack stitching .....	82
<b>Eyelet Stitching</b> .....	<b>84</b>
<b>Decorative Stitching</b> .....	<b>85</b>
Fagoting .....	86
Scallop stitching .....	87
Smocking .....	87
Joining .....	88
Heirloom stitching .....	89

<b>APPENDIX</b> .....	<b>91</b>
<b>Stitch Settings</b> .....	<b>92</b>
Utility stitches .....	92
<b>Maintenance</b> .....	<b>96</b>
Cleaning the machine surface .....	96
Cleaning the shuttle .....	96
<b>Troubleshooting</b> .....	<b>98</b>
Error messages .....	101
Operation beep .....	102
Removing the upper cover .....	102
<b>Index</b> .....	<b>103</b>

## Important Safety Instructions

When using this machine, basic safety precautions should always be taken, including the following:

Read all instructions before using.

**DANGER** - To reduce the risk of electric shock:

1. The machine should never be left unattended while plugged in. Always unplug the machine from the electrical outlet immediately after using and before cleaning.

**WARNING** - To reduce the risk of burns, fire, electric shock, or injury to persons:

1. Do not allow this machine to be used as a toy. Close attention is necessary when the machine is used by or near children.
2. Use this machine only for its intended use as described in this manual. Use only accessories recommended by the manufacturer as contained in this manual.
3. Never operate this machine if it has a damaged cord or plug, if it is not working properly, if it has been dropped or damaged, or dropped into water. Return the machine to the nearest authorized dealer or service center for examination, repair, electrical or mechanical adjustment.
4. Never operate the machine with any air openings blocked. Keep ventilation openings of the machine and foot control free from the accumulation of lint, dust, and loose cloth.
5. Never drop or insert any object into any opening.
6. Do not use outdoors.
7. Do not operate where aerosol (spray) products are being used or where oxygen is being administered.
8. To disconnect, turn the main switch to the symbol "O" position which represents off, then remove plug from outlet.
9. Do not unplug by pulling on cord. To unplug, grasp the plug, not the cord.
10. Keep fingers away from all moving parts. Special care is required around the machine needle.
11. Always use the proper needle plate. The wrong plate can cause the needle to break.
12. Do not use bent needles.
13. Do not pull or push fabric while stitching. It may deflect the needle causing it to break.
14. Switch the machine to the symbol "O" position when making any adjustments in the needle area, such as threading needle, changing needle, threading bobbin, or changing presser foot, and the like.
15. Always unplug the machine from the electrical outlet when removing covers, lubricating, or when making any other user servicing adjustments mentioned in the instruction manual.
16. This sewing machine is not intended for use by young children or infirm persons without supervision.
17. Young children should be supervised to ensure that they do not play with this machine.
18. If the Light unit is damaged, it must be replaced by authorized dealer.

**SAVE THESE INSTRUCTIONS**  
**This machine is intended for household use.**

## FOR USERS IN THE UK, EIRE, MALTA AND CYPRUS ONLY

If this machine is fitted with a three-pin non-rewireable BS plug then please read the following.

### IMPORTANT

If the available socket outlet is not suitable for the plug supplied with this equipment, it should be cut off and an appropriate three-pin plug fitted. With alternative plugs an approved fuse must be fitted in the plug.

### NOTE

The plug served from the main lead must be destroyed as a plug with bared flexible cords is hazardous if engaged in a live socket outlet. In the event of replacing the plug fuse, use a fuse approved by ASTA to BS 1362, i.e. carrying the  mark, rating as marked on plug. Always replace the fuse cover, never use plugs with the fuse cover omitted.

### WARNING

**DO NOT CONNECT EITHER WIRE TO THE EARTH TERMINAL WHICH IS MARKED WITH THE LETTER 'E', BY THE EARTH SYMBOL  OR COLOURED GREEN OR GREEN AND YELLOW.**

The wires in this main lead are colored in accordance with the following code:

Blue	Neutral
Brown	Live

As the colors of the wiring in the main lead of this appliance may not correspond with the colored markings identifying the terminals in your plug, proceed as follows.

The wire which is colored blue must be connected to the terminal which is marked with the letter 'N' or colored black or blue.

The wire which is colored brown must be connected to the terminal which is marked with the letter 'L' or colored red or brown.

# CONGRATULATIONS ON CHOOSING OUR MACHINE

Your machine is one of the most advanced computerized household sewing machines. To fully enjoy all the features, we suggest that you study the manual before using the machine.

## PLEASE READ BEFORE USING THIS MACHINE

### For safe operation

1. Be sure to keep your eye on the needle while sewing. Do not touch the hand wheel, thread take-up lever, needle, or other moving parts.
2. Remember to turn off the power switch and unplug the cord when:
  - Operation is completed
  - Replacing or removing the needle or any other parts
  - A power failure occurs during use
  - Maintaining the machine
  - Leaving the machine unattended
3. Do not store anything on the foot controller.
4. Plug the machine directly into the wall. Do not use extension cords.

### For a longer service life

1. When storing this machine, avoid direct sunlight and high humidity locations. Do not use or store the machine near a space heater, iron, halogen lamp, or other hot objects.
2. Use only neutral soaps or detergents to clean the case. Benzene, thinner, and scouring powders can damage the case and machine, and should never be used.
3. Do not drop or hit the machine.
4. Always consult the operation manual when replacing or installing any assemblies, the presser feet, needle, or other parts to assure correct installation.

### For repair or adjustment

In the event a malfunction occurs or adjustment is required, first follow the troubleshooting table in the back of the operation manual to inspect and adjust the machine yourself. If the problem persists, please consult your local authorized Brother dealer.

**For additional product information and updates, visit our web site at [www.brother.com](http://www.brother.com)**

**1**

# GETTING READY

The various preparations required before starting to sew are described in this chapter.

- Turning the Machine On/Off ..... 10
- Winding/Installing the Bobbin ..... 12
- Upper Threading ..... 18
- Replacing the Needle ..... 26
- Replacing the Presser Foot ..... 29
- Sewing Cylindrical or Large Pieces..... 33

## Turning the Machine On/Off

This section explains how to turn the sewing machine on and off.

### Power supply precautions

Be sure to observe the following precautions concerning the power supply.

#### WARNING

- Use only regular household electricity for the power source. Using other power sources may result in fire, electric shock, or damage to the machine.
- Turn off the main power and remove the plug in the following circumstances:
  - When you are away from the machine
  - After using the machine
  - When the power fails during use
  - When the machine does not operate correctly due to a bad connection or a disconnection
  - During electrical storms

#### CAUTION

- Do not use extension cords or multi-plug adapters with many other appliances plugged in to them. Fire or electric shock may result.
- Do not touch the plug with wet hands. Electric shock may result.
- When unplugging the machine, always turn off the main power first. Always grasp the plug to remove it from the outlet. Pulling on the cord may damage the cord, or lead to fire or electric shock.
- Do not allow the power cord to be cut, damaged, modified, forcefully bent, pulled, twisted, or bundled. Do not place heavy objects on the cord. Do not subject the cord to heat. These things may damage the cord and cause fire or electric shock. If the cord or plug is damaged, take the machine to your authorized dealer for repairs before continuing use.
- Unplug the power cord if the machine is not to be used for a long period of time. Otherwise a fire may result.



## Turning on the machine

- 1 Make sure that the sewing machine is turned off (the main power switch is set to "O"), and then plug the power supply cord into the power supply jack on the right side of the machine.
- 2 Insert the plug of the power supply cord into a household electrical outlet.

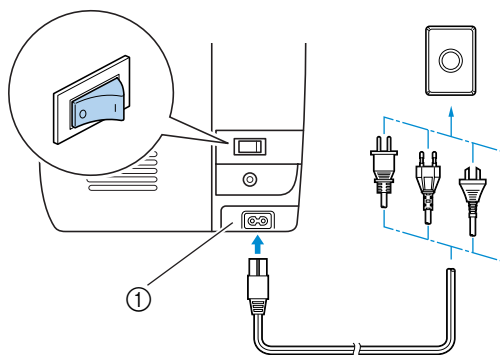

① Power supply jack

- 3 Press the right side of the main power switch on the right side of the machine (set it to "I").

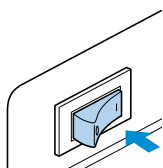

- ▶ The sewing lamp comes on when the machine is turned on.

## Turning off the machine

When you are finished using the sewing machine, turn it off. In addition, before transporting the sewing machine to another location, be sure to turn it off.

- 1 Make sure that the machine is not sewing.
- 2 Press the left side of the main power switch on the right side of the machine (set it to "O").

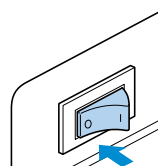

- ▶ The sewing lamp goes off when the machine is turned off.

- 3 Unplug the power supply cord from the electrical outlet.  
Grasp the plug when unplugging the power supply cord.
- 4 Unplug the power supply cord from the power supply jack.

### Note

- When the sewing machine is turned off, all stitch settings are cancelled.
- If a power outage occurs while the sewing machine is being operated, turn off the sewing machine and unplug the power supply cord. When restarting the sewing machine, follow the necessary procedure to correctly operate the machine.

(For U.S.A. only)

- This appliance has a polarized plug (one blade wider than the other). To reduce the risk of electrical shock, this plug is intended to fit in a polarized outlet only one way. If the plug does not fit fully in the outlet, reverse the plug. If it still does not fit, contact a qualified electrician to install the proper outlet. Do not modify the plug in any way.

## Winding/Installing the Bobbin

This section describes how to wind the thread onto the bobbin, and then insert the bobbin thread.

### Bobbin precautions

Be sure to observe the following precautions concerning the bobbin.

#### ! CAUTION

- Only use the bobbin (part code: SA156, XA5539-151) designed specifically for this sewing machine. Use of any other bobbin may result in injuries or damage to the machine.
- The enclosed bobbin was designed specifically for this sewing machine. If bobbins from older models are used, the machine will not operate correctly. Use only the enclosed bobbin or bobbins of the same type (part code: SA156, XA5539-151).

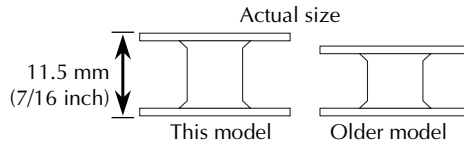

### Winding the bobbin

Wind the thread around the bobbin to prepare the bobbin thread.

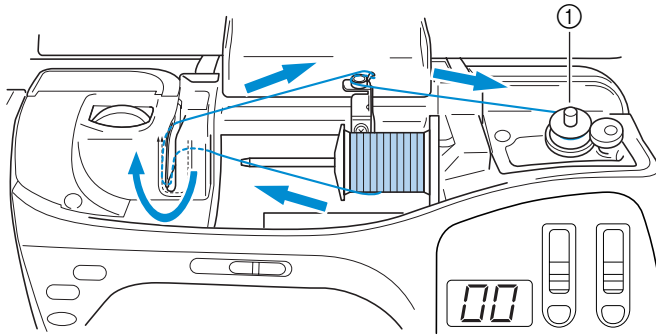

① Bobbin winder



#### Memo

- The order that the machine should be threaded for winding the bobbin is indicated by a broken line on the sewing machine. Be sure to thread the machine as indicated.

- 1 Turn on the sewing machine.**

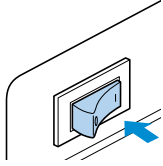

- 2 Lift open the upper cover.**

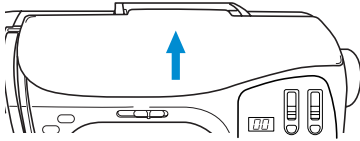

- 3 Place the bobbin on the bobbin winder shaft so that the spring on the shaft fits into the notch in the bobbin.**

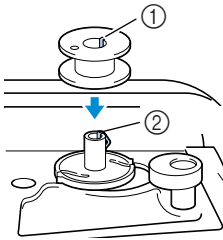

- ① Notch  
② Bobbin winder shaft spring

- 4 Slide the bobbin winder shaft to the right.**

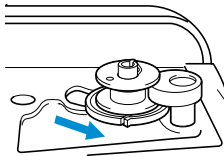

- 5 Remove the spool cap that is inserted onto the spool pin.**

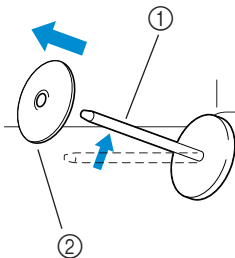

- ① Spool pin  
② Spool cap

- 6 Place the spool of thread for the bobbin onto the spool pin.**

Slide the spool onto the pin so that the spool is horizontal and the thread unrolls from the bottom front of the spool.

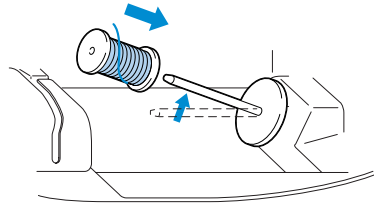

- If the spool is not positioned so that the thread unrolls correctly, the thread may become tangled around the spool pin.

- 7 Slide the spool cap onto the spool pin.**

With the rounded side of the spool cap positioned toward the left, slide the spool cap onto the spool pin as far as possible until the right side of the spool touches the right end of the spool pin.

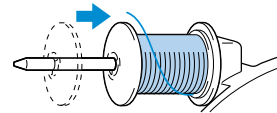

- Three spool cap sizes are available (large, medium and small). Use the spool cap with a diameter that is slightly larger than the diameter of the spool. The medium-sized spool cap is already on the spool pin when the sewing machine is purchased.

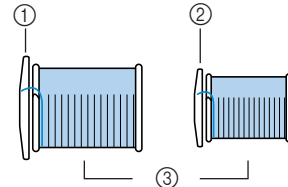

- ① Spool cap (large)  
② Spool cap (medium)  
③ Spool

- When using a spool of cross-wound thread, install the small spool cap with some space between the cap and the spool.

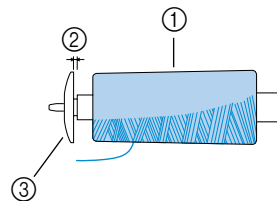

- ① Spool  
② Gap  
③ Spool cap (small)

**! CAUTION**

- If the spool or the spool cap is not positioned correctly, the thread may become tangled around the spool pin or the needle may break.
- Three spool cap sizes are available (large, medium and small), allowing you to choose a spool cap that best fits the size of spool being used. If the spool cap is too small for the spool being used, the thread may catch on the slit in the spool or the needle may break.

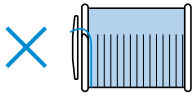

- 8** While holding the spool with your right hand, pull the thread with your left hand, and then pass the thread behind the thread guide cover to the front.

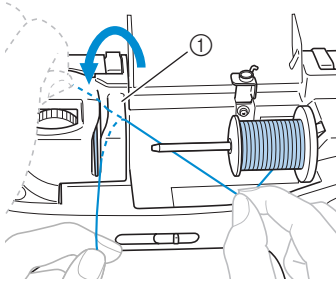

① Thread guide cover

- 9** Pass the thread under the thread guide plate from the right.

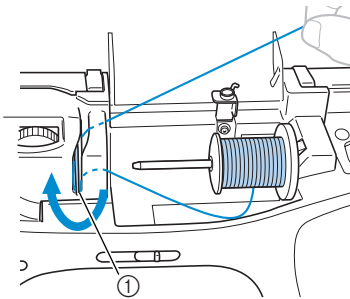

① Thread guide plate

- 10** Pull the thread to the right, pass it under the hook on the thread guide for bobbin winding, and then wind it counterclockwise between the discs.

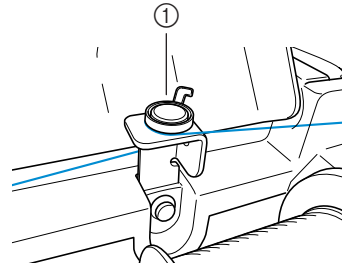
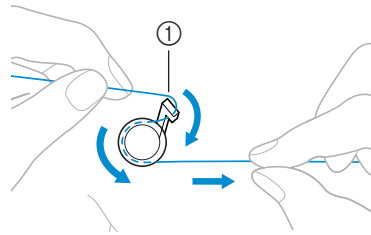

① Thread guide for bobbin winding

- 11** While using your left hand to hold the end of the thread that wraps around the thread guide for bobbin winding, use your right hand to wind the free end of the thread clockwise around the bobbin four or five times.

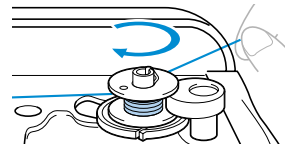

- 12** Pull the thread to the right and pass it through the slit in the bobbin winder seat.

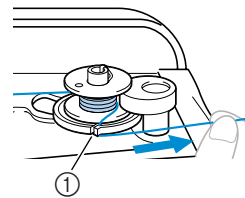

① Slit in bobbin winder seat (with built-in cutter)

- ▶ The thread is cut to a suitable length.

**! CAUTION**

- Be sure to cut the thread as described on the previous page. If the bobbin is wound without cutting the thread using the cutter built into the slit in the bobbin winder seat, the thread may become tangled in the bobbin or the needle may bend or break when the bobbin thread starts to run out.

- 13** Slide the sewing speed controller to the right (so that the speed will be fast).

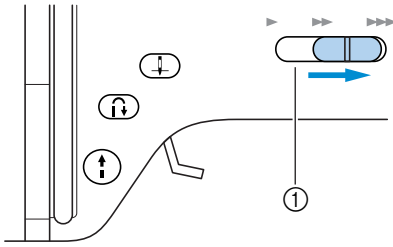

① Sewing speed controller

- 14** Press  (start/stop button) once.

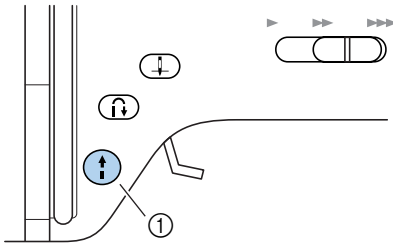

① Start/stop button

- ▶ The bobbin starts spinning and the thread is wound around the bobbin.
- ▶ The bobbin stops spinning when it is full.

- 15** Press  (start/stop button) once.

- ▶ The sewing machine stops.

- 16** Use scissors to cut the end of the thread wound around the bobbin.

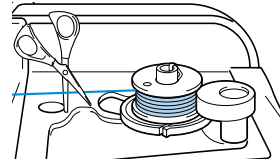

- 17** Slide the bobbin winder shaft to the left.

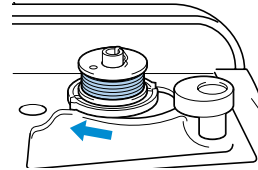

- 18** Remove the bobbin from the shaft.

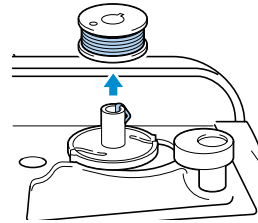

- 19** Slide the sewing speed controller back to its original position.

**! CAUTION**

- Use a bobbin thread that has been correctly wound, otherwise the needle may break or the thread tension will be incorrect.

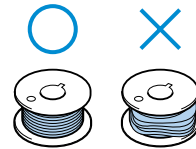
**Memo**

- When the sewing machine is started or the balance wheel is turned after winding the thread around the bobbin, the machine will make a clicking sound; this is not a malfunction.

## Installing the bobbin

Install the bobbin wound with thread.

### CAUTION

- Use a bobbin thread that has been correctly wound, otherwise the needle may break or the thread tension will be incorrect.

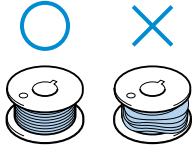

- The bobbin was designed specifically for this sewing machine. If bobbins from older models are used, the machine will not operate correctly. Use only the enclosed bobbin or bobbins of the same type (part code: SA156, XA5539-151).

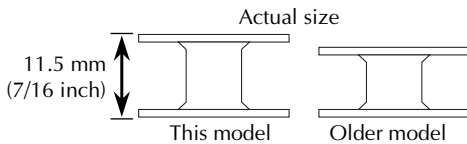

### Memo

- The order that the bobbin thread should be passed through the shuttle is indicated by marks around the shuttle. Be sure to thread the machine as indicated.

- 1 Slide the bobbin cover latch to the right.

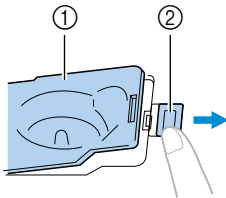

- 1 Bobbin cover
- 2 Latch

▶ The bobbin cover opens.

- 2 Remove the bobbin cover.

- 3 Hold the bobbin with your right hand and hold the end of the thread with your left.

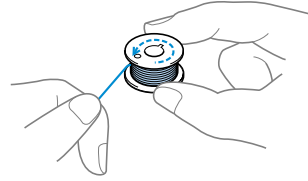

- Be careful not to drop the bobbin.

- 4 Insert the bobbin into the shuttle so that the thread unrolls to the left.

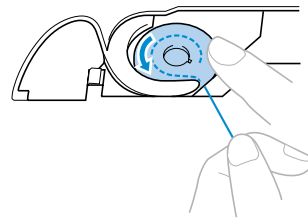

- Be sure to insert the bobbin correctly.

- 5 Lightly hold down the bobbin with your right hand, and then guide the thread as shown with your left hand.

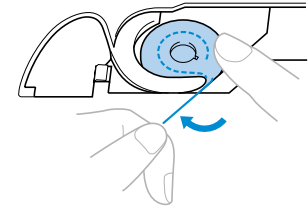

- 6 Pass the thread through the slot as shown, and then pull the thread out toward the front.

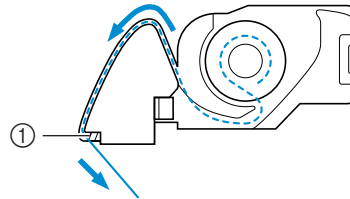

- 1 Cutter

▶ The cutter cuts the thread.

**! CAUTION**

- Be sure to hold down the bobbin with your finger and unroll the bobbin thread correctly, otherwise the thread may break or the thread tension will be incorrect.

**7 Reattach the bobbin cover.**

Insert the tab in the lower-left corner of the bobbin cover, and then lightly press down on the right side.

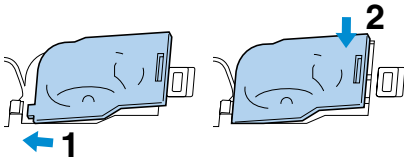

- ▶ The lower threading is finished.

Next, thread the upper thread. Continue with the procedure in “Upper Threading” (on the next page).

**🔔 Memo**

- You can begin sewing without pulling up the bobbin thread. If you wish to pull up the bobbin thread before starting to sew, pull up the thread according to the procedure in “Pulling up the bobbin thread” (page 25).

## Upper Threading

In this section, the procedures for positioning the spool for the upper thread and threading the needle are described.

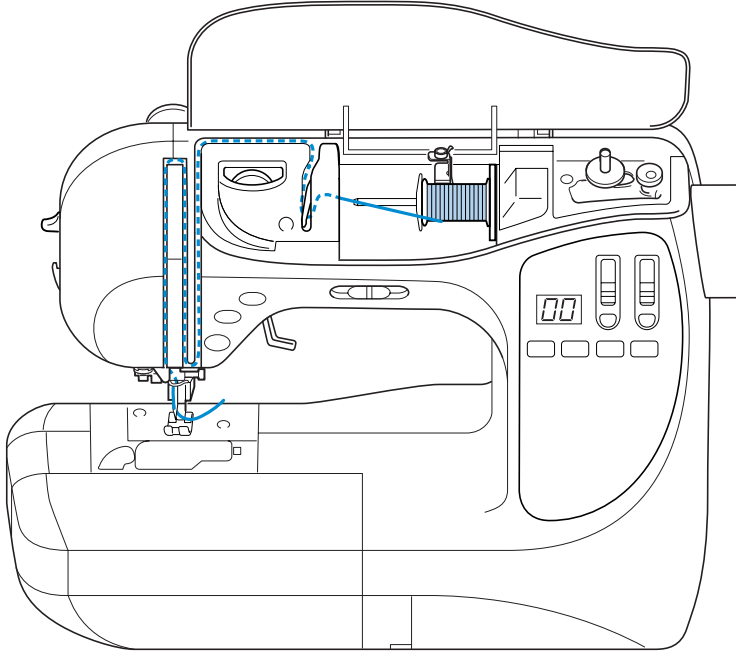

### CAUTION

- When threading the upper thread, carefully follow the instructions. If the upper threading is not correct, the thread may become tangled or the needle may bend or break.



### Memo

- The order that the machine should be threaded is indicated by a solid line on the sewing machine. Be sure to thread the machine as indicated.

### Threading the upper thread

- 1 Turn on the sewing machine.

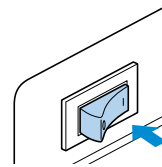

- 2 Raise the presser foot lever.

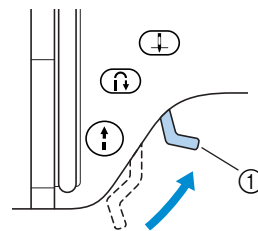

① Presser foot lever

▶ The presser foot is raised.



- If the presser foot is not raised, the sewing machine cannot be threaded correctly.

**3** Press  (needle position button) once or twice to raise the needle.

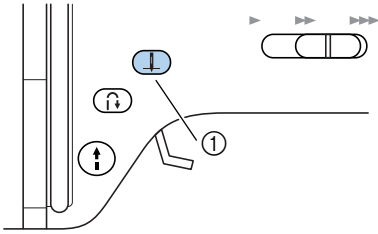

① Needle position button

- If the needle is not correctly raised, the sewing machine cannot be threaded. Check that the mark on the balance wheel is facing up as shown in the illustration below. If the balance wheel is not in this position, be sure to press the needle position button to raise the needle before using the needle threader.

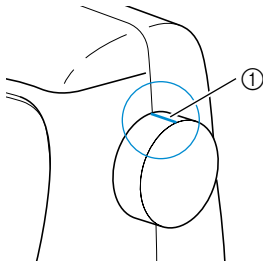

① Mark on balance wheel

**4** Lift open the upper cover.

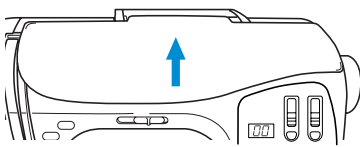

**5** Remove the spool cap that is inserted onto the spool pin.

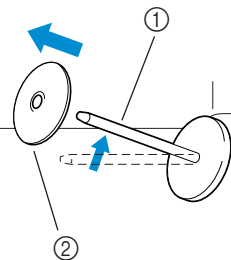

① Spool pin  
② Spool cap

**6** Place the spool for the upper thread onto the spool pin.

Slide the spool onto the pin so that the spool is horizontal and the thread unrolls from the bottom front of the spool.

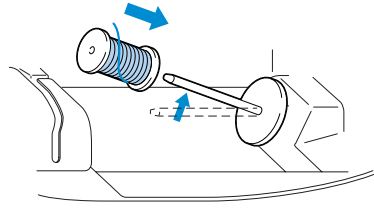

- If the spool is not positioned so that the thread unrolls correctly, the thread may become tangled around the spool pin.

**7** Slide the spool cap onto the spool pin.

With the rounded side of the spool cap positioned toward the left, slide the spool cap onto the spool pin as far as possible until the right side of the spool touches the right end of the spool pin.

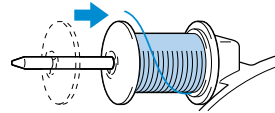

- Three spool cap sizes are available (large, medium and small). Use the spool cap with a diameter that is slightly larger than the diameter of the spool. The medium-sized spool cap is already on the spool pin when the sewing machine is purchased.

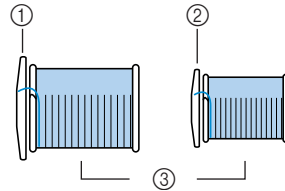

① Spool cap (large)  
② Spool cap (medium)  
③ Spool

- When using a spool of cross-wound thread, install the small spool cap with some space between the cap and the spool.

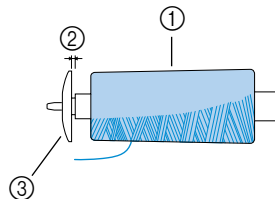

① Spool  
② Gap  
③ Spool cap (small)

**CAUTION**

- If the spool or the spool cap is not positioned correctly, the thread may become tangled around the spool pin or the needle may break.
- Three spool cap sizes are available (large, medium and small), allowing you to choose a spool cap that best fits the size of spool being used. If the spool cap is too small for the spool being used, the thread may catch on the slit in the spool or the needle may break.

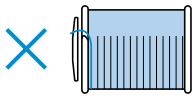

- 8** While holding the spool with your right hand, pull the thread with your left hand, and then pass the thread behind the thread guide cover to the front.

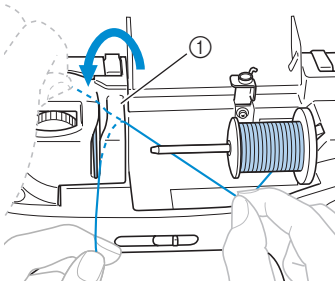

① Thread guide cover

- 9** Pass the thread under the thread guide plate from the right.

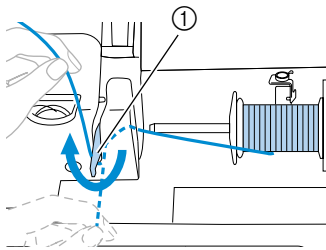

① Thread guide plate

- 10** While using your right hand to hold the thread passed under the thread guide plate taut, pass the thread through the guides in the order (up → left → down → up → down) shown.

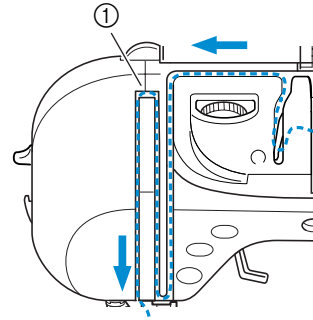

① Shutter

The following diagram shows the shutter position when the presser foot is lowered. Since the shutter is closed when the presser foot is lowered, the machine cannot be threaded. Be sure to raise the presser foot so that the shutter is open in order to thread the machine.

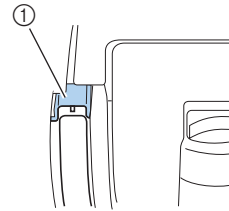

① Shutter

- 11** Pass the thread through the thread hook at the base of the needle bar.

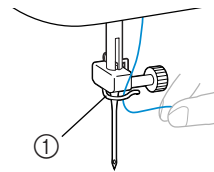

① Thread hook

Next, use the needle threader to thread the needle. Continue with the procedure in "Threading the needle" (on the next page).

## Threading the needle

The needle threader can be used with needle size 75/11 through 100/16. For more details on the needle, refer to "Needle types and their uses" (page 26).

- 1 With your left hand, hold the end of the thread passed through the needle bar thread hook, and then pass the thread through the thread guide discs from the front.

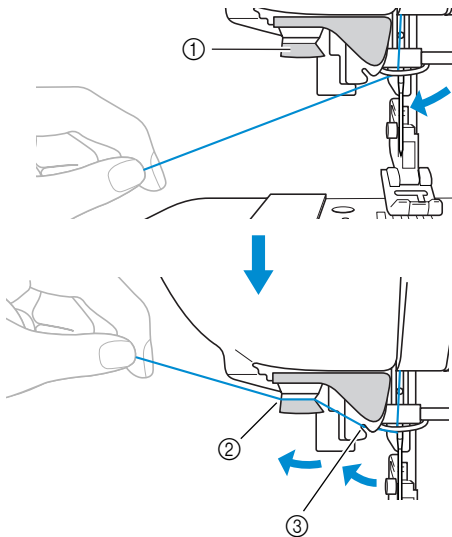

- 1 Thread guide discs
- 2 Pass to the back.
- 3 Pass through the slit.

- 2 Cut the thread with the cutter on the left side of the machine.

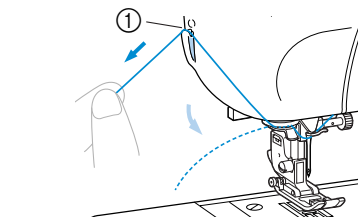

- 1 Thread cutter

- 3 Lower the presser foot lever.

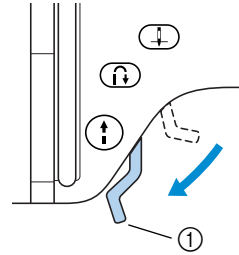

- 1 Presser foot lever
- The presser foot is lowered.

- 4 Lower the needle threader lever until it clicks.

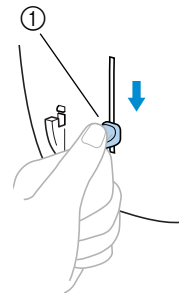

- 1 Needle threader lever
- The thread is passed through the eye of the needle.

- 5 Release the needle threader lever.

- 6 Carefully pull on the loop of thread passed through the eye of the needle to pull out the end of the thread.

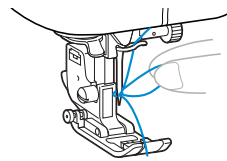

- 7** Raise the presser foot lever, pass the thread through the presser foot, and then pull out about 5 cm (2 inch) of thread toward the rear of the machine.

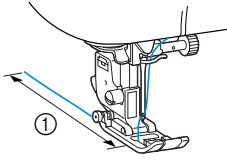

① 5 cm (2 inch)

- The upper threading is finished.

Now that the upper threading and the lower threading are finished, you are ready to begin sewing.



### Note

- If the needle is not raised, the needle threader cannot thread the needle. Be sure to press the needle position button to raise the needle before using the needle threader.
- If the twin needle is installed, the needle threader cannot be used. For details, refer to "Using the twin needle" (at the right).

## Using the twin needle

With the twin needle, you can sew two parallel lines of the same stitch with two different threads. Both upper threads should have the same thickness and quality. Be sure to use the twin needle, the extra spool pin and the spool cap. For details on the stitches that can be sewn with the twin needle, refer to "Stitch Settings" (page 92).

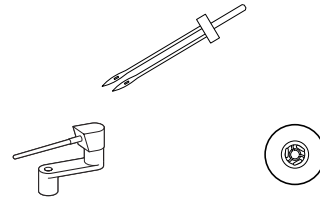

### ! CAUTION

- **Only use the twin needle (part code: X59296-051). Use of any other needle may bend the needle or damage the machine.**
- **Never use bent needles. Bent needles can easily break, possibly resulting in injuries.**

- 1 Install the twin needle.**
  - For details on installing a needle, refer to "Replacing the needle" (page 28).
- 2 Thread the upper thread for the left needle eye.**
  - For details, refer to steps ① through ⑪ of "Threading the upper thread" (page 18).
- 3 Manually thread the left needle with the upper thread.**

Pass the thread through the eye of the needle from the front.

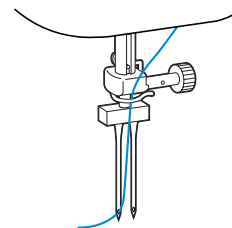

- The needle threader cannot be used with the twin needle. If the needle threader is used with the twin needle, the sewing machine may be damaged.

**4** Insert the extra spool pin onto the bobbin winder shaft.

Insert the extra spool pin so that it is perpendicular to the bobbin winder shaft.

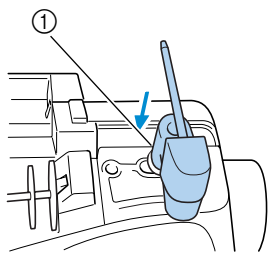

① Bobbin winder shaft

**5** Swing down the spool pin so that it is horizontal.

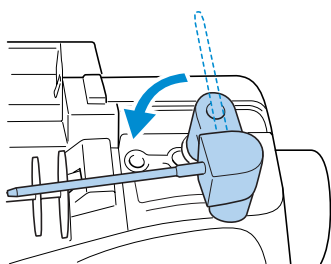

**6** Place the upper thread spool for the needle on the right side onto the extra spool pin, and then secure it with the spool cap.

The thread should unroll from the top front of the spool.

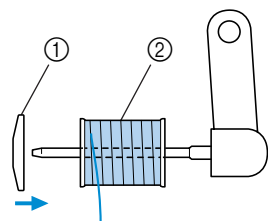

① Spool cap  
② Spool

**7** Thread the upper thread in the same way that the upper thread for the left side was threaded.

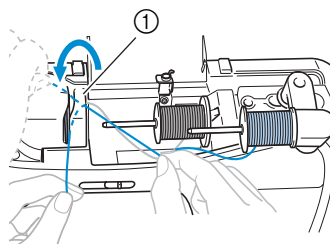

① Thread guide cover

• For details, refer to step **8** through **10** of “Threading the upper thread” (page 20).

**8** Without passing the thread through the needle bar thread hook, manually thread the right needle.

Pass the thread through the eye of the needle from the front.

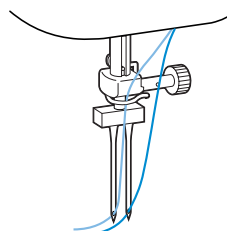

• The needle threader cannot be used with the twin needle. If the needle threader is used with the twin needle, the sewing machine may be damaged.

**9** Attach zigzag foot “J”.

• For details on changing the presser foot, refer to “Replacing the presser foot” (page 29).

**CAUTION**

● When using the twin needle, be sure to attach zigzag foot “J”, otherwise the needle may break or the machine may be damaged.

**10** Turn on the sewing machine.

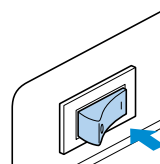

**11 Select a stitch.**

- For details on selecting a stitch, refer to “Selecting Stitching” (page 54).
- For details on the stitches that can be sewn with the twin needle, refer to “Stitch Settings” (page 92).
- Select a stitch width of 5.0 mm (3/16 inch) or less.

**CAUTION**

- When using the twin needle, be sure to select an appropriate stitch, otherwise the needle may break or the machine may be damaged.
- Select a stitch width of 5.0 mm (3/16 inch) or less, otherwise the needle may break or the machine may be damaged.
- After adjusting the stitch width, slowly turn the balance wheel toward you and check that the needle does not touch the presser foot. If the needle hits the presser foot, the needle may bend or break.

**12 Start sewing.**

- For details on starting to sew, refer to “Starting to sew” (page 39).
- ▶ Two lines of stitching are sewn parallel to each other.

**CAUTION**

- When changing the sewing direction, press  (needle position button) to raise the needle from the fabric, and then raise the presser foot lever and turn the fabric.

**Using thread that winds off quickly**

When using thread that winds off quickly, such as transparent nylon thread or metallic thread, place the enclosed spool net over the spool before placing the spool of thread onto the spool pin.

If the spool net is too long, fold it to fit the size of the spool.

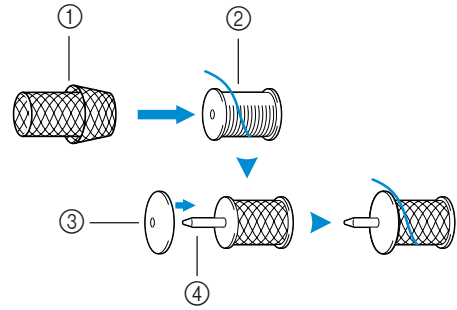

- ① Spool net
- ② Spool
- ③ Spool cap
- ④ Spool pin

## Pulling up the bobbin thread

When making gathers or before free-motion quilting, first pull up the bobbin thread as described below.

- 1 Insert the bobbin into the shuttle.**
  - Refer to steps 1 through 5 of "Installing the bobbin" (page 16).

- 2 Pass the bobbin thread through the slot.**

Do not cut the thread with the cutter.

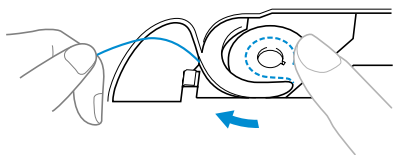

- 3 While lightly holding the upper thread with your left hand, press  (needle position button) twice to raise the needle.**

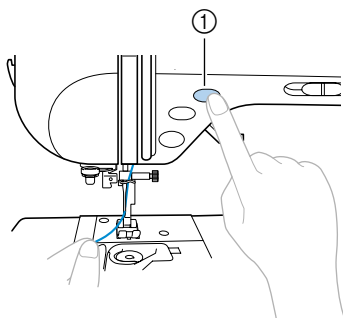

① Needle position button

- The bobbin thread is looped around the upper thread and can be pulled up.

- 4 Carefully pull the upper thread upward to pull out the end of the bobbin thread.**

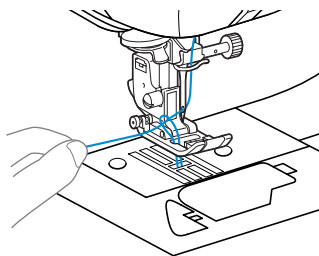

- 5 Pull out about 5 cm (2 inch) of the bobbin thread under the presser foot toward the rear of the machine.**

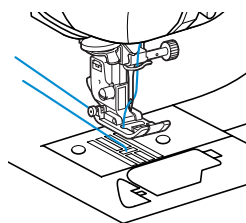

- 6 Reattach the bobbin cover.**

Insert the tab in the lower-left corner of the bobbin cover, and then lightly press down on the right side.

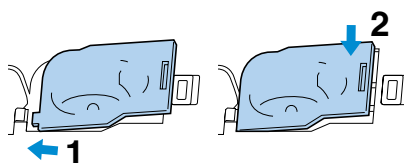

## Replacing the Needle

This section provides information on sewing machine needles.

### Needle precautions

Be sure to observe the following precautions concerning the handling of the needle. Failure to observe these precautions is extremely dangerous, for example, if the needle breaks and fragments are dispersed. Be sure to read and carefully follow the instructions below.



#### CAUTION

- Only use home sewing machine needles. Use of any other needle may bend the needle or damage the machine.
- Never use bent needles. Bent needles can easily break, possibly resulting in injuries.

### Needle types and their uses

The sewing machine needle that should be used depends on the fabric and thread thickness. Refer to the following table when choosing the thread and needle appropriate for the fabric that you wish to sew.

Fabric Type/Application		Thread		Size of Needle
		Type	Size	
Medium weight fabrics	Broadcloth	Cotton thread	60–80	75/11–90/14
	Taffeta	Synthetic thread		
	Flannel, Gabardine	Silk thread	50–80	
Thin fabrics	Lawn	Cotton thread	60–80	65/9–75/11
	Georgette	Synthetic thread		
	Challis, Satin	Silk thread	50–80	
Thick fabrics	Denim	Cotton thread	30–50	90/14–100/16
	Corduroy	Synthetic thread	50	
	Tweed	Silk thread		
Stretch fabrics	Jersey	Thread for knits	50–60	Ball point needle (golden colored) 75/11–90/14
	Tricot			
Easily frayed fabrics		Cotton thread	50–80	65/9–90/14
		Synthetic thread		
		Silk thread		
For top-stitching		Synthetic thread	30	90/14–100/16
		Silk thread		





## Memo

- The smaller the thread number, the thicker the thread, and the larger the needle number, the thicker the needle.
- Use the ball point needle when sewing on stretch fabrics or fabrics where skipped stitches easily occur.
- Use a 90/14 to 100/16 needle with transparent nylon threads, regardless of the fabric being sewn.
- A 75/11 needle is already installed when the sewing machine is purchased.



## CAUTION

- The appropriate fabric, thread and needle combinations are shown in the table on the previous page. If the combination of the fabric, thread and needle is not correct, particularly when sewing thick fabrics (such as denim) with thin needles (such as 65/9 to 75/11), the needle may bend or break. In addition, the stitching may be uneven or puckered or there may be skipped stitches.

## Checking the needle

Sewing with a bent needle is extremely dangerous since the needle may break while the machine is being operated.

Before using the needle, place the flat side of the needle on a flat surface and check that the distance between the needle and the flat surface is even.

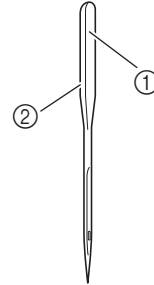

- ① Flat side
- ② Needle type marking

### ■ Correct needle

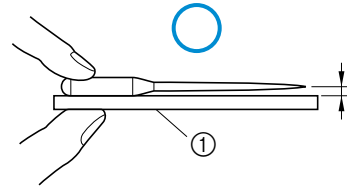

- ① Flat surface

### ■ Incorrect needle

If the distance between the needle and the flat surface is not even, the needle is bent. Do not use a bent needle.

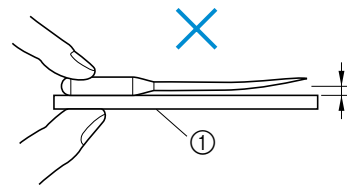

- ① Flat surface

## Replacing the needle

Replace the needle as described below. Use the screwdriver and a needle that has been determined to be straight according to the instructions in "Checking the needle".

- 1** Press  (needle position button) once or twice to raise the needle.

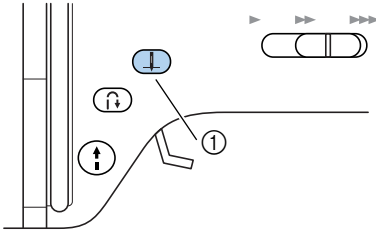

① Needle position button

- 2** Turn off the sewing machine.

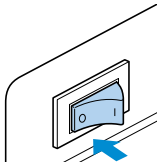

### CAUTION

- Before replacing the needle, be sure to turn off the sewing machine, otherwise injuries may occur if the start/stop button is accidentally pressed and the machine starts sewing.

- 3** Lower the presser foot lever.

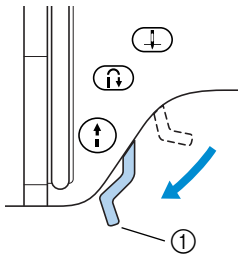

① Presser foot lever

- 4** Hold the needle with your left hand, and then use a screwdriver to turn the needle clamp screw counterclockwise to remove the needle.

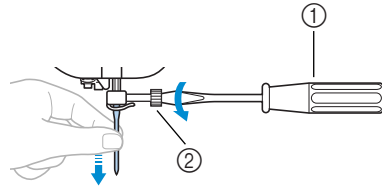

- ① Screwdriver  
② Needle clamp screw
- Do not apply a strong force when loosening or tightening the needle clamp screw, otherwise certain parts of the sewing machine may be damaged.

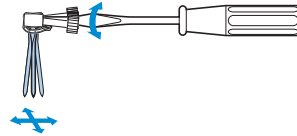

- 5** With the flat side of the needle toward the rear of the machine, insert the needle until it touches the needle stopper.

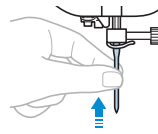

- 6** While holding the needle with your left hand, use the screwdriver to tighten the needle clamp screw.

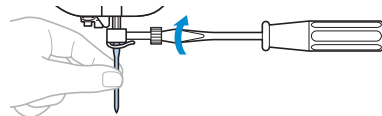

Install the twin needle in the same way.

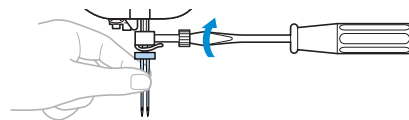

### CAUTION

- Be sure to insert the needle until it touches the needle stopper and securely tighten the needle clamp screw with the screwdriver, otherwise the needle may break or damage may result.

## Replacing the Presser Foot

The presser foot presses down on the fabric.

### Presser foot precautions

Be sure to observe the following precautions concerning the presser feet.

#### ! CAUTION

- Use the presser foot appropriate for the type of stitch that you wish to sew, otherwise the needle may hit the presser foot, causing the needle to bend or break.
- Only use presser feet designed specifically for this sewing machine. Use of any other presser foot may result in injuries or damage to the machine.

### Replacing the presser foot

Replace the presser foot as described below.

- 1 Press  (needle position button) once or twice to raise the needle.

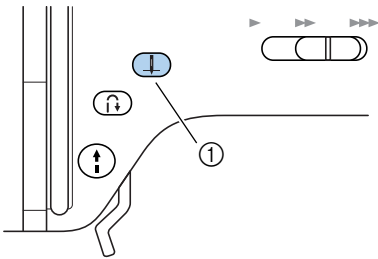

- ① Needle position button  
▶ The needle is raised.

- 2 Turn off the sewing machine.

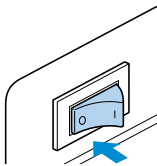

#### ! CAUTION

- Before replacing the presser foot, be sure to turn off the sewing machine, otherwise injuries may occur if the start/stop button is accidentally pressed and the machine starts sewing.

- 3 Raise the presser foot lever.

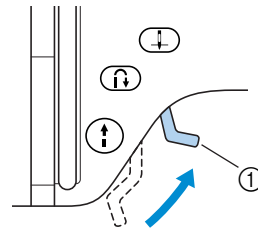

- ① Presser foot lever  
▶ The presser foot is raised.

- 4 Press the black button at the back of the presser foot holder.

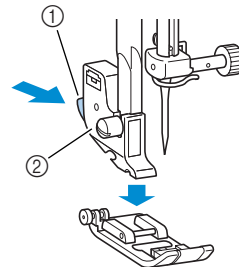

- ① Black button  
② Presser foot holder  
▶ The presser foot holder releases the presser foot.

- 5** Place a different presser foot below the holder so that the presser foot pin is aligned with the notch in the holder.

Position the presser foot so the letter indicating the presser foot type (A, G, I, J, M, N or R) is positioned to be read.

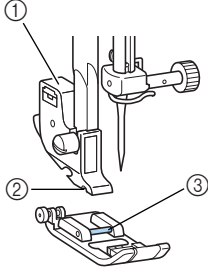

- ① Presser foot holder
- ② Notch
- ③ Pin

- 6** Slowly lower the presser foot lever so that the presser foot pin snaps into the notch in the presser foot holder.

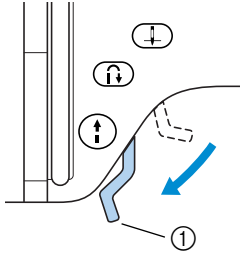

- ① Presser foot lever
- ▶ The presser foot is attached.

- 7** Raise the presser foot lever to check that the presser foot is securely attached.



### Note

- For details on the presser foot that should be used with the selected stitch, refer to “Stitch Settings” (page 92).

## Adjusting the pressure of the presser foot

The amount of pressure that the presser foot applies to the fabric can be adjusted.

- 1** Lower the presser foot lever.

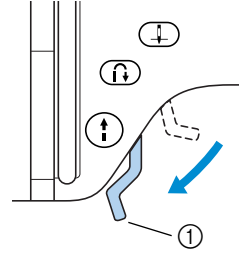

- ① Presser foot lever

- 2** Turn the presser foot dial at the back of the sewing machine.

The scale on the dial indicates the range from 1 (weak) to 4 (strong). Turn the dial to the right (smaller number) to decrease the pressure. Turn the dial to the left (large number) to increase the pressure.

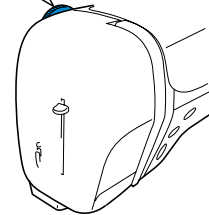
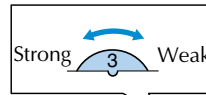

- 3** When you are finished sewing, reset the dial to 3 (standard).

## Removing the presser foot holder

Remove the presser foot holder when cleaning the sewing machine or when installing a presser foot that does not use the presser foot holder, such as the quilting foot. Use the screwdriver to remove the presser foot holder.

### ■ Removing the presser foot holder

- 1 **Remove the presser foot.**
  - For details, refer to “Replacing the presser foot” (page 29).

- 2 **Use the screwdriver to loosen the presser foot holder screw.**

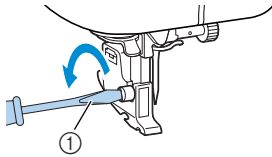

① Screwdriver

### ■ Attaching the presser foot holder

- 1 **Align the presser foot holder with the lower-left side of the presser bar.**

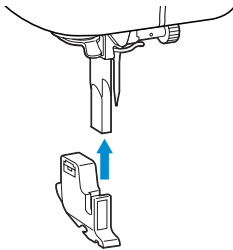

- 2 **Hold the presser foot holder in place with your right hand, and then tighten the screw using the screwdriver in your left hand.**

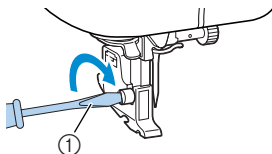

① Screwdriver



### Note

- If the presser foot holder is not correctly installed, the thread tension will be incorrect.

## Using the optional walking foot

With the walking foot, both pieces of fabric are fed evenly by the feed dogs and the teeth on the presser foot. This is useful when sewing fabrics that are hard to feed such as vinyl and leather and when sewing fabrics that easily slip such as velvets or when quilting.

Use the screwdriver to attach the walking foot.

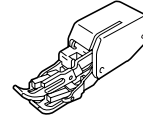

### ■ Attaching the walking foot

- 1 **Remove the presser foot holder.**
  - For details, refer to “Removing the presser foot holder” (at the left).

- 2 **Hook the connecting fork of the walking foot onto the needle clamp screw.**

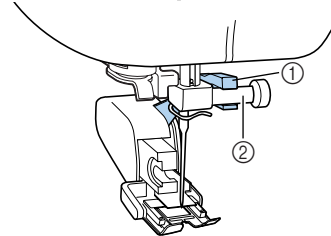

① Connecting fork  
② Needle clamp screw

- 3 **Lower the presser foot lever, insert the presser foot holder screw, and then tighten the screw with the screwdriver.**

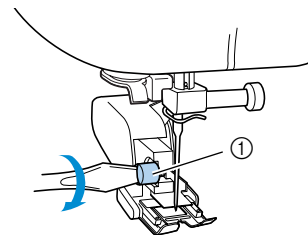

① Presser foot holder screw

**CAUTION**

- Be sure to securely tighten the screw with the screwdriver, otherwise the needle may touch the presser foot, causing it to bend or break.
- Before starting to sew, slowly turn the balance wheel toward you and check that the needle does not touch the presser foot. If the needle hits the presser foot, the needle may bend or break.

**Note**

- When sewing with the walking foot, sew at a speed between slow and medium.

**■ Removing the walking foot**

- ① Press (needle position button) once or twice to raise the needle.

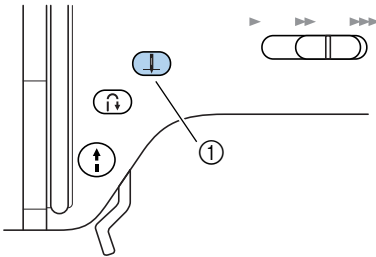

- ① Needle position button  
▶ The needle is raised.

- ② Turn off the sewing machine.

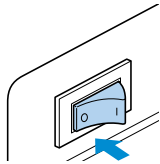

- ③ Raise the presser foot lever.

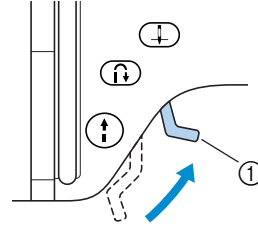

- ① Presser foot lever  
▶ The presser foot is raised.

- ④ With a screwdriver, loosen the presser foot holder screw, and then remove the walking foot.

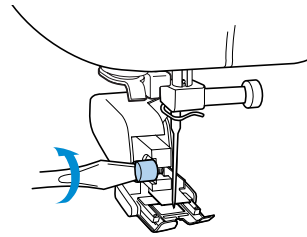

- ⑤ Attach the presser foot holder.
- For details, refer to “Removing the presser foot holder” (page 31).

**Memo**

- Only the straight stitch (with reinforcement stitching) and the zigzag stitch can be used with the walking foot. For details on the stitches, refer to “Stitch Settings” (page 92).

**Note**

- The optional walking foot is available through your brother retailer.

## Sewing Cylindrical or Large Pieces

When sewing cylindrical or large pieces of fabric, remove the flat bed attachment.

### Stitching cylindrical pieces

Removing the flat bed attachment makes it easier to sew cylindrical pieces such as cuffs and pant legs.

- 1 Pull the flat bed attachment off to the left.

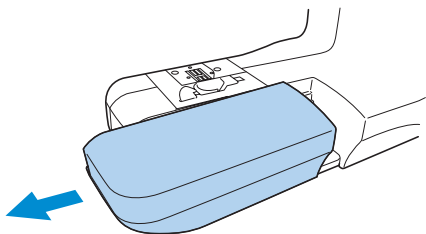

► With the flat bed attachment removed, free-arm sewing is possible.

- 2 Slide the part that you wish to sew onto the arm, and then sew from the top.

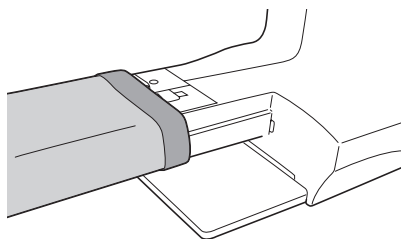

- 3 When you are finished with free-arm sewing, install the flat bed attachment back in its original position.

### Sewing large pieces of fabric

The optional wide table makes sewing large pieces of fabric easier.

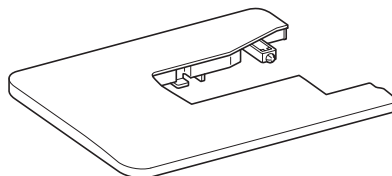

- 1 Open up the legs at the bottom of the wide table.  
Pull out the four legs until they snap into place.

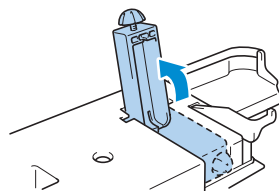

- 2 Pull the flat bed attachment off to the left.

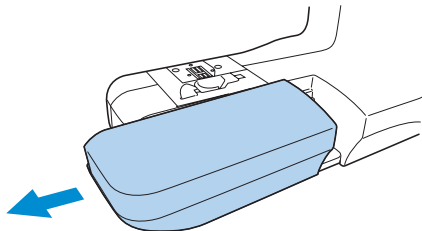

► With the flat bed attachment removed, free-arm sewing is possible.

- 3 Install the wide table.  
Keeping the wide table level, fully slide it into place.

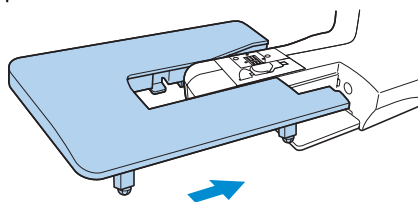

#### Note

- The optional wide table is available through your brother retailer.

- 4** Turn the screw at the bottom of the legs to adjust their height.

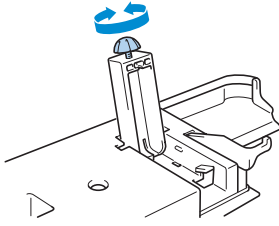

**! CAUTION**

- Do not move the sewing machine while the wide table is attached, otherwise damage or injuries may occur.

- 5** When you are finished using the wide table, remove it.  
While slightly lifting up the wide table, pull it off to the left.

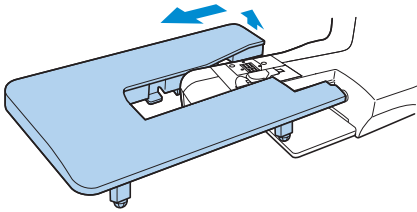

- 6** Install the flat bed attachment back in its original position.



**Memo**

- With the legs folded up, the wide table can be stored attached to the hard case.

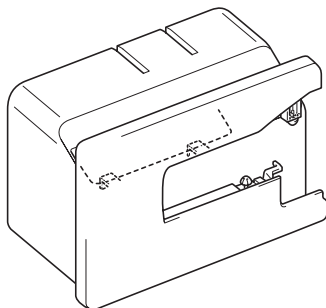



## 2

## SEWING BASICS

The necessary preparations for sewing are described in this chapter.

Sewing.....	36
Adjusting the Thread Tension.....	44
Adjusting the Stitch Width and Length.....	45
Useful Functions .....	47
Useful Sewing Tips .....	49

## Sewing

Basic sewing operations are described below.

Before operating the sewing machine, read the following precautions.



### CAUTION

- **While the machine is in operation, pay special attention to the needle location. In addition, keep your hands away from all moving parts such as the needle and balance wheel, otherwise injuries may occur.**
- **Do not pull or push the fabric too hard while sewing, otherwise injuries may occur or the needle may break.**
- **Never use bent needles. Bent needles can easily break, possibly resulting in injuries.**
- **Make sure that the needle does not strike basting pins, otherwise the needle may break or bend.**

## General sewing procedure

Follow the basic procedures below to sew.

<b>1</b>	<b>Turn on the machine.</b>	Turn on the sewing machine. For details on turning on the machine, refer to “Turning on the machine” (page 11).
↓		
<b>2</b>	<b>Select the stitch.</b>	Select the stitch appropriate for the area to be sewn. For details on selecting a stitch, refer to “Selecting stitching” (page 54).
↓		
<b>3</b>	<b>Attach the presser foot.</b>	Attach the presser foot appropriate for the stitch. For details on replacing the presser foot, refer to “Replacing the presser foot” (page 29).
↓		
<b>4</b>	<b>Position the fabric.</b>	Place the area to be sewn under the presser foot. Be sure that the fabric pieces are sewn in the correct order and that the right and wrong sides of the fabric are aligned correctly. For details on positioning the fabric, refer to “Positioning the fabric” (page 38).
↓		
<b>5</b>	<b>Start sewing.</b>	Start sewing. For details on starting to sew, refer to “Starting to sew” (page 39).
↓		
<b>6</b>	<b>Cut the thread.</b>	Cut the thread at the end of sewing. For details on cutting the thread, refer to “Cutting the thread” (page 43).

## Positioning the fabric

Be sure that the fabric pieces are sewn in the correct order and that the right and wrong sides of the fabric are aligned correctly.

### 1 Turn on the sewing machine.

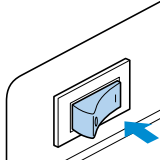

The straight stitch (left needle position) is automatically selected.

### 2 Press (needle position button) once or twice to raise the needle.

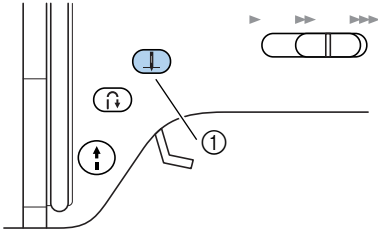

① Needle position button

### 3 Place the fabric under the presser foot.

- If the seam allowance is positioned on the right side, sewing in a straight line is easier and the extra fabric does not get in the way.

### 4 While holding the end of the thread and the fabric with your left hand, turn the balance wheel toward you with your right hand to lower the needle to the starting point of the stitching.

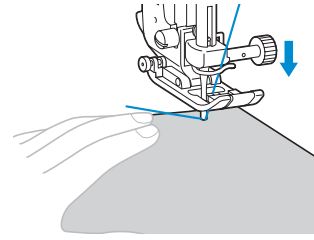
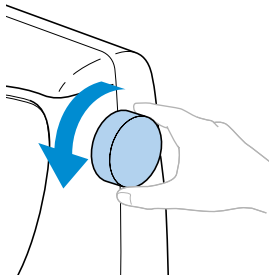

### 5 Lower the presser foot lever.

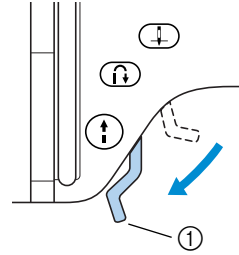

① Presser foot lever

- ▶ The fabric is now positioned to be sewn.

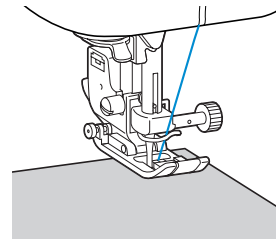

### Memo

- To adjust the pressure that the presser foot applies to the fabric, refer to “Adjusting the pressure of the presser foot” (page 30).

## Starting to sew

Once you are ready to start sewing, you can start the sewing machine. The sewing speed can be adjusted using either the operation buttons or the foot controller.

### ■ Using the operation buttons

Sewing can be started and stopped using the operation button  (start/stop button).

#### ① Slide the sewing speed controller to the left or right to select the desired sewing speed.

Slide the sewing speed controller to the left to sew at a slower speed, or slide the speed controller to the right to sew at a faster speed.

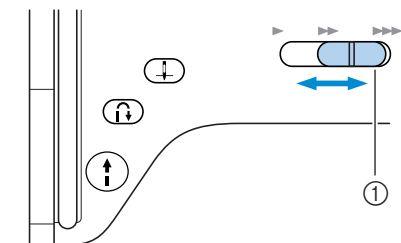

① Sewing speed controller

#### ② Press (start/stop button) once.

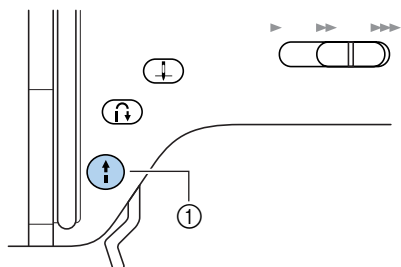

① Start/stop button

▶ The machine starts sewing.

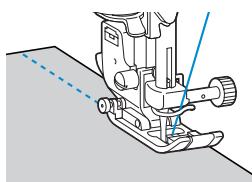

- If you continue to hold the start/stop button pressed immediately after the sewing starts, the machine will sew at a slow speed.

#### ③ When the end of the stitching is reached, press (start/stop button) once.

▶ The machine stops sewing with the needle down (in the fabric).

#### ④ When you are finished sewing, raise the needle, and then cut the threads.

- For details, refer to “Cutting the thread” (page 43).

### ■ Using the foot controller

Sewing can be started and stopped using the foot controller.

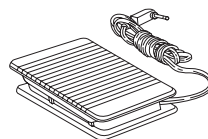

#### ① Turn off the sewing machine.

When connecting the foot controller, be sure to turn off the sewing machine in order to prevent the machine from accidentally being started.

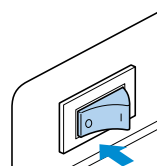

#### ② Insert the foot controller plug into its jack on the side of the sewing machine.

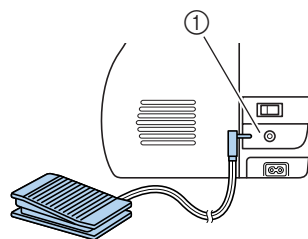

① Foot controller jack

### Note

(For U.S.A. only)

- Foot controller: Model N5V  
This foot controller can be used on this machine model NX-200/PC-210.

### 3 Turn on the sewing machine.

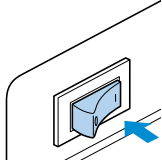

### 4 Slide the sewing speed controller to the left or right to select the desired sewing speed.

Slide the sewing speed controller to the left to sew at a slower speed, or slide the speed controller to the right to sew at a faster speed.

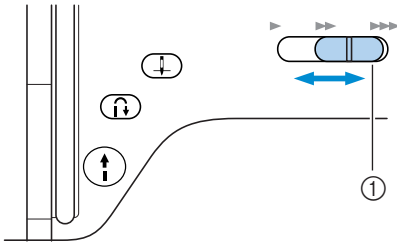

① Sewing speed controller

- The speed set using the sewing speed controller is the foot controller's maximum sewing speed.

### 5 Once you are ready to start sewing, slowly press down on the foot controller.

Pressing down on the foot controller increases the sewing speed; releasing the pressure on the foot controller decreases the sewing speed.

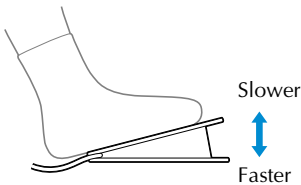

- Slowly press down on the foot controller. Pressing it down hard starts sewing too quickly.
- ▶ The machine starts sewing.

### 6 When the end of the stitching is reached, completely release the foot controller.

- ▶ The machine stops sewing with the needle lowered (in the fabric).

### 7 When you are finished sewing, raise the needle, and then cut the threads.

- For details, refer to "Cutting the thread" (page 43).

#### Memo

- If  (needle stop position key) is lit, the sewing machine will stop with the needle lowered. If the key is not lit, the sewing machine will stop with the needle raised. The needle position setting selected with the needle stop position key does not change if the sewing machine is turned off.
- When the foot controller is plugged in, the start/stop button cannot be used to start or stop sewing.

#### CAUTION

- Do not allow thread or dust to accumulate in the foot controller, otherwise a fire or an electric shock may occur.
- Do not place objects on the foot controller, otherwise damage to the machine or injuries may occur.
- If the machine is not to be used for a long period of time, unplug the foot controller, otherwise a fire or an electric shock may occur.

## Securing the stitching

When sewing with the straight stitch, for example, at the end of an opening or where seams do not overlap, use reverse stitching or reinforcement stitching to secure the end of the thread.

- 1 Lower the needle into the fabric at the beginning of the stitching, and then lower the presser foot lever.

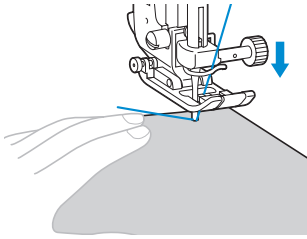

- 2 Press  (start/stop button) or press down on the foot controller.

At this time, if the start/stop button is held pressed, the machine sews at a low speed.

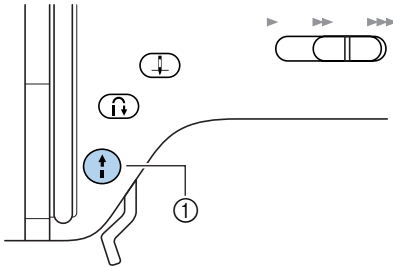

① Start/stop button

- For details, refer to “Starting to sew” (page 39).

- ▶ The machine starts sewing.

- 3 After sewing 3 to 5 stitches, press  (reverse/reinforcement stitch button). Keep the reverse/reinforcement stitch button held down until you reach the beginning of the stitching.

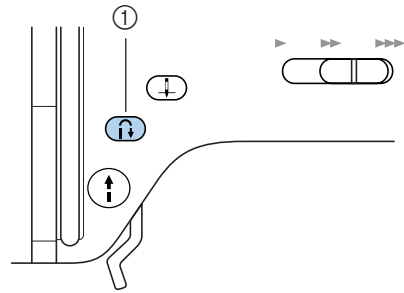

① Reverse/reinforcement stitch button

- ▶ While the reverse/reinforcement stitch button is held pressed, reverse stitches are sewn.

- 4 After sewing back to the beginning of the stitching, release the reverse/reinforcement stitch button.

- ▶ The machine stops sewing.

- 5 Press  (start/stop button), or press down on the foot controller.

- ▶ The machine starts sewing in the normal sewing direction.

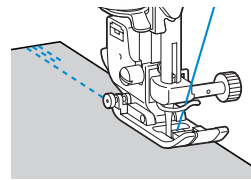

- 6 When the end of the stitching is reached, press  (reverse/reinforcement stitch button).

Keep the reverse/reinforcement stitch button held down until 3 to 5 reverse stitches are sewn.

- ▶ While the reverse/reinforcement stitch button is depressed, reverse stitches are sewn.

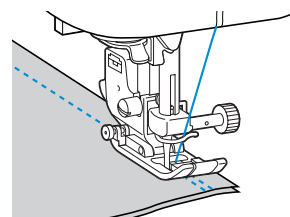

**7** After 3 to 5 reverse stitches have been sewn, release  (reverse/reinforcement stitch button).

▶ The machine stops sewing.

**8** Press  (start/stop button), or press down on the foot controller.

At this time, if the start/stop button is held pressed, the machine sews at a low speed.

▶ The machine starts sewing in the normal sewing direction.

**9** After sewing to the end of the stitching, the sewing machine stops.

Release the start/stop button or foot controller.

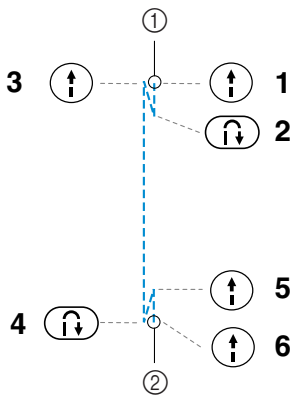

① Beginning of stitching  
② End of stitching

**■ Sewing reinforcement stitches**

When sewing stitches other than straight or zigzag stitches that are secured with reverse stitching, pressing  (reverse/reinforcement stitch button) sews reinforcement stitches, 3 to 5 stitches on top of each other.

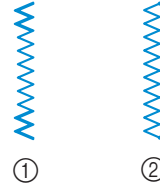

① Reverse stitching  
② Reinforcement stitching



**Memo**

- Whether reverse stitches or reinforcement stitches are sewn depends on the stitch that is selected. For details, refer to “Stitch Settings” (page 92).



## Cutting the thread

When you have finished sewing, cut the threads.

- 1 When you wish to finish the stitching and the sewing machine is stopped, press  (needle position button) once to raise the needle.

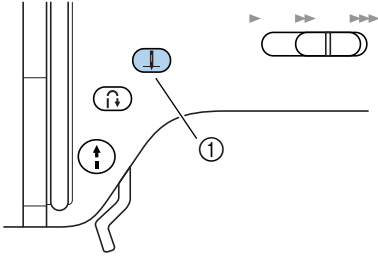

- 1 Needle position button
  - The needle is raised.

- 2 Raise the presser foot lever.

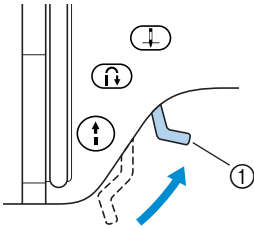

- 1 Presser foot lever

- 3 Pull the fabric to the left side of the machine, and then pass the threads through the thread cutter to cut them.

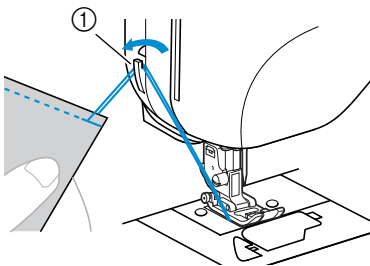

- 1 Thread cutter

## Adjusting the Thread Tension

The tensions of the upper thread and of the bobbin thread (thread tension) should be adjusted so that they are equal.

### Changing the tension of the upper thread

If the thread and needle combination is correct for the type of fabric being sewn (according to “Needle types and their uses” on page 26), the thread tension will automatically be adjusted to the appropriate setting. However, if the preset thread tension does not give the desired result or if you are sewing with special thread or on special fabric, use the thread tension dial under the upper cover to adjust the tension of the upper thread.

#### ■ Correct thread tension

The upper thread and the bobbin thread should cross near the center of the fabric. Only the upper thread should be visible from the right side of the fabric, and only the bobbin thread should be visible from the wrong side of the fabric.

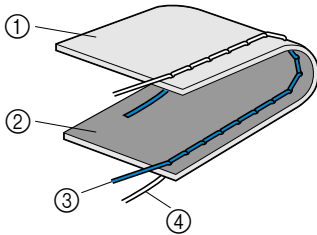

- ① Wrong side of fabric
- ② Right side of fabric
- ③ Upper thread
- ④ Bobbin thread

#### ■ Upper thread is too tight

If the bobbin thread is visible from the right side of the fabric, the upper thread is too tight.

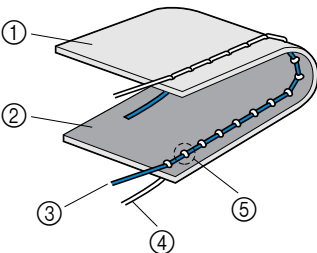

- ① Wrong side of fabric
- ② Right side of fabric
- ③ Upper thread
- ④ Bobbin thread
- ⑤ The bobbin thread is visible from the right side of the fabric.

Turn the thread tension dial to the left to loosen the upper thread.

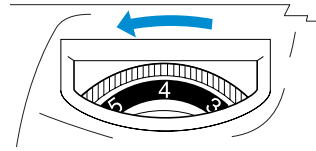

#### ■ Upper thread is too loose

If the upper thread is visible from the wrong side of the fabric, the upper thread is too loose.

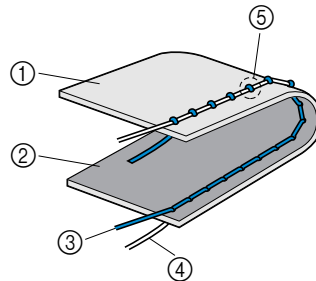

- ① Wrong side of fabric
- ② Right side of fabric
- ③ Upper thread
- ④ Bobbin thread
- ⑤ The upper thread is visible from the wrong side of the fabric.

Turn the thread tension dial to the right to tighten the upper thread.

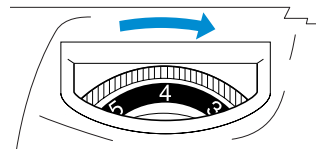

## Adjusting the Stitch Width and Length

The zigzag width (pattern width) and stitch length of utility stitches can be adjusted. Normally, when a stitch is selected, the appropriate width and length are automatically selected. For details on the range of values within which the width and length can be set, refer to “Stitch Settings” (page 92).

### Adjusting the stitch width

The stitch width can be adjusted with the arrow keys.

- 1 Press the stitch width adjustment button in the operation panel.
  - ▶ The stitch width adjustment button lights up.
- 2 Slide the stitch width adjustment slider up and down.
 

Sliding the stitch width adjustment slider up makes the stitch width wider; sliding the slider down makes the stitch width narrower.

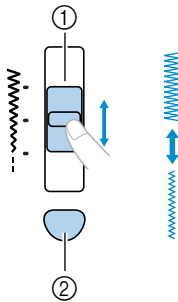

- ① Stitch width adjustment slider  
② Stitch width adjustment button

#### ■ Changing the needle position

With the straight stitch (left needle position) and the triple stretch stitch, the needle position can be adjusted. Sliding the stitch width adjustment slider up moves the needle to the right; sliding the slider down moves the needle to the left.

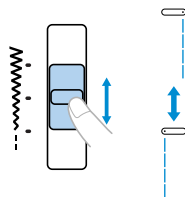

- To automatically select the stitch width most appropriate for the selected stitch, press the stitch width adjustment button again.

### ! CAUTION

- After adjusting the stitch width, slowly turn the balance wheel toward you and check that the needle does not touch the presser foot. If the needle hits the presser foot, the needle may bend or break.

## Adjusting the stitch length

The stitch length can be adjusted with the arrow keys.

### 1 Press the stitch length adjustment button in the operation panel.

► The stitch length adjustment button lights up.

### 2 Slide the stitch length adjustment slider up and down.

Sliding the stitch length adjustment slider up makes the stitching coarser; sliding the slider down makes the stitching finer.

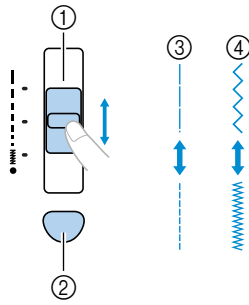

- ① Stitch length adjustment slider
- ② Stitch length adjustment button
- ③ Straight stitch
- ④ Zigzag stitch

- To automatically select the stitch length most appropriate for the selected stitch, press the stitch length adjustment button again.



### CAUTION

- **If the stitches are bunched together, increase the stitch length. Continuing to sew with the stitches bunched together may result in the needle bending or breaking.**

## Useful Functions

Functions useful in improving sewing efficiency are described below.

### Changing the needle stop position

The sewing machine can be set to leave the needle in the fabric (lowered needle stop position) or leave the needle raised (raised needle stop position) when sewing is stopped.

Press  (needle stop position key) in the operation panel to switch between the two settings.

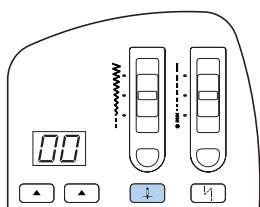

#### ■ For the lowered needle stop position

 (needle stop position key) is lit.

- When the sewing machine is purchased, it is set to the lowered needle stop position.

#### ■ For the raised needle stop position

 (needle stop position key) is not lit.



#### Memo

- The needle stop position setting does not change if the sewing machine is turned off.

### Automatically sewing reverse/reinforcement stitches

The sewing machine can be set to automatically sew reverse or reinforcement stitches at the beginning and end of the stitching.

Whether reverse stitches or reinforcement stitches are sewn depends on the stitch that is selected. For details, refer to “Stitch Settings” (page 92).

#### 1 Select a stitch.

- For details on selecting a stitch, refer to “Selecting stitching” (page 54).

#### 2 Press (automatic reverse/reinforcement stitch key) in the operation panel.

This step is not necessary if a stitch, such as those for sewing buttonholes, is selected where reinforcement stitches are automatically sewn.

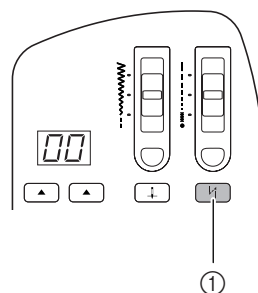

① Automatic reverse/reinforcement stitch key

► The automatic reverse/reinforcement stitch key lights up.

- To cancel automatic reverse/reinforcement stitching, press the automatic reverse/reinforcement stitch key again.

- 3** Position the fabric under the presser foot, and then press  (start/stop button) once.

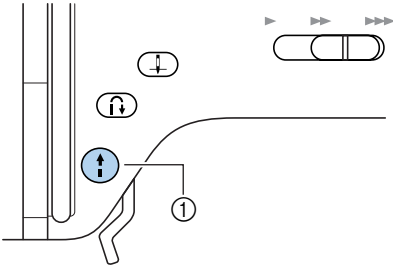

① Start/stop button

- After reverse/reinforcement stitches are sewn, the machine starts sewing.

- 4** After reaching the end of the stitching, press  (reverse/reinforcement stitch button) once.

This step is not necessary if a stitch such as those for sewing buttonholes and bar tacks is selected where reinforcement stitches are automatically sewn.

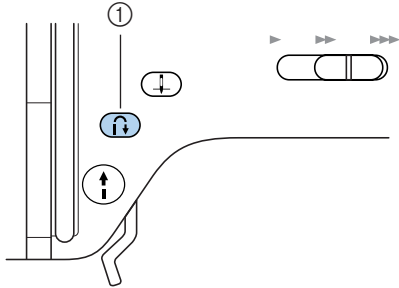

① Reverse/reinforcement stitch button

- After reverse/reinforcement stitches are sewn, the sewing machine stops.

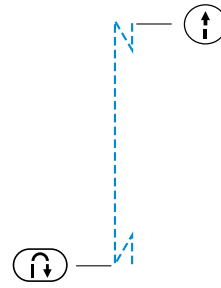

### Memo

- Reverse/reinforcement stitches will not be sewn if the start/stop button is pressed at the end of the stitching. Be sure to press the reverse/reinforcement stitch button at the end of the stitching.

## Useful Sewing Tips

Various ways to achieve better results for your sewing projects are described below. Refer to these tips when sewing your project.

### Trial sewing

After you have set up the machine with the thread and needle appropriate for the type of fabric being sewn, the machine automatically sets the thread tension and stitch length and width for the stitch that is selected. However, a trial piece of fabric should be sewn since, depending on the type of fabric and stitching being sewn, the desired results may not be achieved.

For the trial sewing, use a piece of fabric and thread that are the same as those used for your project, and check the thread tension and stitch length and width. Since the results differ depending on the type of stitching and the number of layers of fabric sewn, perform the trial sewing under the same conditions that will be used with your project.

### Changing the sewing direction

**1 When the stitching reaches a corner, stop the sewing machine.**

Leave the needle lowered (in the fabric). If the needle remained up when the machine stopped sewing, press  (needle position button) to lower the needle.

**2 Raise the presser foot lever, and then turn the fabric.**

Turn the fabric using the needle as a pivot.

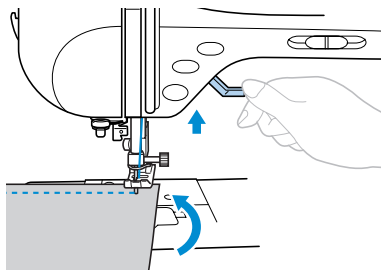

**3 Lower the presser foot lever and continue sewing.**

### Sewing curves

Stop sewing, and then slightly change the sewing direction to sew around the curve. For details on sewing with an even seam allowance, refer to “Sewing an even seam allowance” (page 51).

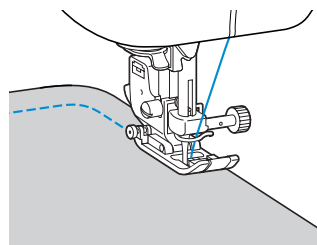

When sewing along a curve while using a zigzag stitch, select a shorter stitch length in order to obtain a finer stitch.

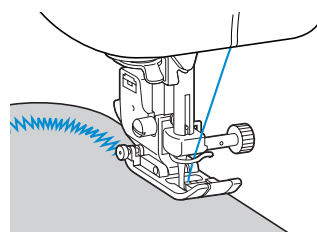

## Sewing thick fabrics

- **If the fabric does not fit under the presser foot**  
If the fabric does not fit easily under the presser foot, raise the presser foot lever even higher to bring the presser foot to its highest position.

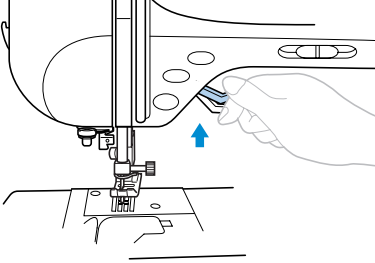

- **If thick seams are being sewn and the fabric does not feed at the beginning of stitching**  
Zigzag foot "J" is equipped with a feature that keeps the presser foot level.

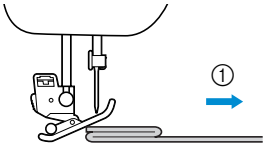

① Sewing direction

- ① **When you encounter a seam that is too thick to feed under the foot, raise the presser foot lever.**
- ② **Press the black button on the left side of the foot. Keep the button held in and lower the presser foot.**

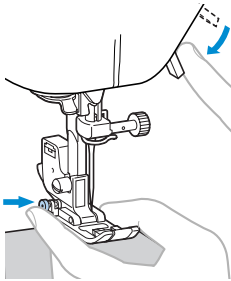

- ③ **Release the button. The foot will lock in place level with the seam, allowing the fabric to feed.**

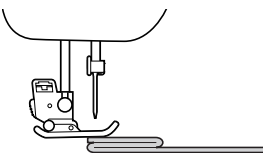

- Once the trouble spot has been passed, the foot will return to its normal position.

## ! CAUTION

- **If fabric more than 6 mm (15/64 inch) thick is sewn or if the fabric is pushed with too much force, the needle may bend or break.**



## Sewing thin fabrics

When sewing thin fabrics, the stitching may become misaligned or the fabric may not feed correctly. If this occurs, place thin paper or stabilizer material under the fabric and sew it together with the fabric. When you have finished sewing, tear off any excess paper.

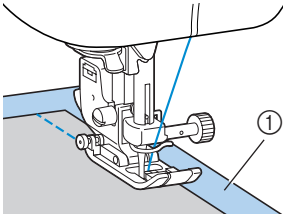

① Stabilizer material or paper

## Sewing stretch fabrics

First, baste the pieces of fabric together, and then sew without stretching the fabric.

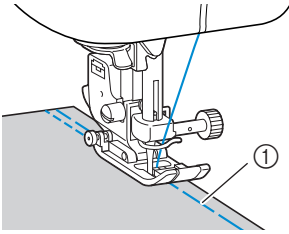

① Basting

## Sewing an even seam allowance

To sew an even seam allowance, start sewing so that the seam allowance is to the right of the presser foot, and the edge of the fabric is aligned with either the right edge of the presser foot or a marking on the needle plate.

### ■ Aligning the fabric with the presser foot

Sew while keeping the right edge of the presser foot a fixed distance from the edge of the fabric.

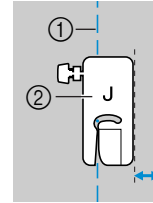

① Seam  
② Presser foot

### ■ Aligning the fabric with a needle plate marking

The markings on the needle plate show the distance from the needle position of a seam sewn with the straight stitch (left needle position). Sew while keeping the edge of the fabric aligned with a marking in the needle plate. The distance between the markings in the upper scale is 1/8 inch (3 mm) and the distance between the markings in the grid is 5 mm (3/16 inch).

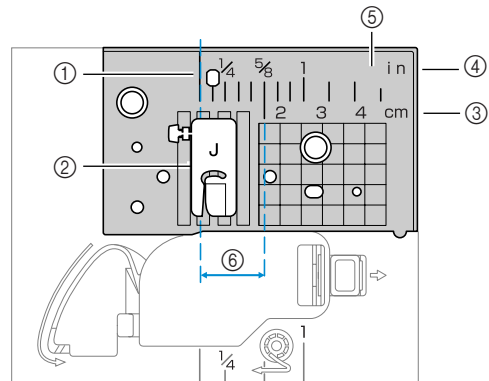

① Seam  
② Presser foot  
③ Centimeters  
④ Inches  
⑤ Needle plate  
⑥ 16 mm (5/8 inch)

CONTENTS

GETTING READY

SEWING BASICS

UTILITY STITCHES

APPENDIX

INDEX

## 3

**UTILITY STITCHES**

The various stitches and their applications are described in this chapter.

Selecting Stitching.....	54
Overcasting Stitches.....	56
Basic Stitching.....	60
Blind Hem Stitching .....	61
Buttonhole Stitching.....	63
Zipper Insertion .....	70
Sewing Stretch Fabrics and Elastic Tape.....	74
Applique, Patchwork and Quilt Stitching .....	76
Reinforcement Stitching.....	82
Eyelet Stitching.....	84
Decorative Stitching.....	85

## Selecting Stitching

You can select any of the various types of stitching available.

### Selecting stitching

Using the operation panel keys, select the desired stitch.

When the sewing machine is turned on, the straight stitch (00<sup>J</sup> left needle position) is selected.

A letter (A, G, J, M, N or R) indicating the presser foot that should be used appears to the right of the stitch number.

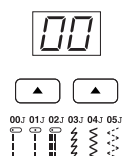

- 1 Determine the stitch that you wish to use.
- 2 Determine which presser foot should be used with the selected stitch.
  - The presser feet are stored in the accessory compartment.
    - For details on the stitches that can be sewn with the twin needle, refer to “Stitch Settings” (page 92).
- 3 Attach the presser foot.
  - For details, refer to “Replacing the presser foot” (page 29).
- 4 Turn on the sewing machine.

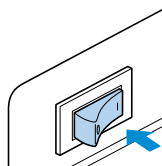

- ▶ When the machine is first turned on, “00” will be displayed.

- 5 Press (stitch selection key). The number of the selected stitch is displayed. Each press of increases the number by one. After “9” (“4” for the number on the left) is reached, the number returns to “0”. Pressing on the right changes the second digit (ones) and pressing on the left changes the first digit (tens).

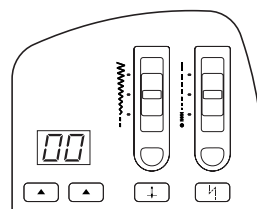

- ▶ The stitch is selected.

- 6 If necessary, specify the setting for automatic reverse/reinforcement stitching and adjust the stitch length, etc.
  - For details on sewing with each of the utility stitches, refer to the following pages.

■ [Example] Selecting stitch 04<sup>J</sup>

- 1 Press the stitch selection keys to select stitch 04.
  - With on the right, select “4”, and with on the left, select “0”.

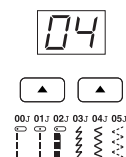

**2 To adjust the stitch width, slide the stitch width adjustment slider up or down.**

Press the stitch width adjustment button, and then slide the stitch width adjustment slider to adjust the stitch width.

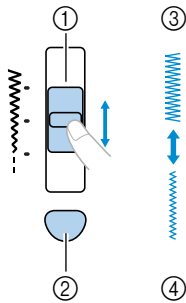

- ① Stitch width adjustment slider
- ② Stitch width adjustment button
- ③ Wide
- ④ Narrow

**3 To adjust the stitch length, slide the stitch length adjustment slider up or down.**

Press the stitch length adjustment button, and then slide the stitch length adjustment slider to adjust the stitch length.

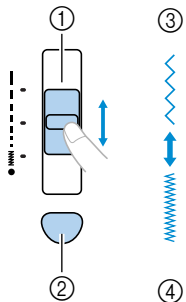

- ① Stitch length adjustment slider
- ② Stitch length adjustment button
- ③ Long
- ④ Short



**Memo**

- For details on adjusting the stitch width and length, refer to “Adjusting the Stitch Width and Length” (page 45).

# Overcasting Stitches

Sew overcasting stitches along the edges of cut fabric to prevent them from fraying. Seven stitches are available for overcasting. The procedure for sewing overcasting stitch is explained according to the presser foot that is used.

## Sewing overcasting stitches using overcasting foot “G”

Two stitches can be used to sew overcasting with overcasting foot “G”.

Stitch Name	Pattern	Application	Stitch Width [mm (inch.)]		Stitch Length [mm (inch.)]		Presser Foot
			Auto	Manual	Auto	Manual	
Overcasting stitch	06G 	Preventing fraying in medium weight and thin fabrics	3.5 (1/8)	2.5–5.0 (3/32–3/16)	2.0 (1/16)	1.0–4.0 (1/16–3/16)	G
	07G 	Preventing fraying in thick fabrics and fabrics that fray easily	5.0 (3/16)	2.5–5.0 (3/32–3/16)	2.5 (3/32)	1.0–4.0 (1/16–3/16)	

**1 Attach overcasting foot “G”.**

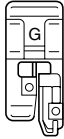

- For details, refer to “Replacing the presser foot” (page 29).

**2 Select a stitch.**

- For details, refer to “Selecting stitching” (page 54).

**3 Position the fabric with the edge of the fabric against the guide of the presser foot, and then lower the presser foot lever.**

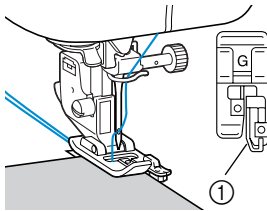

① Guide

**4 Sew with the edge of the fabric against the presser foot guide.**

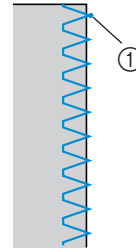



① Needle drop point

**CAUTION**

- After adjusting the stitch width, slowly turn the balance wheel toward you and check that the needle does not touch the presser foot. If the needle hits the presser foot, the needle may bend or break.

## Sewing overcasting stitches using zigzag foot “J”

Three stitches can be used to sew overcasting stitches with zigzag foot “J”.

Stitch Name	Pattern	Application	Stitch Width [mm (inch.)]		Stitch Length [mm (inch.)]		Presser Foot
			Auto	Manual	Auto	Manual	
Zigzag stitch	04 <sup>J</sup> 	Preventing fraying (center baseline/reverse stitching)	3.5 (1/8)	0.0–7.0 (0–1/4)	1.4 (1/16)	0.0–4.0 (0–3/16)	J
3-point zigzag stitch	05 <sup>J</sup> 	Preventing fraying in thick fabrics and stretch fabrics	5.0 (3/16)	1.5–7.0 (1/16–1/4)	1.0 (1/16)	0.2–4.0 (1/64–3/16)	
Overcasting stitch	08 <sup>J</sup> 	Preventing fraying in stretch fabrics	5.0 (3/16)	0.0–7.0 (0–1/4)	2.5 (3/32)	0.5–4.0 (1/32–3/16)	

### 1 Attach zigzag foot “J”.

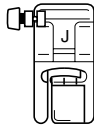

- For details, refer to “Replacing the presser foot” (page 29).

### 2 Select a stitch.

- For details, refer to “Selecting stitching” (page 54).

### 3 Sew along the edge of the fabric with the needle dropping off the edge at the right.

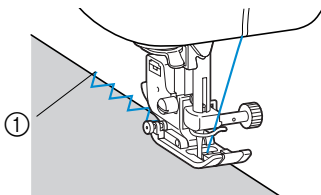

- ① Needle drop point

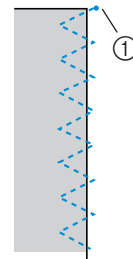

- ① Needle drop point





### Memo

- For best results when sewing stretch fabrics, decrease the pressure of the presser foot. For details, refer to “Adjusting the pressure of the presser foot” (page 30).

## Sewing overcasting stitches using the optional side cutter

Using the side cutter, seam allowances can be finished while the edge of the fabric is cut off. The following four stitches can be used to sew overcasting.

When the side cutter is attached, be sure to use the settings in the ranges listed below.

Stitch Name	Pattern	Application	Stitch Width [mm (inch.)]		Stitch Length [mm (inch.)]		Presser Foot
			Auto	Manual	Auto	Manual	
Overcasting stitch	00J 	Sewing straight stitches while cutting the fabric	0.0 (0)	0.0–2.5 (0–3/32)	2.5 (3/32)	0.2–5.0 (1/64–3/16)	S
	06G 	Preventing fraying in thin and mediumweight fabrics while cutting the fabric	3.5 (1/8)	3.5–5.0 (1/8–3/16)	2.0 (1/16)	1.0–4.0 (1/16–3/16)	
	07G 	Preventing fraying in thick fabrics while cutting the fabric	5.0 (3/16)	3.5–5.0 (1/8–3/16)	2.5 (3/32)	1.0–4.0 (1/16–3/16)	
	36J 	Sewing zigzag stitches while cutting the fabric	3.5 (1/8)	3.5–5.0 (1/8–3/16)	1.4 (1/16)	0.0–4.0 (0–3/16)	

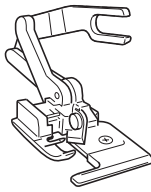

- 1 Remove the presser foot.**
  - For details, refer to “Replacing the presser foot” (page 29).
- 2 Lower the presser foot lever, and then manually thread the needle.**
  - The needle threader cannot be used. If the needle threader is used with the side cutter, the sewing machine may be damaged.
- 3 Raise the presser foot lever.**

- 4 Hook the connecting fork of the side cutter onto the needle clamp screw.**

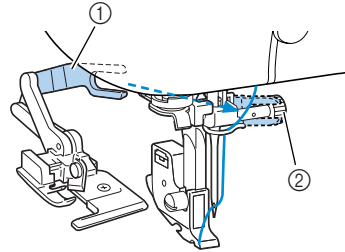

- ① Connecting fork
- ② Needle clamp screw

- 5 Position the side cutter so that side cutter pin is aligned with the notch in the presser foot holder, and then slowly lower the presser foot lever.**

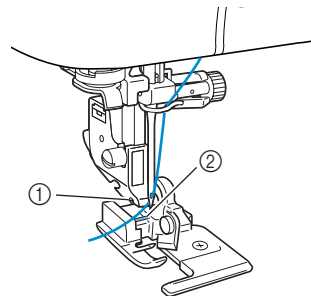

- ① Notch in presser foot holder
- ② Pin

► The side cutter is attached.



**6** Raise the presser foot lever to check that the side cutter is securely attached.

**7** Pass the upper thread under the side cutter, and then pull it out toward the rear of the sewing machine.

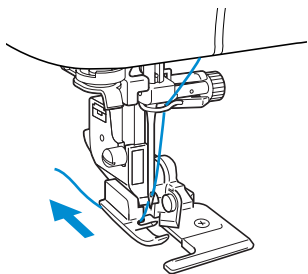

**8** Select a stitch.  
• For details, refer to “Selecting stitching” (page 54).

### **!** CAUTION

- After adjusting the stitch width, slowly turn the balance wheel toward you and check that the needle does not touch the presser foot. If the needle hits the presser foot, the needle may bend or break.

**9** Make a cut of about 2 cm (1/16 inch) long in the fabric at the beginning of the stitching.

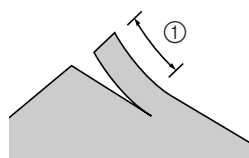

① 2 cm (1/16 inch)

**10** Position the fabric in the side cutter. The cut in the fabric should be positioned over the guide plate of the side cutter.

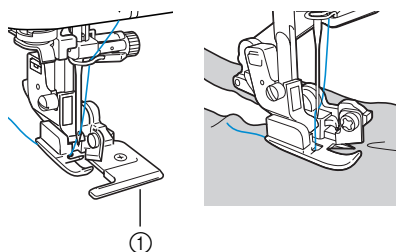

① Guide plate

- If the fabric is not positioned correctly, the fabric will not be cut.

**11** Lower the presser foot lever, and then start sewing.

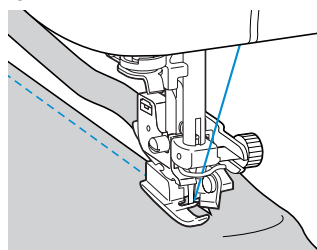

▶ A seam allowance is cut while the stitching is sewn.

- If the stitching is sewn in a straight line, the seam allowance will be about 5 mm (3/16 inch).

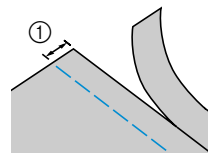

① 5 mm (3/16 inch)

### **!** Memo

- The side cutter can cut as much as one layer of 13-oz. denim.
- After using the side cutter, clean it by removing any lint or dust.
- If the side cutter can no longer cut fabric, use a rag to apply a small amount of oil to the cutting edge of the cutter.
- The optional side cutter is available through your brother retailer.

# Basic Stitching

Straight stitches are used for sewing plain seams. Three stitches are available for basic stitching.

Stitch Name	Pattern	Application	Stitch Width [mm (inch.)]		Stitch Length [mm (inch.)]		Presser Foot
			Auto	Manual	Auto	Manual	
<b>Straight stitch (left needle position)</b>	00J 	Basic stitching and sewing gathers or pintucks (left baseline/reverse stitching)	0.0 (0)	0.0–7.0 (0–1/4)	2.5 (3/32)	0.2–5.0 (1/64–3/16)	J
<b>Straight stitch (center needle position)</b>	01J 	Basic stitching and sewing gathers or pintucks (center baseline/reverse stitching)	–	–	2.5 (3/32)	0.2–5.0 (1/64–3/16)	
<b>Triple stretch stitch</b>	02J 	Reinforcing seams and sewing stretch fabrics	0.0 (0)	0.0–7.0 (0–1/4)	2.5 (3/32)	1.5–4.0 (1/16–3/16)	

## Basic stitching

- 1 Baste or pin together the fabric pieces.**
- 2 Attach zigzag foot “J”.**

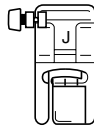

- For details, refer to “Replacing the presser foot” (page 29).

- 3 Select a stitch.**
  - For details, refer to “Selecting stitching” (page 54).

- 4 Lower the needle into the fabric at the beginning of the stitching.**

- 5 Start sewing.**
  - For details, refer to “Starting to sew” (page 39).
  - For details on sewing reverse/reinforcement stitches, refer to “Securing the stitching” (page 41).

- 6 When sewing is finished, cut the thread.**
  - For details, refer to “Cutting the thread” (page 43).



### ■ Changing the needle position

With the straight stitch (left needle position) and the triple stretch stitch, the needle position can be adjusted. Sliding the stitch width adjustment slider up moves the needle to the right; sliding the slider down moves the needle to the left.

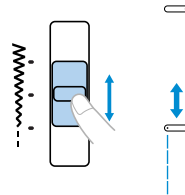

# Blind Hem Stitching

Secure the bottoms of skirts and pants with a blind hem. Two stitches are available for blind hem stitching.

Stitch Name	Pattern	Application	Stitch Width [mm (inch.)]		Stitch Length [mm (inch.)]		Presser Foot
			Auto	Manual	Auto	Manual	
Blind hem stitch	09R 	Blind hem stitching on mediumweight fabrics	0.0 (0)	+3 -- 3	2.0 (1/16)	1.0–3.5 (1/16–1/8)	R
	10R 	Blind hem stitching on stretch fabrics					

Sew a blind hem according to the following procedure.

- 1** Fold the fabric along the desired edge of the hem, and then baste it about 5 mm (3/16 inch) from the edge of the fabric.

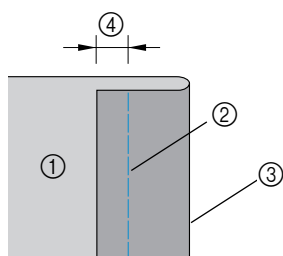

- ① Wrong side of fabric
- ② Basting stitching
- ③ Desired edge of hem
- ④ 5 mm (3/16 inch)

- 2** Fold back the fabric along the basting, and then position the fabric with the wrong side facing up.

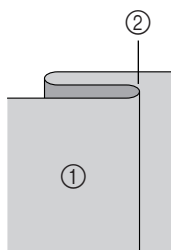

- ① Wrong side of fabric
- ② Basting

- 3** Attach blind hem foot "R".

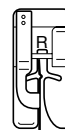

- For details, refer to "Replacing the presser foot" (page 29).

- 4** Select a stitch.

- For details, refer to "Selecting stitching" (page 54).

- 5** Position the fabric with the edge of the folded hem against the guide of the presser foot, and then lower the presser foot lever.

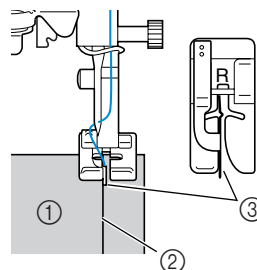

- ① Wrong side of fabric
- ② Fold of hem
- ③ Guide

**6** Adjust the stitch width until the needle slightly catches the fold of the hem.

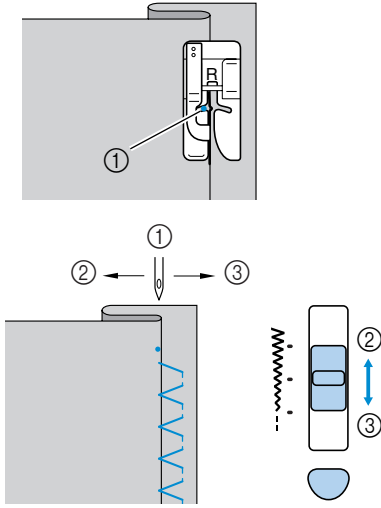

- ① Needle drop point
- ② Wider stitch
- ③ Narrower stitch

■ **If the needle catches too much of the hem fold**

If the needle catches too much of the hem fold, move the stitch width adjustment lever down. This makes the stitch narrower to move the needle away from the fold.

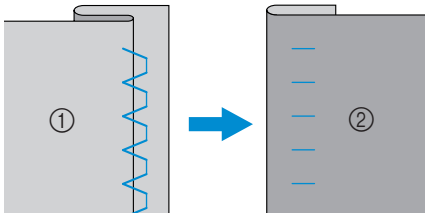

- ① Wrong side of fabric
- ② Right side of fabric

■ **If the needle does not catch the hem fold**

If the needle does not catch enough of the hem fold, move the stitch width adjustment lever up. This makes the stitch wider to move the needle closer onto the fold.

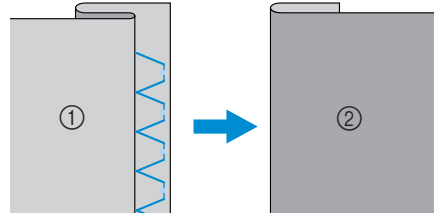

- ① Wrong side of fabric
- ② Right side of fabric

• For details on changing the stitch width, refer to “Adjusting the Stitch Width and Length” (page 45).

**7** Sew with the fold of the hem against the presser foot guide.

**8** Remove the basting stitching.

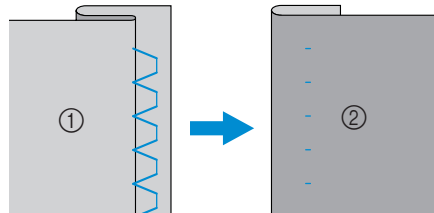







- ① Wrong side of fabric
- ② Right side of fabric

**Memo**

● For best results when sewing stretch fabrics, decrease the pressure of the presser foot. For details, refer to “Adjusting the pressure of the presser foot” (page 30).

## Buttonhole Stitching

Buttonholes can be sewn and buttons can be sewn on. Five stitches are available for sewing one-step buttonholes.

Stitch Name	Pattern	Application	Stitch Width [mm (inch.)]		Stitch Length [mm (inch.)]		Presser Foot
			Auto	Manual	Auto	Manual	
Buttonhole stitch	26A 	Horizontal buttonholes on thin and mediumweight fabrics	5.0 (3/16)	3.0–5.0 (1/8–3/16)	0.4 (1/64)	0.2–1.0 (1/64–1/16)	A
	27A 	Buttonholes with bar tacks on both ends for stabilized fabrics	5.0 (3/16)	3.0–5.0 (1/8–3/16)	0.4 (1/64)	0.2–1.0 (1/64–1/16)	
	28A 	Buttonholes for stretch or knit fabrics	6.0 (15/64)	3.0–6.0 (1/8–15/64)	1.0 (1/16)	0.5–2.0 (1/32–1/16)	
	29A 	Buttonholes for stretch fabrics	6.0 (15/64)	3.0–6.0 (1/8–15/64)	1.5 (1/16)	1.0–3.0 (1/16–1/8)	
	30A 	Keyhole buttonholes for thick or plush fabrics	7.0 (1/4)	3.0–7.0 (1/8–1/4)	0.5 (1/32)	0.3–1.0 (1/64–1/16)	
Button-sewing stitch	36J 	Button sewing	3.5 (1/8)	0.0–7.0 (0–1/4)	1.4 (1/16)	0.0–4.0 (0–3/16)	M

## Buttonhole sewing

The maximum buttonhole length is about 28 mm (1-1/8 inch) (diameter + thickness of the button). Buttonholes are sewn from the front of the presser foot to the back, as shown below.

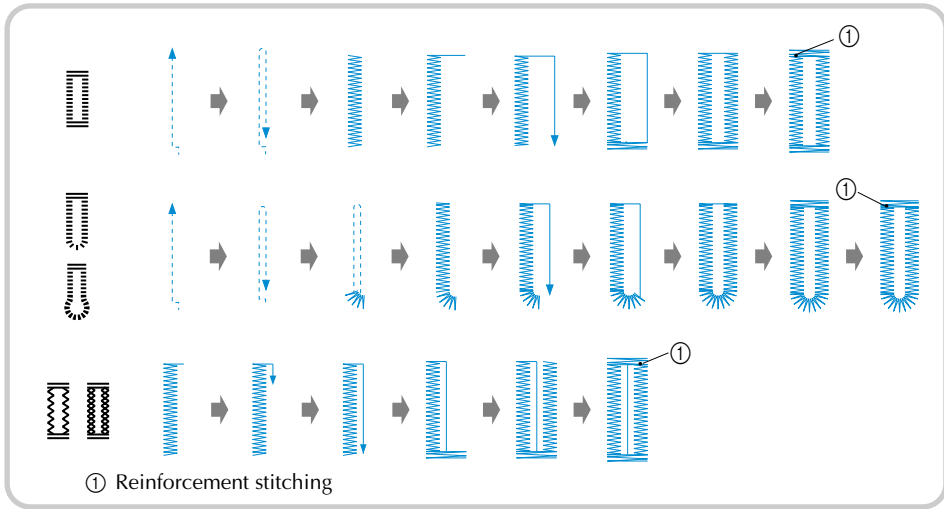

The names of parts of buttonhole foot "A", which is used for sewing buttonholes, are indicated below.

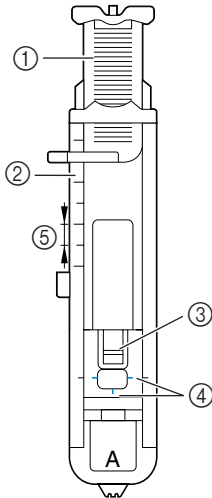

- ① Button guide plate
- ② Presser foot scale
- ③ Pin
- ④ Marks on buttonhole foot
- ⑤ 5 mm (3/16 inch)

- 1** Use chalk to mark on the fabric the position and length of the buttonhole.

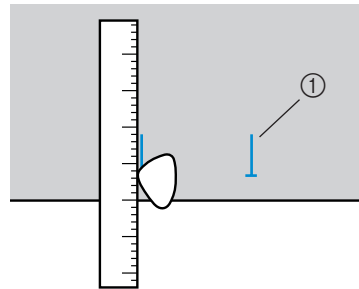

① Marks on fabric

- 2** Pull out the button guide plate of buttonhole foot "A", and then insert the button that will be put through the buttonhole.

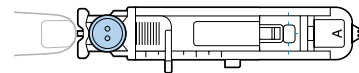

■ **If the button does not fit in the button guide plate**

Add together the diameter and thickness of the button, and then set the button guide plate to the calculated length. (The distance between the markings on the presser foot scale is 5 mm (3/16 inch).)

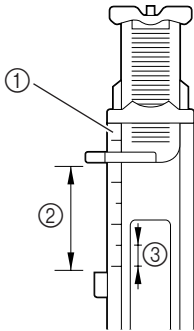

- ① Presser foot scale
- ② Length of buttonhole (Diameter + thickness of button)
- ③ 5 mm (3/16 inch)

Example: For a button with a diameter of 15 mm (9/16 inch) and a thickness of 10 mm (3/8 inch), the button guide plate should be set to 25 mm (1 inch) on the scale.

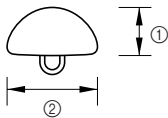

- ① 10 mm (3/8 inch)
- ② 15 mm (9/16 inch)

► The size of the buttonhole is set.

**3 Attach buttonhole foot "A".**

- For details, refer to "Replacing the presser foot" (page 29).

**4 Select a stitch.**

- For details, refer to "Selecting stitching" (page 54).

**5 Position the fabric with the front end of the buttonhole mark aligned with the red marks on the sides of the buttonhole foot, and then lower the presser foot lever.**

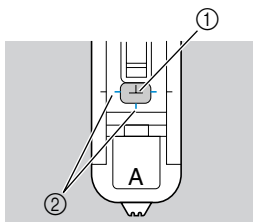

- ① Mark on fabric
- ② Red marks on buttonhole foot

Pass the upper thread down through the hole in the presser foot.

- When lowering the presser foot, do not push in the front of the presser foot, otherwise the buttonhole will not be sewn with the correct size.

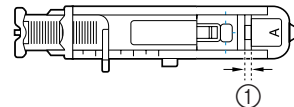
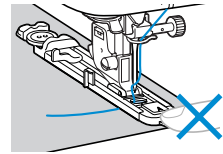

- ① Do not reduce the gap.

**6 Pull down the buttonhole lever as far as possible.**

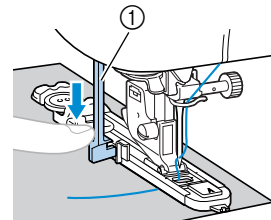

- ① Buttonhole lever

The buttonhole lever is positioned behind the bracket on the buttonhole foot.

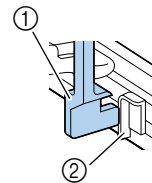

- ① Buttonhole lever
- ② Bracket

**7 Gently hold the end of the upper thread in your left hand, and then start sewing.**

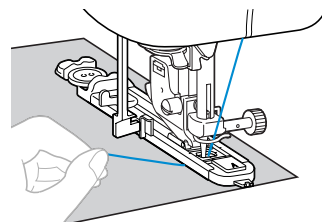

- Once sewing is completed, the machine automatically sews reinforcement stitches, then stops

**8 Raise the presser foot lever, remove the fabric, and then cut the threads.**

**9** Raise the buttonhole lever to its original position.

**10** Insert a pin along the inside of one bar tack at the end of the buttonhole stitching to prevent the stitching from being cut.

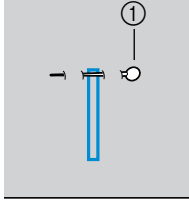

① Pin

**11** Use the seam ripper to cut towards the pin and open the buttonhole.

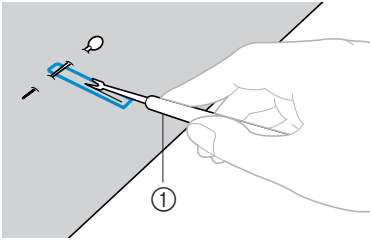

① Seam ripper

For keyhole buttonholes, use the eyelet punch to make a hole in the rounded end of the buttonhole, and then use the seam ripper to cut open the buttonhole.

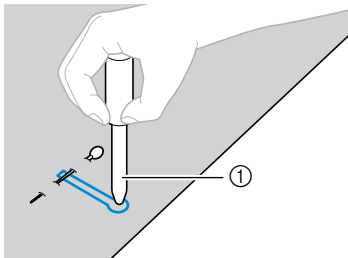

① Eyelet punch

- When using the eyelet punch, place thick paper or some other protective sheet under the fabric before punching the hole in the fabric.

**CAUTION**

- When opening the buttonhole with the seam ripper, do not place your hands in the cutting direction, otherwise injuries may result if the seam ripper slips.

**Changing the density of the stitching**

Press the stitch length adjustment button, and then slide the stitch length adjustment slider to adjust the stitch length.

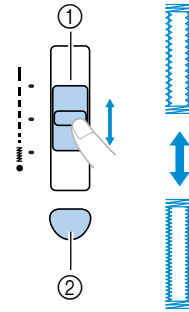

① Stitch length adjustment slider  
② Stitch length adjustment button

- For details, refer to “Adjusting the stitch length” (page 46).
- If the fabric does not feed (for example, if it is too thick), decrease the density of the stitching.

**Changing the stitch width**

Press the stitch width adjustment button, and then slide the stitch width adjustment slider to adjust the stitch width.

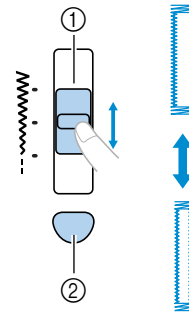

① Stitch width adjustment slider  
② Stitch width adjustment button

- For details, refer to “Adjusting the stitch width” (page 45).

**Memo**

- Before sewing buttonholes, check the stitch length and width by sewing a trial buttonhole on a scrap piece of fabric.



## ■ Sewing buttonholes on stretch fabrics

When sewing buttonholes on stretch fabrics, use a gimp thread.

- 1 Hook the gimp thread onto the part of buttonhole foot “A” shown in the illustration so that it fits into the grooves, and then loosely tie it.

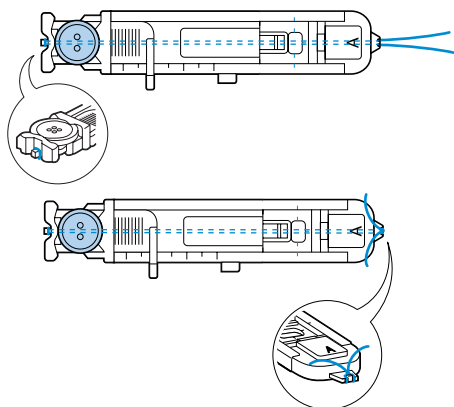

- 2 Attach buttonhole foot “A”.
  - For details, refer to “Replacing the presser foot” (page 29).

- 3 Select stitch **28A** or **29A**.

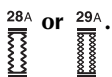

- 4 Adjust the stitch width to the thickness of the gimp thread.

- 5 Lower the presser foot lever and the buttonhole lever, and then start sewing.

- 6 When sewing is finished, gently pull the gimp thread to remove any slack.

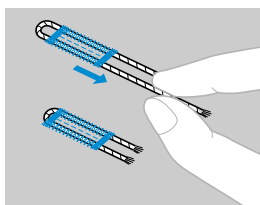

- 7 Use a handsewing needle to pull the gimp thread to the wrong side of the fabric, and then tie it.

- 8 With a seam ripper, cut the middle part of the gimp thread remaining at the top end of the buttonhole.

Trim off any excess of the gimp thread.

## Button sewing

Buttons can be sewn on with the sewing machine. Buttons with 2 or with 4 holes can be attached.

- 1 Measure the distance between the holes in the button to be attached.

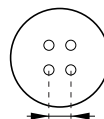

- 2 Raise the presser foot lever, and then slide the drop feed lever, located at the rear of the machine on the base, to  (to the right as seen from the front of the machine).

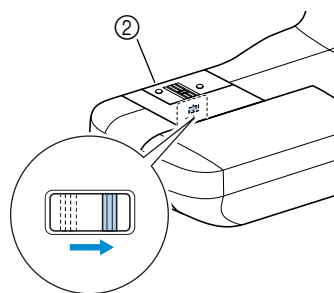
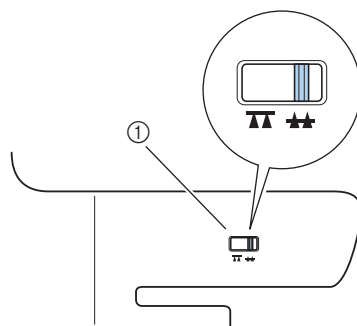

- ① Drop feed lever (as seen from the rear of the machine)
  - ② Back side
- The feed dogs are lowered.

- 3 Attach button-sewing foot “M”.

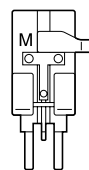

- For details, refer to “Replacing the presser foot” (page 29).

**4** Place the button into button-sewing foot “M”.

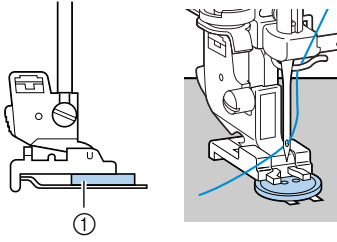

① Button

- When attaching four-hole buttons, first sew the two holes closest to you. Then, slide the button so that the needle goes into the two holes toward the rear of the sewing machine, and then sew them in the same way.

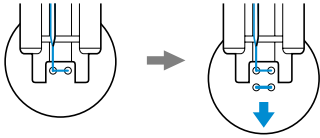

**5** Select stitch <sup>36J</sup>.

- For details, refer to “Selecting stitching” (page 54).

**6** Adjust the stitch width so that it is the same as the distance between the holes in the button.

**7** Set the stitch length adjustment slider to the shortest stitch length setting.

**8** Turn the balance wheel toward you to check that the needle correctly goes into the two holes of the button.

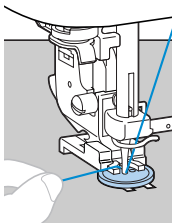
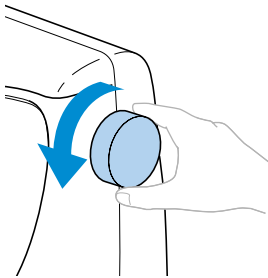

**! CAUTION**

- When sewing, be sure that the needle does not touch the button, otherwise the needle may bend or break.

**9** Start sewing.

- After sewing for about 10 seconds at low speed, press  (reverse/reinforcement stitch button) to sew reinforcement stitches.

**10** Pull the upper thread at the end of the stitching to the wrong side of the fabric, and then tie it with the bobbin thread.

Use scissors to cut the upper thread and the bobbin thread at the beginning of the stitching.

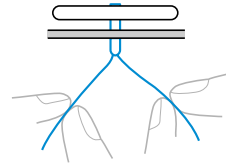

**11** When you are finished attaching the button, slide the drop feed lever to  (to the left as seen from the front of the machine) to raise the feed dogs.

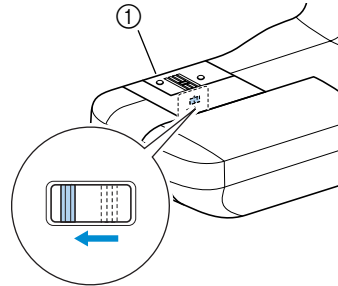

① Back side

## ■ Attaching a shank to a button

To sew the button with a shank, attach the button with space between it and the fabric, and then wind the thread by hand. This attaches the button securely.

- 1 Place the button into button-sewing foot “M”, and then pull the shank lever toward you.

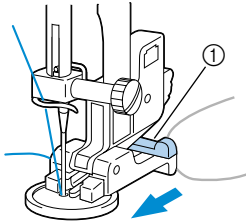

① Shank lever

- 2 After sewing is finished, cut the upper thread with plenty of excess, wind it around the thread between the button and the fabric, and then tie it to the upper thread at the beginning of the stitching.

Tie together the ends of the bobbin thread at the end and at the beginning of the stitching at the wrong side of the fabric.

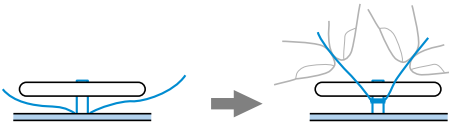

- 3 Cut off any excess thread.

# Zipper Insertion

A zipper can be sewn in place.

Stitch Name	Pattern	Application	Stitch Width [mm (inch.)]		Stitch Length [mm (inch.)]		Presser Foot
			Auto	Manual	Auto	Manual	
<b>Straight stitch (center needle position)</b>	01.J 	Attaching zippers Sewing concealed seams and pintucks	-	-	2.5 (3/32)	0.2–5.0 (1/64–3/16)	I

There are many methods for inserting zippers. The procedures for inserting a centered zipper and a side zipper are described below.

## Inserting a centered zipper

Stitching is sewn on both pieces of fabric butted against each other.

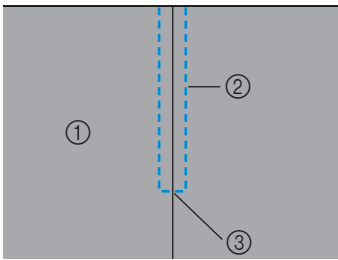

- ① Right side of fabric
- ② Stitching
- ③ End of zipper opening

### 1 Attach zigzag foot “J” and sew straight stitches up to the zipper opening.

With the right sides of the fabric facing each other, sew reverse stitches after reaching the zipper opening.

- For details, refer to “Basic Stitching” (page 60).

### 2 Using a basting stitch, continue sewing to the edge of the fabric.

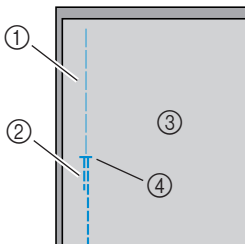

- ① Basting stitching
- ② Reverse stitches
- ③ Wrong side of fabric
- ④ End of zipper opening

### 3 Press open the seam allowance from the wrong side of the fabric.

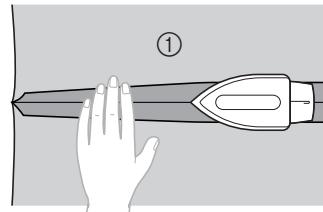

- ① Wrong side of fabric

### 4 Align the seam with the center of the zipper, and then baste the zipper in place.

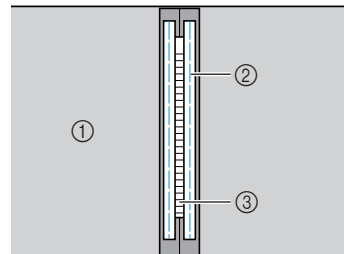

- ① Wrong side of fabric
- ② Basting stitching
- ③ Zipper

### 5 Attach the presser foot holder to the right pin of zipper foot “1”.

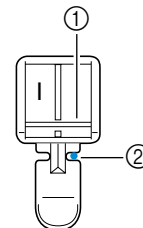

- ① Pin on the right side
- ② Needle drop point

- For details, refer to “Replacing the presser foot” (page 29).

## 6 Select stitch

- For details, refer to “Selecting stitching” (page 54).

### CAUTION

- When using zipper foot “I”, be sure to select the straight stitch (center needle position), and slowly turn the balance wheel toward you to check that the needle does not touch the presser foot. If a different stitch is selected or the needle hits the presser foot, the needle may bend or break.

## 7 Topstitch around the zipper.

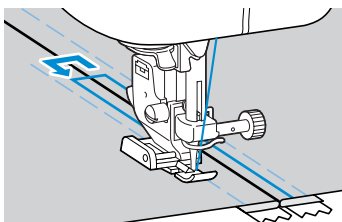
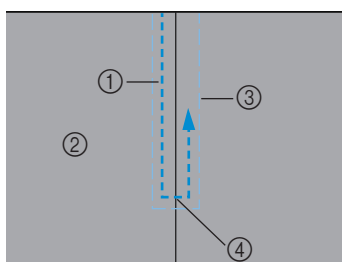

- ① Stitching
- ② Right side of fabric
- ③ Basting stitching
- ④ End of zipper opening

### CAUTION

- When sewing, be sure that the needle does not touch the zipper, otherwise the needle may bend or break.

## 8 Remove the basting stitching.

## Inserting a side zipper

Stitching is sewn on only one piece of fabric. Use this type of zipper for side openings and back openings.

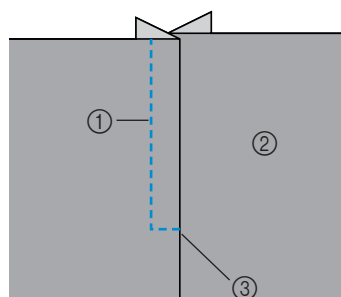

- ① Stitching
- ② Right side of fabric
- ③ End of zipper opening

The following procedure will describe how to stitch on the left side, as shown in the illustration.

### 1 Attach zigzag foot “J” and sew straight stitches up to the zipper opening.

With the right sides of the fabric facing each other, sew reverse stitches after reaching the zipper opening.

- For details, refer to “Basic Stitching” (page 60).

### 2 Using a basting stitch, continue sewing to the edge of the fabric.

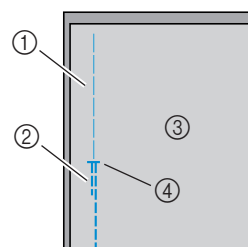

- ① Basting stitching
- ② Reverse stitches
- ③ Wrong side of fabric
- ④ End of zipper opening

### 3 Press open the seam allowance from the wrong side of the fabric.

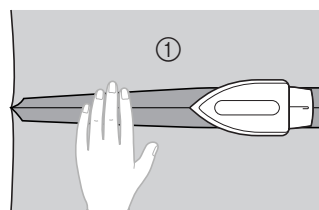

- ① Wrong side of fabric

- 4** Press the seam allowance so that the right side (the side that will not be stitched) has an extra 3 mm (1/8 inch).

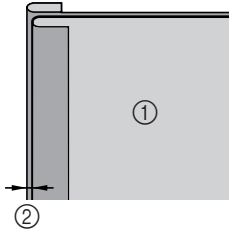

- ① Wrong side of fabric
- ② 3 mm (1/8 inch)

- 5** Align the zipper teeth with the pressed edge of the fabric having the extra 3 mm (1/8 inch), and then baste or pin the zipper in place.

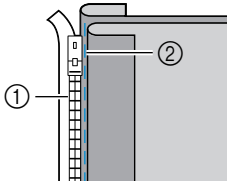

- ① Zipper teeth
- ② Basting stitching

- 6** Attach the presser foot holder to the right pin of zipper foot "I".

If the stitching will be sewn on the right side, attach the presser foot holder to the left pin of the zipper foot.

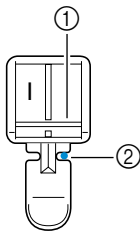

- ① Pin on the right side
- ② Needle drop point

- For details, refer to "Replacing the presser foot" (page 29).

- 7** Select stitch 

- For details, refer to "Selecting stitching" (page 54).

**! CAUTION**

- When using zipper foot "I", be sure to select the straight stitch (center needle position), and slowly turn the balance wheel toward you to check that the needle does not touch the presser foot. If a different stitch is selected or the needle hits the presser foot, the needle may bend or break.

- 8** Sew the zipper to the piece of fabric with the extra 3 mm (1/8 inch), starting from the base of the zipper.

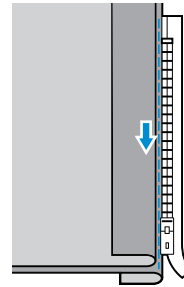

**! CAUTION**

- When sewing, be sure that the needle does not touch the zipper, otherwise the needle may bend or break.

- 9** When you are about 5 cm (2 inch) from the end of the zipper, stop the sewing machine with the needle lowered (in the fabric), raise the presser foot lever, and then open the zipper and continue sewing.

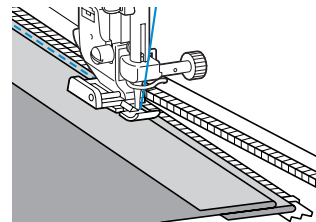

- 10** Close the zipper, turn over the fabric, and then baste the other side of the zipper to the fabric.

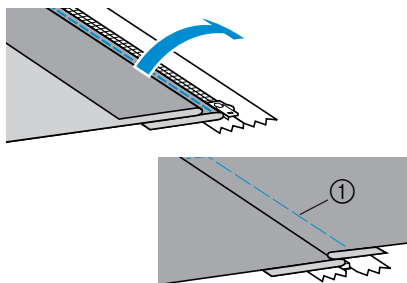

① Basting stitching

- 11** Attach the presser foot holder to the other pin of zipper foot “1”.

If the presser foot holder was attached to the right pin in step 6, change it to the left pin.

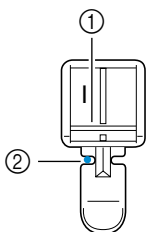

① Pin on the left side  
② Needle drop point

- 12** Topstitch around the zipper. Sew reverse stitches at the end of the zipper opening and align the zipper teeth with the side of the presser foot.

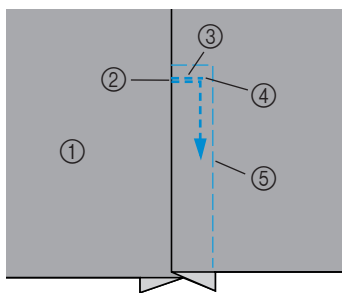

① Right side of fabric  
② End of zipper opening  
③ Reverse stitches  
④ Beginning of stitching  
⑤ Basting stitching

- 13** When you are about 5 cm (2 inch) from the end of the zipper, stop the sewing machine with the needle lowered (in the fabric), and then raise the presser foot lever.

- 14** Remove the basting stitching, open the zipper, and then continue sewing.

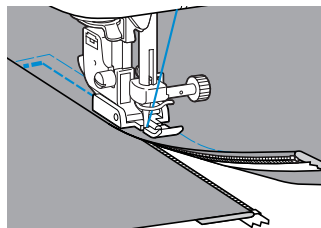

# Sewing Stretch Fabrics and Elastic Tape

Stretch fabrics can be sewn and elastic tape can be attached.

Stitch Name	Pattern	Application	Stitch Width [mm (inch.)]		Stitch Length [mm (inch.)]		Presser Foot
			Auto	Manual	Auto	Manual	
Stretch stitch	03J 	Stretch fabrics	1.0 (1/16)	1.0–3.0 (1/16–1/8)	2.5 (3/32)	1.0–4.0 (1/16–3/16)	J
3-point zigzag stitch	05J 	Attaching elastic	5.0 (3/16)	1.5–7.0 (1/16–1/4)	1.0 (1/16)	0.2–4.0 (1/64–3/16)	

Observe the corresponding precautions when performing each of the following stitching operations.

## Stretch stitching

### 1 Attach zigzag foot “J”.

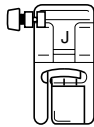

- For details, refer to “Replacing the presser foot” (page 29).

### 2 Select stitch

- For details, refer to “Selecting stitching” (page 54).

### 3 Sew the fabric without stretching it.

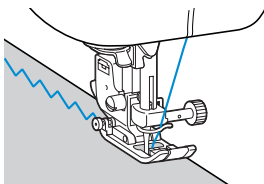

## Elastic attaching

When elastic tape is attached to the cuff or waist of a piece of clothing, the finished dimensions will be that of the stretched elastic tape. Therefore, it is necessary that a suitable length of the elastic tape be used.

### 1 Pin the elastic tape to the wrong side of the fabric.

Pin the elastic tape to the fabric at a few points to make sure that the tape is uniformly positioned on the fabric.

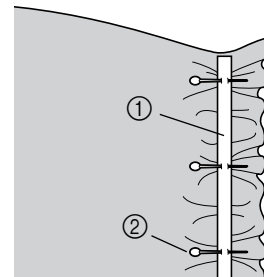

- ① Elastic tape
- ② Pin

### 2 Attach zigzag foot “J”.

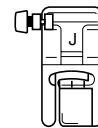

- For details, refer to “Replacing the presser foot” (page 29).



### 3 Select stitch <sup>05J</sup> .

- For details, refer to “Selecting stitching” (page 54).

### 4 Sew the elastic tape to the fabric while stretching the tape so that it is the same length as the fabric.

While pulling the fabric behind the presser foot with your left hand, pull the fabric at the pin nearest the front of the presser foot with your right hand.

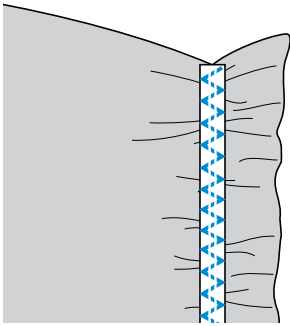
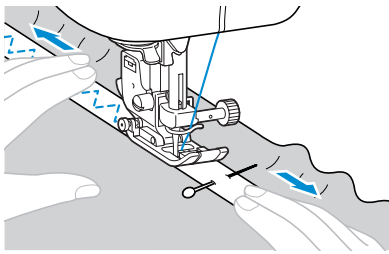













#### CAUTION

- When sewing, be sure that the needle does not touch any pins, otherwise the needle may bend or break.

## Appliqué, Patchwork and Quilt Stitching

The stitches that can be used for sewing appliqués, patchwork and quilts are described below.

Stitch Name	Pattern	Application	Stitch Width [mm (inch.)]		Stitch Length [mm (inch.)]		Presser Foot
			Auto	Manual	Auto	Manual	
Zigzag stitch	 04J	Attaching appliqués (center baseline/reverse stitching)	3.5 (1/8)	0.0–7.0 (0–1/4)	1.4 (1/16)	0.0–4.0 (0–3/16)	
	 36J	Appliqué quilting, free-motion quilting, satin stitching	3.5 (1/8)	0.0–7.0 (0–1/4)	1.4 (1/16)	0.0–4.0 (0–3/16)	
Appliqué stitch	 11J	Attaching appliqués	3.5 (1/8)	2.5–5.0 (3/32–3/16)	2.5 (3/32)	1.6–4.0 (1/16–3/16)	
	 37J	Attaching appliqués and binding	1.5 (1/16)	0.5–5.0 (1/32–3/16)	1.2 (1/16)	1.0–4.0 (1/16–3/16)	
	 38J	Attaching appliqués and binding	1.5 (1/16)	0.5–5.0 (1/32–3/16)	1.2 (1/16)	1.0–4.0 (1/16–3/16)	
Piecing straight stitch	 33J	Piecing straight stitching (with a seam allowance of 6.5 mm from the right edge of the presser foot)	5.5 (7/32)	0.0–7.0 (0–1/4)	1.6 (1/16)	0.2–5.0 (1/64–3/16)	
	 34J	Piecing straight stitching (with a seam allowance of 6.5 mm from the left edge of the presser foot)	1.5 (1/16)	0.0–7.0 (0–1/4)	1.6 (1/16)	0.2–5.0 (1/64–3/16)	
Joining stitch	 13J	Patchwork stitching	4.0 (3/16)	0.0–7.0 (0–1/4)	1.2 (1/16)	0.2–4.0 (1/64–3/16)	
	 14J		5.0 (3/16)	2.5–7.0 (3/32–1/4)	2.5 (3/32)	1.0–4.0 (1/16–3/16)	
	 15J		5.0 (3/16)	0.0–7.0 (0–1/4)	1.2 (1/16)	0.2–4.0 (1/64–3/16)	
Mock hand quilting stitch	 35J	Straight stitch quilting that looks hand quilting	0.0 (0)	0.0–7.0 (0–1/4)	2.5 (3/32)	1.0–4.0 (1/16–3/16)	
Quilting stippling	 39J	Stippling	7.0 (1/4)	1.0–7.0 (1/16–1/4)	1.6 (1/16)	1.0–4.0 (1/16–3/16)	

J

## Appliqué stitching

- 1 Cut out the appliqué, leaving a seam allowance of between 3 and 5 mm (1/8 and 3/16 inch).

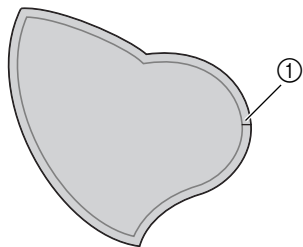

① Seam allowance

- 2 Place a pattern made of thick paper on the back of the appliqué, and then fold over the seam allowance using an iron.

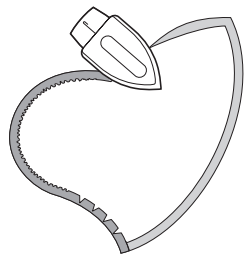

- Remove the thick paper after pressing the seam allowance.

- 3 Turn the fabric over, and then baste or pin it onto the fabric that it will be attached to.

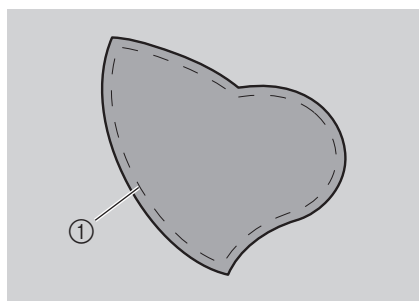

① Basting stitching

- 4 Attach zigzag foot “J”.

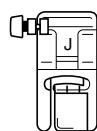

- For details, refer to “Replacing the presser foot” (page 29).

- 5 Select a stitch.
  - For details, refer to “Selecting stitching” (page 54).

- 6 Turn the balance wheel toward you, and then begin sewing around the edge of the appliqué, making sure that the needle drops just outside of the appliqué.

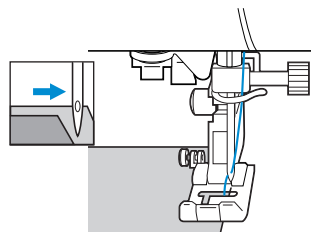

When sewing around corners, stop the machine with the needle in the fabric just outside of the appliqué, raise the presser foot lever, and then turn the fabric as needed to change the sewing direction.

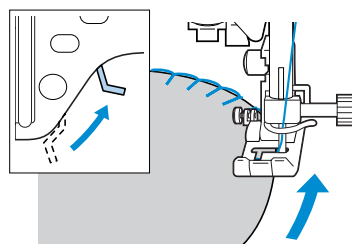

## Patchwork (crazy quilt) stitching

- 1 Fold the edge of the top piece of fabric and place it over the lower piece.
- 2 Sew the two pieces of fabric together so the pattern spans over both pieces.

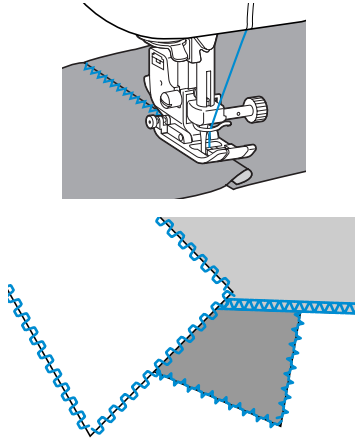

## Piecing

Sewing together two pieces of fabric is called “piecing”. The fabric pieces should be cut with a 6.5 mm (1/4 inch) seam allowance. Sew a piecing straight stitch 6.5 mm (1/4 inch) from either the right side or the left side of the presser foot.

- 1 Baste or pin along the seam allowance of the fabric that you wish to piece together.
- 2 Attach zigzag foot “J”.

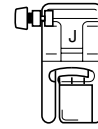

- For details, refer to “Replacing the presser foot” (page 29).

- 3 Select stitch  $\begin{matrix} 33J \\ | \\ \perp P \end{matrix}$  or  $\begin{matrix} 34J \\ | \\ \perp P \end{matrix}$ .

- For details, refer to “Selecting stitching” (page 54).

- 4 Sew with the side of the presser foot aligned with the edge of the fabric.

■ For a seam allowance on the right side

Align the right side of the presser foot with the edge of the fabric, and sew using stitch  $\begin{matrix} 33J \\ | \\ \perp P \end{matrix}$ .

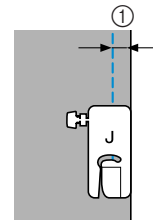

① 6.5 mm (1/4 inch)

■ For a seam allowance on the left side

Align the left side of the presser foot with the edge of the fabric, and sew using stitch  $\begin{matrix} 34J \\ | \\ \perp P \end{matrix}$ .

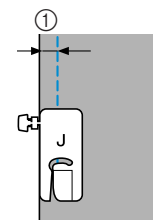

① 6.5 mm (1/4 inch)





## Memo

- To change the width of the seam allowance (the needle position), adjust the stitch width.

## Quilting

Sandwiching batting between the top and bottom layers of fabric is called “quilting”. Quilts can easily be sewn using the optional walking foot and the optional quilting guide.

- 1 Baste the fabric to be quilted.**
- 2 Attach the walking foot.**
  - For details, refer to “Using the optional walking foot” (page 31).
- 3 Select stitch**  or  .
  - For details, refer to “Selecting stitching” (page 54).
- 4 Place one hand on each side of the presser foot, and then evenly stretch the fabric while sewing.**

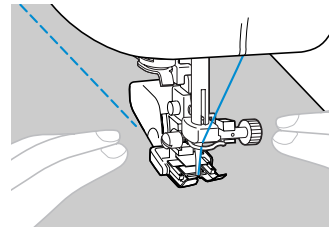

## Note

- When sewing with the walking foot, sew at a speed between slow and medium.
- The optional walking foot is available through your brother retailer.

■ **Using the optional quilting guide**

Use the quilting guide to sew parallel stitches that are equally spaced.

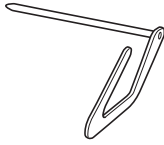

- 1 **Insert the stem of the quilting guide into the hole at the rear of the walking foot or presser foot holder.**

Walking foot

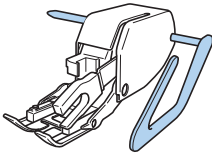

Presser foot holder

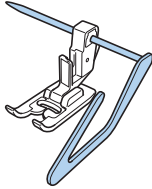

- 2 **Adjust the stem of the quilting guide so that the quilt guide aligns with the seam that has already been sewn.**

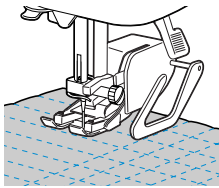

**Note**

- The optional quilting guide is available through your brother retailer.

**Free-motion quilting**

With free-motion quilting, the feed dogs can be lowered (using the drop feed lever) so that the fabric can be moved freely in any direction. The optional quilting foot is needed for free-motion quilting.

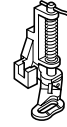

- 1 **Remove the presser foot and the presser foot holder.**

- Refer to “Removing the presser foot holder” (page 31).

- 2 **Align the quilting foot with the lower-left side of the presser bar.**

The pin on the quilting foot should be positioned over the needle clamp screw.

- 3 **Hold the quilting foot in place with your right hand, and then tighten the presser foot holder screw using the screwdriver in your left hand.**

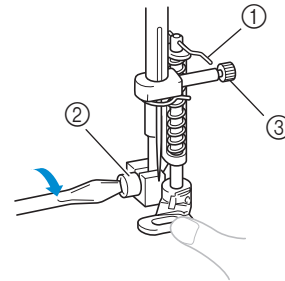

- ① Pin on quilting foot
- ② Presser foot holder screw
- ③ Needle clamp screw

**CAUTION**

- **Be sure to securely tighten the screws with the screwdriver, otherwise the needle may touch the presser foot, causing it to bend or break.**

- 4** Slide the drop feed lever, located at the rear of the machine on the base, to  (to the right as seen from the front of the machine).

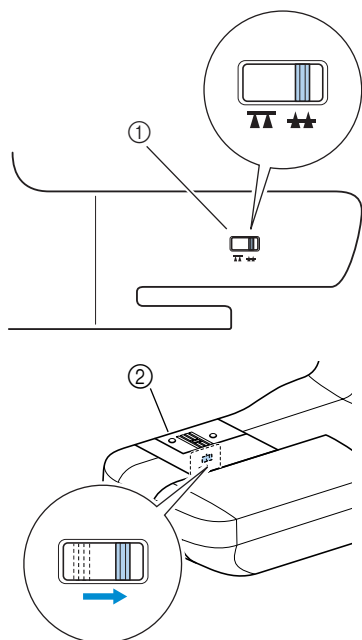

- ① Feed dog position switch  
(as seen from the rear of the machine)
- ② Back side
- The feed dogs are lowered.

- 5** Turn on the sewing machine, and then select a stitch.

- For details, refer to “Selecting stitching” (page 54).

- 6** Use both hands to stretch the fabric taut, and then move the fabric to follow the pattern. Reinforcement stitches are sewn at the beginning and end of sewing.

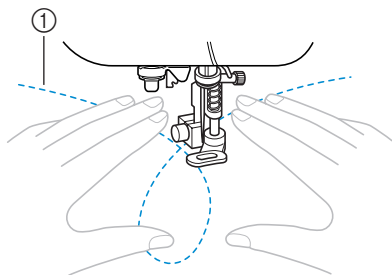

- ① Pattern

- 7** After sewing is finished, slide the drop feed lever to  (to the left as seen from the front of the machine) to raise the feed dogs.

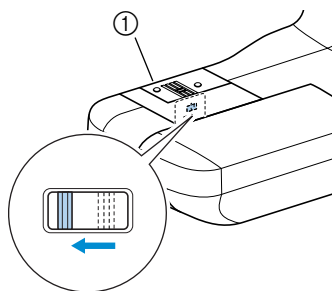

- ① Back side
- Normally, the drop feed lever is positioned at the left.





### Note

- The optional quilting foot is available through your brother retailer.

# Reinforcement Stitching

Reinforce points that will be subject to strain, such as sleeve holes, inseams and pocket corners.

Stitch Name	Pattern	Application	Stitch Width [mm (inch.)]		Stitch Length [mm (inch.)]		Presser Foot
			Auto	Manual	Auto	Manual	
<b>Triple stretch stitch</b>	02J 	Reinforcing the seams of sleeves and inseams	0.0 (0)	0.0–7.0 (0–1/4)	2.5 (3/32)	1.5–4.0 (1/16–3/16)	J
<b>Bar tack stitch</b>	31A 	Reinforcing the ends of openings, such as the corners of pockets	2.0 (1/16)	1.0–3.0 (1/16–1/8)	0.4 (1/64)	0.3–1.0 (1/64–1/16)	A

## Triple stretch stitching

Use triple stretch stitching to reinforce sleeve holes and inseams.

### 1 Attach zigzag foot “J”.

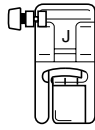

- For details, refer to “Replacing the presser foot” (page 29).

### 2 Select stitch

- For details, refer to “Selecting stitching” (page 54).

### 3 Start sewing.

- For details, refer to “Starting to sew” (page 39).

## Bar tack stitching

Bar tacks are used to reinforce points subject to strain, such as pocket corners and openings. As an example, the procedure for sewing bar tacks at pocket corners is described below.

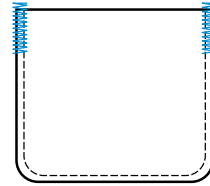

### 1 Determine the desired length of the bar tack.

Set the button guide plate on buttonhole foot “A” to the desired length. (The distance between the markings on the presser foot scale is 5 mm (3/16 inch).)

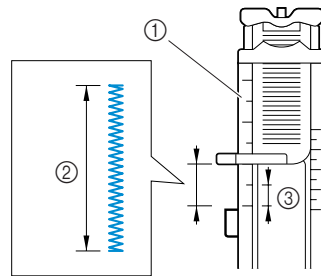

- ① Presser foot scale
- ② Length of bar tack
- ③ 5 mm (1/8 inch)

- A bar tack with a maximum length of about 28 mm (1–1/8 inch) can be sewn.



- 2 Attach buttonhole foot “A”.**
- For details, refer to “Replacing the presser foot” (page 29).

- 3 Select stitch 31A.**
- For details, refer to “Selecting stitching” (page 54).

- 4 Position the fabric so that the opening of the pocket faces toward you, and then lower the presser foot lever so that the needle drops 2 mm (1/16 inch) in front of the pocket opening.**

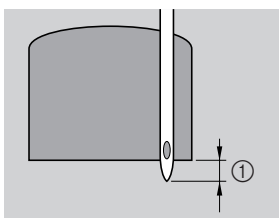

① 2 mm (1/16 inch)

Pass the upper thread down through the hole in the presser foot.

- When lowering the presser foot, do not push in the front of the presser foot, otherwise the bar tack will not be sewn with the correct size.

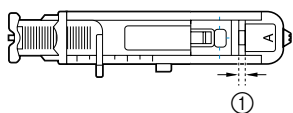
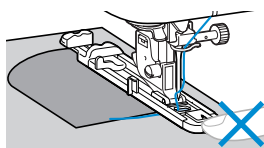

① Do not reduce the gap.

- 5 Pull down the buttonhole lever as far as possible.**

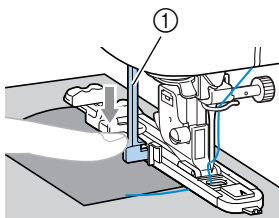

① Buttonhole lever

The buttonhole lever is positioned behind the bracket on the buttonhole foot.

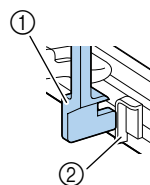

① Buttonhole lever  
② Bracket

- 6 Gently hold the end of the upper thread in your left hand, and then start sewing.**

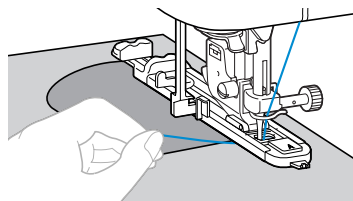

- ▶ Once sewing is completed, the machine automatically sews reinforcement stitches, then stops

- 7 Raise the presser foot lever, remove the fabric, and cut the threads.**

- 8 Raise the buttonhole lever to its original position.**

### Memo

- If the fabric does not feed, for example, because it is too thick, increase the stitch length. For details, refer to “Adjusting the stitch length” (page 46).

# Eyelet Stitching

Eyelets, such as those on belts, can be sewn. Three sizes of eyelets are possible: 7 mm, 6 mm and 5 mm (1/4, 15/64 and 3/16 inch).

Stitch Name	Pattern	Application	Stitch Width [mm (inch.)]		Stitch Length [mm (inch.)]		Presser Foot
			Auto	Manual	Auto	Manual	
Eyelet stitch	<sup>32N</sup> 	Sewing eyelets, for example, on belts	7.0 (1/4)	7.0, 6.0 or 5.0 (1/4, 15/64 or 3/16)	-	-	N

**1** Attach monogramming foot “N”.

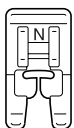

- For details, refer to “Replacing the presser foot” (page 29).

**2** Select stitch <sup>32N</sup> .

- For details, refer to “Selecting stitching” (page 54).

**3** Adjust the stitch width to select the desired eyelet size.



- For details, refer to “Adjusting the Stitch Width and Length” (page 45).

**4** Lower the needle into the fabric at the beginning of the stitching, and then lower the presser foot lever.

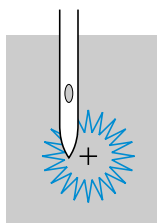

**5** Start sewing.

- ▶ Once sewing is completed, the machine automatically sews reinforcement stitches, then stops.

**6** Use the eyelet punch to cut a hole in the center of the eyelet.

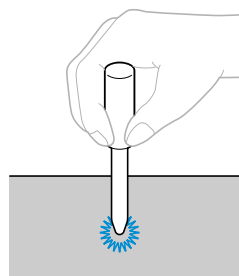

















- When using the eyelet punch, place thick paper or some other protective sheet under the fabric before punching the hole in the fabric.

 **Memo**

- If thin thread is used, the stitching may be coarse. If this occurs, sew the eyelet twice before removing the fabric, one on top of the other.

# Decorative Stitching

Various decorative stitches can be sewn with this sewing machine.

Stitch Name	Pattern	Application	Stitch Width [mm (inch.)]		Stitch Length [mm (inch.)]		Presser Foot	
			Auto	Manual	Auto	Manual		
Fagoting stitch	16J 	Sewing two pieces of fabric together across an open seam	5.0 (3/16)	0.0–7.0 (0–1/4)	2.5 (3/32)	1.0–4.0 (1/16–3/16)	J	
	17J 		5.0 (3/16)	2.5–7.0 (3/25–1/4)	2.5 (3/32)	1.0–4.0 (1/16–3/16)		
Joining stitch	13J 	Decorative bridging stitches	4.0 (3/16)	0.0–7.0 (0–1/4)	1.2 (1/16)	0.2–4.0 (1/64–3/16)		
	14J 		5.0 (3/16)	2.5–7.0 (3/32–1/4)	2.5 (3/32)	1.0–4.0 (1/16–3/16)		
	15J 		5.0 (3/16)	0.0–7.0 (0–1/4)	1.2 (1/16)	0.2–4.0 (1/64–3/16)		
Smocking stitch	16J 	Smocking fabrics to add texture and elasticity	5.0 (3/16)	0.0–7.0 (0–1/4)	2.5 (3/32)	1.0–4.0 (1/16–3/16)		
	17J 		5.0 (3/16)	2.5–7.0 (3/32–1/4)	2.5 (3/32)	1.0–4.0 (1/16–3/16)		
Scallop stitch	12N 	Satin scallop stitching	5.0 (3/16)	2.5–7.0 (3/32–1/4)	0.5 (1/32)	0.1–1.0 (1/64–1/16)		N
Decorative stitch	21N 	Lace sewing, decorative hemming, heirloom stitching, etc.	3.5 (1/8)	1.5–7.0 (1/16–1/4)	2.5 (3/32)	1.6–4.0 (1/16–3/16)		
	22N 		6.0 (15/64)	1.5–7.0 (1/16–1/4)	3.0 (1/8)	1.5–4.0 (1/16–3/16)		
	23N 	Decorative hemming and heirloom stitching, etc. on thin, mediumweight and plain weave fabrics	5.0 (3/16)	1.5–7.0 (1/16–1/4)	3.5 (1/8)	1.5–4.0 (1/16–3/16)		
	24N 		5.0 (3/16)	1.5–7.0 (1/16–1/4)	4.0 (3/16)	1.5–4.0 (1/16–3/16)		
	25N 		5.0 (3/16)	1.5–7.0 (1/16–1/4)	2.5 (3/32)	1.5–4.0 (1/16–3/16)		
Decorative stitch	18J 	Decorative stitching	4.0 (3/16)	0.0–7.0 (0–1/4)	3.0 (1/8)	2.0–4.0 (1/16–3/16)	J	
	19J 		4.0 (3/16)	0.0–7.0 (0–1/4)	2.5 (3/32)	1.0–4.0 (1/16–3/16)	N	
	20N 		5.0 (3/16)	1.5–7.0 (1/16–1/4)	1.0 (1/16)	0.2–4.0 (1/64–3/16)		

## Fagoting

Stitching across an open seam is called “fagoting”. It is used on blouses and children’s clothing. This stitch is more decorative when thicker thread is used.

- 1 Use an iron to fold the two pieces of fabric along their seams.
- 2 Baste the two pieces of fabric, separated by about 4 mm (3/16 inch), onto thin paper or a sheet of water-soluble stabilizer.

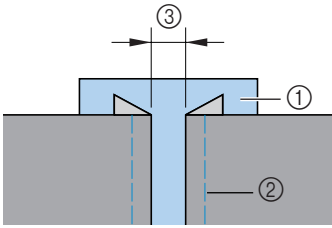

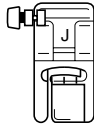

- ① Thin paper or water soluble stabilizer
- ② Basting stitching
- ③ 4 mm (3/16 inch)

- 3 Attach zigzag foot “J”.



- For details, refer to “Replacing the presser foot” (page 29).

- 4 Select stitch  or .

- For details, refer to “Selecting stitching” (page 54).

- 5 Set the stitch width to 7.0 mm (1/4 inch).
- For details, refer to “Adjusting the stitch width” (page 45).

- 6 Sew with the center of the presser foot aligned along the center of the two pieces of fabric.

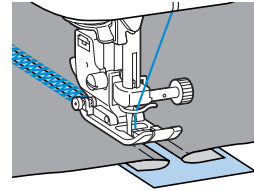
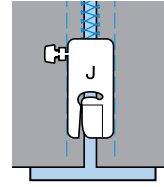

- 7 After sewing is finished, remove the paper.

## Scallop stitching

The wave-shaped repeating pattern that looks like shells is called “scalloping”. It is used on the collars of blouses and to decorate the edges of handkerchiefs.

### 1 Attach monogramming foot “N”.

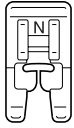

- For details, refer to “Replacing the presser foot” (page 29).

### 2 Select stitch

- For details, refer to “Selecting stitching” (page 54).

### 3 Stitch along the edge of the fabric, making sure not to sew directly on the edge of the fabric.

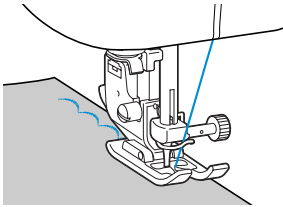

- For better results, apply spray starch onto the fabric and press with a hot iron before it is sewn.

### 4 Trim along the stitches.

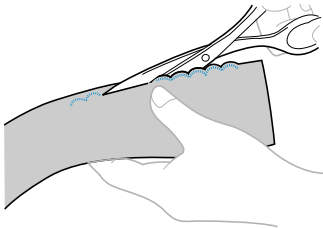

- Be careful not to cut the stitches.

## Smocking

The decorative stitch created by stitching or embroidering over gathers is called “smocking”. It is used to decorate the front of blouses or cuffs. The smocking stitch adds texture and elasticity to fabric.

### 1 Attach zigzag foot “J”.

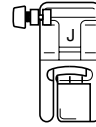

- For details, refer to “Replacing the presser foot” (page 29).

### 2 Select the straight stitch, and then adjust the stitch length to 4.0 mm (3/16 inch) and loosen the thread tension.

- For details, refer to “Adjusting the stitch length” (page 46) and “Changing the tension of the upper thread” (page 44).

### 3 Sew parallel stitching at intervals of 1 cm (3/8 inch).

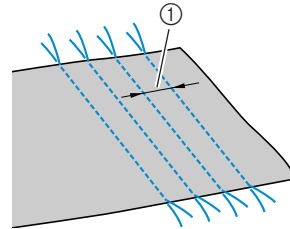

① 1 cm (3/8 inch)

- It is not necessary to sew reverse/reinforcement stitches.

### 4 Pull the bobbin threads to create gathers. Smooth the gathers by ironing them.

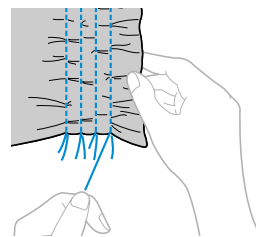

- 5** Select stitch  or .

- For details, refer to “Selecting stitching” (page 54).

- 6** Stitch between the straight stitches.

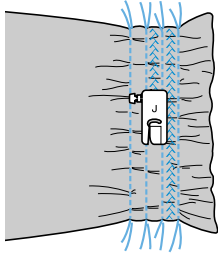

- 7** Pull out the threads for the straight stitches.

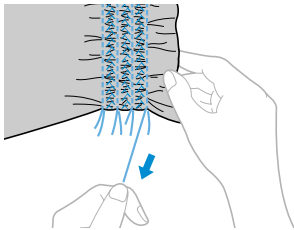

## Joining

Decorative bridging stitches can be sewn over the seam allowance of joined fabrics. This is used when making a crazy quilt.

- 1** Attach zigzag foot “J”.

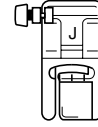

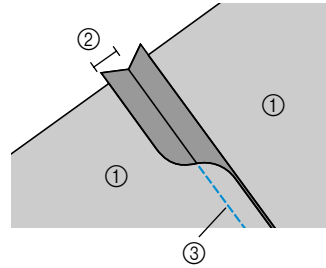

- For details, refer to “Replacing the presser foot” (page 29).

- 2** Sew together the right sides of the two pieces of fabric, and then open up the seam allowances.



- ① Wrong side of fabric
- ② 6.5 mm (1/4 inch) seam allowance
- ③ Straight stitch

- 3** Select stitch ,  or .

- For details, refer to “Selecting stitching” (page 54).

- 4** Turn the fabric over so that the right side faces up, and then sew over the seam with the center of the presser foot aligned with the seam.

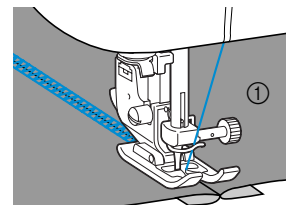

- ① Right side of fabric

## Heirloom stitching

When sewing with the wing needle, the needle holes are enlarged, creating a lace-like decorative stitch. This is used to decorate hems and tablecloths on thin or mediumweight fabrics in addition to plain weave fabrics.

### 1 Install the wing needle.

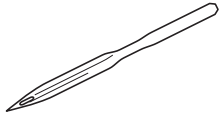

- Use a 130/705H 100/16 wing needle.
- For details on installing a needle, refer to “Replacing the needle” (page 28).
- The needle threader cannot be used with the wing needle, otherwise the sewing machine may be damaged. Manually pass the thread through the eye of the needle from the front to the back.

### 2 Attach monogramming foot “N”.

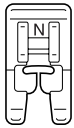

- For details, refer to “Replacing the presser foot” (page 29).

### 3 Select a stitch.

The stitches that can be used are  ,



- For details, refer to “Selecting stitching” (page 54).
- Select a stitch width of 6.0 mm (15/64 inch) or less.

### 4 Start sewing.

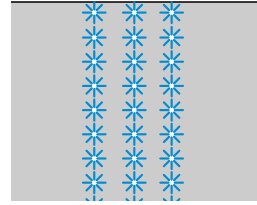

### ! CAUTION

- Select a stitch width of 6.0 mm (15/64 inch) or less, otherwise the needle may bend or break.
- After adjusting the stitch width, slowly turn the balance wheel toward you and check that the needle does not touch the presser foot. If the needle hits the presser foot, the needle may bend or break.

Partially removing threads is called “drawnwork”. This gives a beautiful result with fabrics that have a loose weave.

Two ways to create drawnwork are described below.

#### ■ Drawnwork (Example 1)

The fabric is turned and sewn twice.

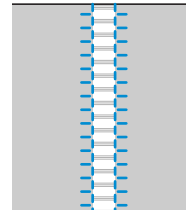

### 1 Pull out several threads from the fabric.

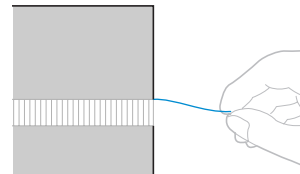

### 2 Attach monogramming foot “N”.

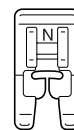

- For details, refer to “Replacing the presser foot” (page 29).

③ Select stitch <sup>21N</sup> .

- For details, refer to “Selecting stitching” (page 54).

④ With the right side of the fabric facing up, sew along the right edge of the frayed section.

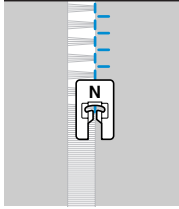

⑤ Turn the fabric around to sew the opposite side.

⑥ Sew along the other edge of the frayed section so that it looks like the previous stitching.

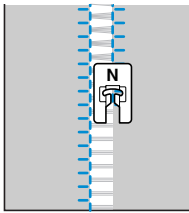

■ Drawnwork (Example 2)

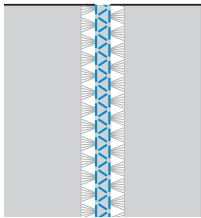

① Pull out several threads from two sections of the fabric, separated by an unfrayed section of about 4 mm (3/16 inch).

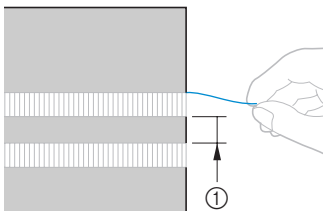

① 4 mm (3/16 inch)

② Attach monogramming foot “N”.

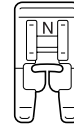

- For details, refer to “Replacing the presser foot” (page 29).

③ Select stitch <sup>24N</sup> .

- For details, refer to “Selecting stitching” (page 54).

④ Sew along the center of the unfrayed section.

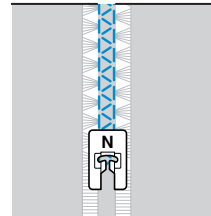



# 4

## APPENDIX













The various maintenance and troubleshooting procedures are described in this chapter.













Stitch Settings.....	92
Maintenance .....	96
Troubleshooting .....	98
Index .....	103

















## Stitch Settings









Applications, stitch lengths and widths and whether the twin needle can be used are listed for utility stitches in the following table.

### Utility stitches

Stitch Name	Pattern	Presser Foot	Application	Stitch Width [mm (inch.)]		Stitch Length [mm (inch.)]		Twin Needle	Reverse/Reinforcement Stitching	Walking Foot	Side cutter	
				Auto	Manual	Auto	Manual					
Straight stitch	Left	00J 	J	Basic stitching, sewing gathers or pintucks, etc.	0.0 (0)	0.0–7.0 (0–1/4)	2.5 (3/32)	0.2–5.0 (1/64–3/16)	No	Reverse	No	Yes
	Center	01J 	J/I	Attaching zippers, basic stitching, sewing gathers or pintucks, etc.	–	–	2.5 (3/32)	0.2–5.0 (1/64–3/16)	Yes	Reverse	No	No
Triple stretch stitch	02J 	J	Attaching sleeves, sewing inseams, sewing stretch fabrics and decorative stitching	0.0 (0)	0.0–7.0 (0–1/4)	2.5 (3/32)	1.5–4.0 (1/16–3/16)	No	Reinforcement	No	No	
Stretch stitch	03J 	J	Sewing stretch fabrics and decorative stitching	1.0 (1/16)	1.0–3.0 (1/16–1/8)	2.5 (3/32)	1.0–4.0 (1/16–3/16)	Yes	Reinforcement	No	No	
Zigzag stitch	04J 	J	Overcasting and attaching appliques	3.5 (1/8)	0.0–7.0 (0–1/4)	1.4 (1/16)	0.0–4.0 (0–3/16)	Yes	Reverse	No	No	
3-point zigzag stitch	05J 	J	Overcasting on mediumweight or stretch fabrics, attaching elastic, darning, etc.	5.0 (3/16)	1.5–7.0 (1/16–1/4)	1.0 (1/16)	0.2–4.0 (1/64–3/16)	Yes	Reinforcement	No	No	
Overcasting stitch	06G 	G	Overcasting on thin or mediumweight fabrics	3.5 (1/8)	2.5–5.0 (3/32–3/16)	2.0 (1/16)	1.0–4.0 (1/16–3/16)	No	Reinforcement	No	Yes	
	07G 	G	Overcasting on thick fabrics	5.0 (3/16)	2.5–5.0 (3/32–3/16)	2.5 (3/32)	1.0–4.0 (1/16–3/16)	No	Reinforcement	No	Yes	
	08J 	J	Overcasting on stretch fabrics	5.0 (3/16)	0.0–7.0 (0–1/4)	2.5 (3/32)	0.5–4.0 (1/32–3/16)	Yes	Reinforcement	No	No	
Blind hem stitch	09R 	R	Blind hem stitching on mediumweight fabrics	0.0 (0)	+3– –3	2.0 (1/16)	1.0–3.5 (1/16–1/8)	No	Reinforcement	No	No	
	10R 	R	Blind hem stitching on stretch fabrics	0.0 (0)	+3– –3	2.0 (1/16)	1.0–3.5 (1/16–1/8)	No	Reinforcement	No	No	
Appliqué stitch	11J 	J	Appliqué stitching	3.5 (1/8)	2.5–5.0 (3/32–3/16)	2.5 (3/32)	1.6–4.0 (1/16–3/16)	Yes	Reinforcement	No	No	
Satin scallop stitch	12N 	N	Scallop stitching	5.0 (3/16)	2.5–7.0 (3/32–1/4)	0.5 (1/32)	0.1–1.0 (1/64–1/16)	Yes	Reinforcement	No	No	

Stitch Name	Pattern	Presser Foot	Application	Stitch Width [mm (inch.)]		Stitch Length [mm (inch.)]		Twin Needle	Reverse/Reinforcement Stitching	Walking Foot	Side cutter
				Auto	Manual	Auto	Manual				
Joining stitch	 13J	J	Patchwork stitching and decorative stitching	4.0 (3/16)	0.0–7.0 (0–1/4)	1.2 (1/16)	0.2–4.0 (1/64–3/16)	Yes	Reinforcement	No	No
	 14J	J	Patchwork stitching, decorative stitching and sewing overcasting on both pieces of fabric, such as with tricot	5.0 (3/16)	2.5–7.0 (3/32–1/4)	2.5 (3/32)	1.0–4.0 (1/16–3/16)	Yes	Reinforcement	No	No
	 15J	J	Patchwork stitching and decorative stitching	5.0 (3/16)	0.0–7.0 (0–1/4)	1.2 (1/16)	0.2–4.0 (1/64–3/16)	Yes	Reinforcement	No	No
Fagoting stitch	 16J	J	Fagoting and decorative stitching	5.0 (3/16)	0.0–7.0 (0–1/4)	2.5 (3/32)	1.0–4.0 (1/16–3/16)	Yes	Reinforcement	No	No
	 17J	J	Fagoting and decorative stitching	5.0 (3/16)	2.5–7.0 (3/32–1/4)	2.5 (3/32)	1.0–4.0 (1/16–3/16)	Yes	Reinforcement	No	No
Decorative stitch	 18J	J	Decorative stitching	4.0 (3/16)	0.0–7.0 (0–1/4)	3.0 (1/8)	2.0–4.0 (1/16–3/16)	No	Reinforcement	No	No
	 19J	J	Decorative stitching	4.0 (3/16)	0.0–7.0 (0–1/4)	2.5 (3/32)	1.0–4.0 (1/16–3/16)	Yes	Reinforcement	No	No
	 20N	N	Decorative stitching and elastic-attaching	5.0 (3/16)	1.5–7.0 (1/16–1/4)	1.0 (1/16)	0.2–4.0 (1/64–3/16)	Yes	Reinforcement	No	No
	 21N	N	Lace sewing, decorative hemming, heirloom stitching, etc.	3.5 (1/8)	1.5–7.0 (1/16–1/4)	2.5 (3/32)	1.6–4.0 (1/16–3/16)	No	Reinforcement	No	No
	 22N	N	Decorative hemming, heirloom stitching, etc.	6.0 (15/64)	1.5–7.0 (1/16–1/4)	3.0 (1/8)	1.5–4.0 (1/16–3/16)	No	Reinforcement	No	No
	 23N	N	Decorative hemming on thin, mediumweight and plain weave fabrics, heirloom stitching, etc.	5.0 (3/16)	1.5–7.0 (1/16–1/4)	3.5 (1/8)	1.5–4.0 (1/16–3/16)	No	Reinforcement	No	No
	 24N	N	Decorative hemming on thin, mediumweight and plain weave fabrics, heirloom stitching, etc.	5.0 (3/16)	1.5–7.0 (1/16–1/4)	4.0 (3/16)	1.5–4.0 (1/16–3/16)	Yes	Reinforcement	No	No
	 25N	N	Decorative hemming on thin, mediumweight and plain weave fabrics, heirloom stitching, etc.	5.0 (3/16)	1.5–7.0 (1/16–1/4)	2.5 (3/32)	1.5–4.0 (1/16–3/16)	Yes	Reinforcement	No	No

Stitch Name	Pattern	Presser Foot	Application	Stitch Width [mm (inch.)]		Stitch Length [mm (inch.)]		Twin Needle	Reverse/Reinforcement Stitching	Walking Foot	Side cutter
				Auto	Manual	Auto	Manual				
Buttonhole stitch		A	Horizontal buttonholes on thin and medium-weight fabrics	5.0 (3/16)	3.0–5.0 (1/8–3/16)	0.4 (1/64)	0.2–1.0 (1/64–1/16)	No	Automatic reinforcement	No	No
		A	Secured buttonholes for fabrics that have backings	5.0 (3/16)	3.0–5.0 (1/8–3/16)	0.4 (1/64)	0.2–1.0 (1/64–1/16)	No	Automatic reinforcement	No	No
		A	Buttonholes for stretch or knit fabrics	6.0 (15/54)	3.0–6.0 (1/8–15/64)	1.0 (1/16)	0.5–2.0 (1/32–1/16)	No	Automatic reinforcement	No	No
		A	Buttonholes for stretch fabrics	6.0 (15/54)	3.0–6.0 (1/8–15/64)	1.5 (1/16)	1.0–3.0 (1/16–1/8)	No	Automatic reinforcement	No	No
		A	Keyhole buttonholes for thick or furry fabrics	7.0 (1/4)	3.0–7.0 (1/8–1/4)	0.5 (1/32)	0.3–1.0 (1/64–1/16)	No	Automatic reinforcement	No	No
Bar tack stitch		A	Reinforcing openings and areas where the seam easily comes loose	2.0 (1/16)	1.0–3.0 (1/16–1/8)	0.4 (1/64)	0.3–1.0 (1/64–1/16)	No	Automatic reinforcement	No	No
Eyelet stitch		N	Sewing eyelets, for example, on belts	7.0 (1/4)	7.0, 6.0, 5.0 (1/4, 15/64, 3/16)	–	–	No	Automatic reinforcement	No	No
Piecing straight stitch		J	Piecing straight stitching (with a seam allowance of 6.5 mm from the right edge of the presser foot)	5.5 (7/32)	0.0–7.0 (0–1/4)	1.6 (1/16)	0.2–5.0 (1/64–3/16)	No	Reinforcement	No	No
		J	Piecing straight stitching (with a seam allowance of 6.5 mm from the left edge of the presser foot)	1.5 (1/16)	0.0–7.0 (0–1/4)	1.6 (1/16)	0.2–5.0 (1/64–3/16)	No	Reinforcement	Yes	No
Straight stitch that looks hand-sewn (for quilting)		J	Straight stitch quilting that looks hand-sewn	0.0 (0)	0.0–7.0 (0–1/4)	2.5 (3/32)	1.0–4.0 (1/16–3/16)	No	Reinforcement	No	No
Zigzag stitch (for quilting)		J	Appliqué quilting, free-motion quilting, satin stitching	3.5 (1/8)	0.0–7.0 (0–1/4)	1.4 (1/16)	0.0–4.0 (0–3/16)	No	Reinforcement	Yes	Yes
Appliqué stitch (for quilting)		J	Attaching appliqués and binding	1.5 (1/16)	0.5–5.0 (1/32–3/16)	1.2 (1/16)	1.0–4.0 (1/16–3/16)	No	Reinforcement	No	No
		J	Attaching appliqués and binding	1.5 (1/16)	0.5–5.0 (1/32–3/16)	1.2 (1/16)	1.0–4.0 (1/16–3/16)	No	Reinforcement	No	No
Quilting stitch (for stippling)		J	Quilting background stitching (stippling)	7.0 (1/4)	1.0–7.0 (1/16–1/4)	1.6 (1/16)	1.0–4.0 (1/16–3/16)	No	Reinforcement	No	No
Cross-stitches		N	For decoration, etc.	6.0 (15/64)	0.0–7.0 (0–1/4)	2.5 (3/32)	0.2–4.0 (1/64–3/16)	No	Reinforcement	No	No
		N	For decoration, etc.	6.0 (15/64)	0.0–7.0 (0–1/4)	1.4 (1/16)	0.2–4.0 (1/64–3/16)	No	Reinforcement	No	No

Stitch Name	Pattern	Presser Foot	Application	Stitch Width [mm (inch.)]		Stitch Length [mm (inch.)]		Twin Needle	Reverse/Reinforcement Stitching	Walking Foot	Side cutter
				Auto	Manual	Auto	Manual				
Decorative stitches	42 <sup>N</sup> 	N	For decoration, etc.	7.0 (1/4)	0.0–7.0 (0–1/4)	2.5 (3/32)	0.2–4.0 (1/64–3/16)	No	Reinforcement	No	No
	43 <sup>N</sup> 	N	For decoration, etc.	7.0 (1/4)	0.0–7.0 (0–1/4)	2.0 (1/16)	0.2–4.0 (1/64–3/16)	No	Reinforcement	No	No
	44 <sup>N</sup> 	N	For decoration, etc.	7.0 (1/4)	0.0–7.0 (0–1/4)	2.5 (3/32)	0.2–4.0 (1/64–3/16)	No	Reinforcement	No	No
	45 <sup>N</sup> 	N	For decoration, etc.	7.0 (1/4)	0.0–7.0 (0–1/4)	2.5 (3/32)	0.2–4.0 (1/64–3/16)	No	Reinforcement	No	No
Satin stitches	46 <sup>N</sup> 	N	For decoration, etc.	7.0 (1/4)	2.5–7.0 (3/32–1/4)	0.4 (1/64)	0.1–1.0 (1/64–1/16)	No	Reinforcement	No	No
	47 <sup>N</sup> 	N	For decoration, etc.	7.0 (1/4)	2.5–7.0 (3/32–1/4)	0.4 (1/64)	0.1–1.0 (1/64–1/16)	No	Reinforcement	No	No
	48 <sup>N</sup> 	N	For decoration, etc.	7.0 (1/4)	2.5–7.0 (3/32–1/4)	0.4 (1/64)	0.1–1.0 (1/64–1/16)	No	Reinforcement	No	No
	49 <sup>N</sup> 	N	For decoration, etc.	7.0 (1/4)	2.5–7.0 (3/32–1/4)	0.4 (1/64)	0.1–1.0 (1/64–1/16)	No	Reinforcement	No	No

## Maintenance

Simple sewing machine maintenance operations are described below.

### Cleaning the machine surface

If the surface of the machine is dirty, lightly soak a cloth in neutral detergent, squeeze it out firmly, and then wipe the surface of the machine. After cleaning it once with a wet cloth, wipe it again with a dry cloth.



#### CAUTION

- Unplug the power supply cord before cleaning the machine, otherwise injuries or an electric shock may occur.

### Cleaning the shuttle

Sewing performance will suffer if dust collects in the shuttle; therefore, it should be cleaned periodically.

- 1 Turn off the sewing machine.

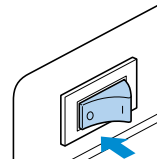

#### CAUTION

- Unplug the power supply cord before cleaning the machine, otherwise injuries or an electric shock may occur.

- 2 Grasp both sides of the needle plate cover, and then slide it toward you.

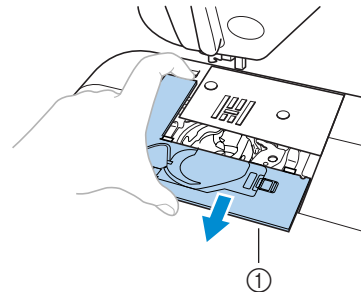

- ① Needle plate cover
- ▶ The needle plate cover is removed.

- 3** Turn the balance wheel toward you until the tip of the shuttle hook aligns with the edge of the race shelf.

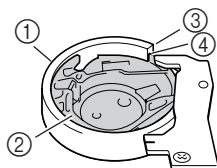

- ① Shuttle race
- ② Shuttle
- ③ Edge of the shuttle hook
- ④ Tip of the shuttle hook

- Be sure to turn the balance wheel toward you. Turning the balance wheel away from you may damage the machine.

- 4** Remove the shuttle. Grasp the shuttle, and then pull it out.

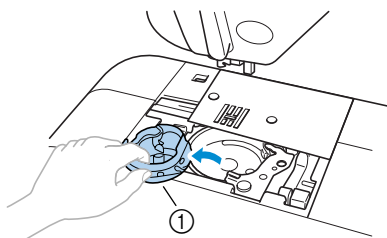

- ① Shuttle

- 5** Use the cleaning brush or a vacuum cleaner to remove any lint and dust from the race and its surrounding area.

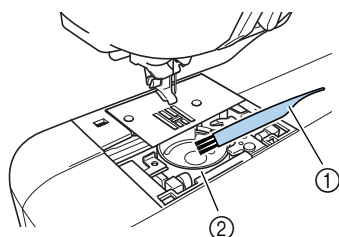

- ① Cleaning brush
- ② Shuttle race

- Do not apply oil to the shuttle.

- 6** Check that the edge of the race shelf is positioned as in step 3, and then insert the shuttle so that the projection on the shuttle aligns with the spring.

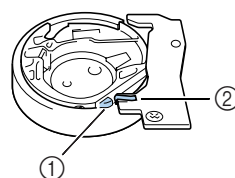
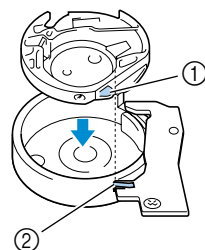

- ① Projection
- ② Spring

- 7** Insert the tabs on the needle plate cover into the needle plate, and then slide the cover back on.

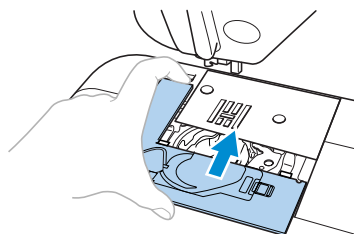

### **!** CAUTION

- Never use a shuttle that is scratched, otherwise the upper thread may become tangled, the needle may break or sewing performance may suffer. For a new shuttle (part code: XC3153-051), contact your nearest authorized service center.
- Be sure that the shuttle is correctly installed, otherwise the needle may break.

## Troubleshooting

If the machine stops operating correctly, check the following possible problems before requesting service. If the problem persists, contact your retailer or the nearest authorized service center.

Symptom	Probable Cause	Remedy	Reference
<b>The sewing machine does not operate.</b>	The machine is not turned on.	Turn on the machine.	page 11
	The start/stop button was not pressed.	Press the start/stop button.	page 39
	The presser foot lever is raised.	Lower the presser foot lever.	–
	The start/stop button was pressed, even though the foot controller is connected.	Do not use the start/stop button when the foot controller is connected. To use the start/stop button, disconnect the foot controller.	page 39
<b>The needle breaks.</b>	The needle is incorrectly installed.	Correctly install the needle.	page 28
	The needle clamp screw is loose.	Use the screwdriver to firmly tighten the screw.	
	The needle is bent or blunt.	Replace the needle.	
	The combination of fabric, thread and needle is not correct.	Select a thread and needle that are appropriate for the type of fabric being sewn.	page 26
	The presser foot that is used is not appropriate for the type of stitch that you wish to sew.	Attach the presser foot that is appropriate for the type of stitch that you wish to sew.	page 92
	The upper thread tension is too tight.	Loosen the upper thread tension.	page 44
	The fabric is pulled too much.	Lightly guide the fabric.	–
	The spool is incorrectly installed.	Correctly install the spool.	page 18
	The area around the hole in the needle plate is scratched, or has a burr on it.	Replace the needle plate. Contact your retailer or the nearest authorized service center.	–
	The area around the hole in the presser foot is scratched, or has a burr on it.	Replace the presser foot. Contact your retailer or the nearest authorized service center.	–
	The shuttle is scratched, or has a burr on it.	Replace the shuttle. Contact your retailer or the nearest authorized service center.	–
A bobbin designed specifically for this machine is not used.	Incorrect bobbins will not work properly. Only use a bobbin designed specifically for this machine.	page 12	



Symptom	Probable Cause	Remedy	Reference
<b>The upper thread breaks.</b>	The upper thread was not threaded correctly (for example, the spool is not installed correctly, the spool cap is too big for the spool being used, or the thread has come out of the needle bar thread hook).	Correct the upper threading.	page 18
	There are knots or tangles in the thread.	Remove any knots or tangles.	–
	The selected needle is not appropriate for the thread being used.	Select a needle that is appropriate for the type of stitch being used.	page 26
	The upper thread tension is too tight.	Loosen the upper thread tension.	page 44
	The thread is tangled, for example, in the shuttle.	Remove the tangle thread. If the thread is tangled in the shuttle, clean the shuttle.	page 96
	The needle is bent or blunt.	Replace the needle.	page 27
	The needle is incorrectly installed.	Correctly install the needle.	
	The area around the hole in the needle plate is scratched, or has a burr on it.	Replace the needle plate. Contact your retailer or the nearest authorized service center.	–
	The area around the hole in the presser foot is scratched, or has a burr on it.	Replace the presser foot. Contact your retailer or the nearest authorized service center.	–
	The shuttle is scratched, or has a burr on it.	Replace the shuttle. Contact your retailer or the nearest authorized service center.	–
<b>The lower thread is tangled or breaks.</b>	A bobbin designed specifically for this machine is not used.	Incorrect bobbins will not work properly. Only use a bobbin designed specifically for this machine.	page 12
	The bobbin thread is incorrectly installed.	Correctly install the bobbin thread.	page 16
	The bobbin is scratched or does not rotate smoothly, or has a burr on it.	Replace the bobbin.	–
	The thread is tangled.	Remove the tangled thread and clean the shuttle.	page 96
<b>The thread tension is incorrect.</b>	A bobbin designed specifically for this machine is not used.	Incorrect bobbins will not work properly. Only use a bobbin designed specifically for this machine.	page 12
	The upper thread was not threaded correctly.	Correct the upper threading.	page 18
	The bobbin thread is incorrectly installed.	Correctly install the bobbin thread.	page 16
	The combination of fabric, thread and needle is not correct.	Select a thread and needle that are appropriate for the type of fabric being sewn.	page 26
	The presser foot holder is incorrectly installed.	Correctly install the presser foot holder.	page 31
	The thread tension is incorrect.	Adjust the tension of the upper thread.	page 44
	A bobbin designed specifically for this machine is not used.	Incorrect bobbins will not work properly. Only use a bobbin designed specifically for this machine.	page 12

Symptom	Probable Cause	Remedy	Reference
<b>The fabric is wrinkled.</b>	The upper thread was not threaded correctly, or the bobbin is incorrectly installed.	Correctly thread the upper thread and correctly install the bobbin thread.	page 16, 18
	The spool is incorrectly installed.	Correctly install the spool.	page 18
	The combination of fabric, thread and needle is not correct.	Select a thread and needle that are appropriate for the type of fabric being sewn.	page 26
	The needle is bent or blunt.	Replace the needle.	page 27
	If thin fabrics are being sewn, the stitch is too coarse.	Shorten the stitch length or sew with stabilizer material under the fabric	page 46
	The thread tension is incorrect.	Adjust the tension of the upper thread.	page 44
<b>Stitches are skipped.</b>	The upper thread was not threaded correctly.	Correct the upper threading.	page 18
	The combination of fabric, thread and needle is not correct.	Select a thread and needle that are appropriate for the type of fabric being sewn.	page 26
	The needle is bent or blunt.	Replace the needle.	page 27
	The needle is incorrectly installed.	Correctly install the needle.	page 28
	Dust has accumulated under the needle plate or in the shuttle.	Remove the needle plate cover and clean the shuttle.	page 96
<b>A high-pitched noise is made while sewing.</b>	Dust has accumulated in the feed dogs or in the shuttle.	Clean the shuttle.	page 96
	The upper thread was not threaded correctly.	Correct the upper threading.	page 18
	The shuttle is scratched, or has a burr on it.	Replace the shuttle. Contact your retailer or the nearest authorized service center.	–
	A bobbin designed specifically for this machine is not used.	Incorrect bobbins will not work properly. Only use a bobbin designed specifically for this machine.	page 12
<b>The needle threader cannot be used.</b>	The needle was not raised.	Press the needle position button to raise the needle.	page 21
	The needle is incorrectly installed.	Correctly install the needle.	page 28
<b>The stitch is not sewn correctly.</b>	The presser foot that is used is not appropriate for the type of stitch that you wish to sew.	Attach the presser foot that is appropriate for the type of stitch that you wish to sew.	page 92
	The thread tension is incorrect.	Adjust the tension of the upper thread.	page 44
	The thread is tangled, for example, in the shuttle.	Remove the tangle thread. If the thread is tangled in the shuttle, clean the shuttle.	page 96

Symptom	Probable Cause	Remedy	Reference
<b>The fabric does not feed.</b>	The feed dogs are lowered.	Slide the drop feed lever to the left.	page 67, 81
	The stitch is too fine.	Lengthen the stitch length.	page 46
	The presser foot that is used is not appropriate for the type of stitch that you wish to sew.	Attach the presser foot that is appropriate for the type of stitch that you wish to sew.	page 92
	The pressure of the presser foot is weak.	Turn the presser foot pressure dial to the right to increase the pressure of the presser foot.	page 30
	The thread is tangled, for example, in the shuttle.	Remove the tangle thread. If the thread is tangled in the shuttle, clean the shuttle.	page 96
<b>The sewing lamp does not come on.</b>	The sewing lamp is damaged.	Contact your retailer or the nearest authorized service center.	–

## Error messages

If the start/stop button is pressed before the sewing machine is correctly set up or if an operation is performed incorrectly, an error message appears in the stitch indicator. Follow the instructions that appear.

If you press  (Stitch selection key) or do the operation correctly while the error message is displayed, the message disappears.

Error Message	Probable Cause
<i>E1</i>	The start/stop button or reverse/reinforcement stitch button was pressed while the presser foot was raised.
<i>E2</i>	A stitch other than the buttonhole or bar tack stitch was selected and the start/stop button was pressed while the buttonhole lever is lowered.
<i>E3</i>	The buttonhole or bar tack stitch was selected and the start/stop button was pressed while the buttonhole lever is raised.
<i>E4</i>	The reverse/reinforcement stitch button or needle position button was pressed while the bobbin winder shift is moved to the right.
<i>E5</i>	The start/stop button was pressed while the foot controller was connected.
<i>E6</i>	The motor locked up because the thread is tangled.

## Operation beep

Each time a key is pressed or an incorrect operation is performed, a beep is sounded.

- **For a correct operation**

One beep is sounded.

- **If an incorrect operation is performed**

Two or four beeps are sounded.

- **If the machine locks up, for example, because the thread is tangled**

The sewing machine continues to beep for four seconds. The machine automatically stops.

Be sure to check for the cause of the error, and correct it before continuing to sew.

## Removing the upper cover

If the upper cover of the sewing machine was removed, re-attach it as described in the following procedure.

- 1 **Hold the upper cover level.**

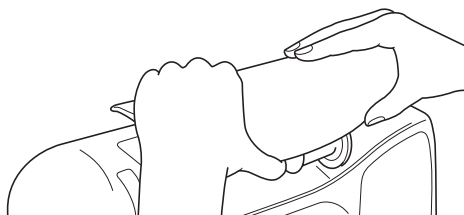

- 2 **Push the upper cover down to re-attach it to the machine.**

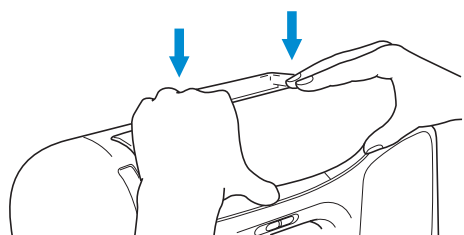

# Index

## Numerics

3-point zigzag stitch ..... 57

## A

accessories ..... Cover A  
adjustable zipper/piping foot ..... 1  
air vent ..... Cover C  
appliques ..... 77  
automatic reinforcement stitching ..... 47  
automatic reverse stitching ..... 47  
automatic reverse/reinforcement stitch key ..... Cover E

## B

balance wheel ..... Cover C, 38  
bar tack ..... 82  
basic stitching ..... 60  
blind hem stitch ..... 61  
blind stitch foot ..... Cover A  
bobbin ..... Cover A, 16  
bobbin cover ..... Cover C, 16  
bobbin thread ..... 16  
    pulling up ..... 25  
bobbin winder ..... Cover B, 13  
bobbin winder seat ..... 14  
bobbin winder shaft spring ..... 13  
bobbin-winding ..... 12  
button fitting foot ..... Cover A  
button sewing ..... 67  
buttonhole foot ..... Cover A, 64  
buttonhole lever ..... Cover C, 65, 83  
buttonhole stitching ..... 63

## C

changing sewing direction ..... 49  
changing the needle ..... 28  
cleaning ..... 96  
cleaning brush ..... Cover A, 97  
crazy quilt stitching ..... 78  
cross-wound thread ..... 13  
curves ..... 49  
cylindrical pieces ..... 33

## E

elastic tape ..... 74  
electrical outlet ..... 11  
error messages ..... 101  
even seam allowance ..... 51  
extra spool pin ..... 23  
eyelet ..... 84  
eyelet punch ..... Cover A, 66, 84

## F

fagoting ..... 86  
features ..... 2  
feed dog position switch ..... Cover C, 81  
feed dogs ..... Cover C, 80  
foot controller ..... Cover A, 39  
foot controller jack ..... Cover C  
free-arm sewing ..... 33  
free-motion quilting ..... 80  
front view ..... Cover B

## H

handle ..... Cover C  
hard case ..... Cover A  
heirloom stitching ..... 89

## J

joining ..... 88  
joining stitch ..... 76

## L

lower threading ..... 16

## M

main power switch ..... Cover C, 11  
maintenance ..... 96  
monogramming foot ..... Cover A

## N

needle ..... 26  
needle bar thread hook ..... Cover C, 20  
needle clamp screw ..... 28  
needle plate ..... Cover C, 51  
needle plate cover ..... 96  
needle position ..... 60  
needle position button ..... Cover D  
needle set ..... Cover A  
needle stop position key ..... Cover E  
needle threader lever ..... Cover B, 21  
non stick foot ..... 1

## O

open toe foot ..... 1  
openings ..... 82  
operation beep ..... 102  
operation buttons ..... Cover B, Cover D  
operation manual ..... Cover A  
operation panel ..... Cover B  
optional accessories ..... 1  
overcasting foot ..... Cover A  
overcasting stitches ..... 56

**P**

patchwork stitching .....	78
piecing .....	78
pocket corners .....	82
positioning fabric .....	38
presser foot .....	Cover C, 29
presser foot dial .....	Cover C, 30
presser foot holder .....	Cover C, 31
presser foot lever .....	Cover D
presser foot pressure .....	30

**Q**

quick reference guide .....	Cover A
quilting .....	79
quilting foot .....	1, 80
quilting guide .....	1, 79, 80

**R**

rear view .....	Cover C
reinforcement stitching .....	41, 82
reverse/reinforcement stitch button .....	Cover D

**S**

scallop stitching .....	87
screwdriver .....	Cover A, 28
seam ripper .....	Cover A, 66
selecting stitching .....	54
sewing machine needles .....	26
sewing speed .....	39
sewing speed controller .....	Cover B, Cover D
shutter .....	20
shuttle .....	16, 96
shuttle hook .....	97
side cutter .....	1, 58
side view .....	Cover C
sleeves .....	82
smocking .....	87
spool cap .....	Cover A, 13, 19
spool net .....	Cover A, 24
spool pin .....	Cover B, 13, 19
start/stop button .....	Cover D, 39
starting sewing .....	39
stitch guide foot .....	1
stitch indicator .....	Cover E
stitch length .....	46
stitch length adjustment button .....	Cover E
stitch length adjustment slider .....	Cover E
stitch settings .....	92
stitch width .....	45
stitch width adjustment button .....	Cover E
stitch width adjustment slider .....	Cover E
stitches .....	Cover E
straight stitch .....	60
stretch fabrics .....	51

**T**

thick fabrics .....	50
thin fabrics .....	51
thread cutter .....	Cover B
thread guide cover .....	Cover B, 14, 20
thread guide discs .....	Cover C, 21
thread guide for bobbin winding .....	Cover B, 14
thread guide plate .....	Cover B, 14, 20
thread tension .....	44
thread tension dial .....	Cover B, 44
thread that quickly unwinds .....	24
trial sewing .....	49
triple stretch stitch .....	82
troubleshooting .....	98
twin needle .....	Cover A, 22, 28

**U**

upper cover .....	Cover B, 13, 19
upper thread .....	18
upper thread tension .....	44

**W**

walking foot .....	1, 31, 79
wide table .....	1, 33
wing needle .....	89

**Z**

zigzag foot .....	Cover A
zipper foot .....	Cover A
zipper stitching .....	70

