

P-TOUCH

Model PT-12/15

brother

USER'S GUIDE

INTRODUCTION

This machine will help you design and print labels for any application. Extremely versatile, it can create characters of many sizes and styles. In addition, with the use of colorful tape cartridges, you can print labels with a variety of letter and background colors.

You no longer have to worry about rushing tasks that require professional-type printing. The quality and performance of this machine make it very versatile.

Although this machine is easy to use, we suggest that you read this manual carefully before starting. Please keep the manual in a handy place for future reference.

Good luck! We hope you enjoy making beautiful custom labels.

FCC NOTICE

This equipment has been tested and found to comply with the limits for a Class B digital device, pursuant to Part 15 of the FCC Rules. These limits are designed to provide reasonable protection against harmful interference in a residential installation. This equipment generates, uses, and can radiate radio frequency energy and, if not installed and used in accordance with the instructions, may cause harmful interference to radio communications. However, there is no guarantee that interference will not occur in a particular installation. If this equipment does cause harmful interference to radio or television reception, which can be determined by turning the equipment off and on, the user is encouraged to try to correct the interference by one or more of the following measures:

- Reorient or relocate the receiving antenna
- Increase the separation between the equipment and receiver.
- Connect the equipment into an outlet on a circuit different from that to which the receiver is connected.
- Consult the dealer or an experienced radio/television technician for help.

Patent numbers and patent publication numbers which are related to this product are as below:

USP4839742	USP4983058	EP315369 (Pending)	GB2223740
USP4922063	USP5009530	EP322918	
USP4927278	USP5069557	EP322919	
USP4966476	USP5120147		
USP4976558			

CONTENTS

GENERAL OVERVIEW	2
GENERAL PRECAUTIONS	6
BEFORE YOU START	7
SELF DEMONSTRATION	7
LETTERING STICK	7
INSERTING A TAPE CASSETTE	8
INSERTING BATTERIES	9
CHANGING THE CUTTER UNIT	10
STARTING	11
CREATING A MESSAGE	12
DISPLAY	12
MOVING THE CURSOR	12
CLEARING THE DISPLAY	13
KEY OPERATIONS	14
INPUT	15
SPACE KEY	15
SYMBOLS	17
EDITING A MESSAGE	20
DELETING	20
WORD OUT	21
OVER TYPING	22
INSERTING	23
PRINTING A LABEL	25
SIZE	27
STYLE	29
UNDERLINE/FRAME	31
TAPE FEED	32
PRINTING & CUTTING	33
MIRROR PRINTING	34
CHARACTER DENSITY	35
REPEAT PRINTING	36
REMOVING LABEL BACKING	37
INSTANT LETTERING TAPE (RUB-ON CHARACTERS)	37
IRON ON TRANSFER TAPE	38
PHRASE MEMORY OPERATION	41
PHRASE MEMORY	41
MEMORY SIZE	41
STORING THE MESSAGE	41
RECALLING THE PHRASE MEMORY	43
DELETING THE PHRASE MEMORY	45
MESSAGE LIST	47
TROUBLESHOOTING	48
SPECIFICATIONS	49
ACCESSORIES	50

GENERAL OVERVIEW

– P-Touch 12–

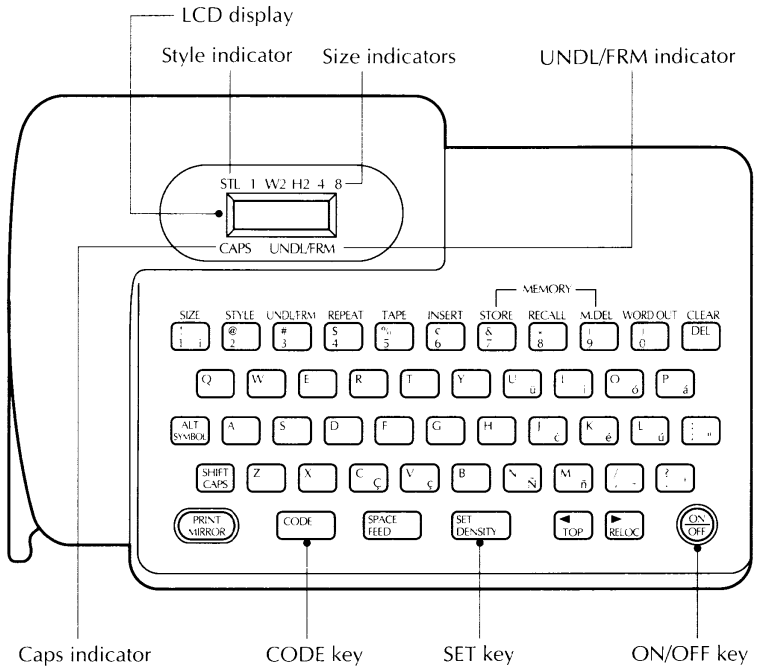

To use functions written in purple you must hold down the CODE key and press the desired function key.

Tape cutter lever

Release lever

Battery compartment

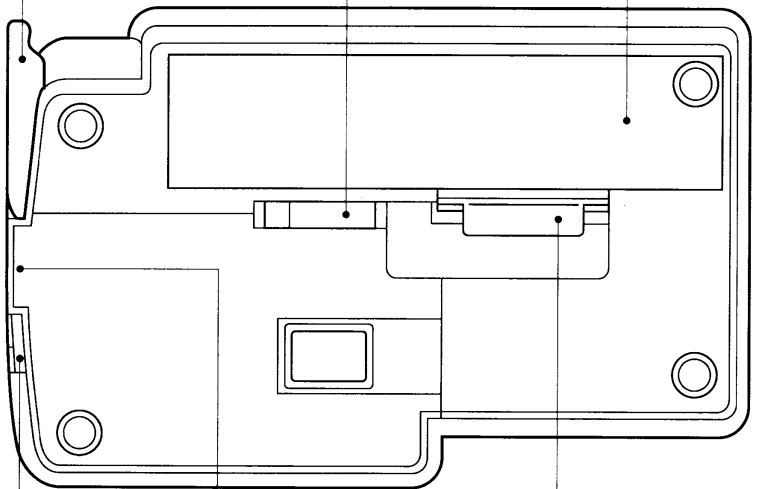

Tape cassette
compartment

Tape exit slot

Battery compartment latch

- P-Touch 15-

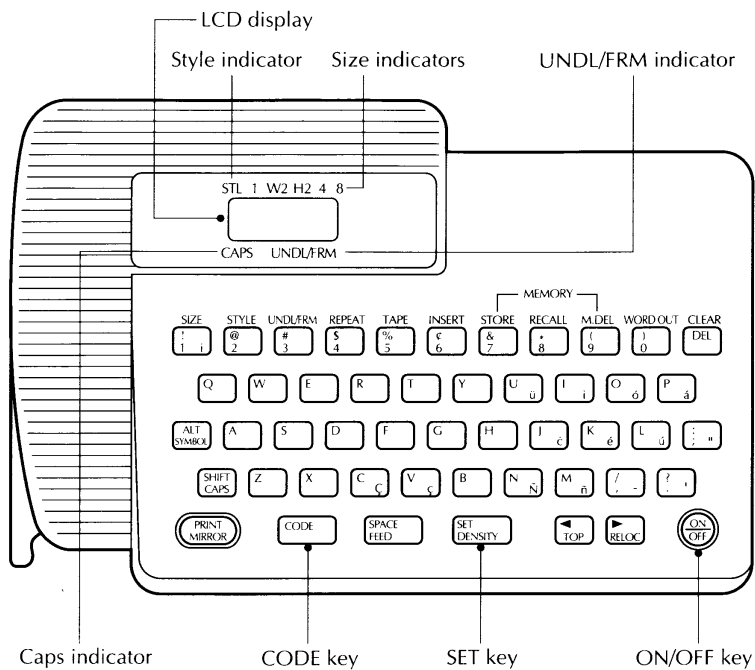

To use functions written in purple you must hold down the CODE key and press the desired function key.

Tape cutter lever

Release lever

Battery compartment

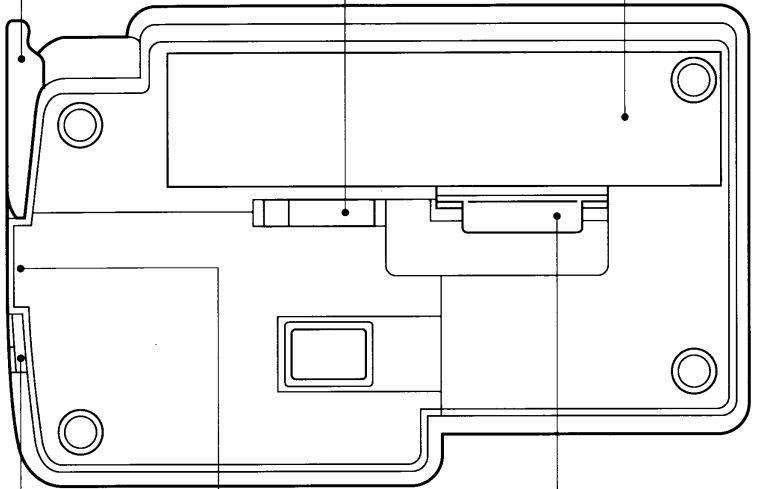

Tape cassette
compartment

Tape exit slot

Battery compartment latch

GENERAL PRECAUTIONS

- Do not pull the tape. This may damage the tape cassettes.
- Do not clean the machine with alcohol or other organic solvents. Use only a soft, dry cloth.
- Do not put anything onto or into the machine.
- Do not expose the machine to high temperatures or high humidity. Never leave it on the dashboard or in the trunk of your car.
- Do not use the machine in dusty places. Keep it out of both direct sunlight and rain.
- Remove the batteries and/or disconnect the AC Adaptor if you do not intend to use your machine for an extended period of time.
(Note: When power is disconnected for more than three minutes, any messages in the working area or the Message Memory area will be lost.)
- Do not leave any rubber or vinyl on the machine for an extended period of time. Doing so may cause staining.
- Use only an AC Adaptor, Model AD-20 or AD-30 designed exclusively for the P-touch.
- After inserting a new tape cassette, advance the tape by holding down the **CODE** key and pressing the **FEED** key once.
- Do not attach the adhesive label to your skin.
- Do not touch the print head mechanism. If the head is touched, clean it immediately with a soft wipe (e.g.cotton swab) to avoid permanent damage.
- Be sure the cutter lever is not opened slightly when printing.
- Most P-Touch tapes are 25' long. Silver tape signals the end of a cassette. When silver tape appears, immediately turn the machine off and replace the tape.
- Always remove the paper stopper from a new tape cassette before inserting it into the machine.
- Before installing a new tape, you may tighten any slack by turning it in the direction shown on the cover. Only turn once or twice; do not over-tighten.

BEFORE YOU START

SELF DEMONSTRATION

This unit has a built in self demonstration. Pressing the **CODE + D** keys will print the self demonstration as follows:

P-TOUCH LABELS FOR HOME, OFFICE... ANYWHERE!

If there is a message on the display, this function cannot be used. Press the **CODE + CLEAR** keys to clear the message before printing the self demonstration.

LETTERING STICK

A lettering stick is enclosed in this package. This stick is convenient when you use instant lettering tape (see page 37). In addition, it can help you remove label backing easily.

INSERTING A TAPE CASSETTE

A tape cassette is supplied with this unit.

To insert a new tape cassette:

- (1) Turn the machine over. Remove the tape cassette compartment cover by pressing in the scored portion and lifting.
- (2) If there is an empty tape cassette in the compartment, pull up the release lever. Pull the used tape cassette straight up to remove it.
- (3) Remove the stopper from the new tape cassette. Use your finger to wind it in the direction of the arrow on the case two full times.
- (4) Insert the new tape cassette firmly into the compartment. Replace the compartment cover. Push down the release lever to lock the tape into place.
- (5) Advance the tape by holding down the **CODE** key and pressing the **FEED** key once.

- Note:**
- When inserting a tape cassette, make sure that the inner ribbon does not get caught on the corner of the metal securing stand.
 - Never push or pull on the small blue pin in the tape cassette compartment.
 - Never pull on the tape after it has been printed. Always use the cutter lever. Pulling the tape may cause a feed jam.

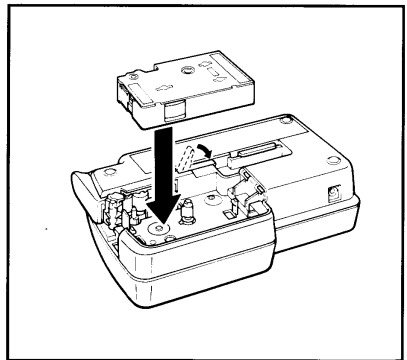
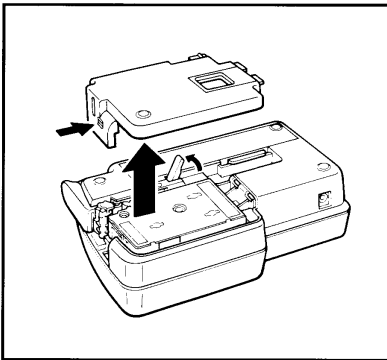

INSERTING BATTERIES

The machine uses six AA (SUM3/R6/LR6) batteries.

To insert batteries:

- (1) Turn the machine over. Remove the battery compartment cover by pinching the latch and lifting.
- (2) Follow the diagrams on the back of the compartment to insert the batteries in the proper direction.
- (3) After inserting the batteries, re-fit the battery compartment cover.

When "B.WEAK" (Batteries Weak) is displayed, replace the six batteries.

- Alkaline batteries are recommended.
- Optional AC Adaptors are available. (AD-20 or AD-30)

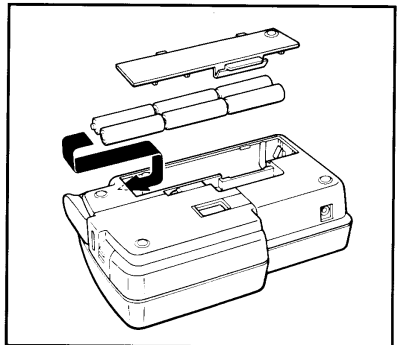
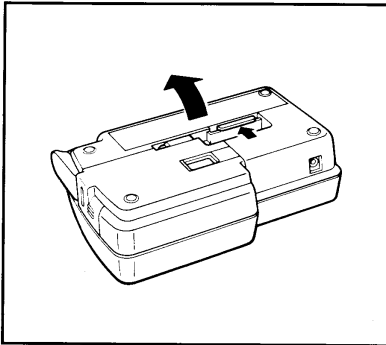

Note: When replacing batteries, do so in three minutes or less. Otherwise, unless an optional AC Adaptor is attached, all messages in the working area and Phrase Memory will be lost.

CHANGING THE CUTTER UNIT

When the cutter no longer cuts well, replace it with a new blade.

To replace a dull or broken blade:

- (1) Turn the machine over. Open the tape cassette compartment cover. Pull up the tape cassette release lever. If a tape cassette is installed, carefully remove it. Push the empty side of the replacement unit down to grasp the old cutter.
- (2) Pull the replacement unit up to remove the cutter.
- (3) Turn the replacement unit over and line up the plastic teeth of the new cutter unit with the teeth on the machine's gear.
- (4) Push the replacement unit down to insert the new cutter into the machine.
- (5) Replace the compartment cover.
- (6) Push down the yellow release lever.

Refer to the Accessory List on page 52 for purchasing new blades.

Note: *The expected life of the unit's cutter is approximately 3000 cuts.*

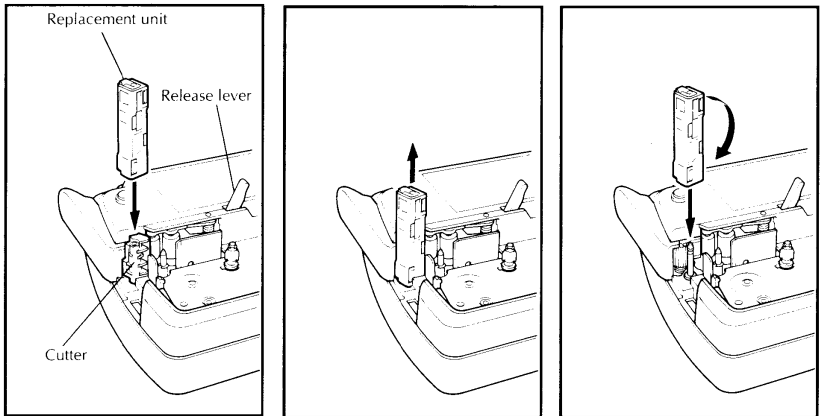

STARTING

To start the machine:

Press the ON/OFF key.

The machine's internal memory retains the last message created, and displays it when you turn on the machine. This feature allows you to stop work on a message, turn off the machine, and return to it later without having to re-enter the message.

The machine has an automatic power down feature. If the machine is on, but is not used for five minutes, it will automatically shut off. The message will be retained in memory until the machine is turned on again.

CREATING A MESSAGE

DISPLAY

You are now ready to create a message on the machine.

The machine's LCD display is six characters wide. Actually though, you can create messages up to 55 characters in length. The six-character display is like a window which moves across your message.

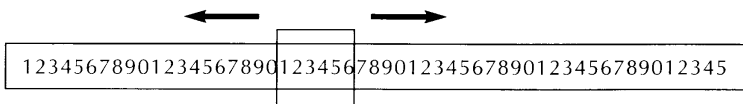

MOVING THE CURSOR

You can review and edit different parts of your message by moving the cursor backward and forward.

To move the cursor through your message:

Press the ◀ and ▶ keys to move the cursor one space at a time.

Hold down the **CODE** key and press the **TOP** key to return the cursor to the beginning of the message. Hold down the **CODE** key and press the **RELOC** key to advance the cursor to the end of the message.

CLEARING THE DISPLAY

Before entering a new message, you will often need to clear an old message.

To erase the previous message from the display:

Hold down the **CODE** key and press the **CLEAR** key.

In the following examples, we will work through a sample message, first creating it, then editing it, printing it, and finally storing it in the machine's memory.

For the purpose of this example, suppose you are J. Smith, and you want to make a label with your name on it.

Example ● Erase any message from the display by pressing

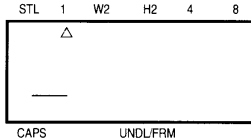

KEY OPERATIONS

CODE KEY

By holding down the **CODE** key and pushing the appropriate key, you can use the functions written in purple (PT-12) or green (PT-15).

SHIFT KEY

By using the **SHIFT** key you can type capital letters, and symbols located on the upper part of keys. To type a capital "A", hold the **SHIFT** key down and push the "A" key. To type a "%" sign (located above the "5"), hold the **SHIFT** key down and push the "5" key.

CAPS KEY

By holding down the **CODE** key and pressing the **CAPS** key, you set the machine into CAPS mode. When this mode is entered, the triangular CAPS indicator on the display turns on. In CAPS mode, capital letters can be typed simply by pressing the character keys. If number keys are pressed, numbers -- not the symbols above them -- result. For this reason, CAPS mode is particularly useful for creating messages containing many numerals and capital letters. To exit CAPS mode, press the **CODE** key and the **CAPS** key again.



ALT KEY

By using the **ALT** key you can type various symbols marked on the keys in red. To type a symbol located on the right side of a key, hold down the **ALT** key and press the key on which the desired symbol is marked.



INPUT

You can now use the keys to enter a message.

Example To input "Mr.":

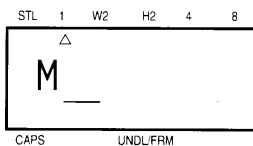
- Press  +  to input a capital M.



- Complete "Mr." by pressing  then .

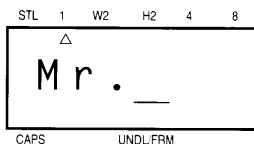

SPACE KEY

As on a typewriter, this machine's **SPACE** key lets you add a blank space into your message.



Note: The **SPACE** key and the **▶** key have different functions. The **▶** key moves the cursor forward without adding blank spaces.

Example To complete the message "Mr. J Smith":

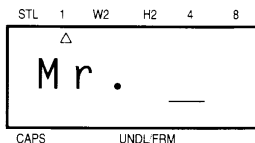
- Press  once to add a blank space.



Next enter the initial "J":

- Press  +  to input a capital J.
- Add a blank space by pressing  once.

Note: The "M" will move off of the display.

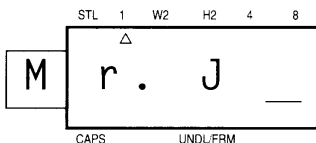

- Complete the message by entering "Smith".

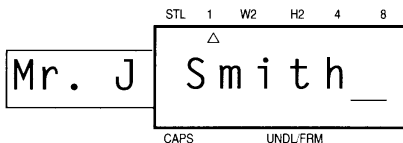

- If you make any mistakes during this input do not worry.

Simply press  to remove the last character, and type again.

SYMBOLS



In addition to the 97 letters, numerals and symbols on the key tops, there are an additional 27 symbols available in Symbol Mode. These 27 additional symbols are arranged into five groups, corresponding to the letters A to E on the keyboard.

A	Ü	Æ	æ	ä	ö	
B	×	÷	[]	+	=
C	§	²	³	$\frac{1}{2}$	•	°
D	↑	↓	→	←		
E	T M	®	©	★	♥	☺

To input a symbol that is not on the key top:

- (1) Hold down the **CODE** key and press the **SYMBOL** key to enter Symbol Mode.
- (2) The display will read: "A-E key".
- (3) Press the key of the letter from A to E whose group contains the symbol you want. That letter's group of symbols will be displayed.
- (4) Move the cursor to the symbol you want.
- (5) Press the **SET** key.

Example To add a star (★) to the message, changing the message to “Mr. J Smith ★”:

- Enter Symbol Mode by pressing  + .
- The following message will be displayed:

STL 1 W2 H2 4 8
△
A - E key
CAPS UNDL/FRM

- Press the E key, as its group includes the ★ symbol.
(Refer to the symbol chart on Optional page.)

STL 1 W2 H2 4 8
△
T M ® © ★ ♥ ☺
CAPS UNDL/FRM

- Move the cursor to ★ by pressing .

STL 1 W2 H2 4 8
△
T M ® © ★ ♥ ☺
CAPS UNDL/FRM

- Push **SET DENSITY** to input a ★.

The message should now look like this:

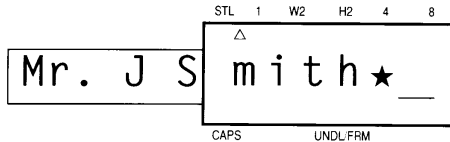

After a non-keyboard symbol has been entered, the machine automatically exits from Symbol Mode. If you wish to enter another symbol, you must re-enter Symbol Mode by holding down the **CODE** key and pressing the **SYMBOL** key.

EDITING A MESSAGE

DELETING

The **DELETE** key allows you to remove characters from your message.

To delete a character:

- (1) Using the ◀ and ▶ keys, position the cursor one space to the right of the character you want to delete.
- (2) Press the **DELETE** key.

After deletion, the cursor stays in the same position until all remaining characters to its left appear on the display.

If further deletions are made, the cursor and all characters following the deletion (including blank spaces) move one space to the left.

Example To delete the ★ from the message:

- Make sure the cursor is positioned to the right of the ★.

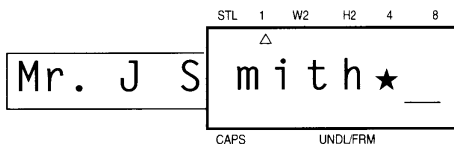

- Press  to remove the ★.

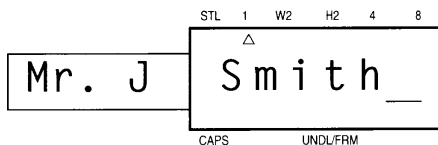

WORD OUT

This function allows you to erase one word at a time, simplifying the editing of long messages.



To use the WORD OUT function:

- (1) Position the cursor to the right of the word (and space, if any) you want to delete.
- (2) Hold down the **CODE** key and press the **WORD OUT** key.

Example To delete the word "Mr." from the message:

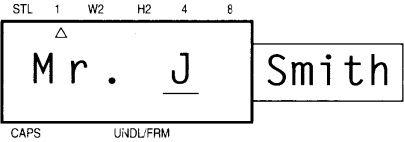
- Press  to position the cursor under "J".



- Press  + .

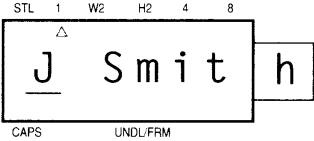

OVER TYPING

The machine normally operates in Overtyping Mode. In Overtyping Mode, you can change a character simply by typing a new one in its place.

To type over a character:

- (1) Move the cursor to the character you want to change.
- (2) Press the character or symbol you want.

The new character replaces the old one in the message.

Example To replace the lower-case letters "mith" with capital letters:

- Position the cursor under the "m".

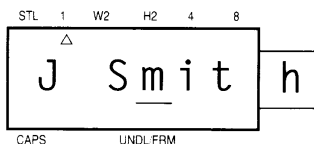

- Switch to CAPS Mode by pressing **CODE** + **SHIFT CAPS**.
The CAPS indicator will light.

- Press the **M** key.

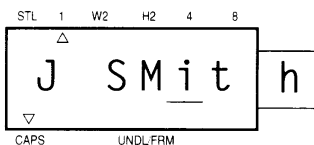

- Complete the process by typing the letters "ITH".

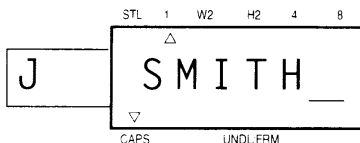

INSERTING

Sometimes you may want to insert a character into the middle of your message. To do so, you must change from Overtyping Mode to Insert Mode.

To insert characters:

- (1) Hold down the **CODE** key and press the **INSERT** key so that display shows "I: ON".
- (2) Move the cursor to the position before which you want to insert.
- (3) Press the keyboard character or symbol you want to add, or choose an auxiliary symbol in Symbol Mode (see SYMBOLS).

All characters following the insertion will move one space to the right.

Example To insert a period into the message, changing it to "J. SMITH":

- Position the cursor under the blank space between the "J" and the "S".

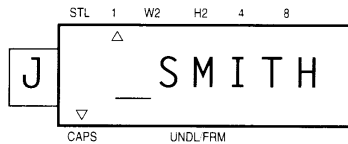

- Enter Insert Mode by pressing **CODE** + **INSERT** (c b).
- Pressing the **INSERT** (c b) key while holding down the **CODE** key toggles between two displays.

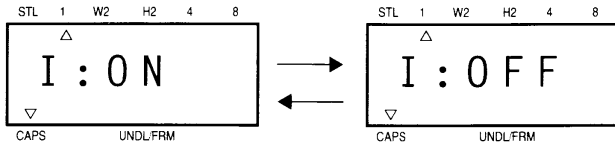

- Release the CODE key when the display shows "I:ON".
- Press the period key.

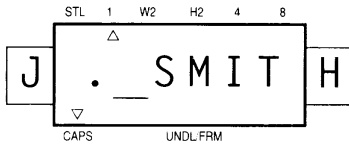

To leave INSERT Mode:

You can leave Insert Mode by holding down the **CODE** key and pressing the **INSERT** key twice.

When you leave Insert Mode, you automatically return to Overwrite Mode.

PRINTING A LABEL

You can print your completed message using a variety of different character sizes and styles.

Choose character size and style before printing the label.

Note: *The type of character you choose will be used for all the characters in your message. It is not possible to have two different character sizes or styles within one message.*

Various print sizes and styles available on this machine:

Standard Size Normal

J. SMITH

Standard Size Vertical

**J
·
S
M
I
T
H**

Double Height Normal

J. SMITH

Double Width Normal

J. SMITH

Double Width & Double Height Normal

J. SMITH

4 x Width & Double Height Normal

J. SMITH

4 x Width & Double Height Outline

J. SMITH

4 x Width & Double Height Bold

J. SMITH

4 x Width & Double Height Shadow

J. SMITH

SIZE

There are five different character sizes you can select for your label:

1 - Standard Size

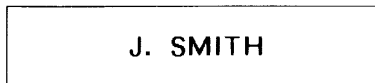

W2 - Double Width



H2 - Double Height



4 - Double Width & Double Height



8 - 4 x Width & Double Height



To choose a character size:

- (1) Holding down the **CODE** key, press the **SIZE** key to change the character size and advance the size indicator on the display in the following order:

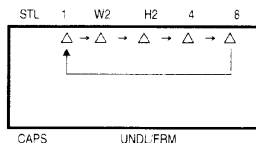

CAPS

UNDLFRM

(2) Stop pressing the **SIZE** key when your desired character size is indicated.

Example To use Double Width and Double Height (4) characters:

- Hold down and press until the size indicator is aligned with the 4.

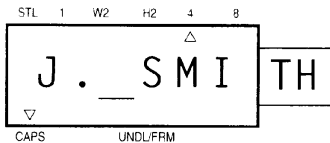

STYLE

There are also five different print styles:

1 - Normal

J. SMITH

2 - Outline (O.LINE)

J. SMITH

3 - Bold

J. SMITH

4 - Shadow

J. SMITH

5 - Vertical (VERTCL)

J. SMITH

To choose a print style for your label:

- (1) Holding down the **CODE** key, press the **STYLE** key once. The display will show the current print style.
- (2) Still holding down the **CODE** key, press the **STYLE** key again. The available print styles will appear in order.
- (3) When the style you want is displayed, release the **CODE** key.

If you select a style other than Normal, the style indicator will be visible on the display.

Note: Only Normal style characters can be printed vertically.

Example To use Outline print:

- Hold down .
- Press until the display reads "O.LINE".

The style indicator will turn on.

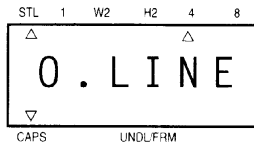

- Release .

UNDERLINE/FRAME

You can add an underline or framing to text when you wish to emphasize it.

To add underlining or framing.

- (1) Holding down the **CODE** key, press **UNDERLINE/FRAME** () key.
- (2) The current status will be shown on the display.
- (3) Still holding the **CODE** key, press the **UNDL/FRM** key again to change the setting.

It will change as follows:

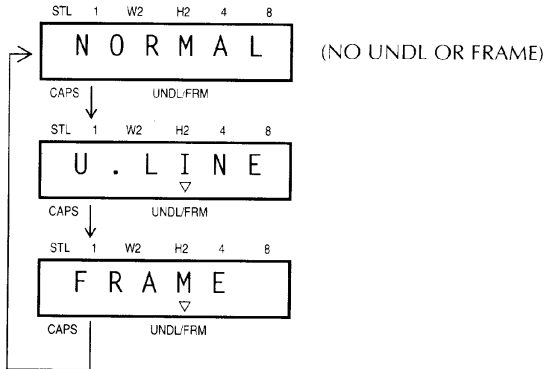

- Note:**
- Underline & Frame are not available simultaneously.
 - Underline & Frame are not available when you choose Vertical Printing.

A triangle indicator on the display appears when either Underlining or Framing is on.

TAPE FEED

The machine normally advances the tape after printing. Sometimes, however, you may want to add characters to the end of the message you have printed. To do so, you must change the Auto Tape Feed Mode from "ON" to "OFF" before printing.

To change the TAPE FEED Mode:

- (1) Press the **CODE** key and the **TAPE** key.
- (2) The current feed mode appears on the display.
- (3) Still holding down the **CODE** key, press the **TAPE** key again. The display changes between the following two messages:

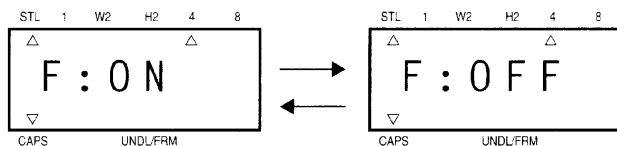

- (4) When the mode you want (Feed "ON" or "OFF") is displayed, release the **CODE** key.

- Note:**
- If you want to print a label that contains more than 55 characters, you may want to turn the feed off. You can then print the label in stages, without gaps in the text.
 - To manually feed the tape when done, hold down the **CODE** key and press the **FEED** key.

Example To use Automatic Tape Feed:

- Hold down **CODE** and press **5** until the display reads "F:ON".
- Release **CODE**.

PRINTING & CUTTING

After you have chosen the character size, print style, underlining/framing and tape feed style, you are ready to print the label.

To print a label:

Press the **PRINT** key.

The printed label comes out of the tape exit slot on the side of the machine.

Example To print the message onto a label:

- Press **PRINT MIRROR**.

A label reading "J. SMITH" written in Double Width & Double Height Outline characters will be printed.

J. SMITH

To cut the tape:

Pull out the tape cutter lever on the side of the machine.

- Note:**
- Do not pull on the tape. This may damage the tape cassette.
 - *If you pull out the tape cutter lever too far, it may break.*
 - *Do not attempt to cut the tape during printing or feeding.*

Example To cut the label:

- Pull out the tape cutter lever.

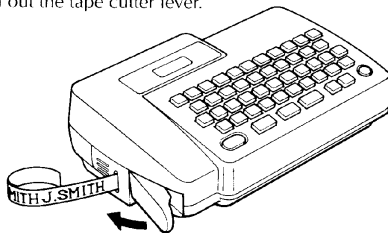

MIRROR PRINTING

When the mirror printing function is used, characters are printed so they are legible from the adhesive side of the tape. If the labels are then attached to glass or some other transparent material, they can be read correctly from the opposite side. This type of label is particularly useful for attachment to the inside of shop windows or clear notebooks, so that it can be read from the outside. For this application, transparent tape must be used.

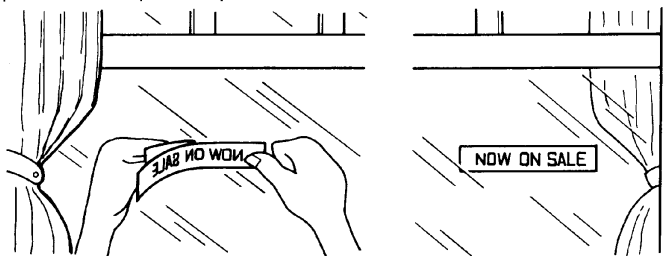

Mirror-printed labels attached inside the window can be read from the street.

To use Mirror Printing:

- (1) Holding down the **CODE** key, press the **MIRROR** () key.
- (2) The current mirror print mode (On or Off) appears on the display.
- (3) Still holding down the **CODE** key, press the **MIRROR** key again. The display changes between the following two messages:

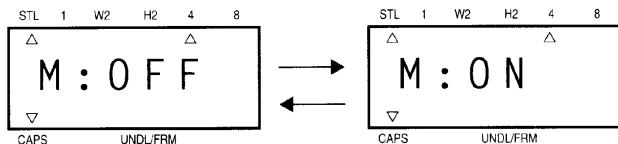

- (4) If you want to use Mirror Printing, release the **CODE** key when "M:ON" is displayed. To use regular printing, release the **CODE** key when "M:OFF" is displayed.

CHARACTER DENSITY

The machine is pre-set to print well in normal temperatures. When using the machine in extremely cold or hot environments, you may occasionally need to adjust the print density to perfect the output.

You can select any of five printing densities using the DENSITY function.

To select a Character Density

- (1) Holding down the **CODE** key, press the **DENSITY** (**SET DENSITY**) key once.
- (2) Still holding down the **CODE** key, press the **DENSITY** key again. Scroll through the available density settings as follows:

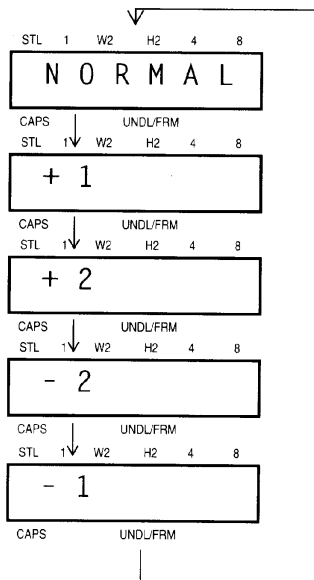

When printed characters are faint (low temperature) → use +1, +2

When printed characters are smudged (high temperature) → use -1, -2

- (3) When the density you would like to select is displayed, release the **CODE** key.

- Note:**
- When the power is turned off, the density will be set back to **NORMAL** automatically.
 - When printing labels in high temperatures, never set print density to "+2". If you do so, the tape's ink ribbon may tear.

REPEAT PRINTING

The Repeat function allows you to repeatedly print the same label up to ten times with only one press of the key.

To use the REPEAT PRINTING function:

- (1) Hold down the **CODE** key and press the **REPEAT** () key.
- (2) The following message appears on the display:

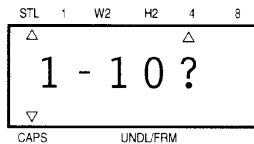

- (3) Select the number of labels you want. For example, if you want ten labels to be printed, type 10.
- (4) Press print.

Note:

- A maximum of ten copies can be printed.
- Cutting is not done automatically.
- A 4-mm space will be left between repeated messages even if Auto Tape Feed is Off. If Auto Tape Feed is On, normal, even margins will be left on both sides of each message.
- **Never try to cut the tape during printing.**
- **Press the ON/OFF key immediately if the tape runs out before all printing is finished.**

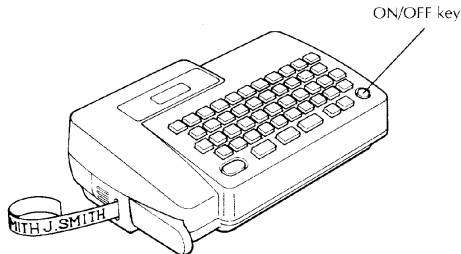

REMOVING LABEL BACKING

The enclosed stick enables the label backing of the tape to be removed easily.

- (1) Hold the label in one hand with the printed surface up, and hold the stick in the other hand.
- (2) Pass the tape halfway through the long narrow hole of the stick.
- (3) After turning the stick inward halfway, pull the stick to the right.

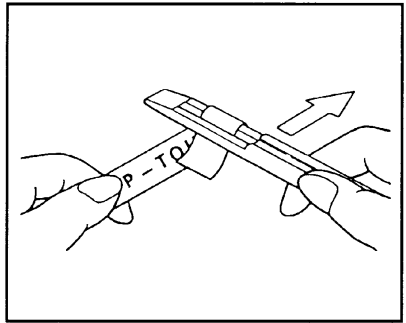
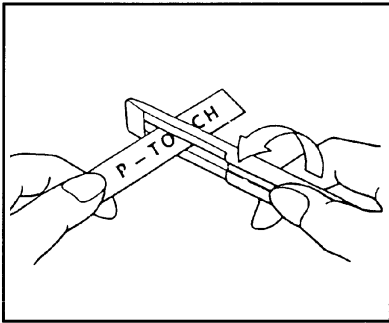

INSTANT LETTERING TAPE (RUB-ON CHARACTERS)

Instant lettering tapes act as rub-on character transfers. After creating a message, simply position the tape over a sheet of paper. By rubbing the instant lettering tape's non-printed side with the enclosed stick you can transfer the tape's contents directly onto the paper.

Note: Hold the tape tightly while rubbing and do not let it move.

IRON ON TRANSFER TAPE

TRANSFERRING:

You can transfer labels onto garments by pressing them with an iron.

- (1) After entering your message, print the label by pressing the PRINT key.
- (2) Press the garment with an iron to flatten it before transferring the message.
- (3) Place the label on the garment at the location where you wish to transfer the message.
- (4) Press over the label strongly with the iron set to cotton (150°C-180°C/300°F-350°F) for about 15 seconds.
- (5) Allow to cool for about 10 seconds, then remove the backing tape carefully (about 10 seconds after pressing).

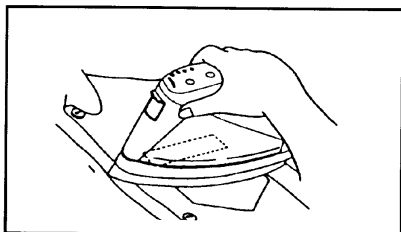
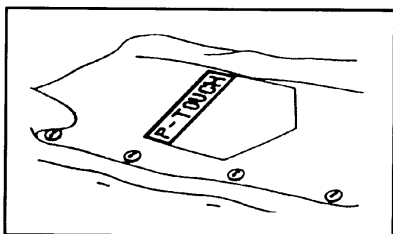

- Note:**
- *Transfers will be most successful on white garments made from 100% cotton with a plain (smooth) surface. You can also make transfers to garments made from 100% linen or cotton and polyester mix as long as they have a plain (smooth) surface.*
 - *Any cloth with a rough surface such as pile or denim, or a water-proof surface is not suitable for transferring labels because the label will not adhere to the surface properly.*
 - *It is necessary to transfer the label at high temperatures. Therefore, do not use on heat-sensitive materials such as nylon, acetate or other similar fibers.*

- *Do not move the iron while pressing. The label may move out of the required position.*
- *After the backing tape has been removed, the transferred label may appear glossy. Some white spots may appeared when the backing tape is removed. These can be fixed by ironing over the area of the label after placing a piece of cloth between the label and the iron.*
- *The label will have a slightly white background on colored cloth.*
- *Once applied, the transferred label cannot be removed so make all transfers with care.*

WASHING:

- You can wash garments with transferred labels over 20 times if the label has been transferred correctly. Normal detergents found in the home may be used.
- If the garment with the transferred label is placed in bleach for a length of time, discoloration may occur.
- Do not allow hard objects such as buckles or buttons to come into contact with the label during the wash.
- Do not dry clean garments which have had transfer labels applied.
- Dry cleaning chemicals may damage the transfer.

DRYING:

- You may drip dry garments with transfer labels either indoors or outdoors.
- Do not tumble dry at high heat settings. The transfers may come off and stick to other items of clothing.

PRESSING:

- Iron garments containing transfers using normal temperature settings.
- Make sure to place some cloth between the iron and the label when you iron over it to prevent the transferred label from sticking to the iron.

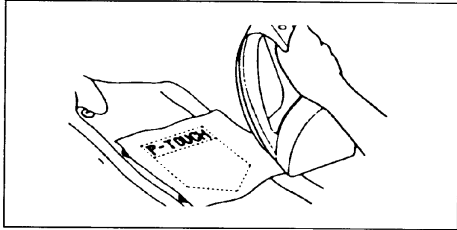

- The labels are non toxic and there are no materials regulated by law used in them. However, please maintain common sense precautions to prevent children from placing them in their mouths.
- Do not store the tape cartridge in direct sunlight or in an area of high humidity or dust.

PHRASE MEMORY OPERATION

PHRASE MEMORY

You can use the Phrase Memory function to store your most frequently used messages. Text stored in the Phrase Memory will not be deleted by the usual message clear operation (**CODE + CLEAR**).

You can easily recall your message from this Phrase Memory any time you want to work with it.

MEMORY SIZE

In the Phrase Memory you can store up to a total of 483 characters. These 483 characters can be divided into as many as nine areas, or messages. The maximum capacity for any single area is 55 characters.

Note: *When you remove or replace the batteries, do so in less than three minutes. Otherwise, any messages in the Phrase Memory are lost (unless an optional AC Adaptor is attached).*

STORING THE MESSAGE

To store the currently displayed message in the PHRASE MEMORY

- (1) Hold down the **CODE** key and press the **STORE** key.
- (2) The display will read:

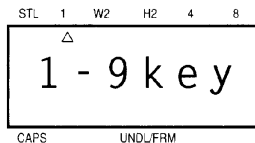

- (3) Press a key from 1 to 9 to select a storage area.
- (4) Your message is stored in the memory area you selected.

If the area you selected is already being used, an error message will briefly appear, and then the display will again ask you to choose an area. In that event, please select a different number from 1 to 9.

If all nine areas are being used, you must clear one of them before you can store your current message.

Also, when 483 characters are already stored in the Phrase Memory and you try to store more, the phrase "M. FULL", memory full, appears on the display. You must delete one of the memory areas before you can store your current message.

Example To store the message "J. SMITH" in the Phrase Memory:

- Make sure the message is in the working area (on the display).

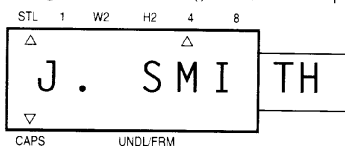

- Press **CODE** + **STORE** (8/7). The following guidance message appears on the display:

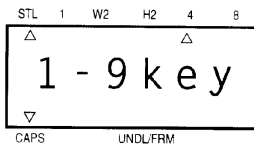

- Press a number key from 1 to 9.
This time, for example, press 1.

The message is stored in the Phrase Memory.

Note: Before you enter an area number you can cancel storage by press-

ing **CODE** + **STORE** (8/7) again.

RECALLING THE PHRASE MEMORY

To recall a message stored in one of the nine PHRASE MEMORY areas:

- (1) Holding down the **CODE** key, press the **RECALL** key.
- (2) The display will read:

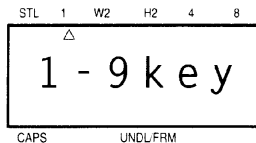

- (3) Select the number of the area you want to recall, and press it.
- (4) The key number and the beginning of the message appear on the display.
- (5) If you selected the wrong number, you can now press a new number key (1-9) to display the correct phrase.
- (6) When your desired message is on the screen press the **SET** key.
- (7) The Phrase Memory you select is recalled into the working area for use.

- Note:**
- The character size, print style, and underline/frame that are recalled are the same as those that were saved with the text.
 - When a message is recalled from the **Phrase Memory**, any message currently on the display is cleared.

Example To recall "J. SMITH" from the Phrase Memory:

- Press **CODE** + **RECALL** (* / 8). The following guidance message appears on the display:

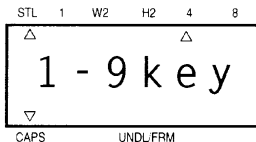

- Press 1, since you stored your message in area 1.

The stored message appears on the display, along with its area number.

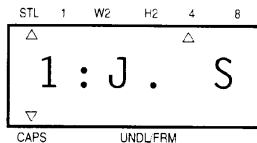

- Press **SET DENSITY**. The message is copied to the working area and remains on the display.

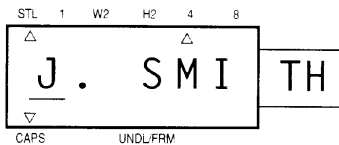

- You can see the current size setting on the display.
- You can check the style and underline/frame status by pressing the corresponding keys.
- Now you can print or edit the message.

Note: Before you press **SET DENSITY** you can cancel recall by pressing

CODE + **RECALL**
*
8 again.

DELETING THE PHRASE MEMORY

To delete an area of PHRASE MEMORY:

- (1) Hold down the **CODE** key and press the **M.DEL** key. The following message appears on the display:

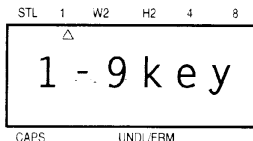

- (2) Select the number key (1-9) of the memory area you want to delete, and press it.
The key number and the beginning of the message appear on the display.
If you press a different number key (1-9), that area's message appears on the display.
- (3) When your desired message is on the screen, press the **SET** key.
- (4) The Phrase Memory area is cleared and the message previously in the working area reappears on the display.

Example To delete "J. SMITH" from the Phrase Memory:

- Press **CODE** + **M.DEL**. The following guidance appears on the display:

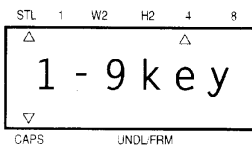

- Press 1.

The stored message appears on the display.

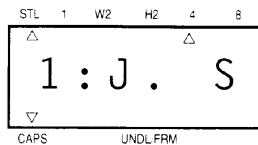

- Press . The message is deleted from the memory.

Note: Before you press you can cancel deletion by pressing

+ again.

Now you can use the cleared memory area "1" to store another message.

MESSAGE LIST

ERROR	Input error.
B.WEAK	The batteries are weak.
M.FULL	The working area is full (max: 55 characters) or the Phrase Memory is full (see page 42).
A-E key	See page 17.
NORMAL	See page 29.
O. LINE	
BOLD	
SHADOW	
VERTCL	
F : ON	See page 32.
F : OFF	
1-10?	See page 36.
1-9 key	See page 41, 43, 45.
NORMAL	See page 35.
+1	
+2	
-2	
-1	
M: ON	Mirror printing is ON.
M: OFF	Mirror printing is OFF.
NORMAL	Prints without underline/frame
U.LINE	Underlines characters
FRAME	Frames characters
DEMO	Printing demonstration (See page 7).
I: ON	Insert mode is ON.
I: OFF	Insert mode is OFF. (Overtpe mode)

TROUBLESHOOTING

Problem	What to Do
1. The display stays blank after you have turned on the machine.	<ul style="list-style-type: none">● Check the polarity of the batteries.● If the batteries are low, replace them.
2. The machine does not print, or the printed characters are blurred.	<ul style="list-style-type: none">● Check that the tape cassette has been inserted properly.● If the tape cassette is empty, replace it with a new one.● Make sure that the release lever has been closed properly.
3. The printed characters are not formed properly.	<ul style="list-style-type: none">● The batteries are probably weak. Replace them.● The print density is not appropriate. Adjust the print density.
4. The tape cannot be cut.	<ul style="list-style-type: none">● The cutting blade is probably dull. Replace the blade.
5. Silver tape appears.	<ul style="list-style-type: none">● You have reached the end of the tape. Replace it with a new tape.
6. The memory has cleared on its own.	<ul style="list-style-type: none">● The batteries are probably weak. Replace them.
7. An unprinted line appears on a label.	<ul style="list-style-type: none">● There may be some dust on the print head. Wipe the print head gently with a dry cotton swab.

- For technical and operational assistance call Customer Service at 1-901-373-6256 from 8:00 to 4:15 CST (Central Standard Time).
- For service of your Brother P-Touch machine call 1-901-373-8500

SPECIFICATIONS

Input Device:	49 keys (39 character keys and 10 function keys)
Print Speed:	12 cps (standard size)
Character Size:	Standard Size (1) Double Width (W2) Double Height (H2) Double Width & Double Height (4) 4 x Width & Double Height (8)
Internal Character Generator:	Standard Character Font Enlarged Character Font Font: LORI PS
Print Tape:	Pressure-sensitive adhesive-based 1/2", 12mm (W): 300", 7.7mm (L) 3/8", 9mm (W): 300", 7.7mm (L)
LCD:	7 x 5 dots 1line x 6 columns 1/8 duty
Power Supply:	6AA (SUM3/R6/LR6) batteries or optional AC Adaptor. The power automatically turns off when no key is pushed for five minutes.
Dimensions:	7.36" (W) x 4.78" (D) x 2.38" (PT-15) 7.36" (W) x 4.78" (D) x 2.52" (PT-12)
Weight:	1.1 lb (without batteries)
Memory Buffer Size:	55 characters
Phrase Memory Size:	483 characters maximum 9 available storage areas

ACCESSORIES

- **Supplies**

Obtain tape cassettes, AC Adaptors and tape cutters from your nearest authorized dealer. Brother cannot be held responsible for trouble caused by the use of unauthorized supplies.

- **Tape**

Each tape cassette is 25 feet long.

Stock No.	Description	QTY/ Package	Price
12mm (1/2") Tapes			
TC-10	Black Characters on Clear Adhesive	2	34.95
TC-11	Red Characters on Clear Adhesive	2	34.95
TC-12	Blue Characters on Clear Adhesive	2	34.95
TC-13	Gold Characters on Clear Adhesive	2	39.95
TC-20	Black Characters on White Adhesive	2	34.95
TC-21	Red Characters on White Adhesive	2	34.95
TC-22	Blue Characters on White Adhesive	2	34.95
TC-30	Red Characters on Clear Adhesive Blue Characters on Clear Adhesive Gold Characters on Clear Adhesive	3 (1 EACH)	49.95
TC-5001	Black Characters on Red Adhesive	1	17.95
TC-6001	Black Characters on Blue Adhesive	1	17.95
TC-7001	Black Characters on Yellow Adhesive	1	17.95
TC-8001	Black Characters on Green Adhesive	1	17.95
TC-33	Gold Characters on Black Adhesive	2	39.95
TC-B001	Black Characters on Fluorescent Orange Adhesive	1	24.95
TC-C001	Black Characters on Fluorescent Yellow Adhesive	1	24.95
TC-D001	Black Characters on Fluorescent Green Adhesive	1	24.95

Stock No.	Description	QTY/ Package	Price
TC-40	Red Characters on White Adhesive Blue Characters on White Adhesive Gold Characters on Black Adhesive	3 (1 EACH)	49.95
TC-50	Black Characters on Red Adhesive Black Characters on Blue Adhesive Black Characters on Yellow Adhesive Black Characters on Green Adhesive	4 (1 EACH)	71.95
TC-1004	Black Characters on Clear Adhesive	4	69.90
TC-2004	Black Characters on White Adhesive	4	69.90
9-mm Tapes (3/8")			
TC-34Z	White Characters on Black Adhesive	2	34.95
TC-14Z1	White Characters on Clear Adhesive	1	19.95
TC-20Z1	Black Characters on White Adhesive	1	17.95
TC-54Z1	White Characters on Red Adhesive	1	19.95
TC-64Z1	White Characters on Blue Adhesive	1	19.95
TC-74Z1	White Characters on Orange Adhesive	1	19.95
TC-84Z1	White Characters on Green Adhesive	1	19.95
TC-90Z1	Black Characters on Gold Adhesive	1	19.95
TC-A0Z1	Black Characters on Silver Adhesive	1	19.95
TC-60	White Characters on Red Adhesive White Characters on Blue Adhesive White Characters on Orange Adhesive White Characters on Green Adhesive	4 (1 EACH)	79.95
MAT Tapes (9mm) (3/8") (Recommended for use when photocopying; helps eliminate shadow lines.)			
TC-M0Z	Black Characters on Semi-Clear Adhesive	2	39.95

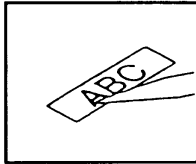
Stock No.	Description	QTY/ Package	Price
<p data-bbox="178 273 646 297">Instant Lettering Tape (Rub-on-characters - 1/2")</p> <p data-bbox="178 331 928 436">Instant lettering tapes act as rub-on character transfers. After creating a message, simply position the characters over a sheet of paper. By rubbing the instant lettering tape's non-printed side with the enclosed lettering stick, you can transfer the tape's contents directly onto the paper.</p> <p data-bbox="178 442 866 465">Caution: Hold tape very tight and do not move while rubbing the tape.</p> <div data-bbox="526 483 733 655" style="text-align: center;">  </div>			
TC-00	Black Characters	2	34.95
TC-01	Red Characters	2	34.95
TC-02	Blue Characters	2	34.95
Iron On Transfer Tape (1/2")			
TC-Y001	Black Characters	1	19.95
TC-Y101	Red Characters	1	19.95
TC-Y201	Blue Characters	1	19.95
Others			
AD-20	AC Adaptor for PT-6/8/10/GOLD/170K/ 150/12/15	1	19.95
AD-30	AC Adaptor for PT-6/8/10/GOLD/170K/ 150/12/15/20/25	1	21.95
TC-8	Replacement Tape Cutter	1	9.95

MANUAL DE INSTRUCCIONES

INTRODUCCION

El nuevo P-Touch le ayudará diseñar e imprimir etiquetas para cualquier aplicación. Extremadamente versátil, puede crear caracteres en múltiples tamaños y estilos.

Ya no tendrá por que preocuparse por las tareas que siempre exijan una impresión profesional. La calidad y prestaciones del P-Touch lo convierten en un instrumento versátil.

Aunque el P-Touch es de fácil utilización, le sugerimos que lea este manual con atención antes de empezar a utilizarlo. Conserve este manual a su alcance por si tuviera necesidad de realizar alguna consulta.

¡Buena suerte! Le deseamos que le resulte agradable la utilización del P-Touch.

AVISODE LA FCC

Este equipo ha sido probado y se ha determinado que cumple los límites para los dispositivos digitales de la Clase B de acuerdo con la Parte 15 de las Normas de la FCC. Estos límites han sido diseñados para ofrecer una protección razonable contra las interferencias perjudiciales en una instalación residencial. Este equipo genera, emplea, y puede radiar energía de radiofrecuencia y, si no se instala de acuerdo con las instrucciones, puede causar interferencias perjudiciales en las radiocomunicaciones. Sin embargo, no se garantiza que las interferencias no se produzcan en una instalación particular. Si este equipo causa interferencias en la recepción de radio o televisión, lo que podrá determinarse desconectando y volviendo a conectar su alimentación, el usuario deberá corregir el problema tomando una o más de las medidas siguientes:

- Reorientación o reubicación de la antena receptora
- Aumento de la separación entre el equipo y el receptor
- Conexión del equipo a una toma de la red de circuito diferente al que esté conectado el receptor
- Consulta al proveedor o a un técnico de radio/televisión experimentado

Los números de patente y los de publicación de patentes relacionados con este producto son los siguientes:

USP4839742	USP4983058	EP315369 (Pending)	GB2223740
USP4922063	USP5009530	EP322918	
USP4927278	USP5069557	EP322919	
USP4966476	USP5120147		
USP4976558			

CONTENIDO

PRECAUCIONES	2
INSERCIÓN DE LA CINTA	3
INSERCIÓN DE LAS PILAS	4
REEMPLAZO DEL CORTADOR	5
JUEGO DE SÍMBOLOS	6
FUNCIONES DE EDICIÓN DE TEXTO	7
TAMAÑO DE CARACTERES	8
ESTILOS	9
SUBRAYADO Y EN RECUADRO	9
MODOS DE IMPRESIÓN	10
FUNCIONES DE LA MEMORIA DE FRASES	11
CINTAS DISPONIBLES	12

PRECAUCIONES

Situación:

- No exponga la máquina a altas temperaturas ni alta humedad.
- No emplee la máquina en lugares polvorientos.
- No ponga nada encima ni dentro de la máquina.

Alimentación:

- Emplee sólo el adaptador de CA diseñado exclusivamente para la **P-touch**.
- Extraiga las pilas y desconecte el adaptador de CA si no tiene la intención de utilizar la máquina durante períodos prolongados de tiempo.

Precaución: Cuando se ha desconectado la alimentación y se extraen las pilas, el contenido de la memoria quedará protegido durante unos 3 minutos. Después de este tiempo, los mensajes del área de trabajo y de la memoria de frases se perderán. Cuando se cambien las pilas, asegúrese de que esté conectado el adaptador de CA.

Limpieza:

- No limpie la máquina con alcohol ni otros solventes. Emplee sólo un paño suave y seco.
- No toque el mecanismo del cabezal de impresión. Si lo hace, límpielo inmediatamente con un palillo con cabeza de algodón para evitar daños permanentes en la P-touch.

Cintas:

- No intente nunca cortar la cinta durante la impresión ni durante la alimentación de cinta.
- No tire nunca de la cinta porque podría dañar el cartucho.
- No guarde las cintas bajo la luz del sol, ni en lugares húmedos o polvorientos.

Planche las cintas de transferencia:

- Planche en el ajuste "cotton" (algodón) durante unos 15 segundos.
- Deje que se enfríe la cinta y la tecla durante unos 10 segundos antes de sacar la cinta auxiliar.
- No utilice nilón ni otras telas sensibles al calor. No limpie en seco ni seque en secadora.
- Proteja la etiqueta transferida con un paño cuando se planche.

INSERCIÓN DE LA CINTA

- Desconecte la alimentación.
- Extraiga la cubierta y el cartucho viejo
- Extraiga la placa de cierre del nuevo cartucho de cinta y, con el dedo, de le dos vueltas completas a la cinta en la dirección de la flecha.
- Inserte el nuevo cartucho de cinta, instale la cubierta y presione la palanca amarilla.

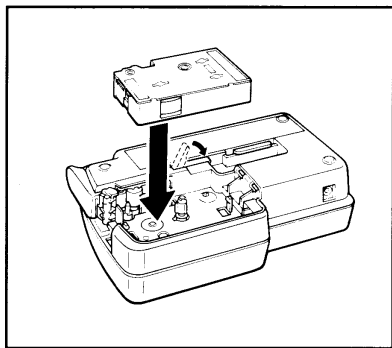
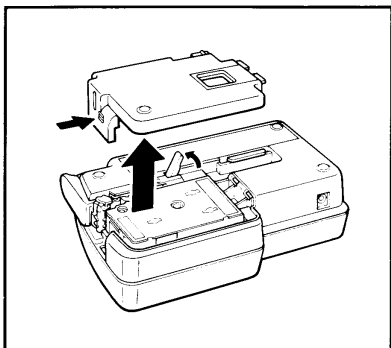

INSERCIÓN DE LAS PILAS

- No mezcle pilas usadas con pilas nuevas. Emplee sólo pilas del tipo C, preferiblemente alcalinas.

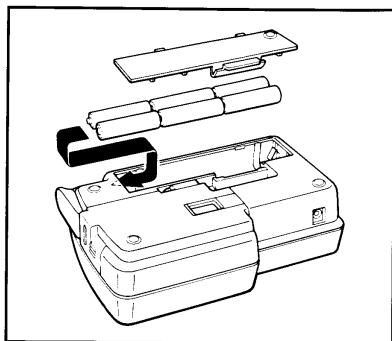
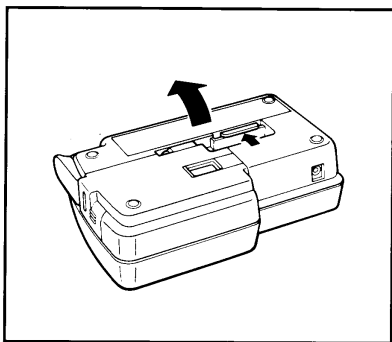

REEMPLAZO DEL CORTADOR

- Extraiga el cortador de la cinta usado (aprox. 3000 cortes) con el lado vacío de la unidad de reemplazo
- Alinee los dientes del nuevo cortador con los dientes del engranaje. Presione la unidad de reemplazo para instalar el nuevo cortador.

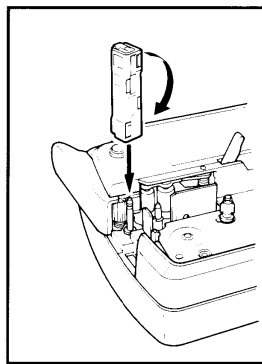
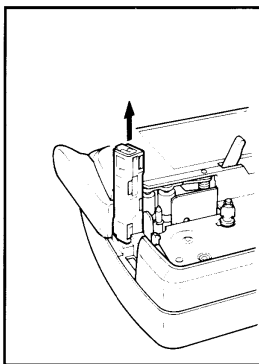
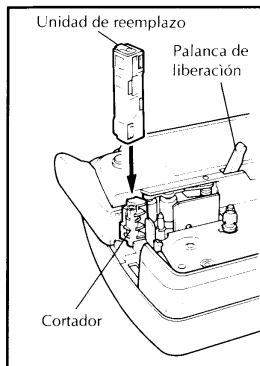

JUEGO DE SÍMBOLOS

A	Ü	Æ	æ	ª	º	
B	×	÷	[]	+	=
C	§	²	³	$\frac{1}{2}$	•	◦
D	↑	↓	→	←		
E	™	®	©	★	♥	☺

CODE + **ALT SYMBOL** para introducir el modo de símbolos.

Presione una tecla de letra **A** a **E** para seleccionar un grupo de símbolos.

Seleccione el símbolo con **TOP** o **RELOC** y presione **SET DENSITY**.

FUNCIONES DE EDICIÓN DE TEXTO

El visualizador muestra 6 caracteres, pero un mensaje puede tener hasta 55 caracteres.

◀ y ▶: Mueve el cursor un espacio

CLEAR
DEL : Borra un carácter hacia la izquierda

WORD OUT
CODE + $\begin{matrix} \uparrow \\ 0 \end{matrix}$: Borra una palabra hacia la izquierda

CLEAR
CODE + DEL : Borra el mensaje de la memoria y el visualizador

INSERT
CODE + $\begin{matrix} \uparrow \\ 6 \end{matrix}$: Interruptor entre el modo de sobreescritura y el de inserción.

TAMAÑO DE CARACTERES

1 - SIN INDICADOR – Tamaño estándar

J. SMITH

W2 - Doble ancho

J. SMITH

H2 - Doble alto

J. SMITH

4 - Doble ancho & Doble alto

J. SMITH

8 - 4 x Ancho & Doble alto

J. SMITH

El número entre paréntesis es el ajuste del tamaño de los caracteres.

ESTILOS

1 - Normal

J. SMITH

2 - Outline (O.LINE)

J. SMITH

3 - Negrita (Bold)

J. SMITH

4 - Sombra (SHADOW)

J. SMITH

Los ajustes son: NORM., BOLD, OUTL. y SHAD.

SUBRAYADO Y EN RECUADRO

Normal

Subrayado

Recuadro

Los símbolos de visualización para el modo de subrayado son:

T : Normal

I : Subrayado

□ : Recuadro

MODOS DE IMPRESIÓN

CODE + $\overset{\text{TAPE}}{\begin{matrix} \text{On} \\ 3 \end{matrix}}$: Visualización de los ajustes e interruptor entre AUTO y los ajustes de alimentación de cinta.

CODE + $\overset{\text{REPEAT}}{\begin{matrix} S \\ 4 \end{matrix}}$: Ajuste del número de copias a imprimirse. Ajuste del número de copias a imprimirse.

CODE + PRINT MIRROR : Impresión de imagen de espejo (legible desde el lado engomado).

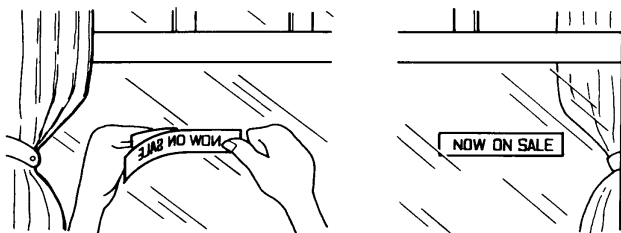

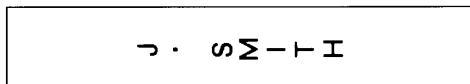

CODE + $\overset{\text{STYLE}}{\begin{matrix} @ \\ 2 \end{matrix}}$: Impresión vertical (los juegos de caracteres grandes y Undl/Box no están disponibles en este modo)







PRINT MIRROR : Impresión de etiqueta.

FUNCIONES DE LA MEMORIA DE FRASES



En la Memoria de Frase puede almacenar hasta 483 caracteres on total; Estos 483 caracteres puede dividirlos en nueve áreas. La capacidad máxima de un área es de 55 caracteres.

 +  : Almacenamiento del mensaje actual en la memoria de frases.

 +  : Llamada de un mensaje de la memoria de frases.

 +  : Borrado de un mensaje de la memoria de frases.

 +  + conexión de la alimentación: Borrado de todos los mensajes de la memoria de frases

 y  : Visión del mensaje seleccionado.

 : Cancelación de operaciones de mensajes y retorno al modo de edición.

CINTAS DISPONIBLES

No. de Stock	Descripción	Cantidad /Paquete	Precio
Cintas de 12mm (1/2")			
TC-10	Adhesiva con caracteres en negro sobre claro	2	34,95
TC-11	Adhesiva con caracteres en rojo sobre claro	2	34,95
TC-12	Adhesiva con caracteres en azul sobre claro	2	34,95
TC-13	Adhesiva con caracteres en dorado sobre claro	2	39,95
TC-20	Adhesiva con caracteres en negro sobre blanco	2	34,95
TC-21	Adhesiva con caracteres en rojo sobre blanco	2	34,95
TC-22	Adhesiva con caracteres en azul sobre blanco	2	34,95
TC-30	Adhesiva con caracteres en rojo sobre claro Adhesiva con caracteres en azul sobre claro Adhesiva con caracteres en dorado sobre claro	3 (1 DE CADA)	49,95
TC-5001	Adhesiva con caracteres en negro sobre rojo	1	17,95
TC-6001	Adhesiva con caracteres en negro sobre azul	1	17,95
TC-7001	Adhesiva con caracteres en negro sobre amarillo	1	17,95
TC-8001	Adhesiva con caracteres en negro sobre verde	1	17,95
TC-33	Adhesiva con caracteres en dorado sobre negro	2	39,95
TC-B001	Adhesiva con caracteres en negro sobre naranja fluorescente	1	24,95
TC-C001	Adhesiva con caracteres en negro sobre amarillo fluorescente	1	24,95
TC-D001	Adhesiva con caracteres en negro sobre verde fluorescente	1	24,95
TC-40	Adhesiva con caracteres en rojo sobre blanco Adhesiva con caracteres en azul sobre blanco Adhesiva con caracteres en dorado sobre negro	3 (1 DE CADA)	49,95
TC-50	Adhesiva con caracteres en negro sobre rojo Adhesiva con caracteres en negro sobre azul Adhesiva con caracteres en negro sobre amarillo Adhesiva con caracteres en negro sobre verde	4 (1 DE CADA)	71,95
TC-1004	Adhesiva con caracteres en negro sobre claro	4	69,90

No. de Stock	Descripción	Cantidad /Paquete	Precio
TC-2004	Adhesiva con caracteres en negro sobre blanco	4	69,90
Cintas de 9mm (3/8")			
TC-34Z	Adhesiva con caracteres en blanco sobre negro	2	34,95
TC-14Z1	Adhesiva con caracteres en blanco sobre claro	1	19,95
TC-20Z1	Adhesiva con caracteres en negro sobre blanco	1	17,95
TC-54Z1	Adhesiva con caracteres en blanco sobre rojo	1	19,95
TC-64Z1	Adhesiva con caracteres en blanco sobre azul	1	19,95
TC-74Z1	Adhesiva con caracteres en blanco sobre naranja	1	19,95
TC-84Z1	Adhesiva con caracteres en blanco sobre verde	1	19,95
TC-90Z1	Adhesiva con caracteres en negro sobre dorado	1	19,95
TC-A0Z1	Adhesiva con caracteres en negro sobre plato	1	19,95
TC-60	Adhesiva con caracteres en blanco sobre rojo Adhesiva con caracteres en blanco sobre azul Adhesiva con caracteres en blanco sobre naranja Adhesiva con caracteres en blanco sobre verde	4 (1 DE CADA)	79,95
Cintas MAT (9mm) (Recomendadas para utilizarse para fotocopiar; ayudan a eliminar las líneas de sombra.)			
TC-M0Z	Adhesiva con caracteres en negro sobre semi-claro	2	39,95
TC-00	Caracteres en negro	2	34,95
TC-01	Caracteres en rojo	2	34,95
TC-02	Caracteres en azul	2	34,95
Plancha la cinta de transferencia (1/2")			
TC-Y001	Caracteres en negro	1	19,95
TC-Y101	Caracteres en rojo	1	19,95
TC-Y201	Caracteres en azul	1	19,95
Otros			
AD-20	Adaptador de CA para PT-6/8/10/GOLD/170K/150/12/15	1	19,95
AD-30	Adaptador de CA para PT-6/8/10/GOLD/170K/150/12/15/20/25	1	21,95
TC-8	Contador de cinta	1	9,95

Brother P-Touch Telephone Contact Guide

- For technical and operational assistance call Customer Service at 1-901-373-6256 from 8:00 to 4:15 CST (Central Standard Time).
- For service of your Brother P-Touch call 1-901-373-8500.
- To order brochures on other Brother products call 1-800-284-4357.
- To order ribbons and accessories:
 - 1) Contact your local Brother authorized dealer to see whether they carry the ribbon or accessory that you require.
 - 2) To use Visa or Master Card call Toll FREE 1-800-284-4357, or fax your order to Brother at 1-901-373-6213 anytime.
 - 3) For questions on which ribbons or accessories fit your machine call 1-800-284-4357 from 9:00 to 4:30 EST (Eastern Standard Time).
 - 4) To order by mail or pay by check, please fill out the accessory order form and mail along with payment to:

Customer Service
Brother International Corporation
P.O. Box 341332
Bartlett, TN 38184-1332

NOTE

• Please read this notice carefully before starting

To insert a new tape cartridge

• FULL UP THE RELEASE LEVER

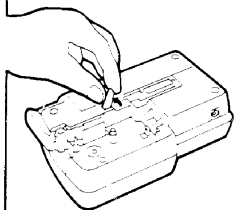

• REMOVE THE STOPPER

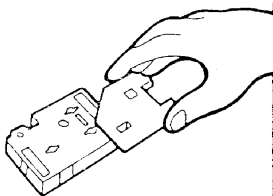

• USE YOUR FINGER TO WIND TAPE TWO FULL TIMES

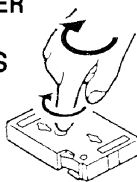

Cutting Tape

• DO NOT PULL TAPE TO ADVANCE

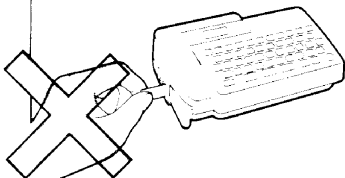

• TO CUT TAPE, USE THE BUILT-IN CUTTER LEVER. UNDER NO CIRCUMSTANCES ATTEMPT TO CUT THE TAPE WHILE PRINTING OR FEEDING.

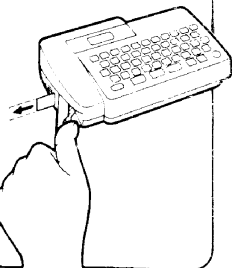

AC Adaptor connection

• USE AC ADAPTOR DESIGNED EXCLUSIVELY

