

Operation Manual

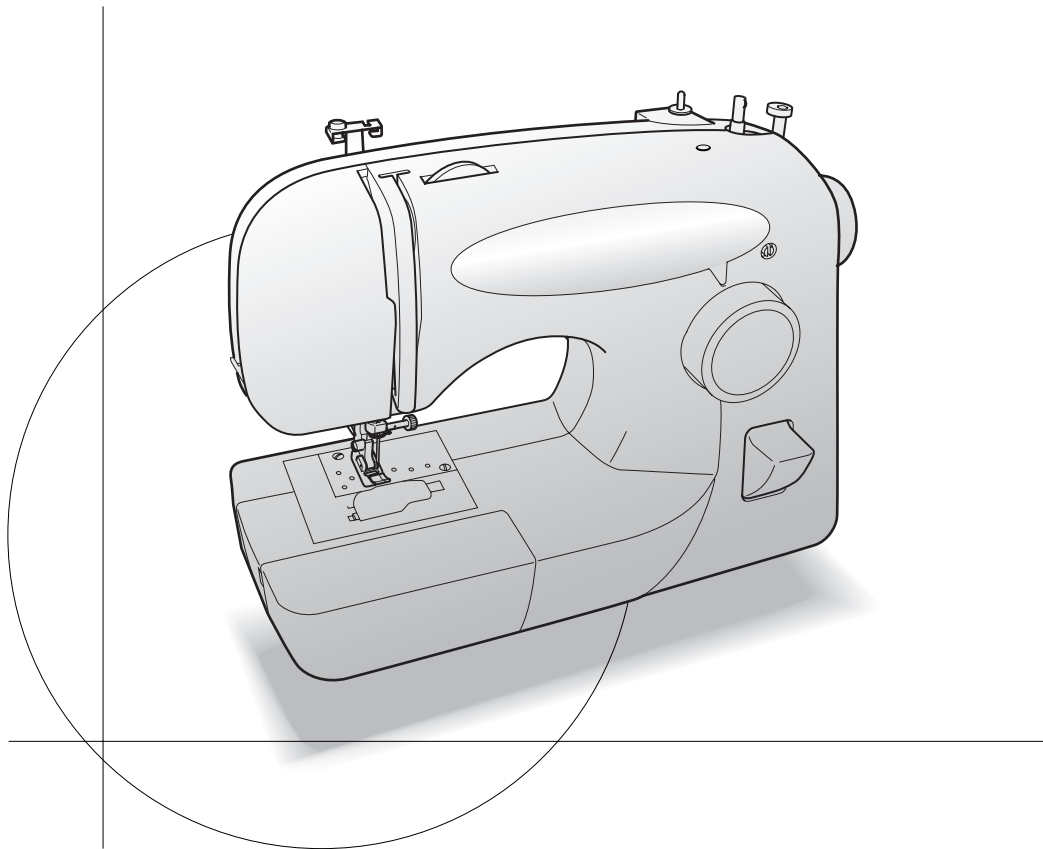

brother®

IMPORTANT SAFETY INSTRUCTIONS

When using this machine, basic safety precautions should always be taken, including the following:

Read all instructions before using.

DANGER - To reduce the risk of electric shock:

1. The machine should never be left unattended while plugged in. Always unplug the machine from the electrical outlet immediately after using and before cleaning.
2. Always unplug the machine before you change the light bulb.
Replace the bulb with same type rated 15 watts.

WARNING - To reduce the risk of burns, fire, electric shock, or injury to persons:

1. Do not allow this machine to be used as a toy. Close attention is necessary when the machine is used by or near children.
2. Use this machine only for its intended use as described in this manual. Use only accessories recommended by the manufacturer as contained in this manual.
3. Never operate this machine if it has a damaged cord or plug, if it is not working properly, if it has been dropped or damaged, or dropped into water. Return the machine to the nearest authorized dealer or service center for examination, repair, electrical or mechanical adjustment.
4. Never operate the machine with any air openings blocked. Keep ventilation openings of the machine and foot control free from the accumulation of lint, dust, and loose cloth.
5. Never drop or insert any object into any opening.
6. Do not use outdoors.
7. Do not operate where aerosol (spray) products are being used or where oxygen is being administered.
8. To disconnect, turn the main switch to the symbol "O" position which represents off, then remove plug from outlet.
9. Do not unplug by pulling on the cord. To unplug, grasp the plug, not the cord.
10. Keep fingers away from all moving parts. Special care is required around the machine needle.
11. Always use the proper needle plate. The wrong plate can cause the needle to break.
12. Do not use bent needles.
13. Do not pull or push fabric while stitching. It may deflect the needle causing it to break.
14. Switch the machine to the symbol "O" position to turn it off when making any adjustments in the needle area, such as threading needle, changing needle, threading bobbin, or changing presser foot, and the like.
15. Always unplug the machine from the electrical outlet when removing covers, lubricating, or when making any other user servicing adjustments mentioned in the instruction manual.
16. This sewing machine is not intended for use by young children or infirm persons without supervision.
17. Young children should be supervised to ensure that they do not play with this machine.

SAVE THESE INSTRUCTIONS
This machine is intended for household use.

FOR USERS IN THE UK, EIRE, MALTA AND CYPRUS ONLY

If this machine is fitted with a three-pin non-rewireable BS plug then please read the following.

IMPORTANT (in the United Kingdom)

Main supply (AC 230/240V~, 50Hz)

DO NOT cut off the main plug from equipment. If the plug fitted is not suitable for the power point in your home or the cable is too short to reach a power point, then obtain an appropriate safety approved extension lead or consult your dealer.

BE SURE to replace the fuse only with an identical approved type, as originally fitted and to replace the fuse cover.

If none the less the main plug is cut off be sure to remove the fuse and dispose of the plug immediately, to avoid a possible shock hazard by inadvertent connection to the main supply.

IMPORTANT (in the other countries)

If the available socket outlet is not suitable for the plug supplied with this equipment, it should be cut off and an appropriate three pin plug fitted. With alternative plugs an approved fuse must be fitted in the plug.

NOTE: The plug severed from the main leads must be destroyed as a plug with bared flexible cords is hazardous if engaged in a live socket outlet. In the event of replacing the plug fuse, use a fuse approved by ASTA to BS 1362, i.e. carrying the  mark, rating as marked on plug.

Always replace the fuse cover. Never use plugs with the fuse cover omitted.

WARNING: DO NOT CONNECT EITHER WIRE TO THE EARTH TERMINAL WHICH IS MARKED WITH THE LETTER 'E', BY THE EARTH SYMBOL  OR COLORED GREEN OR GREEN AND YELLOW.

The wires in this main lead are colored in accordance with the following code:

Blue	Neutral
Brown	Live

As the colors of the wiring in the main lead of this appliance may not correspond with the colored markings identifying the terminals in your plug, proceed as follows:

The wire which is colored blue must be connected to the terminal which is marked with the letter 'N' or colored black or blue.

The wire which is colored brown must be connected to the terminal which is marked with the letter 'L' or colored red or brown.

UNPACKING INSTRUCTIONS

Keep the carton and packing materials. You may have to take or send the machine to be repaired. If you do not pack it properly, or do not use the right packing material, the machine could be damaged. Please follow the diagram below to unpack the machine.

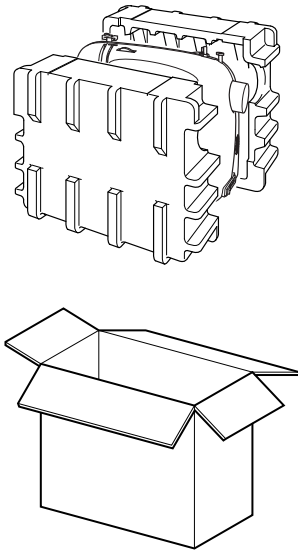

IMPORTANT

- This packing material is designed to prevent damage. Save this packing material if you need to take or send this machine to be repaired.

PLEASE READ THESE INSTRUCTIONS BEFORE YOU USE THE MACHINE.

To use the machine safely

1. Make sure you watch the needle carefully while you are sewing. Do not touch the balance wheel, thread take-up lever, needle, or other moving parts.
2. Remember to turn off the power switch and unplug the cord:
 - when you have stopped using the machine;
 - when you are replacing or removing the needle or any other part;
 - if there is a power failure while you are using the machine;
 - if you are checking or cleaning the machine.
3. Do not store anything on the foot controller.

To give your machine a longer life

1. Do not store this machine in direct sunlight or in high humidity conditions. Do not use or store the machine near a heater, iron, halogen lamp or other hot objects.
2. Use only mild soaps or detergents to clean the case. Benzene, thinner, and scouring powders can damage the case and machine, and should never be used.
3. Do not drop or hit the machine.
4. Always check the operation manual before you replace or fit the presser feet, the needle, or any other parts to make sure you fit them correctly.

To repair or adjust the machine

If the machine breaks down, or you need to adjust it, first follow the troubleshooting table in the Appendix of this operation manual to inspect and adjust the machine yourself. If the problem is still there, please consult your local authorized dealer.

CONTENTS

IMPORTANT SAFETY INSTRUCTIONS	1
UNPACKING INSTRUCTIONS	3
CONTENTS	5

1. KNOWING YOUR SEWING MACHINE7

THE MAIN PARTS	8
ACCESSORIES	9
Optional Accessories	9
USING YOUR SEWING MACHINE	10
Connecting Plugs	10
Main Power and Sewing Light Switch	11
Foot Controller	11
Checking the Needle	11
Replacing the Needle	12
Changing the Presser Foot	13
Flat-Bed Attachment	14
THE CONTROLS	15
Pattern Selection Dial	15
Patterns and Stitch Names	16
Reverse Sewing Lever	17
Using a Free-arm Style	17
THREADING THE MACHINE	18
Winding the Bobbin	18
Lower Threading	20
Lower Threading (For One-touch lower threading)	21
Upper Threading	23
Using the Needle Threader (Models equipped with a needle threader)	24
Drawing up the lower thread	26
Sewing with a Twin Needle	27
Tension of the Thread	28
FABRIC, THREAD, AND NEEDLE COMBINATIONS	29

2. STRAIGHT AND ZIGZAG STITCHING31

Please Read Before Sewing	32
Straight Stitching	32
Zigzag Stitching	34

3. BUILT-IN STITCHES35

Blind Hem Stitching	36
Elastic Stitching	36
Overedge Stitching	37

4. SEWING BUTTONHOLES AND BUTTONS39

Making a Buttonhole	40
Adjusting Buttonholes	41
Sewing Buttons	42

5. USING ATTACHMENTS AND APPLICATIONS43

Zipper Insertion 44
Gathering 45
Darning 45
Appliqués 46
Monogramming and Embroidering 47

OPTIONAL ACCESSORIES 49

Using the Walking Foot 49
Using the Quilting Foot 50
Using the 1/4-Inch Quilting Foot 51

6. APPENDIX53

MAINTENANCE 54

Changing the Light Bulb 54
Cleaning 55
Troubleshooting 57
Repacking the Machine 60

INDEX 61

1

KNOWING YOUR SEWING MACHINE

THE MAIN PARTS

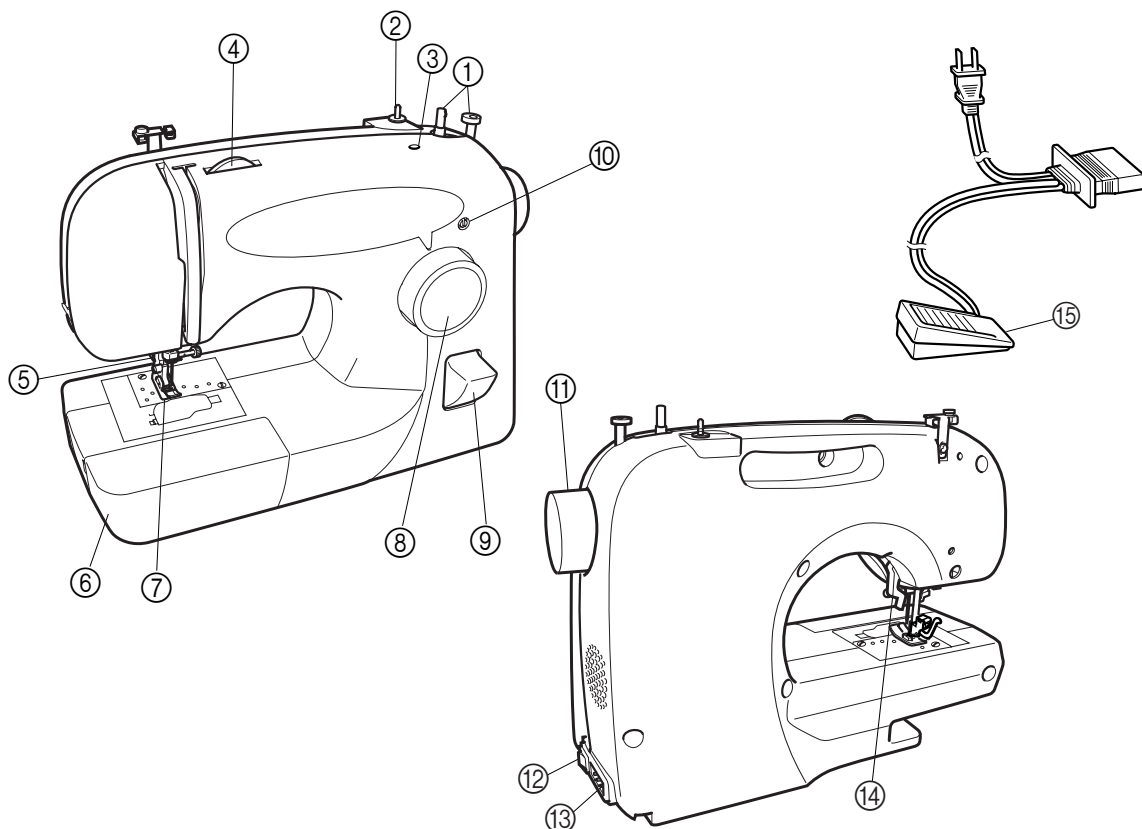

① **Bobbin winder (Page 18)**

This winds the thread onto the bobbin, which you use for the lower thread.

② **Spool pin (Page 18, 23)**

③ **Hole for vertical spool pin (Page 27)**

This holds a second spool of thread, if you want to sew with two needles.

④ **Upper tension-control dial (Page 28)**

This controls the tension of the upper thread.

⑤ **Needle threader (Page 24)**

This is only available on certain models.

⑥ **Flat bed attachment with accessory compartment (Page 14, 17)**

⑦ **Zigzag presser foot (Page 8, 13)**

⑧ **Pattern selection dial (Page 15)**

You can turn this in either direction to choose the stitch you want.

⑨ **Reverse-sewing lever (Page 17)**

You can push this to stitch in the reverse direction.

⑩ **Buttonhole fine-adjustment screw (Page 34, 41)**

⑪ **Balance wheel**

⑫ **Main power and sewing light switch (Page 11)**

You can turn the main power and sewing light switch on and off.

⑬ **Foot controller jack (Page 10)**

Plug in the foot controller plug and connect the machine to the power supply.

⑭ **Presser foot lever (Page 23)**

⑮ **Foot controller (Page 11)**

You can use this to control the sewing speed, and to start and stop sewing.

Parts Code for Zigzag Presser Foot: XC4901-051

Foot Controller: Model N

Parts Code: XC5458-021 (110/120V Area)

XC5454-021 (220/240V Area)

XC5462-021 (U.K.)

XC5493-021 (Australia, New Zealand)

XC5494-021 (Argentina)

XC5495-021 (110/220V Dual Area)

ACCESSORIES

The following accessories are stored in the flat-bed attachment. We have designed these accessories to help you carry out most sewing tasks.

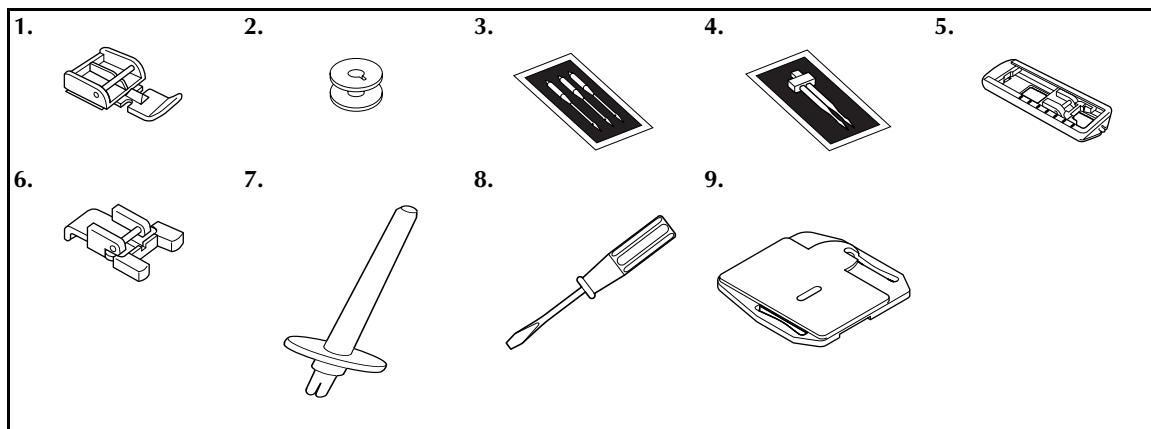

No.	Part Name	Part Code		No.	Part Name	Part Code	
		USA	Others			USA	Others
1	Zipper foot (1 pc.)	X59370-051		5	Buttonhole Foot (1 pc.)	X59369-251	
2	Bobbin (3 pcs.)	SA156	SFB (XA5539-151)	6	Button Sewing Foot (1 pc.)	X59375-051	
3	Needle Pack (Regular Single Needle HAX130 (3 pcs.))	129583-001		7	Extra Spool Pin (1 pc.)	130920-021	
4	Twin Needle (1 pc.)	X57521-001		8	Screwdriver (1 pc.)	X55467-051	
				9	Darning Plate (1pc.)	XC6063-021	

Optional Accessories

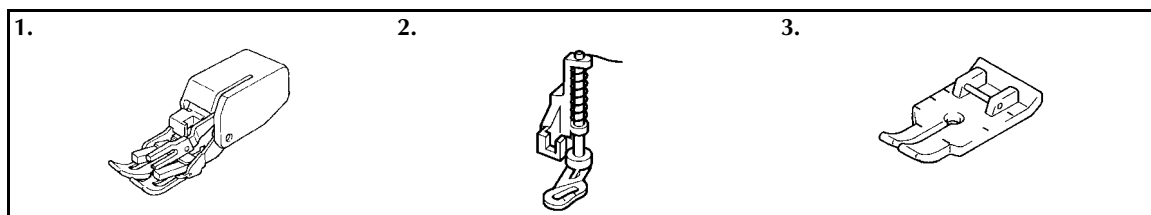

No.	Part Name	Part Code	
		U.S.A.	Others
1	Walking Foot	SA107	F034N (XC2165-002)
2	Quilting Foot	SA129	F005N (XC1948-002)
3	1/4-Inch Quilting Foot	SA125	F001N (XC1944-002)



Note

- The accessories that come with your machine depend on which model you have bought.

USING YOUR SEWING MACHINE

⚠ WARNING

- Use only regular mains household electricity for the power source. Using other power sources may result in fire, electric shock, or damage to the machine.
- Turn off the main power and remove the plug in the following circumstances:
 - When you are away from the machine
 - After using the machine
 - When the power fails during use
 - When the machine does not operate correctly due to a bad connection or a disconnection
 - During electrical storms

⚠ CAUTION

- Do not use extension cords or multi-plug adapters with many other appliances plugged in to them. Fire or electric shock may result.
- Do not touch the plug with wet hands. Electric shock may result.
- When unplugging the machine, always turn off the main power first. Always grasp the plug to remove it from the outlet. Pulling on the cord may damage the cord, or lead to fire or electric shock.
- Do not allow the power cord to be cut, damaged, modified, forcefully bent, pulled, twisted, or bundled. Do not place heavy objects on the cord. Do not subject the cord to heat. These things may damage the cord and cause fire or electric shock. If the cord or plug is damaged, take the machine to your authorized dealer for repairs before continuing use.
- Unplug the power cord if the machine is not to be used for a long period of time. Otherwise a fire may result.

Connecting Plugs

- 1 Connect the power cord plug into the machine.
- 2 Connect the power supply plug into a wall outlet.

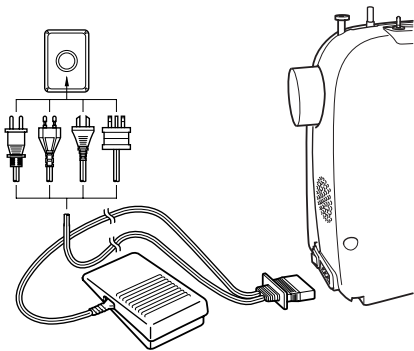

⚡ Note

- When leaving the machine unattended, the main switch of the machine should be switched off or the plug must be removed from the socket-outlet.
- When servicing the machine, or when removing covers or changing bulbs, the machine must be unplugged.

(For U.S.A. only)

- This appliance has a polarized plug (one blade wider than the other). To reduce the risk of electric shock, this plug is intended to fit in a polarized outlet only one way. If the plug does not fit fully in the outlet, reverse the plug. If it still does not fit, contact a qualified electrician to install the proper outlet. Do not modify the plug in any way.

Main Power and Sewing Light Switch

This switch turns the mains power and sewing light on or off.

- 1 Turn on (toward the 'I' mark)
- 2 Turn off (toward the 'O' mark)

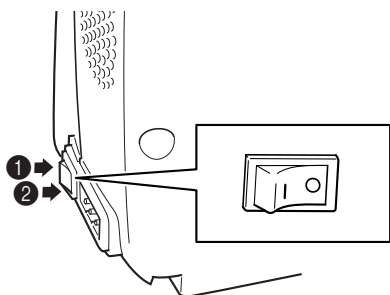

Foot Controller

When you press the foot controller down lightly, the machine will run at a low speed. When you press harder, the machine's speed will increase. When you take your foot off the foot controller, the machine will stop. You should make sure that nothing is placed on the foot controller when the machine is not in use.

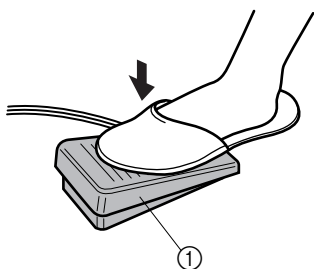

① Foot controller

CAUTION

- Do not allow pieces of cloth and dust to build up on the foot controller. Doing so could cause a fire or an electric shock.



Note

(For U.S.A. only)

- Foot Controller: Model N
This foot controller can be used for Model XL-2121, XL-2125, XL-2230.

Checking the Needle

The sewing needle must always be straight and sharp for smooth sewing.

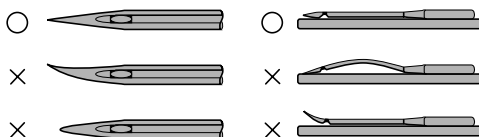

■ To Check the Needle Correctly:

Put the flat side of the needle on a flat surface. Check the needle from the top and the sides. Dispose of any bent needles safely.

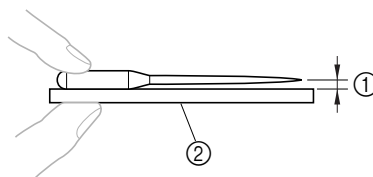

- ① Parallel space
- ② Level surface (bobbin cover, glass, etc.)

Replacing the Needle

CAUTION

- Turn the main power switch off before you change the needle. If you leave the main power on and step on the foot controller, the machine will start and you may be injured.
- Only use sewing-machine needles for home use. Other needles may bend or break and cause injury.
- Never sew with a bent needle. A bent needle will easily break and cause injury.

- 1 Remove the power supply plug from the outlet.
- 2 Raise the needle bar to its highest position by turning the balance wheel counterclockwise.
- 3 Lower the presser foot lever.

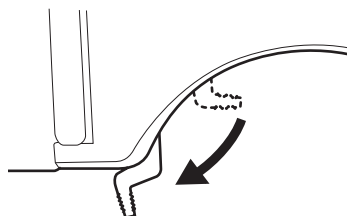

① Presser foot lever

- 4 Hold the needle with your left hand, and then use a screwdriver to turn the needle clamp screw counterclockwise to remove the needle.

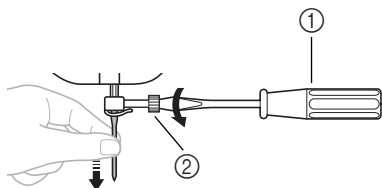

① Screwdriver
② Needle clamp screw

- Do not use a lot of force when loosening or tightening the needle clamp screw, otherwise certain parts of the sewing machine may be damaged.

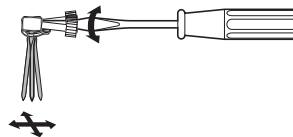

- 5 With the flat side of the needle toward the back of the machine, put the needle in until it touches the needle stopper.

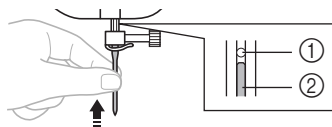

① Needle stopper
② Needle

- 6 While holding the needle with your left hand, use the screwdriver to tighten the needle clamp by turning it clockwise.

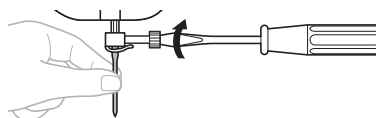

Put the twin needle in the same way.

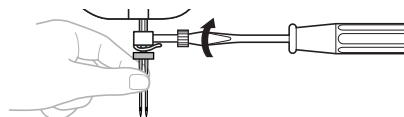

CAUTION

- Make sure you push in the needle until it touches the stopper, and securely tighten the needle clamp screw with a screwdriver. If the needle is not in fully, or if the needle clamp screw is loose, the needle may break or the machine may be damaged.

Changing the Presser Foot

CAUTION

- Always turn off the power before you change the presser foot. If you leave the power on and step on the controller, the machine will start and you may be injured.
- Always use the correct presser foot for the stitch pattern you have chosen. If you use the wrong presser foot, the needle may strike the presser foot and bend or break, and may cause injury.
- Only use presser feet that have been designed to be used with this machine. Using other any presser feet may cause an accident or injury.

You will have to change the presser foot depending on what you want to sew and how.

■ Snap-On Type

- 1** Raise the needle to its highest position by turning the balance wheel toward you (counterclockwise) and raise the presser foot lever.
- 2** Release the foot by raising the lever at the back of the holder.

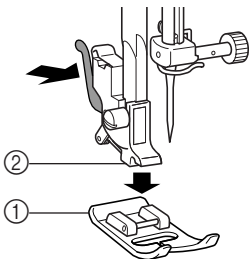

- ① Presser Foot
- ② Shank

- 3** Put a different presser foot on the needle plate so that the bar on the presser foot is in line with the slot on the shank.

- 4** Lower the presser foot lever and fix the presser foot onto the shank. If the presser foot is in the correct place, the bar should snap in.

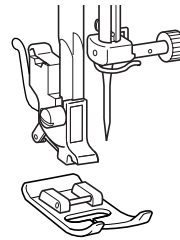

■ Presser foot installation orientation

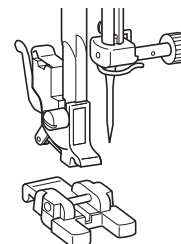
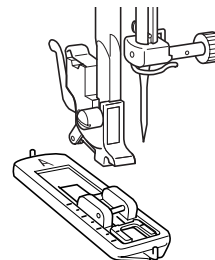
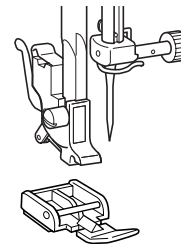

CAUTION

- If the presser foot is not installed with the correct orientation, the needle may strike the presser foot, which may bend or break the needle and cause injury.

Flat-Bed Attachment

The accessories are stored in a compartment inside the flat-bed attachment.

- 1 Slide the flat-bed attachment to the left to open it.

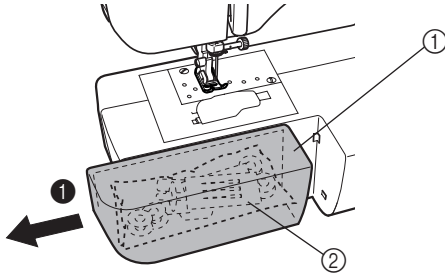

- 1 Flat-bed attachment
- 2 Storage compartment



Note

- Put the accessories inside a bag, and then store the bag inside the compartment. If the accessories are not in a bag, they may fall out, and be lost or damaged.

THE CONTROLS

Pattern Selection Dial



Note

- When you use the Pattern Selection Dial to choose a pattern, turn the balance wheel to the front (counterclockwise) to set the needle in the highest position. If the needle is in the down position when you turn the pattern selection dial, the needle, presser foot or fabric may be damaged.

To choose a stitch, simply turn the pattern selection dial in either direction. Stitch widths and lengths are shown on the following page.

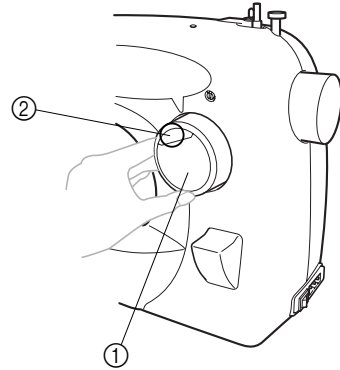

- ① Pattern selection dial
- ② Chosen pattern number

11 stitches

1	2	3	4	5	6	7	8	9	10	11

8 stitches









1	2	3	4	5	6	7	8

Patterns and Stitch Names

11 stitches

Pattern	Stitch Name	Stitch Width [mm(inch)]	Stitch Length [mm(inch)]	Twin Needle	Instruction Manual Page
1 	FOUR-STEP AUTOMATIC BUTTONHOLE	5.0 (3/16)	0.5 (1/32)	No	40
2 	STRAIGHT STITCH (Center Needle Position)	-	2.5 (3/32)	Yes	32, 44, 45
3 	STRAIGHT STITCH (Center Needle Position)	-	4.0 (3/16)	Yes	32, 45
4 	STRAIGHT STITCH (Left Needle Position)	-	2.5 (3/32)	No	32, 45
5 	TRIPLE STRETCH STITCH	-	2.5 (3/32)	No	32
6 	ELASTIC OVERLOCK STITCH	5.0 (3/16)	2.5 (3/32)	No	37
7 	ZIGZAG STITCH	3.0 (1/8)	1.5 (1/16)	Yes	34, 42, 46, 47
8 	ZIGZAG STITCH	5.0 (3/16)	2.0 (1/16)	No	34, 42, 46, 47
9 	ZIGZAG (SATIN) STITCH	5.0 (3/16)	0.5 (1/32)	No	34, 42, 46, 47
10 	BLIND HEM STITCH	5.0 (3/16)	2.0 (1/16)	No	36
11 	ELASTIC STITCH	5.0 (3/16)	1.0 (1/16)	No	36

8 stitches

Pattern	Stitch Name	Stitch Width [mm(inch)]	Stitch Length [mm(inch)]	Twin Needle	Instruction Manual Page
1 	FOUR-STEP AUTOMATIC BUTTONHOLE	5.0 (3/16)	0.5 (1/32)	No	40
2 	STRAIGHT STITCH (Center Needle Position)	-	2.5 (3/32)	Yes	32, 44, 45
3 	STRAIGHT STITCH (Center Needle Position)	-	4.0 (3/16)	Yes	32, 45
4 	STRAIGHT STITCH (Left Needle Position)	-	2.5 (3/32)	No	32, 45
5 	ZIGZAG STITCH	3.0 (1/8)	1.5 (1/16)	Yes	34, 42, 46, 47
6 	ZIGZAG STITCH	5.0 (3/16)	2.0 (1/16)	No	34, 42, 46, 47
7 	ZIGZAG (SATIN) STITCH	5.0 (3/16)	0.5 (1/32)	No	34, 42, 46, 47
8 	ELASTIC STITCH	5.0 (3/16)	1.0 (1/16)	No	36

Reverse Sewing Lever

You can use reverse sewing for back tacking and reinforcing seams.

To sew in reverse, push the Reverse Sewing Lever in as far as possible and hold it in that position while you lightly push the foot controller. To sew forward, release the Reverse Sewing Lever. The machine will then sew forward.

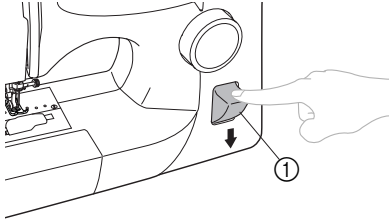

① Reverse sewing lever

Using a Free-arm Style

Free-arm sewing is convenient for sewing tubular and hard-to-reach areas. To change your machine to the free-arm style, lift out the flat-bed attachment.

- ① Slide the flat-bed attachment to the left to release it.

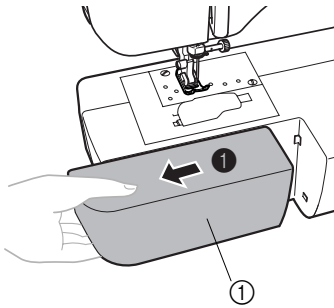

① Flat-bed attachment

THREADING THE MACHINE

Winding the Bobbin

CAUTION

- Only use the bobbin (part code: SA156, SFB (XA5539-151)) that has been designed for this sewing machine. Using of any other bobbin may cause damage to the machine.
- We designed the bobbin that comes with this machine. If you use bobbins from older models, the machine will not work properly. Only use the bobbin that comes with this machine or bobbins of the same type (part code: SA156, SFB (XA5539-151)).

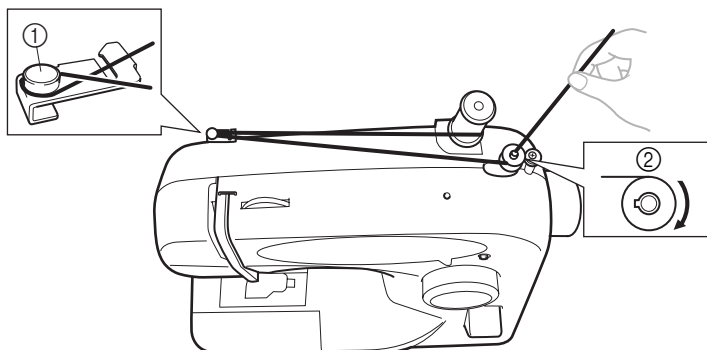
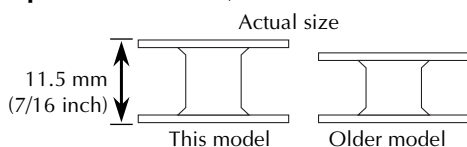

- ① Bobbin-winding tension disc
- ② Bobbin-winder shaft

- 1 Put the spool of thread on the spool pin and pass the thread around the bobbin-winding tension disc.

CAUTION

- If the spool of thread is not in the right place, the thread may tangle on the spool pin.

- 2 Pass the end of the thread through the hole on the bobbin from the inside of the bobbin.

- 3 Put the bobbin onto the bobbin-winder shaft and slide the bobbin-winder shaft to the right. Turn the bobbin clockwise, by hand, until the spring on the shaft slides into the groove of the bobbin.

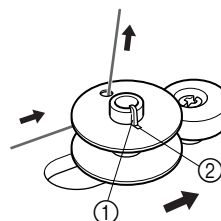

- ① Spring on the shaft
- ② Groove of the bobbin

- 4** While holding the end of the thread, gently press the foot controller to wind the thread around the bobbin a few times. Then stop the machine.

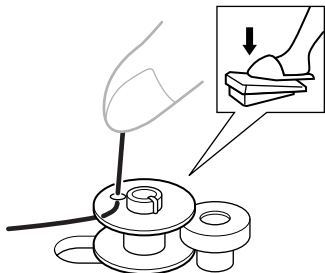

- 5** Trim the excess thread above the bobbin.

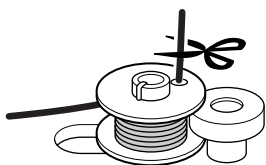

- 6** Press the foot controller to start.

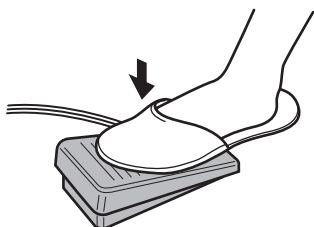

- 7** After the machine stops automatically when the bobbin is full, take your foot off the foot controller.

- 8** Cut the thread, slide the bobbin-winder shaft to the left and remove the bobbin.



Note

- The needle bar does not move when you slide the bobbin-winding shaft to the right.
- Immediately after winding the bobbin, it is normal to hear the sound of the clutch engaging when beginning to sew or turning the balance wheel.

CAUTION

- Make sure you follow the instructions carefully. If you do not cut the thread completely, and the bobbin is wound, when the thread runs low it may tangle around the bobbin and cause the needle to break.

CAUTION

- Not setting the bobbin properly may cause the thread tension to loosen, and may break the needle.



①

① Wound evenly



②

② Wound poorly

Lower Threading

- For more details on one-touch lower threading, see page 21.

CAUTION

- Setting the bobbin improperly may cause the thread tension to loosen, breaking the needle and resulting in injury.

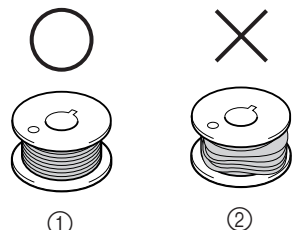

- ① Wound evenly
- ② Wound poorly

- The bobbin was designed specifically for this sewing machine. If bobbins from older models are used, the machine will not operate correctly. Use only the enclosed bobbin or bobbins of the same type (part code: SA156, SFB (XA5539-151)).

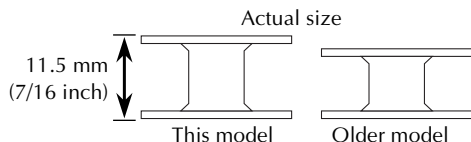

CAUTION

- Make sure you turn the power off while threading the machine. If you accidentally step on the foot controller and the machine starts to work, you could be injured.

- 1 Raise the needle to its highest position by turning the balance wheel toward you (counterclockwise) and raise the presser foot lever.

- 2 Slide the button and open the cover.

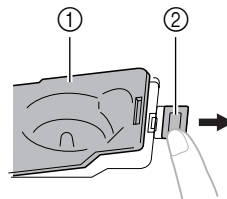

- ① Cover
- ② Slide button

- 3 Put the bobbin in so the thread comes out in the direction shown by the arrow.

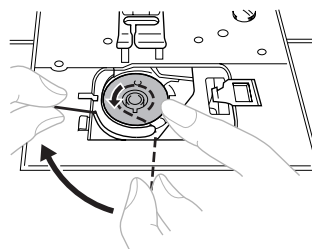

- Only use bobbins that were designed to be used with this machine.

CAUTION

- Make sure you set the bobbin so the thread unrolls in the right direction. If the thread unrolls in the wrong direction, it may cause the thread tension to be incorrect or break the needle.

- 4 Hold the end of the thread, push the bobbin down with your finger, and then pass the thread through the slit, as shown.

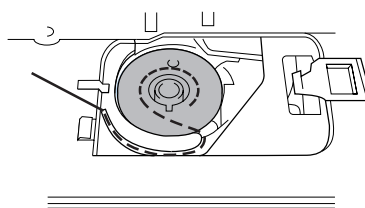

- 5** Replace the bobbin cover. Put the left tab in place (see arrow ①), and then press lightly on the right side (see arrow ②) until the cover clicks into place.

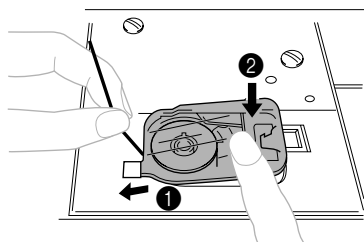

- Replace the cover so that the end of the thread comes out from the left side of the cover (as shown by the line in the diagram).

Lower Threading (For One-touch lower threading)

This is only available on certain models.

CAUTION

- Setting the bobbin improperly may cause the thread tension to loosen, breaking the needle and resulting in injury.

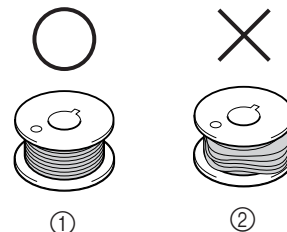

- ① Wound evenly
② Wound poorly

- The bobbin was designed specifically for this sewing machine. If bobbins from older models are used, the machine will not operate correctly. Use only the enclosed bobbin or bobbins of the same type (part code: SA156, SFB (XA5539-151)).

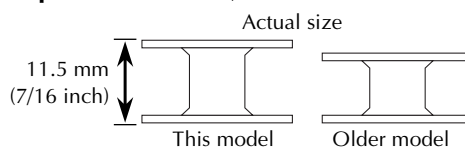

CAUTION

- Be sure to turn off the power. If you accidentally step on the foot controller and the machine begins to operate, injury could result.

- 1** Raise the needle to its highest position by turning the balance wheel toward you (counterclockwise) and raise the presser foot lever.

- 2** Slide the button and open the cover.

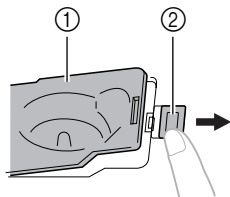

- ① Cover
- ② Slide button

- 3** Put the bobbin in, feed the end of the thread through the slit, and then pull the thread to cut it.

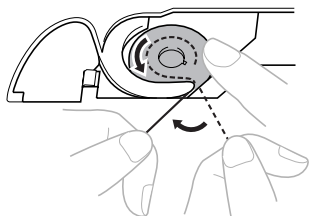

- Only use bobbins that were designed to be used with this machine.

CAUTION

- Make sure you set the bobbin so the thread unrolls in the right direction. If the thread unrolls in the wrong direction, it may cause the thread tension to be incorrect or break the needle.

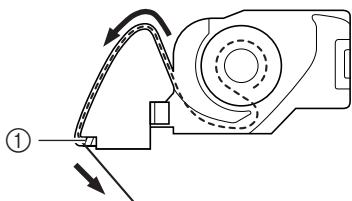

- ① Cutter

- 4** Replace the bobbin cover. Put the left tab in place (see arrow ①), and then press lightly on the right side (see arrow ②) until the cover clicks into place.

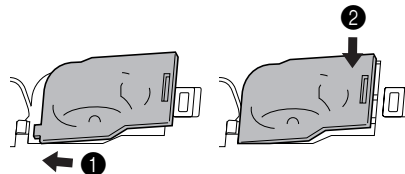

- You can begin sewing immediately without drawing up the bobbin thread. If you want to draw up the bobbin thread before you start to sew, follow to the procedure in “Drawing up the lower thread” (page 26).

Upper Threading

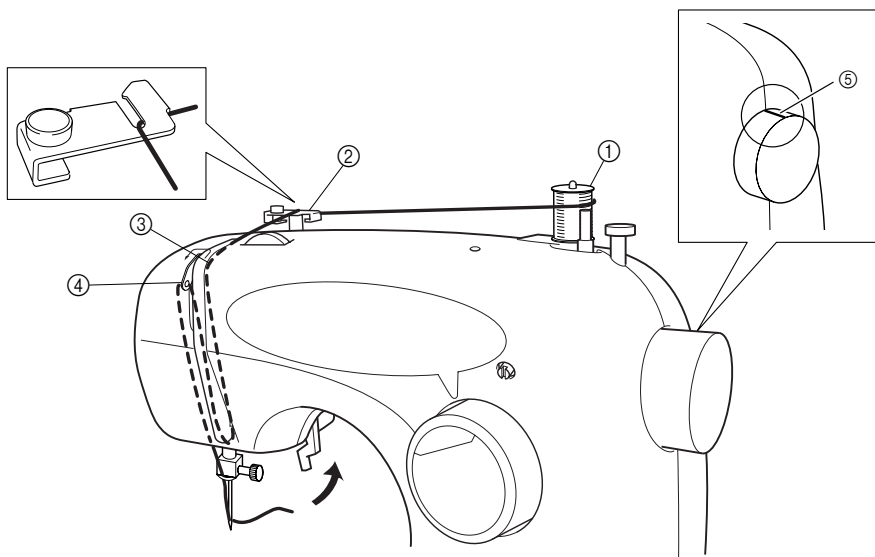

- ① Spool pin
- ② Thread guide (back)
- ③ Thread guide (front)
- ④ Thread take-up lever
- ⑤ Mark on the balance wheel

CAUTION

- Make sure you thread the machine properly. If you don't, the thread could tangle and break the needle.

IMPORTANT:

- 1 Raise the presser foot using the presser Foot Lever.

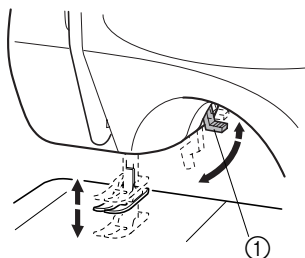

- ① Presser foot lever

- 2 Raise the needle to its highest position by turning the balance wheel toward you (counterclockwise) so that the mark on the balance wheel points directly up.

If the needle is not correctly raised, the sewing machine can not be threaded. Be sure to turn the balance wheel so that the mark on the wheel points up before threading the sewing machine.

- 3 Pull up the spool pin and put a spool of thread on this pin.

CAUTION

- If the spool of thread is in the wrong place, or is set incorrectly, the thread may tangle on the spool pin and cause the needle to break.

- 4 Feed the upper thread as shown in the diagram above. Pass the thread through both thread guides: the back one first, and then the front one.

- 5 Make sure you guide the thread through the thread take-up lever from right to left.

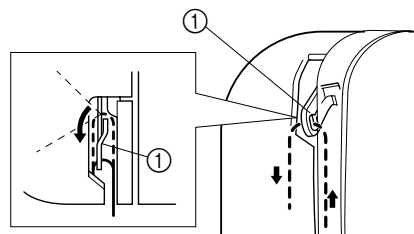

- ① Thread take-up lever

- 6 Put the thread behind the guide above the needle.
- 7 Thread the needle from front to back leaving a thread tail of about 5 cm (2 inches).

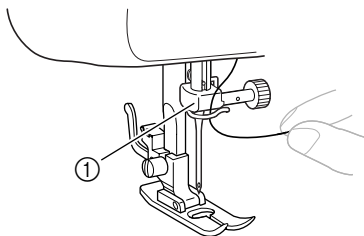

① Needle holder

- If your sewing machine is equipped with a needle threader, use the needle threader to thread the needle. (See page 24)

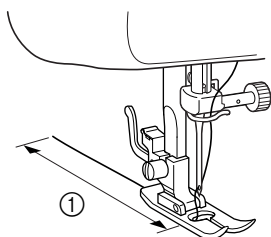

① 5 cm (2 inch)



Note

- If the thread take-up lever is lowered, the upper thread can not be wrapped around the thread take-up lever. Make sure you raise the Presser Foot Lever and the thread take-up before you feed the upper thread.
- If you incorrectly feed the thread you may cause sewing problems.

Using the Needle Threader (Models equipped with a needle threader)

Turn the power switch to 'O'.

- 1 Lower the presser foot lever.
- 2 Turn the balance wheel toward you (counterclockwise) to raise the needle holder to the highest position.

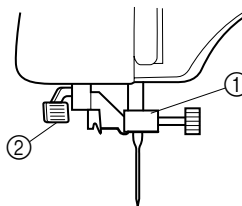

① Needle holder
② Needle threader lever



Note

- When you use the needle threader, make sure the needle holder is in the highest position, otherwise the hook may be damaged.

- 3 While lowering the needle threader lever, hook the thread onto the guide.

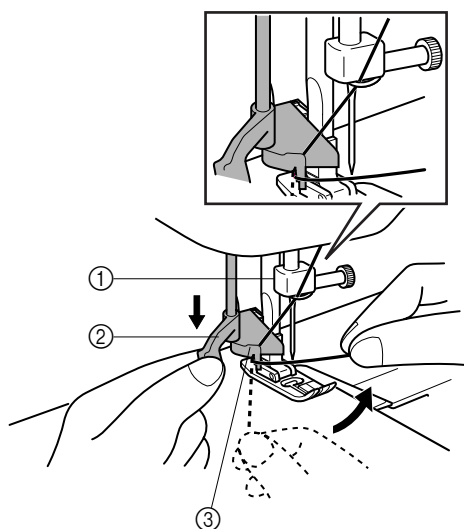

① Needle holder
② Needle threader lever
③ Guide

- 4** Pull down the needle threader lever as much as possible, and then turn the lever toward the back of the machine (away from you). Make sure that the hook passes through the eye of the needle and grabs the thread.

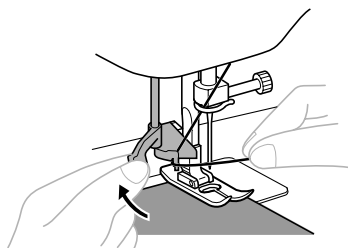

- Hold the thread in front of the needle to make sure that the hook grabs it.

- 5** While lightly holding the thread, turn the needle threader lever toward the front of the machine (toward you). The hook will pull the thread through the needle.

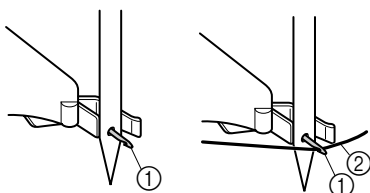

- ① Hook
- ② Thread

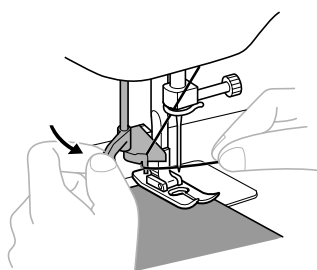

- 6** Raise the needle threader lever and pull out about 5 cm (2 inch) of thread through the needle toward the back of the sewing machine.

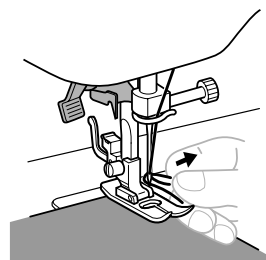
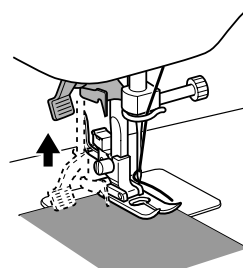

! CAUTION

- The needle threader can only be used with home sewing machine needles size 75/11-100/16. Check the table on page 47 for the appropriate needle and thread combinations. If you are using transparent nylon mono-filament thread, you can only use needles in the range of 90/14-100/16.
- You can not use the needle threader if you are using decorative threads or speciality needles, such as the twin needle and wing needle.
If you are using those types of threads or needles, thread the eye of the needle by hand. Make sure the main power switch is off when threading the needle by hand.

Drawing up the lower thread

- 1 While lightly holding the end of the upper thread, slowly turn the balance wheel to the front (counterclockwise) once by hand to lower and then raise the needle.

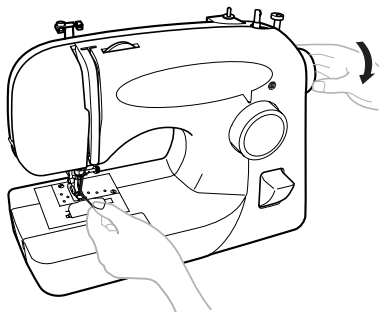

- 2 Pull on the upper thread to draw up the lower thread.

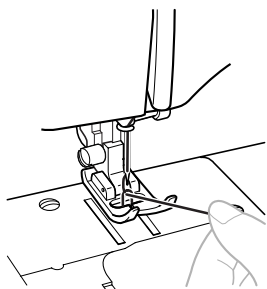

- 3 Pull out about 10 cm (4 inch) of both threads and put them toward the back of the machine under the presser foot.

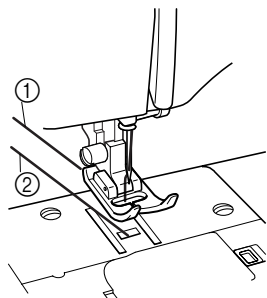

- ① Upper thread
- ② Lower thread

■ One-touch lower threading

This is only available on certain models.

You can begin sewing immediately without drawing up the bobbin thread. When sewing gathers or darts, you can draw up the lower thread by hand so that some thread will be left over. Before you draw up the lower thread, put the bobbin back in.

- 1 Pass the thread along the slit in the direction of the arrow, and leave it there without cutting it.

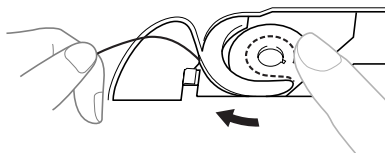

- The bobbin cover should still be removed.

- 2 Draw up the lower thread as described in steps 1 to 3.

- 3 Replace the bobbin cover.

Sewing with a Twin Needle

We have designed your machine so you can sew with this needle and two top threads. You can use the same color or two different colors of thread for making decorative stitches. Sewing with twin needles works well with the straight stitch (center needle position) and the zigzag stitch (3.0 mm (1/16 inch)). (see page 16)

CAUTION

- Use only twin needles that have been made for this machine (part code: X57521-001). Other needles could break, and damage the machine.
- You should only use the twin needle with the straight stitch (center needle position) and the zigzag stitch (3.0 mm (1/16 inch)). Do not use the twin needle with any other stitch.
- Do not sew with bent needles. The needle could break and injure you.
- When using the twin needle, make sure you use the zigzag presser foot only.

Attaching the Twin Needle

Attach the twin needle in the same way as a single needle (see page 12). The flat side of the needle should face toward the back and the rounded side should face toward you.

Attaching the Extra Spool Pin

Put the extra spool pin in the hole on the top of the machine. Put the second spool of thread onto the extra spool pin.

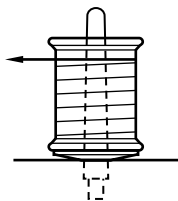

Twin Needle Threading

You should thread each needle separately.

- 1 **Threading the Left Needle**
Follow the same instructions for threading a single needle. See page 23 for more details.

- 2 **Threading the Right Needle**
Thread the right needle in the same way that you threaded the left needle using the thread from the spool on the extra spool pin, but do not pass the thread through the thread guide above the needle before you pass it through the eye of the right needle.

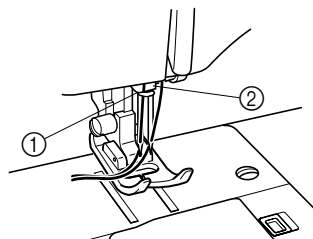

- ① Left needle thread passes through this guide.
- ② Right needle thread passes in front of this guide.

Note

Models that are equipped with a Needle Threader

- You can not use the needle threader to thread the twin needle. Instead, thread the twin needle by hand, from front to back. Using the needle threader may damage the machine.

Tension of the Thread

The tension of the thread will affect the quality of your stitches. You may need to adjust it when you change fabric or thread.



Memo

- We recommend that you do a test sample on scrap of a fabric before you start to sew.

■ Possible Problems If the Tension is Wrong

Upper tension is too tight.

Loops will appear on the surface of the fabric.

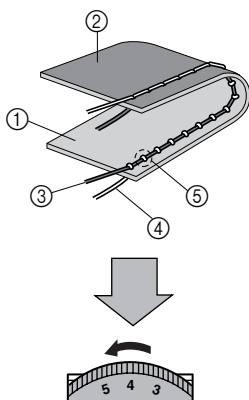

Solution

Reduce the tension by turning the Upper Tension Control Dial to a lower number.

Upper tension is too loose.

Loops appear on the back of the fabric.

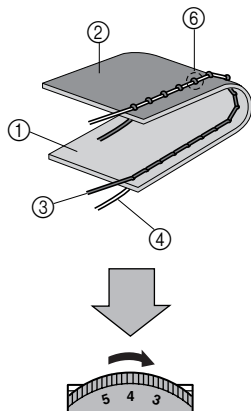

Solution

Increase the tension by turning the Upper Tension Control Dial to a higher number.

Correct tension

Correct tension is important as too much or too little tension will weaken your seams or cause puckers on your fabric.

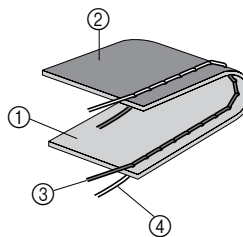

- ① Surface of fabric
- ② Back of fabric
- ③ Upper thread
- ④ Lower thread
- ⑤ Loops appear on surface of fabric
- ⑥ Loops appear on back of fabric.

FABRIC, THREAD, AND NEEDLE COMBINATIONS

1

Fabric Type		Thread		Size of Needle
		Type	Size	
Medium weight fabrics	Broadcloth	Cotton	60–80	75/11–90/14
	Taffeta	Thread synthetic mercerized		
	Flannel, Gabardine	Silk or silk finished	50–80	
Lightweight fabrics	Lawn, Batiste	Cotton	60–80	65/9–75/11
	Georgette	Thread synthetic mercerized		
	Challis, Satin	Silk	50–80	
Heavy weight fabrics	Denim	Cotton	30–50	90/14–100/16
	Corduroy	Thread synthetic mercerized	50	
	Tweed	Silk		
Stretch fabrics	Jersey	Thread for knits	50–60	Ball point needle (golden colored) 75/11–90/14
	Tricot			
For top-stitching		Thread synthetic mercerized	30	90/14–100/16
		Silk		



Memo

- For clear nylon thread, always use needle 90/14 - 100/16.
- You can also use the same thread for the bobbin thread and upper threading.



CAUTION

- Make sure you follow the needle, thread, and fabric combinations listed in the table. Using the wrong combination. For example, using heavyweight fabric such as denim with a small needle (for example, 65/9 - 75/11) may bend or break the needle. Also, the seam may be uneven, the fabric may pucker, or the machine may skip stitches.

2





STRAIGHT AND ZIGZAG STITCHING

Please Read Before Sewing

CAUTION

- To avoid being injured, watch the needle carefully while you are using the machine. Keep your hands away from moving parts.
- Do not stretch or pull the fabric during sewing. If you do, the needle may be damaged and you may be injured.
- Do not use bent or broken needles. If you do, you may be injured.
- Take care that the needle does not hit basting pins or other objects during sewing. The needle may break and you may be injured.
- Always use the correct presser foot. If you use the wrong presser, the needle may hit the presser foot and bend or break and you may also be injured.
- When you turn the balance wheel by hand, always turn it toward the front of the machine (counterclockwise). Turning it the other way may cause the thread to tangle and damage the needle or fabric. You may also be injured.

Straight Stitching

Stitch Name	Pattern	Stitch Length [mm (inch.)]
Straight Stitch (Center Needle Position)		2.5 (3/32)
Straight Stitch (Center Needle Position)		4.0 (3/16)
Straight Stitch (Left Needle Position)		2.5 (3/32)
Triple Stretch Stitch		2.5 (3/32)

■ Starting Sewing

- 1 Turn the Pattern Selection Dial to choose the stitch number you want. You also need to set the Pattern Selection Dial to Straight Stitch or Triple stretch stitch.
- 2 Raise the needle to its highest position and lift the presser foot lever.
- 3 Pull the upper thread through the toes of the presser foot.
- 4 Put the fabric under the presser foot and position the needle 1 cm (3/8 inch) from the edge of the fabric.
- 5 Lower the presser foot.

- 6 To back tack, push down the Reverse Sewing Lever as far as possible, and then press the foot controller to start reverse sewing. Release the foot controller to stop sewing.
- 7 Release the Reverse Sewing Lever and start sewing in the forward direction by pressing the foot controller.

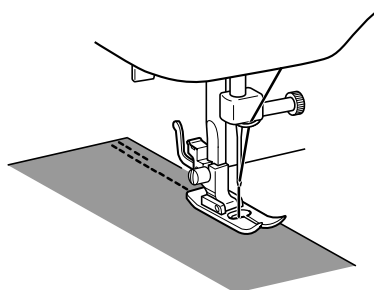

- You can use reverse sewing for locking the end of seams and where you need to strengthen a stitch.

CAUTION

- Make sure the needle does not hit a pin or any other object during sewing. The thread could tangle or the needle could break. You could also be injured.

■ Changing Sewing Direction

- 1 Stop the machine at the point where you want to change direction with the needle still in the fabric.
- 2 Raise the presser foot and turn the fabric to line up its new direction using the needle as a turning point for the fabric.

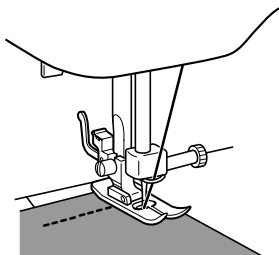

- 3 Lower the presser foot and start sewing in the new direction.

■ Finishing Sewing

You can use stitching to lock the threads at the end of the seam or where you need to strengthen a stitch.

- 1 Stitch to the end of the seam and stop.
- 2 Push the Reverse Sewing Lever and stitch backwards for 1 cm (3/8 inch) from the end of the fabric.

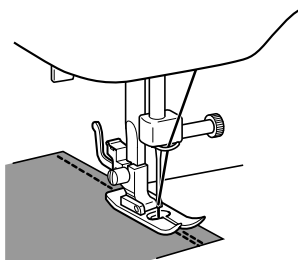

■ Removing the Material from the Machine

- 1 Stop the machine. Raise the needle to its highest position and make sure that the thread take-up lever is also in its highest position.
- 2 Lift the presser foot and pull the fabric out gently to the left hand side.
- 3 Cut both threads with the thread cutter on the left hand side of the machine.

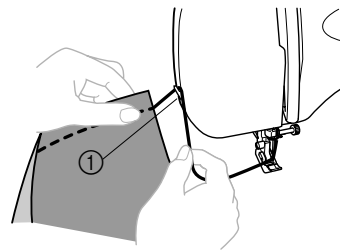

① Thread cutter



- 4 To prepare the machine for the next seam, pull about 10 cm (4 inch) of thread through the toes of the presser foot toward the back of the machine.

■ Top Stitching and Stretch Materials

You can use straight stitch for top stitching and sewing lightweight fabrics.

You can use triple stretch stitch for sewing stretch fabrics.

Zigzag Stitching

Stitch Name	Pattern	Stitch Length [mm (inch.)]	Stitch Width [mm (inch.)]
Zigzag Stitch		1.5 (1/16)	3.0 (1/8)
Zigzag Stitch		2.0 (1/16)	5.0 (3/16)
Zigzag (Satin) Stitch		0.5 (1/32)	5.0 (3/16)

■ Zigzag Stitch

Turn the pattern selection dial to zigzag stitch, and then start sewing.

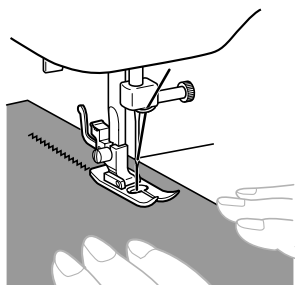

We recommend that you sew using the Straight Stitch at the beginning and end of the Zigzag Stitches.

(This acts as a reinforcement stitch.)

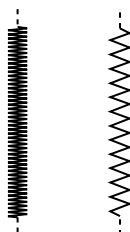

■ Zigzag (Satin) Stitch

You can use the zigzag (satin) stitch for making decorative stitches.

When sewing a zigzag (Satin) stitch, use a slightly looser upper-thread tension to produce more beautiful stitches.

You can adjust the length of the Zigzag (Satin) Stitch using the buttonhole fine-adjusting screw.

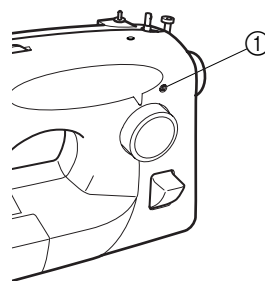

① Buttonhole fine adjusting screw

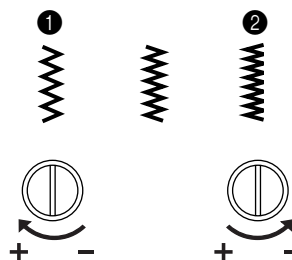

- ① For a longer stitch length, turn the buttonhole fine-adjusting screw with a large screwdriver in the + direction.
- ② For a shorter stitch length, turn the buttonhole fine-adjusting screw with a large screwdriver in the - direction.

3 **BUILT-IN STITCHES**

Blind Hem Stitching

Stitch Name	Pattern	Stitch Length [mm (inch.)]	Stitch Width [mm (inch.)]
Blind Hem Stitch		2.0 (1/16)	5.0 (3/16)

You can use the blind Hem Stitch to finish the edge of a project, like the hem of a pair of trousers, without the stitch showing.

- 1 Both the threads should be the same color as the fabric.
- 2 Fold back the hem, as shown in picture A. Then fold the edge of the fabric as in picture B. Leave a 6 mm (15/64 inch) overlap at the edge.
- 3 Set the Pattern Selection Dial to Blind Hem Stitch.
- 4 Sew on the fold as in picture C.

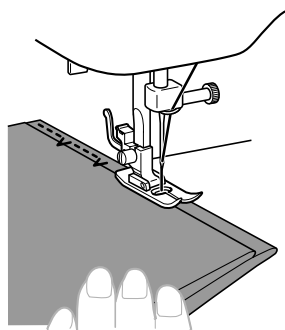

- 5 When the fabric is unfolded you will have a Blind hem stitch as shown in picture D.

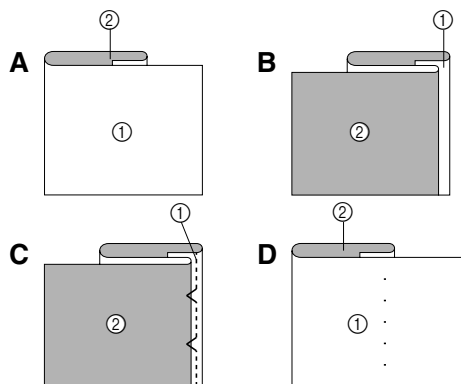

- ① Right side of fabric
② Wrong side of fabric

Elastic Stitching

Stitch Name	Pattern	Stitch Length [mm (inch.)]	Stitch Width [mm (inch.)]
Elastic Stitch		1.0 (1/16)	5.0 (3/16)

You can use the elastic stitch for mending, sewing elastic or joining fabric. Each is explained below. Set the Pattern Selection Dial to Elastic Stitch.

■ Mending

- 1 Place the reinforcement fabric under the area you want to mend.
- 2 Following the line of the tear, sew using the Elastic Stitch.

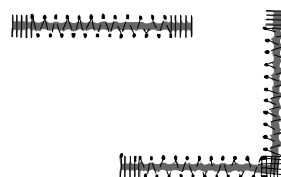

■ Sewing Elastic

- 1 Place the elastic on the fabric.
- 2 As you sew, stretch the elastic in front of and behind the presser foot.

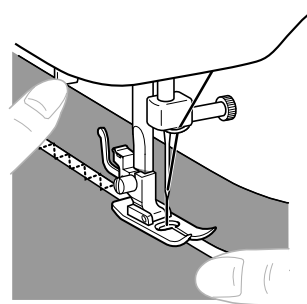

■ Joining Fabric

You can use the elastic stitch to join two pieces of fabric together and it is very effective when sewing knitted fabrics. If you are using nylon thread, the stitch will not be visible.

- 1** Put the edge of the two pieces of fabric together and center them under the presser foot.
- 2** Sew them together using the Elastic stitch. Make sure you keep the two fabric edges close together.

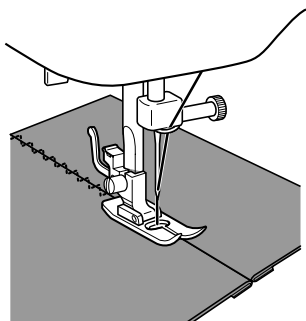

Overedge Stitching

Stitch Name	Pattern	Stitch Length [mm (inch.)]	Stitch Width [mm (inch.)]
Elastic Overlock Stitch		2.5 (3/32)	5.0 (3/16)

You can use this stitch to join together seams and finish them in one operation. It is also useful for sewing stretch materials.

- 1** Set the Pattern Selection Dial to the Elastic Overlock Stitch.
- 2** Put the fabric under the presser foot so that the seamline (or arrowhead point) is approximately 3 mm (1/8 inch) to the left of the center of the presser foot. This stitch works best with a seam allowance of approximately 5 mm (3/16 inch) as this allows the right (zigzag) side of the stitch to overlock the cut edge of the fabric.

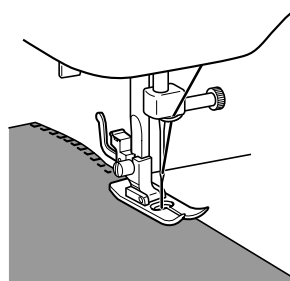

- 3** If the seam allowance is wider than the stitch pattern, trim away any excess fabric after stitching.

A finished Elastic Overlock Stitch is shown in the diagram below.

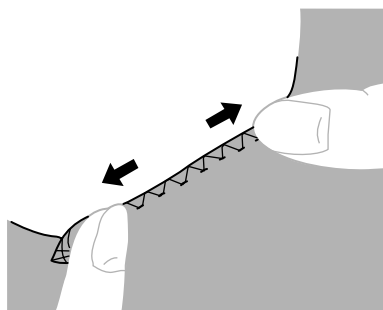

4

SEWING BUTTONHOLES AND BUTTONS

Making a Buttonhole

Pattern	Stitch Length [mm (inch.)]	Stitch Width [mm (inch.)]	Foot
	0.5 (1/32)	5.0 (3/16)	Buttonhole Foot



Memo

- We recommend that you practice making a buttonhole on a scrap piece of fabric before you try it on the actual garment.
- When making buttonholes on soft fabrics, place a stabilizer material on the underside of the fabric.

Making a buttonhole is a simple process that provides reliable results.

■ Making A Buttonhole

- 1 Using tailor's chalk, mark the position and length of the buttonhole on the fabric.
- 2 Attach the buttonhole foot and push the frame back until it stops with the plastic insert at the front of the frame.
- 3 You need to sew the front bar tack first. Line the bar tack mark under the center of the presser foot and match it up to the two lines on the presser foot.

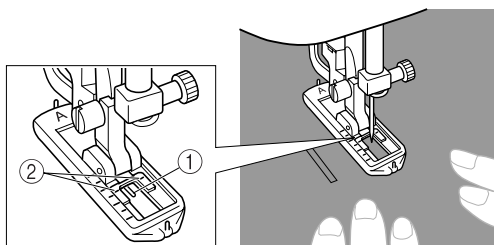









- 1 Front of chalk mark
- 2 Red lines

⚠ CAUTION

- If the presser foot is not installed with the correct orientation, the needle may strike the presser foot, which may bend or break the needle and cause injury.

■ Making A Buttonhole

Step	Sewn section	Pattern
Step 1 (Front bar tack)		
<ol style="list-style-type: none"> 1. Set the pattern selection dial to 'a'. 2. Lower the presser foot and sew 5 to 6 stitches. 3. Stop the machine when the needle is at the left side of the stitches and then raise the needle from the material. 		
Step 2 (Left side)		
<ol style="list-style-type: none"> 1. Turn the pattern selection dial to 'b'. 2. Sew the length of the tailor's chalk line. 3. Stop the machine when the needle is at the left side of the stitch and then raise the needle. 		
Step 3 (Back bar tack)		
<ol style="list-style-type: none"> 1. Turn the pattern selection dial to 'c' (same position as in step 1). 2. Sew 5 to 6 stitches. 3. Stop the machine when the needle is at the right side of the stitch and then raise the needle from the material. 		
Step 4 (Right side)		
<ol style="list-style-type: none"> 1. Set the pattern selection dial to 'd'. 2. Sew the right side until the needle reaches the stitches sewn in step 1. 		

■ Securing the Stitching and Cutting the Buttonhole

- 1 To secure the stitching, turn the material 90 degrees counterclockwise and sew Straight Stitches to the end of the front bar tack of the buttonhole.
- 2 Remove the material from the machine. We recommend that you put pins across both ends of the buttonhole as protection against cutting the stitches.
- 3 Cut an opening in the middle of the buttonhole with a seam ripper tool. Be careful not to cut through any stitches.

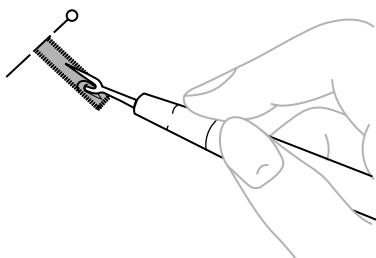

! CAUTION

- When using the seam ripper to open the buttonhole, do not put your hand or finger in the path of the ripper. The ripper may slip and injure you.

Adjusting Buttonholes

If the stitching on the two sides of the buttonhole is not the same, you can make the following adjustments.

- 1 After sewing the left side of the buttonhole, stitch the right side and observe the feeding.

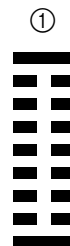

① Right row

- 2 If one side is too coarse or fine compared with the other side, adjust the buttonhole fine adjusting screw as shown below.

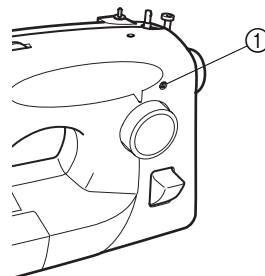

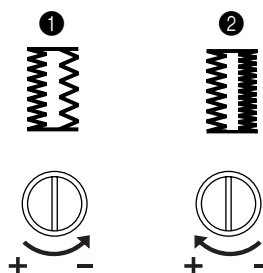

① Buttonhole fine-adjusting screw



- 1 If the right side is too coarse, turn the buttonhole fine adjusting screw with a large screwdriver in the - direction.
 - 2 If the right side is too fine, turn the buttonhole fine adjusting screw with a large screwdriver in the + direction.
- This adjustment allows both sides of the buttonhole to be the same.

Sewing Buttons

Stitch Name	Pattern	Stitch Width [mm (inch.)]	Foot	Other
Zigzag Stitch		3.0 (1/8)	Button Sewing Foot	Darning Plate
Zigzag Stitch		5.0 (3/16)		
Zigzag (Satin) Stitch		5.0 (3/16)		

- 1 Measure the distance between the buttonholes and set the pattern selection dial to the Zigzag Stitch for the width you want.
- 2 Remove the power supply plug from the outlet.
- 3 Change the foot to the Button sewing foot.
- 4 Place the darning plate on the needle plate.

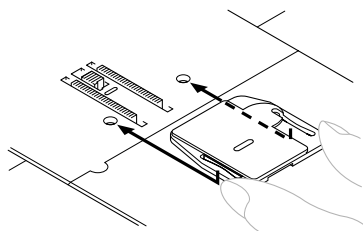

- 5 Connect the power supply plug into the wall outlet.
- 6 Put a button between the foot and the fabric and make sure that the needle enters the holes without hitting the button. If it hits, see Step 1.

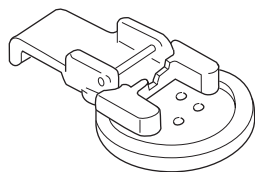

- 7 At a slow speed, sew about 10 stitches.

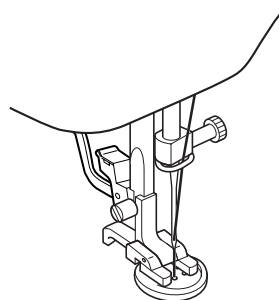

- 8 Remove the material from the machine. Cut the upper and lower threads and tie both threads at the back of the material.



CAUTION

- Make sure the needle does not hit the button during sewing. The needle may break and you may be injured.

5

USING ATTACHMENTS AND APPLICATIONS

Zipper Insertion

Stitch Name	Pattern	Stitch Length [mm (inch.)]	Foot
Straight Stitch (Center Needle Position)		2.5 (3/32)	Zipper Foot

You can use the zipper foot to sew different types of zips, and can easily position it to the right or left side of the needle.

When sewing the right side of the zipper, attach the shank to the left pin of the zipper foot. When sewing the left side of the zipper, attach the shank to the right pin of the zipper foot.

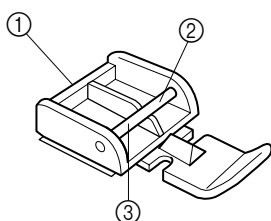

- ① Zipper foot
- ② Right pin for sewing the left side of the zipper
- ③ Left pin for sewing the right side of the zipper

- 1** Set the Pattern Selection Dial to Straight Stitch (Center Needle Position. (2.5mm (3/32 inch))).
- 2** Lower the presser foot lever and fix either the left or right pin of the zipper foot onto the shank.
- 3** Fold the edge of the material 2 cm (3/4 inch) and place the zipper under the folded section. Lower the needle into the notch located either on the left or right side of the zipper foot.

CAUTION

- Turn the balance wheel by hand to make sure the needle does not hit the presser foot before you start sewing. If you choose a different stitch, the needle will hit the presser foot and break the needle. You may also be injured.

- 4** Sew from the bottom of the zipper toward the top on both sides. The needle should be positioned on the zipper side of the foot for best results.

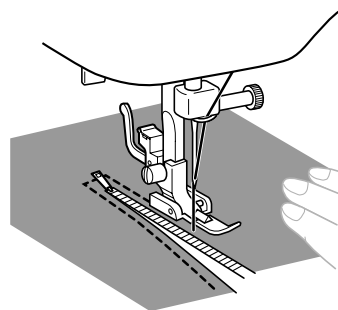



- 5** To sew the opposite side of the zipper, release the foot by pressing the button located at the back of the presser foot, fit the zipper foot on the other side of the zipper and continue sewing using the other side notch.

CAUTION

- Make sure the needle does not hit the zipper during sewing. If the needle hits the zipper, the needle may break and you may be injured.



Gathering

Stitch Name	Pattern	Stitch Length [mm (inch.)]
Straight Stitch (Center Needle Position)		2.5 (3/32)
Straight Stitch (Center Needle Position)		4.0 (3/16)
Straight Stitch (Left Needle Position)		2.5 (3/32)

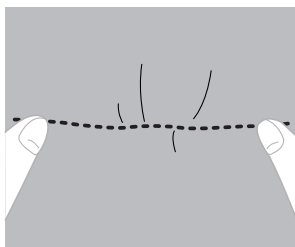
- 1 Set the Pattern Selection Dial to Straight Stitch.
- 2 Loosen the tension of the upper thread so that the lower thread lies on the underside of the material.
- 3 Sew a single row (or many rows) of Straight Stitches.
- 4 Pull the lower threads to gather the material.



Darning

Stitch Name	Pattern	Stitch Length [mm (inch.)]	Foot	Other
Straight Stitch (Center Needle Position)		2.5 (3/32)	Zigzag Presser Foot	Darning Plate
Straight Stitch (Center Needle Position)		4.0 (3/16)		
Straight Stitch (Left Needle Position)		2.5 (3/32)		

- 1 Remove the power supply plug from the outlet. Put the darning plate on the needle plate. Connect the power supply plug into the wall outlet.

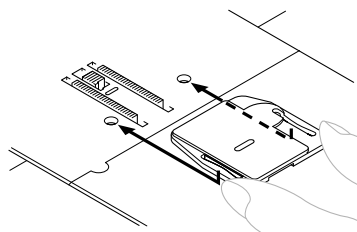

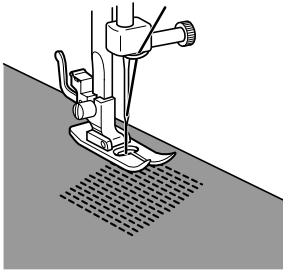

- 2 Set the Pattern Selection Dial to Straight Stitch.
- 3 Put the section you want to darn under the presser foot, together with a fabric for reinforcement.
- 4 Lower the presser foot.
- 5 Begin sewing by alternating between gently drawing the work away from you and pulling it toward you.

- 6** Repeat this motion until the darn section is filled with parallel lines of stitching.



Appliqués

Stitch Name	Pattern	Stitch Length [mm (inch.)]	Stitch Width [mm (inch.)]
Zigzag Stitch		1.5 (1/16)	3.0 (1/8)
Zigzag Stitch		2.0 (1/16)	5.0 (3/16)
Zigzag (Satin) Stitch		0.5 (1/32)	5.0 (3/16)

You can create an applique by cutting a different piece of fabric into a shape and using it as a decoration.

- 1** Baste the cut design to the fabric.
- 2** Carefully sew around the edge of the design with a Zigzag Stitch.

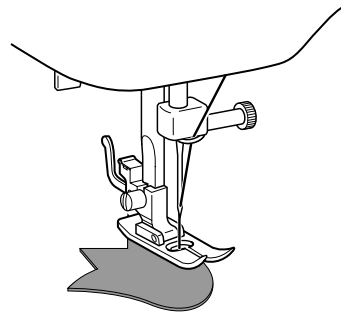

- 3** Cut away any fabric that is left outside the stitching.

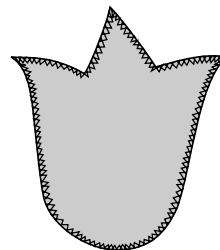

- 4** Remove the basting, if necessary.





Memo

- Make reinforcing Straight Stitches at the beginning and the end of the zigzag stitching.

CAUTION

- Be careful that the needle does not hit a pin during sewing, as the needle can break. You may also be injured.

Monogramming and Embroidering

Stitch Name	Pattern	Stitch Length [mm (inch.)]	Stitch Width [mm (inch.)]	Foot	Other
Zigzag Stitch		1.5 (1/16)	3.0 (1/8)	None	Darning Plate
Zigzag Stitch		2.0 (1/16)	5.0 (3/16)		
Zigzag (Satin) Stitch		0.5 (1/32)	5.0 (3/16)		

■ Preparing for sewing a Monogram and Embroidering

- 1 Remove the power supply plug from the outlet. Place the darning plate on the needle plate. Connect the power supply plug into the wall outlet.

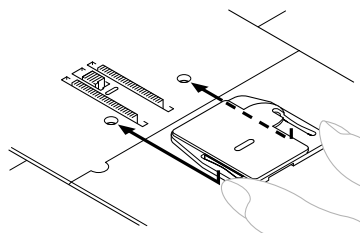

- 2 Set the Pattern Selection Dial to the appropriate Zigzag Stitch setting.
- 3 Draw the lettering (for monogramming) or design (for embroidering) on the surface of the fabric.
- 4 Stretch the fabric between embroidery hoops as firmly as possible, with the underside of the fabric on the bottom of the inside hoop.
- 5 Put the work under the needle and lower the presser bar with the foot removed.

- 6** Pull the lower thread up through the work at the starting position by turning the balance wheel and make a few holding stitches.

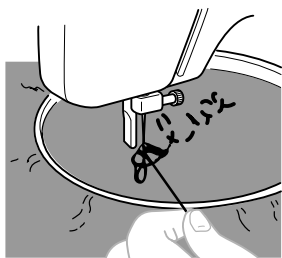

- 7** Grip the hoop with your thumbs and forefingers while pressing the fabric with your middle and third fingers and supporting the outside of the hoop with your little fingers.

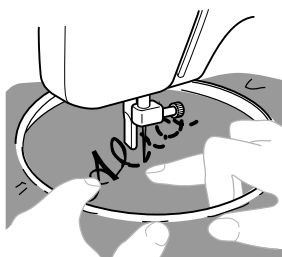

■ Monogram

- 1** Sew by moving the hoop slowly along the lettering at a constant speed.
- 2** Secure with a few straight stitches at the end of the last letter.

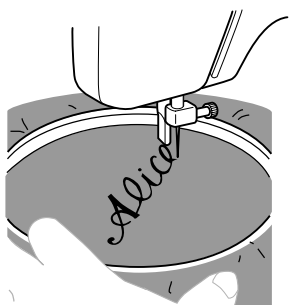

■ Embroidering

- 1** Stitch the outline of the design by moving the embroidery hoop.

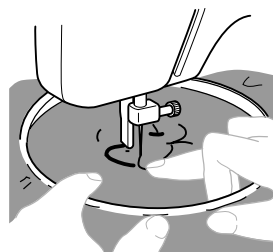

- 2** Fill in the design alternating from the outline of the design to the inside and from the inside to the edge of the outline until the design is completely filled in. Keep the stitching close together.

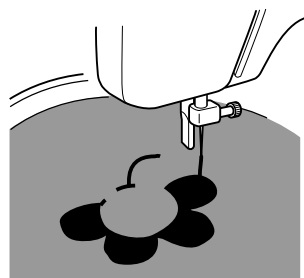





Memo

- You can make long stitches by moving the embroidery hoop rapidly and short stitches by moving it slowly.

- 3** Secure with a few Straight Stitches at the end of the design.

OPTIONAL ACCESSORIES

Using the Walking Foot

Stitch Name	Pattern	Stitch Length [mm (inch.)]	Stitch Width [mm (inch.)]
Straight Stitch (Center Needle Position)		2.5 (3/32)	-
Straight Stitch (Center Needle Position)		4.0 (3/16)	
Zigzag Stitch		1.5 (1/16)	3.0 (1/8)
Zigzag Stitch		2.0 (1/16)	5.0 (3/16)
Zigzag (Satin) Stitch		0.5 (1/32)	5.0 (3/16)

This foot is very useful for sewing materials such as vinyl cloth, synthetic leather, and thin leather, etc. These materials are difficult to feed when sewing. The walking foot prevents these materials from crumpling, slipping or sticking between the presser foot and material.



Note

- Only use the walking foot for straight sewing (Center Needle Position) and zigzag stitching. Do not use other patterns.

- 1 Switch the machine off.
- 2 Raise the needle and the presser foot.

- 3 Loosen the presser foot screw to remove the presser-foot holder.

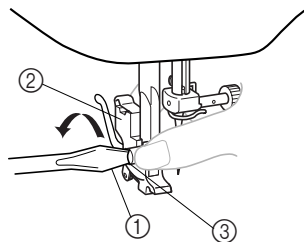

- 1 Use a screwdriver
- 2 Presser-foot holder
- 3 Presser-foot screw

- 4 Attach the forked section of the connecting lever to the needle clamp, and fit the walking foot to the presser bar.

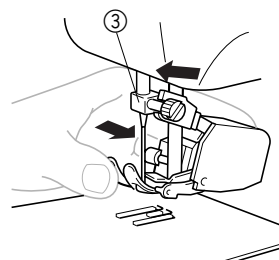
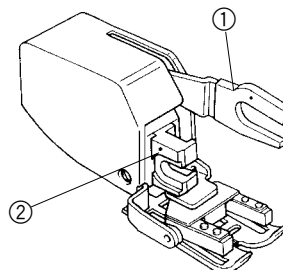

- 1 Forked part of operation lever
- 2 Presser bar holder
- 3 Needle clamp

- 5** Lower the presser foot lever and then tighten the presser foot screw.

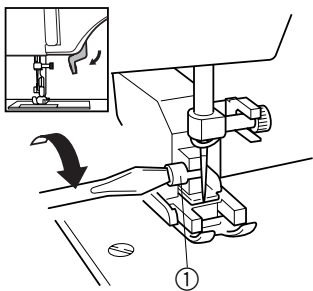

① Presser-foot screw

CAUTION

- Use a screwdriver to tighten the screw securely. If the screw is loose, the needle may hit the presser foot and you may be injured.
- Before you start sewing, make sure you turn the balance wheel toward the front of the machine to check that the needle does not hit the presser foot.
- Be careful not to touch the needle, otherwise you may be injured.



Note

- When sewing with the walking foot, sew at medium to low speeds.

Using the Quilting Foot

Stitch Name	Pattern	Stitch Length [mm (inch.)]	Other
Straight Stitch (Center Needle Position)		2.5(3/32)	Darning Plate
Straight Stitch (Center Needle Position)		4.0(3/16)	

The Quilting Foot is useful for darning and freemotion machine quilting.

- 1** Remove the power supply plug from the outlet.
- 2** Raise the needle and the presser foot.
- 3** Loosen the presser-foot screw to remove the presser-foot holder.

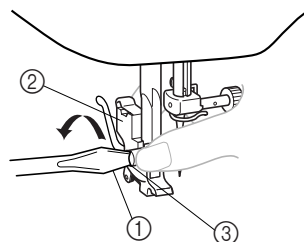

- ① Use a screwdriver
- ② Presser-foot holder
- ③ Presser-foot screw

- 4** Attach the quilting foot, making sure that part **A** shown in the diagram is above the needle clamp screw. Then lower the Presser Foot Lever and tighten the presser-foot screw.
 - Make sure that the needle clamp screw is firmly tightened.

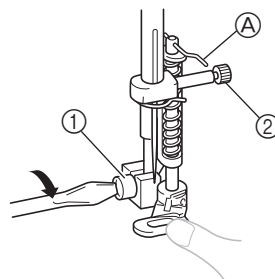

- ① Presser-foot screw
- ② Needle clamp screw

⚠ CAUTION

- Be careful not to touch the needle, otherwise you may be injured.
- Use a screwdriver to tighten the presser foot holder screw securely. If the screw is loose, the needle may hit the presser foot and you may be injured.
- Before you start sewing, make sure you turn the balance wheel toward the front of the machine to check that the needle does not hit the presser foot.

- 5** Put the darning plate on the needle plate. Connect the power supply plug into the wall outlet.

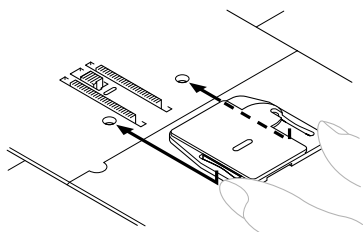

- 6** Set the Pattern Selection Dial to Straight Stitch (Center Needle Position).
- Before starting to sew, draw the quilting design on the fabric.

- 7** Use both hands to keep the fabric firmly stretched and move the fabric to sew over the drawn design.

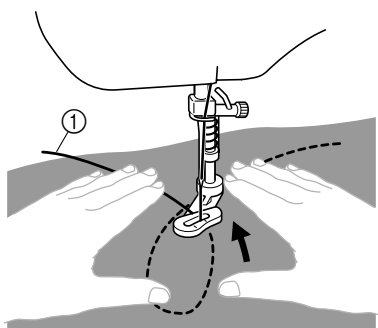

① Quilting design (Line)

- 8** The length of the stitch depends on how quickly you move the fabric and on the machine's sewing speed. Sew while moving the fabric slowly.

Using the 1/4-Inch Quilting Foot

Stitch Name	Pattern	Stitch length [mm(inch)]
Straight Stitch (Center Needle Position)		2.5 (3/32)

You can use the 1/4-Inch Quilting Foot to sew fixed seams when piecing together a quilt.

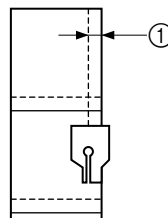
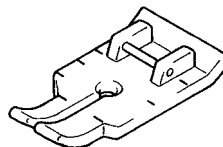

① Seam allowance 6.5 millimetres (1/4 inch)

- 1** Set the Pattern Selection Dial to Straight Stitch (Center Needle Position) (2.5mm (3/32 inch)).
- 2** Change the foot to the 1/4-Inch Quilting Foot.
- 3** Position the presser foot over the fabric and sew, as shown in the diagram below.
- Achieving an accurate seam allowance.

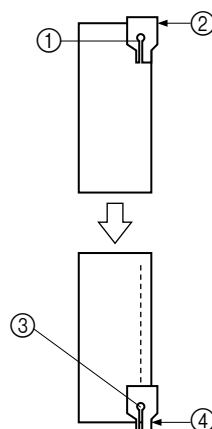

- ① Beginning of stitching.
 ② Align this mark up the edge of the fabric.
 ③ End of stitching
 ④ Align this mark up the edge of the fabric.

■ Quickly stitch together a quilt.

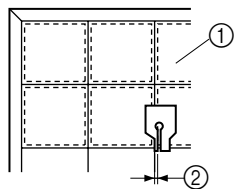

- ① Top of fabric.
- ② Seam 3.2 millimetres (1/8 inch)



6 APPENDIX

MAINTENANCE

Changing the Light Bulb

⚠ CAUTION

- Turn off the main power switch and unplug the machine before you change the light bulb. If the main power switch is on when you change the light bulb, you may get an electric shock. If the machine is on and you step on the foot controller, you may be injured.
- To avoid burns, let the light bulb cool down before you change it.

- 1 Remove the power supply plug from the outlet.
- 2 Loosen the screw on the back of the sewing head. Then remove the light cover from the machine.

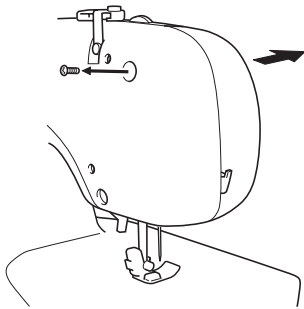

- 3 Replace the sewing light bulb.

- 1 Loosen
- 2 Tighten

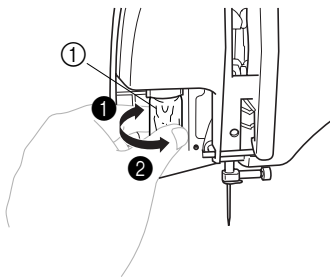

① Bulb

- 4 Put the light cover back on and fasten the screw.

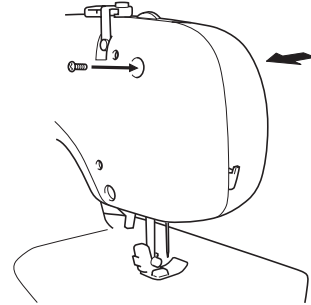

Cleaning

! CAUTION

- Make sure you unplug the machine before you clean it. Otherwise, you may get an electric shock or be injured.

- 1 Switch the machine off and unplug it.
- 2 Raise the needle and the presser foot.
- 3 Loosen the presser-foot screw and the needle clamp screw to remove the presser-foot holder and the needle.

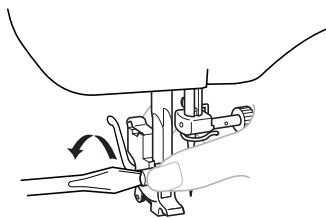

- 4 Grasp both sides of the needle plate cover, and then slide it toward you to remove the needle plate cover.

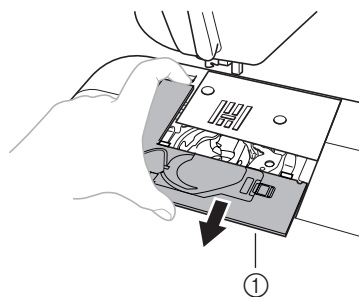

① Needle plate cover

- 5 Turn the balance wheel toward you until the tip of the shuttle hook aligns with the edge of the shuttle race shelf.

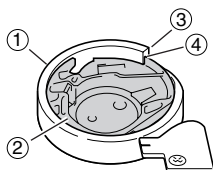

- ① Shuttle-race shelf
- ② Shuttle
- ③ Edge of the shuttle race
- ④ Tip of the shuttle hook

! CAUTION

- Make sure you turn the balance wheel toward the front of the machine (counterclockwise). Turning the balance wheel in the other direction may damage the machine.

- 6 Remove the shuttle.
Grasp the shuttle, and then pull it out.

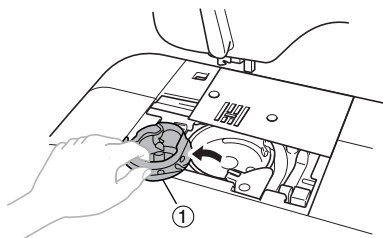

① Shuttle

- 7 Use the cleaning brush or a vacuum cleaner to remove any dust from the shuttle race and its surrounding area.

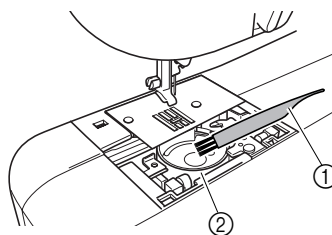

- ① Cleaning brush
- ② Shuttle race

- Do not put oil on the shuttle.

- 8** Check that the edge of the race shelf is positioned as in step **5**, and then put the shuttle in so that the projection on the shuttle lines up with the spring.

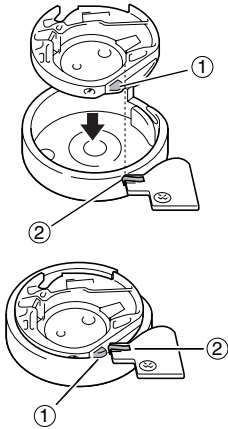

- ① Projection
② Spring

- 9** Put the tabs on the needle plate cover into the needle plate, and then slide the cover back on.

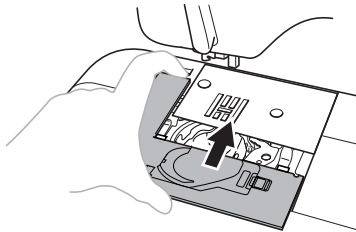

CAUTION

- Never use a shuttle that is scratched, otherwise the upper thread may become tangled, the needle may break or sewing performance may suffer. For a new shuttle (part code: XC3152-021), contact your nearest authorized service center.
- Make sure that you fit the shuttle properly, otherwise the needle may break.

Troubleshooting

If the machine stops working properly, check the following possible problems.

If the problem is still there, contact your retailer or the nearest authorized service center.

Symptom	Possible cause	How to put it right	Reference
The sewing machine does not work.	The machine is not plugged in.	Plug the machine in.	page 10
	The main power switch is turned off.	Turn on the main power switch.	page 11
	The bobbin-winder shaft is pushed to the right.	Move the bobbin-winder shaft to the left.	page 18
	You have not used the foot controller properly.	Use the foot controller properly.	page 11
The needle breaks.	The needle is not fitted properly.	Fit the needle properly.	page 12
	The needle clamp screw is loose.	Use the screwdriver to firmly tighten the screw.	
	The needle is bent or blunt.	Replace the needle.	page 11, 12
	You have not used the right combination of fabric, thread and needle.	Choose a thread and needle that are appropriate for the type of fabric.	page 29
	The presser foot you are using is not appropriate for the type of stitch that you want to sew.	Attach the presser foot that is correct for the type of stitch that you want to sew.	–
	The upper thread tension is too tight.	Loosen the upper thread tension.	page 28
	You are pulling the fabric too much.	Lightly guide the fabric.	–
	You have not fitted the spool properly.	Fit the spool properly.	page 23, 27
	The area around the hole in the needle plate is scratched.	Replace the needle plate. Contact your retailer or the nearest authorized service center.	–
	The area around the hole in the presser foot is scratched.	Replace the presser foot. Contact your retailer or the nearest authorized service center.	–
	The shuttle is scratched.	Replace the shuttle. Contact your retailer or the nearest authorized service center.	–
	You have not used a bobbin that has been designed for this machine.	Incorrect bobbins will not work properly. Only use a bobbin that has been designed for this machine.	page 18

Symptom	Possible cause	How to put it right	Reference
The upper thread breaks.	You have not threaded the upper thread properly. (for example, you have not fitted the spool properly, or the thread has come out of the guide above the needle.)	Correct the upper threading.	page 23
	There are knots or tangles in the thread.	Remove any knots or tangles.	–
	The needle is not appropriate for the thread you are using.	Choose a needle that is appropriate for the type of stitch.	page 29
	The upper-thread tension is too tight.	Loosen the upper-thread tension.	page 28
	The thread is tangled, for example, in the shuttle.	Remove the tangle thread. If the thread is tangled in the shuttle, clean the shuttle.	page 55
	The needle is bent or blunt.	Replace the needle.	page 11, 12
	You have not fitted the needle properly.	Fit the needle properly.	page 12
	The area around the hole in the needle plate is scratched.	Replace the needle plate. Contact your retailer or the nearest authorised service center.	–
	The area around the hole in the presser foot is scratched.	Replace the presser foot. Contact your retailer or the nearest authorised service center.	–
	The shuttle is scratched, or has a burr on it.	Replace the shuttle. Contact your retailer or the nearest authorised service center.	–
	You have not used a bobbin that has been designed for this machine.	Incorrect bobbins will not work properly. Only use a bobbin that has been designed for this machine.	page 18
The lower thread is tangled or breaks.	You have not fitted the bobbin thread properly.	Fit the bobbin properly.	page 20, 21
	The bobbin is scratched or does not turn smoothly.	Replace the bobbin.	–
	The thread is tangled.	Remove the tangled thread and clean the shuttle.	page 55
	You have not used a bobbin that has been designed for this machine.	Incorrect bobbins will not work properly. Only use a bobbin that has been designed for this machine.	page 18
The thread tension is incorrect.	You have not threaded the upper thread properly.	Correct the upper threading.	page 23
	You have not fitted the bobbin thread properly.	Fit the bobbin thread properly.	page 20, 21
	You have not threaded the right combination of thread and needle for the fabric you are using.	Choose a thread and needle that are appropriate for the type of fabric.	page 29
	You have not fitted the presser-foot holder properly.	Fit the presser-foot holder properly.	–
	The thread tension is incorrect.	Adjust the tension of the upper thread.	page 28
	You have not used a bobbin that has been designed for this machine.	Incorrect bobbins will not work properly. Only use a bobbin that has been designed for this machine.	page 18

Symptom	Possible cause	How to put it right	Reference
The fabric is wrinkled.	You have not threaded the upper thread properly or fitted the bobbin properly.	Thread the upper thread and fit the bobbin thread properly.	page 20, 23
	You have not fitted the spool properly.	Fit the spool properly.	page 23, 27
	You have not used the right combination of fabric, thread and needle.	Choose a thread and needle that are appropriate for the type of fabric.	page 29
	The needle is bent or blunt.	Replace the needle.	page 11, 12
	If you are sewing thin fabric, the stitch is too thick.	Sew with stabiliser material under the fabric.	–
	The thread tension is incorrect.	Adjust the tension of the upper thread.	page 28
Stitches are skipped.	You have not threaded the upper thread properly.	Correct the upper threading.	page 23
	You have not used the right combination of fabric, thread and needle.	Choose a thread and needle that are appropriate for the type of fabric.	page 29
	The needle is bent or blunt.	Replace the needle.	page 11, 12
	You have not fitted the needle properly.	Fit the needle properly.	page 12
	Dust has accumulated under the needle plate or in the shuttle.	Remove the needle plate cover and clean the plate and the shuttle.	page 55
There is a high-pitched noise while sewing.	Dust has built up in the feed dogs or in the shuttle.	Clean the shuttle.	page 55
	You have not threaded the upper thread properly.	Correct the upper threading.	page 23
	The shuttle is scratched.	Replace the shuttle. Contact your retailer or the nearest authorized service center.	–
	You have not used bobbin that has been designed for this machine.	Incorrect bobbins will not work properly. Only use a bobbin that has been designed for this machine.	page 18
The needle threader can not be used.	You have not moved the needle holder to its highest position.	Turn the balance wheel toward you (counterclockwise) to raise the needle holder to the highest position.	page 24
	You have not fitted the needle properly.	Fit the needle properly.	page 12
The stitch is not sewn correctly.	The presser foot that you are using is not correct for the type of stitch.	Attach the presser foot that is correct for the type of stitch that you want to sew.	–
	The thread tension is incorrect.	Adjust the tension of the upper thread.	page 28
	The thread is tangled, for example, in the shuttle.	Remove the tangle thread. If the thread is tangled in the shuttle, clean the shuttle.	page 55

Symptom	Possible cause	How to put it right	Reference
The fabric does not feed.	The darning plate is fitted on the needle plate.	Remove the darning plate.	–
	You have not used the right combination of fabric, thread and needle.	Choose a thread and needle that are appropriate for the type of fabric.	page 29
	The thread is tangled, for example, in the shuttle.	Remove the tangle thread. If the thread is tangled in the shuttle, clean the shuttle.	page 55
The sewing light bulb does not come on.	The sewing light bulb is damaged.	Replace the sewing light bulb.	page 54

Repacking the Machine

Keep the carton and packing materials. You may have to take or send the machine to be repaired or wish to move the machine. If you do not pack it properly, or do not use the right packing material, the machine could be damaged.

Please follow the diagram below for repacking.

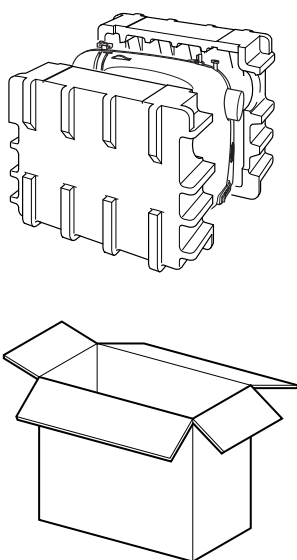

IMPORTANT

- This packing material is designed to prevent damage. Save this packing material if you need to move the machine or take or send this machine to be repaired.

INDEX

Numerics

1/4-Inch Quilting Foot 9, 51

A

Accessories 9
Appliqués 46

B

Blind Hem Stitching 36
Bobbin Winder 18
Buttonhole 40
Buttonhole Fine Adjusting Screw 34, 41

C

Changing the Light Bulb 54
Changing the Presser Foot 13
Checking the Needle 11
Cleaning 55
Connecting Plugs 10

D

Darning 45
Drawing Up Lower Thread 26

E

Elastic Overlock Stitch 37
Elastic Stitch 36
Embroidering 47

F

FABRIC/THREAD/NEEDLE COMBINATIONS 29
Flat bed attachment with accessory compartment ... 14, 17
Foot Controller 11
Foot Controller Jack 10
Free-arm Style 17

G

Gathering 45

H

Hole for Extra Spool Pin 27

L

Lower Threading 20

M

Main Parts 8
Main Power and Sewing Light Switch 11
Monogramming 47

N

Needle
Inspecting 11
Replacement 12
Needle Inspection 11

O

Overedge Stitching 37

P

Pattern Selection Dial 15
Presser Foot Lever 23

Q

Quilting Foot 9, 50

R

Repacking the Machine 60
Reverse Sewing Lever 17

S

Sewing Buttons 42
Sewing Light Bulb Replacement 54
Sewing Light Switch 11
Sewing with a Twin Needle 27
Shuttle 55
Spool pin 18, 23
Straight Stitch 32, 44, 45

T

Thread Tension 28
Triple Stretch Stitch 32
Troubleshooting 57
Twin Needle Sewing 27

U

Upper Tension Control Dial 28
Upper Threading 23

W

Walking Foot 9, 49
Winding the Bobbin 18

Z

Zigzag Presser Foot 8, 13
Zigzag Stitch 34, 42, 46, 47
Zipper Foot 9, 44
Zipper Insertion 44

