

BES-116AC

INSTRUCTION MANUAL

BROTHER
EMBROIDERY
SYSTEMS



Please read this manual before using the machine.
Please keep this manual within easy reach for quick reference.

ELECTRONIC EMBROIDERY MACHINE

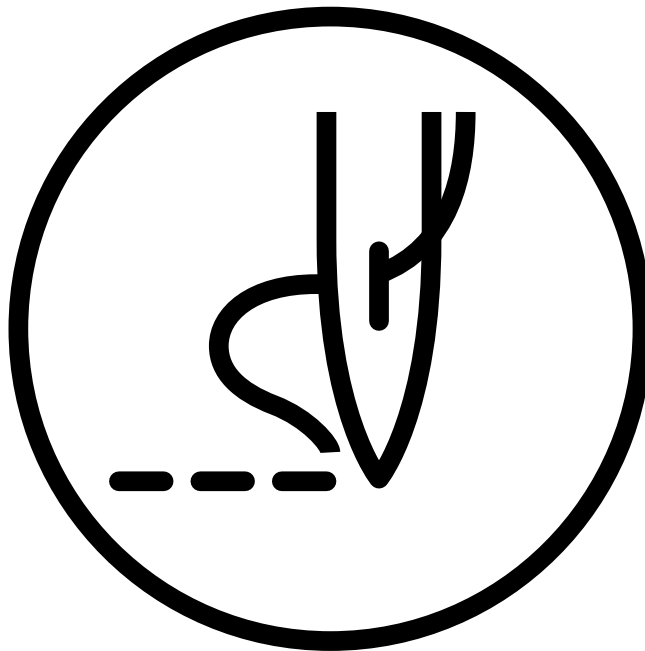

brother[®]

Precautions

- Unauthorized commercial or industrial use of trademarks or copyrighted materials (such as paintings, drawings, photos, logos, etc.) owned by other companies or persons is illegal. The use of such materials without the permission of their owners may result in criminal or civil liability.
- This manual may be subsequently modified without prior notice.
- Brother Industries, Ltd. shall assume no responsibility for any consequences of using this manual.

Thank you very much for buying a BROTHER sewing machine. Before using your new machine, please read the safety instructions below and the explanations given in the instruction manual.

With industrial sewing machines, it is normal to carry out work while positioned directly in front of moving parts such as the needle and thread take-up lever, and consequently there is always a danger of injury that can be caused by these parts. Follow the instructions from training personnel and instructors regarding safe and correct operation before operating the machine so that you will know how to use it correctly.

SAFETY INSTRUCTIONS

1 Safety indications and their meanings

This instruction manual and the indications and symbols that are used on the machine itself are provided in order to ensure safe operation of this machine and to prevent accidents and injury to yourself or other people. The meanings of these indications and symbols are given below.

Indications



DANGER

The instructions which follow this term indicate situations where failure to follow the instructions will almost certainly result in death or severe injury.



CAUTION

The instructions which follow this term indicate situations where failure to follow the instructions could cause injury when using the machine or physical damage to equipment and surroundings.

Symbols



..... This symbol () indicates something that you should be careful of.

The picture inside the triangle indicates the nature of the caution that must be taken. (For example, the symbol at left means "beware of injury".)



..... This symbol () indicates something that you must not do.



..... This symbol () indicates something that you must do.

The picture inside the circle indicates the nature of the thing that must be done. (For example, the symbol at left means "you must make the ground connection".)

2 Notes on safety

DANGER



Wait at least 5 minutes after turning off the power switch and disconnecting the power cord from the wall outlet before opening the face plate of the control box. Touching areas where high voltages are present can result in severe injury.

CAUTION

Environmental requirements



Use the sewing machine in an area which is free from sources of strong electrical noise such as high-frequency welders. Sources of strong electrical noise may cause problems with correct operation.



Any fluctuations in the power supply voltage should be within $\pm 10\%$ of the rated voltage for the machine. Voltage fluctuations which are greater than this may cause problems with correct operation.



The power supply capacity should be greater than the requirements for the sewing machine's electrical consumption. Insufficient power supply capacity may cause problems with correct operation.



The air supply should have a capacity greater than the machine air consumption. If air is not supplied sufficiently, a machine malfunction may occur.



The ambient temperature should be within the range of 5°C to 35°C during use. Temperatures which are lower or higher than this may cause problems with correct operation.



The relative humidity should be within the range of 45% to 85% during use, and no dew formation should occur in any devices. Excessively dry or humid environments and dew formation may cause problems with correct operation.



Avoid exposure to direct sunlight during use. Exposure to direct sunlight may cause problems with correct operation.



In the event of an electrical storm, turn off the power and disconnect the power cord from the wall outlet. Lightning may cause problems with correct operation.

Installation



Machine installation should only be carried out by a qualified technician.



Contact your Brother dealer or a qualified electrician for any electrical work that may need to be done.



The sewing machine weighs more than 195 kg. The installation should be carried out by two or more people.



Do not connect the power cord until installation is complete, otherwise the machine may operate if the start switch is pressed by mistake, which could result in injury.



Be sure to connect the ground. If the ground connection is not secure, you run a high risk of receiving a serious electric shock, and problems with correct operation may also occur.



When securing the cords, do not bend the cords excessively or fasten them too hard with staples, otherwise there is the danger that fire or electric shocks could occur.



Be sure to wear protective goggles and gloves when handling the lubricating oil or grease, so that no oil or grease gets into your eyes or onto your skin, otherwise inflammation can result. Furthermore, do not drink the oil or grease under any circumstances, as they can cause vomiting and diarrhoea. Keep the oil out of the reach of children.













Avoid setting up the sewing machine near sources of strong electrical noise such as high-frequency welding equipment. If this precaution is not taken, incorrect machine operation may result.





Secure the machine with the nuts when installing it so that it will not move by placing the leveling seat on the sound floor.

CAUTION







Sewing

-  This sewing machine should only be used by operators who have received the necessary training in safe use beforehand.
-  The sewing machine should not be used for any applications other than sewing.
-  Be sure to wear protective goggles when using the machine.
If goggles are not worn, there is the danger that if a needle breaks, parts of the broken needle may enter your eyes and injury may result.
-  Turn off the power switch at the following times, otherwise the machine may operate if the start switch is pressed by mistake, which could result in injury.
 - When threading the needle
 - When replacing the bobbin and needle
 - When not using the machine and when leaving the machine unattended
-  Do not get on the table.
Table may be damaged.
-  Secure the machine with the nuts when installing it so that it will not move by placing the leveling seat on the sound floor.
-  Attach all safety devices before using the sewing machine. If the machine is used without these devices attached, injury may result.
-  Do not touch any of the moving parts or press any objects against the machine while sewing, as this may result in personal injury or damage to the machine.
-  Do not touch the pulse motor and sewing machine bed section during operation or for 30 minutes after operation. Otherwise burns may result.
-  If an error occurs in machine operation, or if abnormal noises or smells are noticed, immediately turn off the power switch. Then contact your nearest Brother dealer or a qualified technician.
-  If the machine develops a problem, contact your nearest Brother dealer or a qualified technician.

Cleaning

-  Turn off the power switch before starting any cleaning work, otherwise the machine may operate if the start switch is pressed by mistake, which could result in injury.
-  Be sure to wear protective goggles and gloves when handling the lubricating oil or grease, so that no oil or grease gets into your eyes or onto your skin, otherwise inflammation can result. Furthermore, do not drink the oil or grease under any circumstances, as they can cause vomiting and diarrhoea.
Keep the oil out of the reach of children.

Maintenance and inspection

-  Maintenance and inspection of the sewing machine should only be carried out by a qualified technician.
-  Ask your Brother dealer or a qualified electrician to carry out any maintenance and inspection of the electrical system.
-  Turn off the power switch and disconnect the power cord from the wall outlet at the following times, otherwise the machine may operate if the treadle is depressed by mistake, which could result in injury.
 - When carrying out inspection, adjustment and maintenance
 - When replacing consumable parts such as the rotary hook and knife.
-  If the power switch needs to be left on when carrying out some adjustment, be extremely careful to observe all safety precautions.
-  Use only the proper replacement parts as specified by Brother.
-  If any safety devices have been removed, be absolutely sure to re-install them to their original positions and check that they operate correctly before using the machine.
-  Any problems in machine operation which result from unauthorized modifications to the machine will not be covered by the warranty.

3 Warning labels

* The following warning labels appear on the sewing machine.
Please follow the instructions on the labels at all times when using the machine. If the labels have been removed or are difficult to read, please contact your nearest Brother dealer.

1

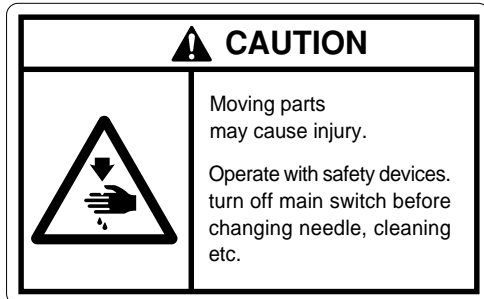

Safety devices: Finger guard, Belt cover, etc.

2

	DANGER	GEFAHR	DANGER	PELIGRO
	Hazardous voltage will cause injury. Turn off main switch and unplug power cord before opening this cover.	Hochspannung verletzungsgefahr! Vor Öffnen des Gehäuses Hauptschalter ausschalten und Netzstecker ziehen!	Un voltage non adapté provoque des blessures. Pour ouvrir cette plaque, couper le contact general de la machine et debrancher le cable d'alimentation.	Un voltaje inadecuado puede provocar las heridas. Antes de abrir esta tapa, desconecte la máquina y desenchufela de la red.

3



Never touch or push the needle bar during operation as it may result in injuries or damage to the sewing machine.

4

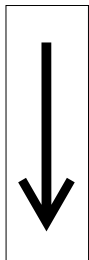

Direction of operation

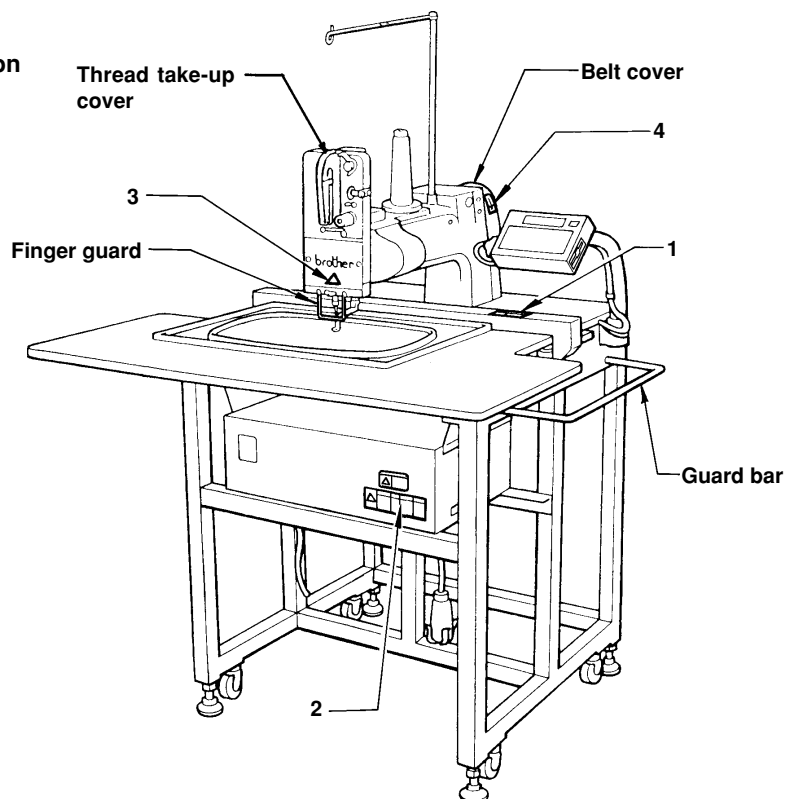

Before Starting Operation

Do not force open the shutter for direct contact with the magnetic area.



Do not bring disks near magnetic matters such as magnetic screwdriver or the back side of the programmer.

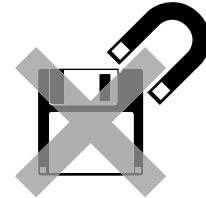

Do not store floppy disks in an extremely high or low ambient temperature.

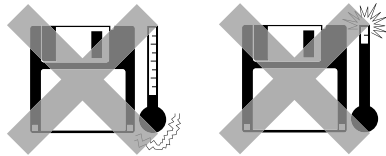

Do not use floppy disks under high humidity.



Do not use or store floppy disks in a dusty place.
Do not place it on cloth.

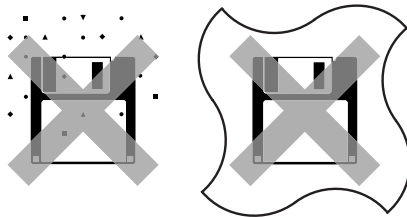

Do not store floppy disks under direct sunlight.

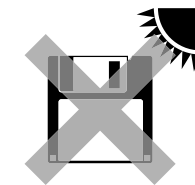

Do not bend the disk. Do not put things on the disk.



Avoid contact with solvent or drink.



Store it in the case immediately after using it to protect it from dust and damage.

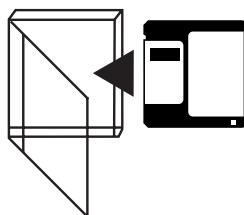

Use a commercially available cleaning disk to clean the head of the floppy disk drive periodically.



Do not remove the disk out of the drive during the access lamp is lit.

Protecting data in floppy disks

Write-protection is available for a floppy disk to prevent undesired data deletion. A write-protected disk is read-only. It is recommended to provide write-protection for disks which contain important data.

To do so, slide the write-protect notch to open the slot as shown below.

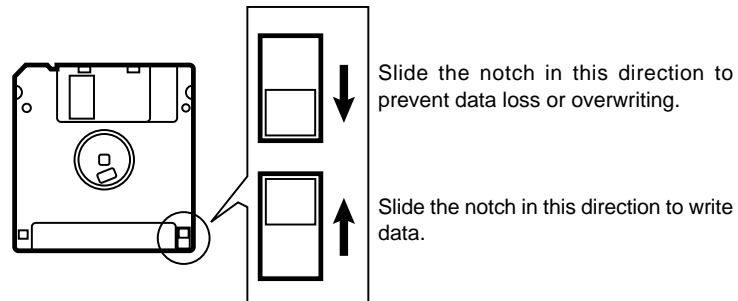

Procedure of Reading This Manual

This manual consists of the following chapters:

Chapter 1 Preparation of Embroidery Machine

This Chapter describes the specifications, installation and preparatory procedures of starting up the machine.

Chapter 2 Embroidering Procedures

Provides explanations on the operation panel and briefly reviews the flow of embroidering processes.

Chapter 3 Selection of Data and Embroidering

This Chapter describes procedures of reading sewing data and sewing.

Chapter 4 Editing of Embroidering Data

Explains how to edit the embroidery data.

Chapter 5 Setting

This Chapter describes procedures of setting the machine and working environment.

Chapter 6 Operation of Machine

Provides information on machine operation during embroidering.

Chapter 7 Maintenance

Describes appropriate maintenance of the machine.

Chapter 8 Adjustment

Explains how to adjust the needles.

Chapter 9 List of Error Messages

Provides information on error codes and action to be taken.

Chapter 10 Troubleshooting

Provides troubleshooting for the machine.

Connection and Installation of Optional Equipment

Describes connections between the machine/computer and optional equipment available.

Screen Composition

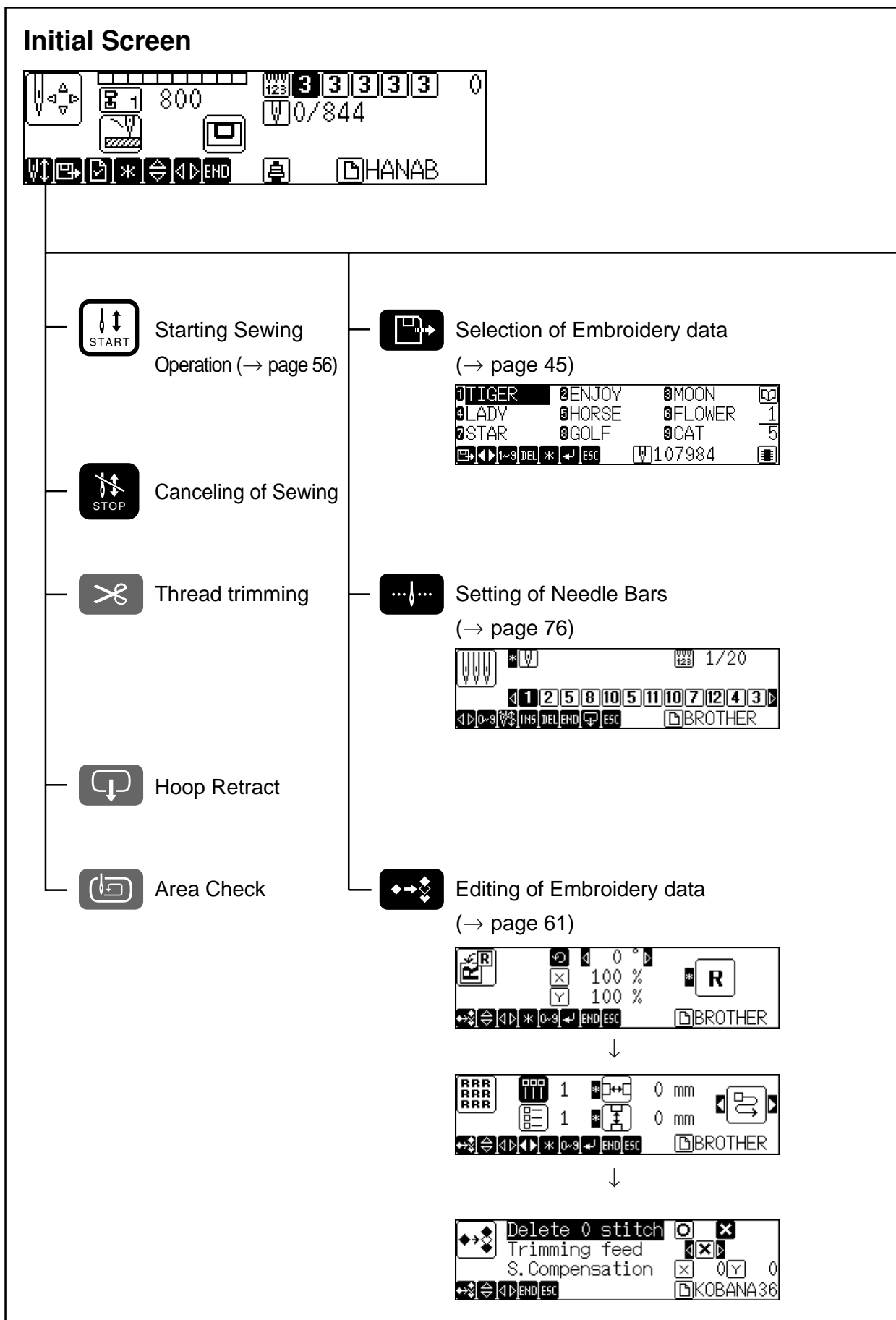



Setting of thread breakage sensor (→ page 78)

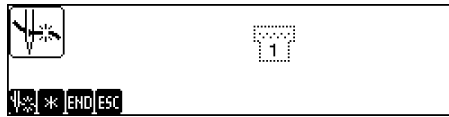

Setting of Machine (→ page 81)

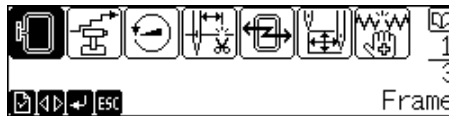

Contents

SAFETY INSTRUCTIONS	1
Before Starting Operation	5
Procedure of Reading This Manual	7
Screen Composition	8

Chapter 1 Preparation of Embroidery Machine

1. Specifications	16
2. Names of Machine Components	17
3. Installation	18
3-1 Transportation of Machine	18
3-2 Installation of Machine	18
3-3 Installation of Operation Panel	19
3-4 Attaching the lead guide bar and the thread guide	19
3-5 Mounting of Guard Bar	19
3-6 Attaching the 9-spool cotton stand (optional)	20
3-7 Bobbin winder (optional)	21
4. Preparation for Embroidering	23
4-1 Upper Threading	23
4-2 Replacement of Bobbin	24
4-3 Replacing and Selecting Needle	25
4-4 Connection to Power Source	26
4-5 Preparation of Machine for Operation	26
4-6 Attachment of Embroidery Hoop and Frame	29
4-7 Adjustment of Thread Tension	33

Chapter 2 Embroidering Procedures

Functions of Operation Panel	36
Operation Panel	36
Shut-off switch unit	39
Stop switch unit	39
Flowchart of Preparation for Embroidering	40
Turn on the Machine Power	41
Retrieve the Embroidery Data	42
Start Embroidering	42

Chapter 3 Selection of Data and Embroidering

What Can the Machine Do?	44
Selection of Data	45
Registration of Embroidery Data from Floppy Disk	45

Reading from Memory	48
Registration of Embroidery Data from BE-100	49
Deletion of Embroidery Data from Machine Memory	50
Modification of Embroidery Data Name	52
Sewing Operation	56
Before Starting Sewing	56
Starting Sewing Operation	56
Feedhold and Cancellation of Sewing	57
Step Forward and Step-Back	58
Step Forward/Step-Back Mode	58
Setting Amount or Timing of Step Forward/Step-Back	58
For Step Forward (Back)	59
Resuming Sewing	59
Writing the embroidering data	60

Chapter 4 Editing of Embroidering Data

What Can the Machine Do?	62
Rotation	63
Enlargement and Reduction	64
Mirror	66
Repetition	68
Other Editing	70

Chapter 5 Setting

What Can the Machine Do?	74
Setting of Needle Bars	76
Thread Breakage Sensor	78
Setting of sensor validity/invalidity	78
Thread Breakage Sensitivity	78
Automatic Step-Back	79
Setting of Lower Thread Counter/Stitch Counter	80
Setting of Machine	81
Embroidery Hoop	81
Speed Range	82
Speed of Each Speed Range	83
Setting of Mending	84
Thread Trimming Length	84
Thread Withdrawal Feed Length	85
Inching	86

Sewing Area	87
Registration of Sewing Start Position	88
Hoop Retract Point	88
Hoop Automatic Retract	89
Movement to Registered Sewing Start Point	89
Setting of Environment	90
Return to Start Point	90
Speed Range	90
Checking the Embroidery Area	91
Feed rate adjustment	92
Setting of RS-232C Communication Speed	92
Display Language	93
Alarm Sound	94
Motive Speed	95
Small-Pitch Deletion	96
XY Feed Power Increase	97
Boring	98
Lock Stitch	99
Speed Limit in a Short Pitch	102
Feed Timing	103
Automatic Input Setting	104
Display of Information	107
Pattern Information	107
Features of Machine	108
Information about Versions	109

Chapter 6 Operation of Machine

1. Operating Procedures	112
1-1 Power Source	112
1-2 Preparation for Embroidering	112
2. Machine Stop	113
2-1 Stopping the Machine with the stop switch unit	113
2-2 Emergency Stop of the Machine with the shut-off switch unit	113
3. Hoop Feed Position	114
4. Area Check	115
4-1 External Tracing	115
4-2 Automatic Hoop Movement in Area	115
5. Jog Switches	116
5-1 Hoop Movement to Start Position	116
5-2 Inching Mode during Embroidering (Forcible Hoop Movement)	117
6. Detection of Home Position	118

Chapter 7 Maintenance

1. Cleaning	120
1-1 Cleaning and Lubrication of Rotary Hook	120
1-2 Cleaning of Needle Plate	121
2. Oiling	122
2-1 Head	122

Chapter 8 Adjustment

1. Adjusting Needle Bar Height	126
2. Adjustment of Timing Between Needle and Rotary Hook	130
3. Adjustment of Presser Foot Height	131
4. Adjustment of Thread Trimmer	132
5. Adjusting the Belt Tension	133

Chapter 9 Error code list

Chapter 10 Troubleshooting

Mechanical Section	140
Electrical Section	142

Connection and Installation of Optional Equipment

Attaching Bobbin Winder (Using the 9-spool cotton stand)	148
---	------------



Chapter 1

Preparation of Embroidery Machine

1. Specifications

Embroidery machine used	1 needle embroidery machine head
Application	Pattern embroidery
Sewing speed	Maximum 1200 rpm
Sewing area	Max. 300 (V) x 450 (H) mm (flat hoop area) 85 (V) x 360 (H) mm (with cap frame)
Feed system	By pulse motor wire drive
Stitch length	0.1 ~ 12.7 mm (minimum pitch: 0.1 mm)
Storage medium	3.5 2DD floppy disk (Tajima format) 3.5 2HD floppy disk (the equivalent to Tajima format) 3.5 2DD floppy disk (Barudan FDR/FMC format) (embroidary data in FDR35III/V format only) 3.5 2DD floppy disk (ZSK format) 3.5 floppy disk (brother ECS format)
Thread trimming	Automatic thread trimmer
Needle thread breakage	Needle thread breakage detector
Power supply	Single phase 120 V, 200 V, 220 V, 240 V, Standard 400 W (maximum 500 W)
Weight	195 kg
Dimensions	1050 (W) x 1016 (L) x 1484 (H) mm
Options	Embroidery hoops in different sizes, Bobbin winder, Cap frame device, Cotton stand 9

2. Names of Machine Components

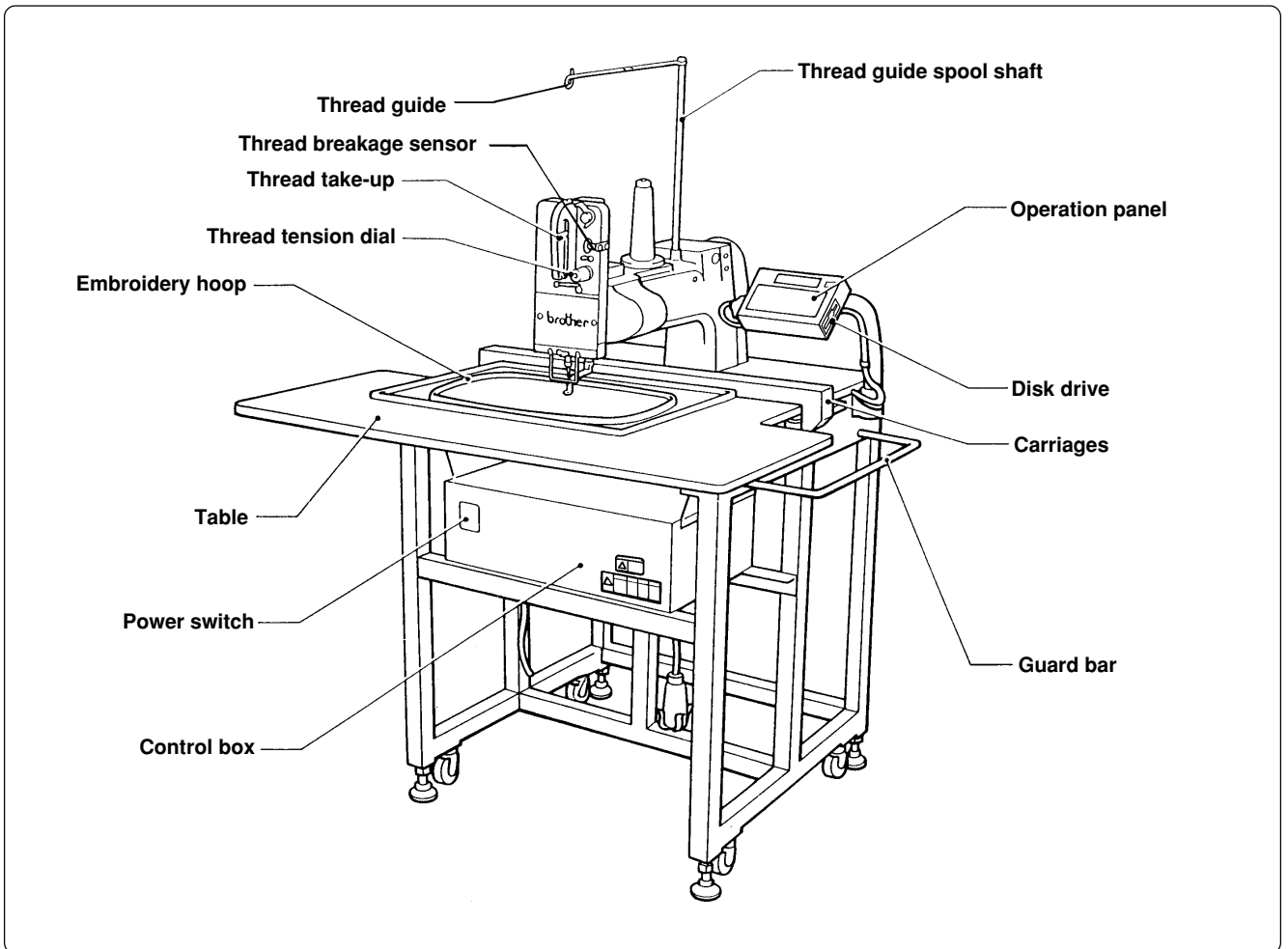

3. Installation

⚠ DANGER

- | | |
|---|--|
| <ul style="list-style-type: none"> ⊘ Embroidery machines should be installed only by trained engineers. ⚠ Electric wiring should be laid by your distributor or electric experts. ⚠ The sewing machine weighs more than 195 kg. The installation should be carried out by two or more people. ⊘ Do not connect the power source until installation is completed. Doing so may start the machine unintentionally through an accidental activation of the START switch, resulting in bodily injuries. | <ul style="list-style-type: none"> ⚠ Install a machine in a place away from a high-frequency welding machine or other machines that may generate a strong electric noise. Failure to do so may cause the embroidery machine to malfunction. ⚠ Be sure to connect the ground. If the ground connection is not secure, you run a high risk of receiving a serious electric shock, and problems with correct operation may also occur. ⚠ Secure the machine with the nuts when installing it so that it will not move by placing the leveling seat on the sound floor. |
|---|--|

- * After installation is completed, get the power supply from a dedicated outlet.
- * When connecting multiple machines, exercise care not to exceed the capacity of the outlet.

3-1 Transportation of Machine

When relocating the machine, lift it by the steel frame.

Note) Never lift the machine by the table or the guard bar.

3-2 Installation of Machine

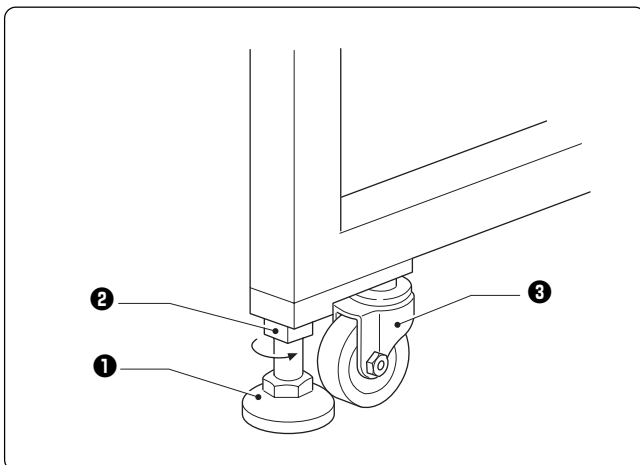

1. Adjust leveling seats ① by turning nuts ② in the direction of the arrow until the table top is placed horizontally.
2. If the table is not stable, loosen nuts ② and turn leveling seats ① for adjustment.

When relocating the machine, raise leveling seats ①. The machine can then be moved with casters ③.

3-3 Installation of Operation Panel

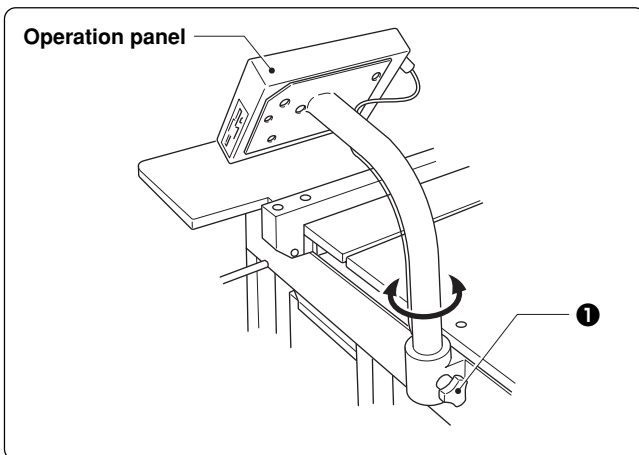

Loosen thumb bolt ❶. Adjust the operation panel position for ease of use, and tighten thumb bolt ❶.

3-4 Attaching the thread guide bar and the thread guide

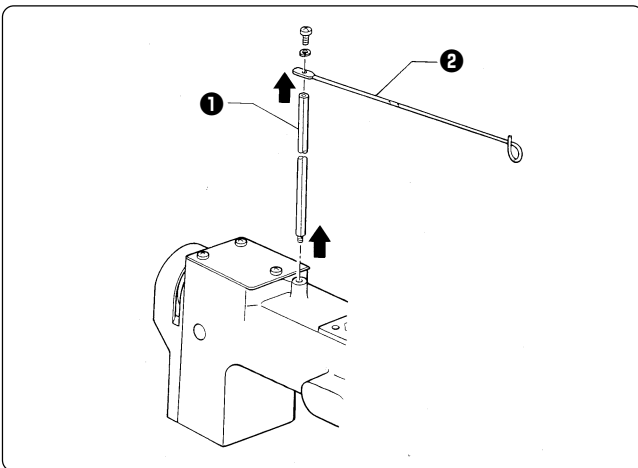

1. Insert the thread guide bar ❶ from the top of the machine head by turning it.
2. Attach the thread guide ❶ to the thread guide bar ❷ using the screw.

3-5 Mounting of Guard Bar

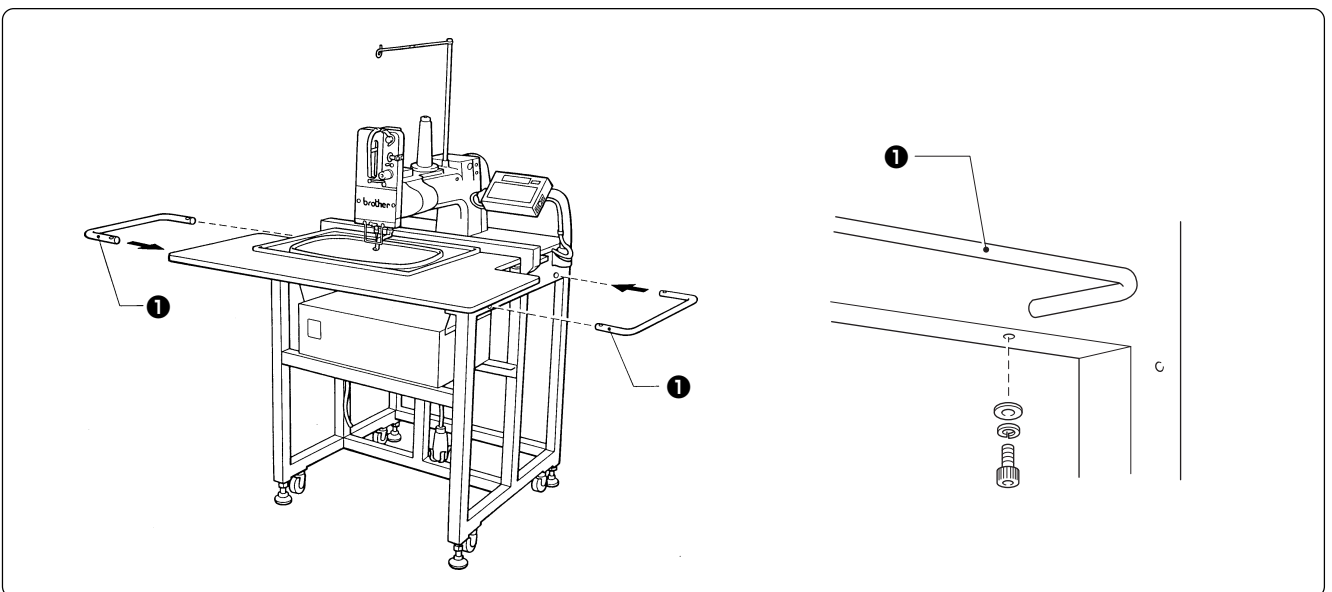

Attach guard bar ❶ to the machine. Fix it with bolts, flat washer and spring washer from the lower side of the frame.

3-6 Attaching the 9-spool cotton stand (optional)

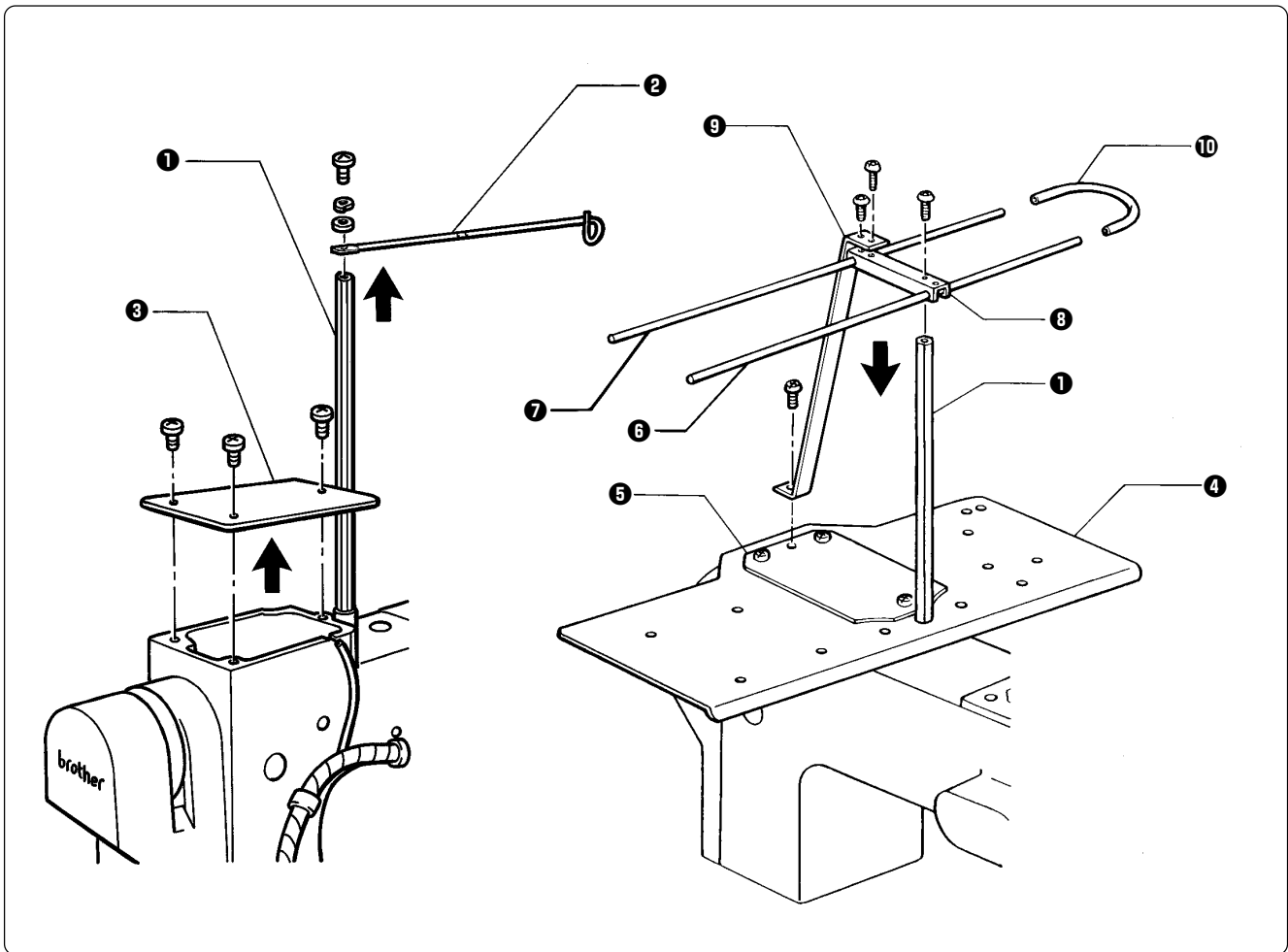

1. Remove the screw and the thread guide ❷ from the thread guide bar ❶.
2. Remove the screws and arm cover (R) ❸ from the machine head.
3. Insert the thread guide bar ❶ into the hole of cotton stand (L) ❹, and attach it to the machine head using the two screws.
4. Place cotton stand (S) ❺ on cotton stand (L) ❹ and tighten the screw.
5. Attach thread guides (A) ❻ and (B) ❼, and the thread guide joint ❸ to the thread guide bar ❶, and secure them using the screw.
6. Attach the guide plate ❾ to the thread guide joint ❸ and cotton stands (S) ❺ and (L) ❹ using the screws.
7. Attach the vinyl tube ❿ to thread guides (A) ❻ and (B) ❼.

3-7 Bobbin winder (optional)

■ Attaching bobbin winder

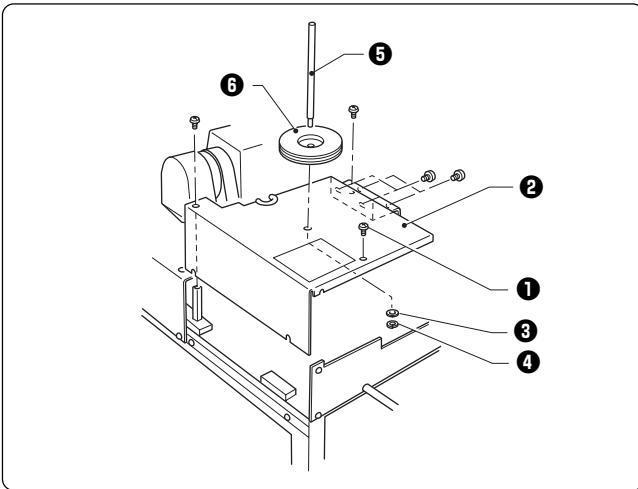

1. Loosen the eight screws ① and remove table (L) ②.
2. Attach spool shaft ⑤ to table (L) ② with the washer ③ and the nut ④.
3. Attach table (L) ② to the machine body with the eight screws ①.
4. Pass spool mat ⑥ through spool shaft ⑤.

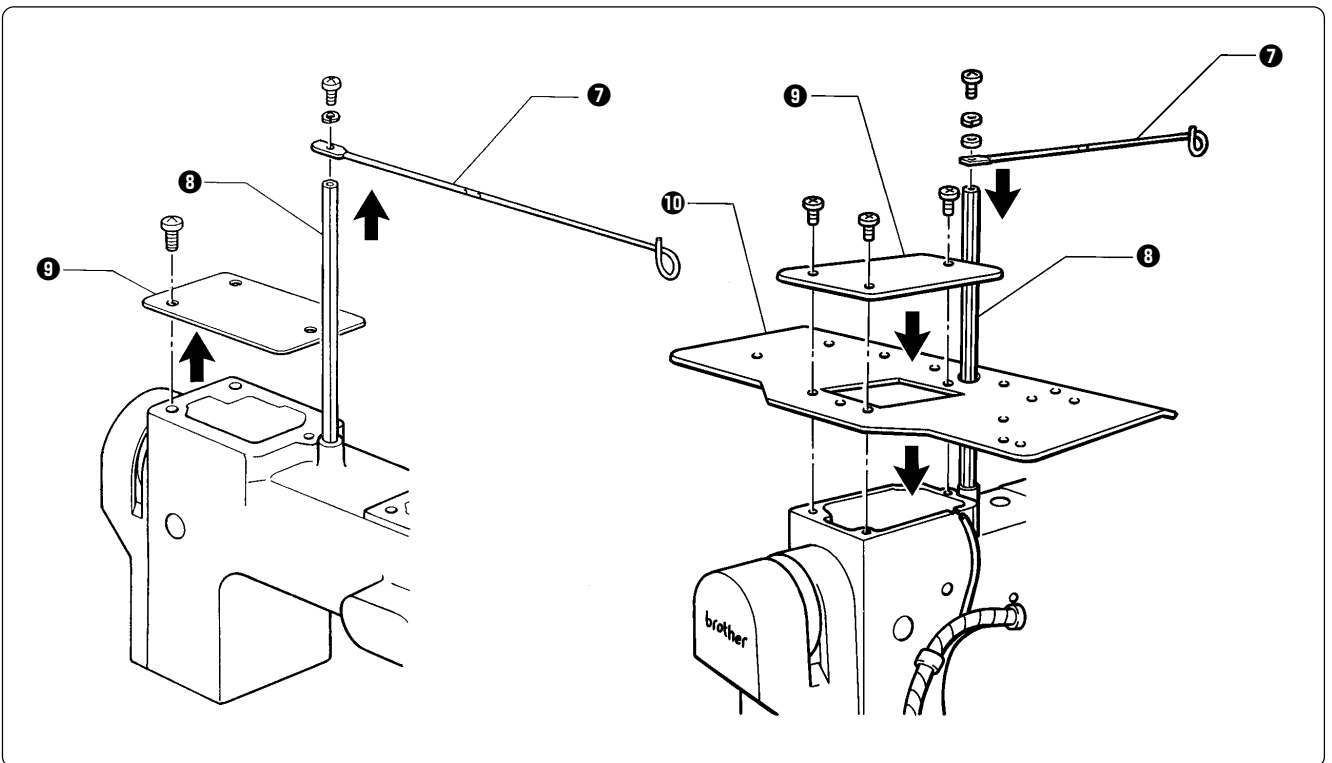

5. Remove the thread guide screw, and then remove the thread guide ⑦ from the thread guide bar ⑧.
6. Remove the screws, and arm cover (R) ⑨ from the machine head.
7. Install the accessory cotton stand (L) ⑩ with the screws, and then install it together with the arm cover (R) ⑨.
8. Install the thread guide bar ⑧ and the thread guide ⑦.

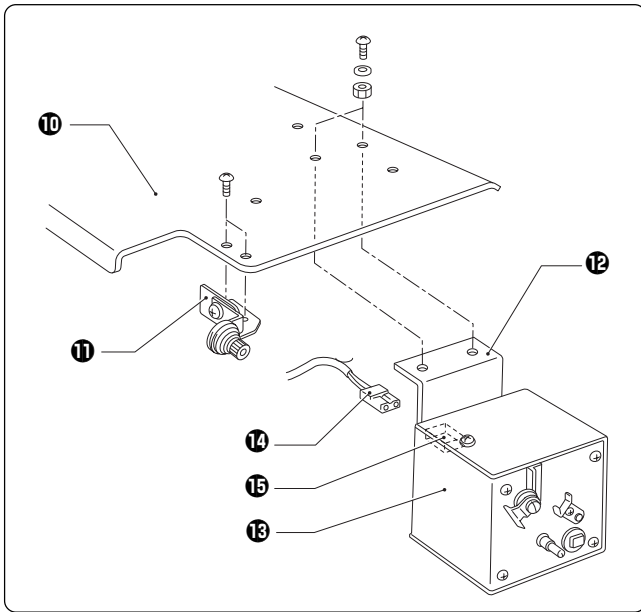

9. Attach the bobbin winder guide bracket assembly ⑪ to the spool stand (L) ⑩ with the screws.

10. Attach the bobbin winder equipment assembly ⑬ with bobbin winder plate ⑫ to the machine body with the two bolts, and then connect the bobbin winder equipment connector ⑮ to the nylon connector ⑭.

■ Winding bobbin thread

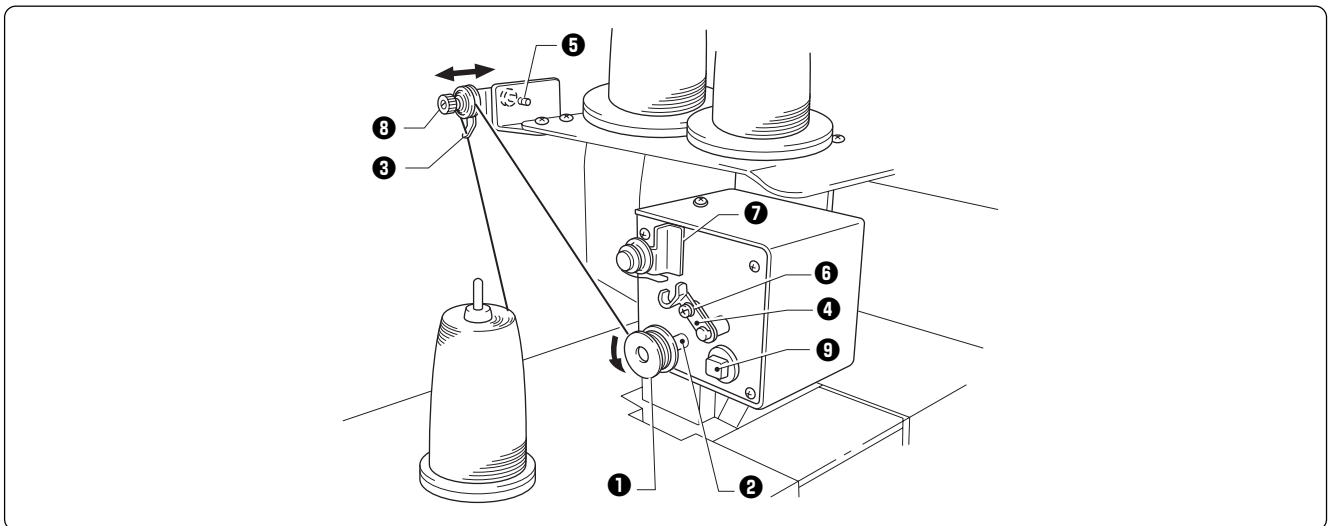

1. Turn on the machine power switch.

2. Press the bobbin ① on the bobbin winder shaft ②.

3. Pass the thread through the thread guide ③.

4. Wind the thread on the bobbin ① several times in the direction of the arrow.

5. Press the bobbin presser ④.

NOTE) If the thread is not wound evenly on the bobbin, loosen the screw ⑤ and move the thread guide ③ right and left. When winding more thread on the bobbin, loosen the screw ⑥, then move the bobbin presser ④.

6. When the winding is finished, remove the bobbin from the bobbin winder shaft and trim the thread with the thread trimmer ⑦.

NOTE) • If the thread comes out from the thread guide ③, loosen the knob ⑧. If the thread is wound too loose, tighten the knob ⑧.

• The thread winder motor does not operate if the circuit protector activated. In that case, leave the protector until it's cooled off. Then, press the protector switch ⑨. (If the protector is not cooled off, the switch does not work.)

4. Preparation for Embroidering

⚠ CAUTION



Turn off the power switch before starting preparation.

Failure to do so may start the machine unintentionally through an accidental activation of the START switch, resulting in bodily injuries.

4-1 Upper Threading

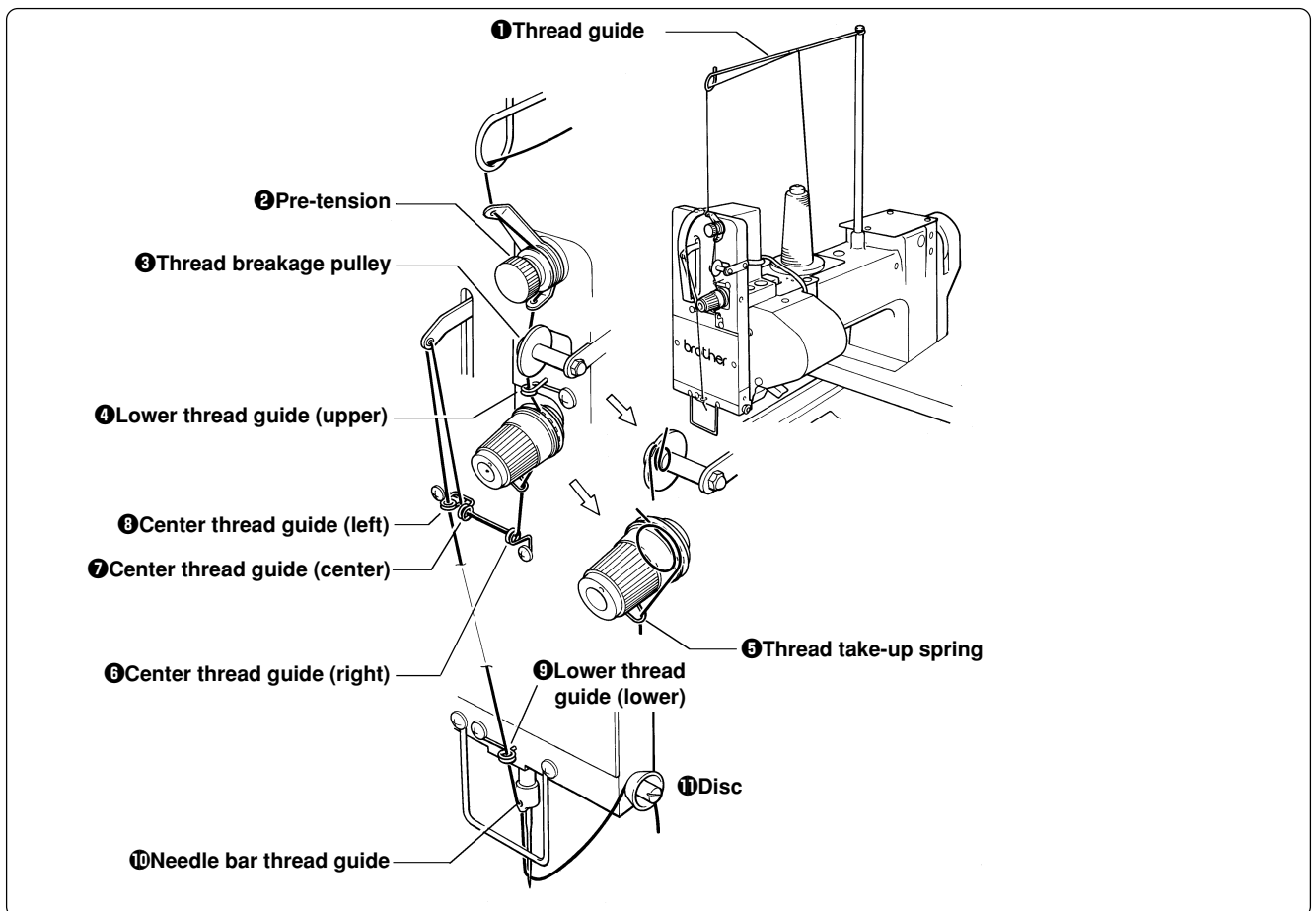

1. Pass the needle thread from the cotton stand through the two loops in the thread guide **1** from right to left.
2. Pass the thread through the thread guide of the pre-tension **2**. Then open the thread guide plate with your finger so that the thread passes through correctly, and then pass the thread through the hole at the bottom of the thread guide.
3. Wind the thread twice around the pulley of the thread breakage sensor **3**, starting from the front of the pulley, and then pass the thread through the lower thread guide (upper) **4**.
4. Wind the thread once to the right between the rotary tension discs and then hook it onto the thread take-up spring **5**.
5. Hook the thread onto the center thread guides (right **6** and center **7**), pass it through the thread take-up lever, and then pass it once more through the center thread guide (left) **8**.
6. Pass the thread through the lower thread guide (lower) **9**, hook it onto the needle bar thread guide **10**, then pass it through the needle eye and hook it onto the disc **10**.

4-2 Replacement of Bobbin

Note) Remove dust, lint and oil from the bobbin case before replacement.

■ Removing bobbin case

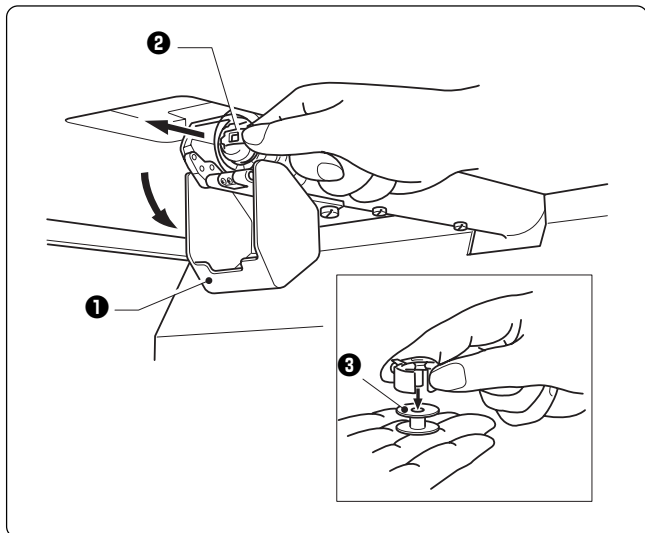

1. Open the rotary hook cover ❶.
2. Hold the knob ❷ and take out the bobbin case.
3. Close the knob and take out the bobbin ❸.

■ Replacing bobbin

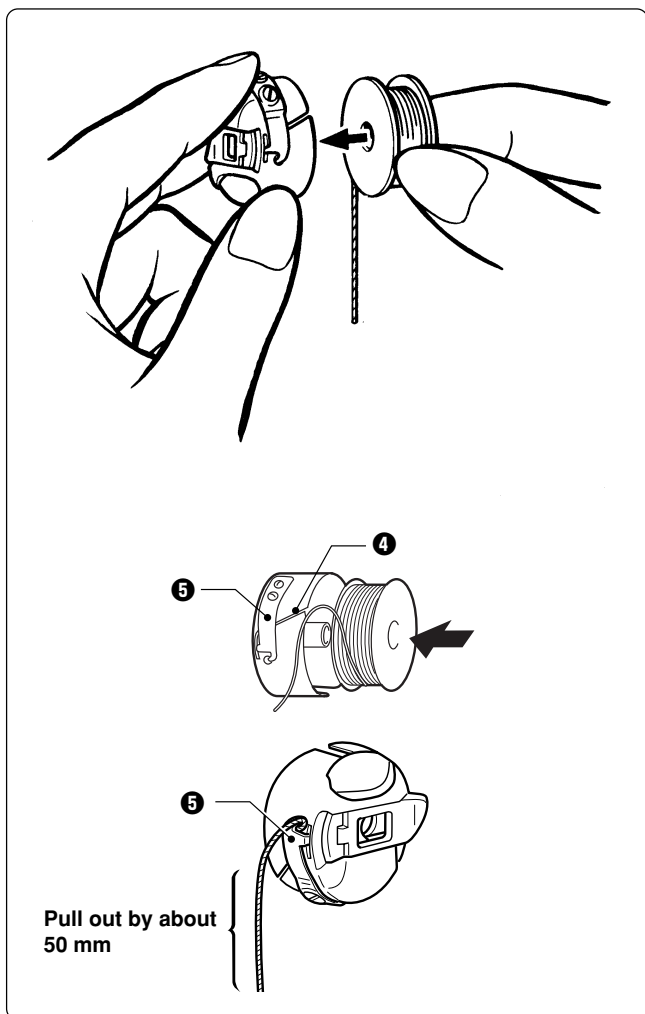

1. Put a new bobbin in the bobbin case.

Check the winding direction. (refer the figure)

If the bobbin is inserted in the reverse direction, the lower thread may slip too much, resulting in a problem in embroidering.

Check that the bobbin is pushed out of the bobbin case by about 0.5 mm. If not, the slip prevention spring of the bobbin case does not work. Adjust the height of the spring or replace it with a new one.

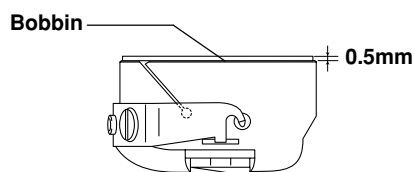

2. Slide the thread under the tension spring ❺ through the notch ❹.
3. Pull out the thread from the hole of the tension spring ❺.
4. Pull out the thread by about 50 mm.

■ Attaching bobbin case

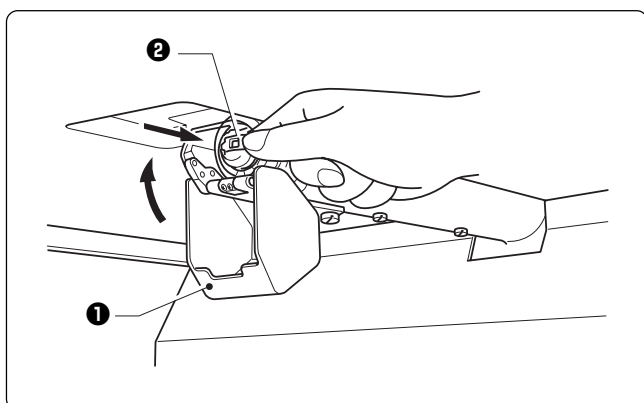

1. Hold the knob ② and attach the bobbin case securely.
2. Close the rotary hook cover ①.

4-3 Replacing and Selecting Needle

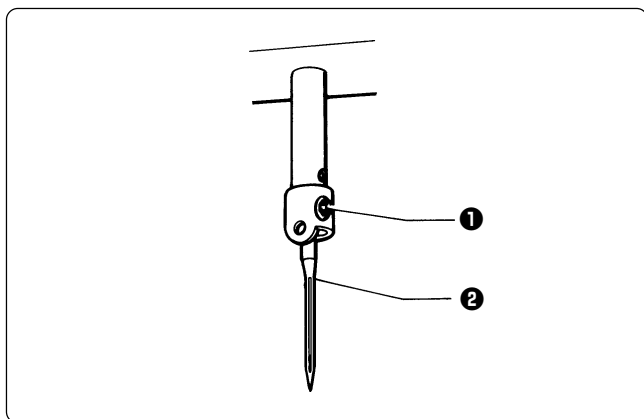

■ Removing needle

Loosen the set screw ① and remove the needle ②.

■ Attaching needle

With the flat side facing the front, insert the needle all the way until it meets the end of the needle bar. Tighten the set screw ① firmly.

- Note)
- Set the needle so that the notched part will come on the rotary hook side.
 - The needle eye should not be angled to the left (when viewed from the front).

* Relationship between materials and needles

Material	Needle	Needle thickness
Denim Leather	DB x K5	#14, #16, #18
Handkerchief		#9, #10
Shirt Towel		#11, #12, #13

■ Selecting needle

- When using special threads such as gold, silver, and rame yarn, use a heavy-duty needle (#11 ~ #16). For better finish, paste the waxed paper on the back of the material.
- In general, use DBxK5 #11 ~ #18 according to the material thickness. For knitted materials, use DBxK23 #11 because its rounded point prevents the knit thread from breaking.

4-4 Connection to Power Source

⚠ DANGER



Be sure to connect an earth cable.
Failure to do so may result in electric shock.

Use a cord plug that matches the receptacle type.

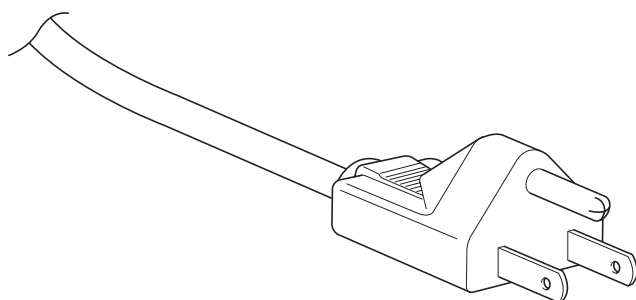

4-5 Preparation of Machine for Operation

■ Check the following before turning on the power

Thread	(1) Is upper thread setting complete? (3) Is thread passed through needle?	(2) Is the thread passed smoothly? (4) Is the lower thread setting complete?
Embroidery hoop	(1) Is there any looseness in the material?	(2) Is the hoop clamped securely?
Needle stop position	(1) Is thread take-up positioned correctly?	(2) Is needle bar positioned at the top?

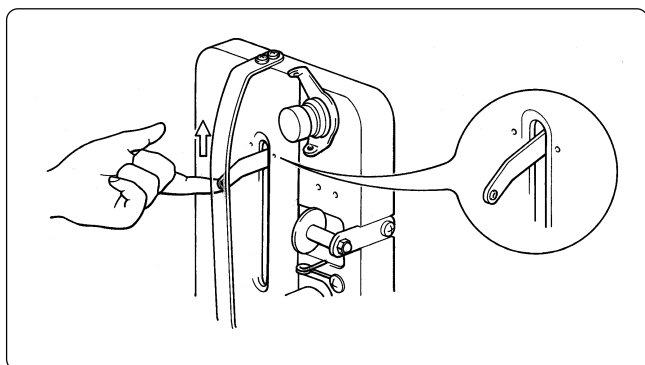

Check that the thread take-up lever is aligned with the index mark.

Turning on the power switch brings up the message "Moving frame" and sounds a beep as a warning. Then, the X and Y carriages move the embroidery hoop to the home position or the position where it was located at the end of the previous operation. Check that there is no obstacle above the hoop which will interfere with needle or presser foot.

■ When the machine is turned on:

If the machine is not ready to operate because the needle bars in the drive position are out of the normal position, the message "Needle stop position error" appears. Follow the steps below if this occurs.

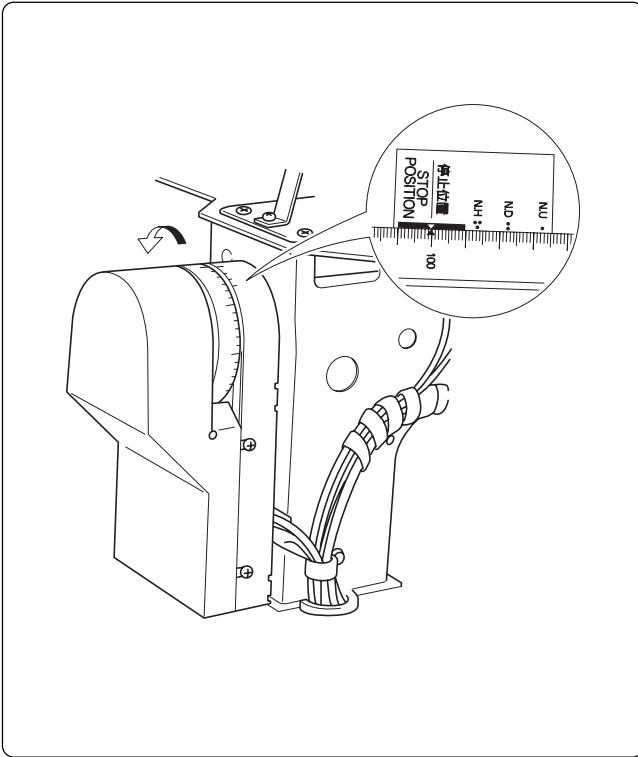

1. Set "100° (→)" on the pulley to "STOP POSITION."

2. Press .

Note) Check if the needle bars are lowered. If so, return them to the normal stop position. (Refer to "Normal needle stop position" on page 27.)

3. The message "Moving frame" appears and a buzzer sounds four times. The X and Y carriages move automatically so as to bring the hoop center to the home position or to the position where it was located at the end of the previous operation.

4. The main menu appears.

■ Normal needle stop position

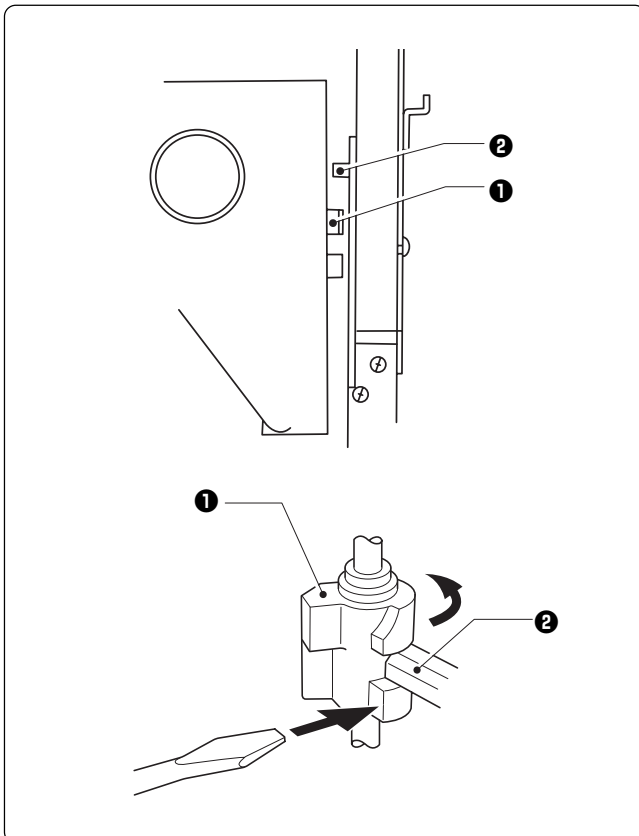

Viewing the inside through the clearance, needle bar is in the jump position at the top (as shown in the figure) and needle bar vertical piece ① lowers to keep it from contact with needle bar clamp ②. (The thread take-up lever is aligned with the index mark.)



Note) When the power switch has been turned on or when restarting embroidering while the machine is stopped or suspended, be sure to return the needles to the normal stop position.

- Align thread take-up to the normal position.
- If the needle bar in the embroidering position is lowered with needle bar vertical piece ①, separate them in the following manner. For safety, insert a tool such as a screwdriver into the clearance at the front left side of the needle bar case and turn the needle bar vertical piece ② by pushing its end. When the needle bar and the needle bar vertical piece are separated, the needle bar is raised to the top by the spring.

■ Clearing internal memory

Internal memory can be reset to the status before shipment.

Follow the steps below to clear memory:

1. Turn off the machine power switch.
2. Hold down , and turn on the power switch.
3. Press .

When  is pressed, only the embroidery data is cleared. Therefore, other setting data is saved.

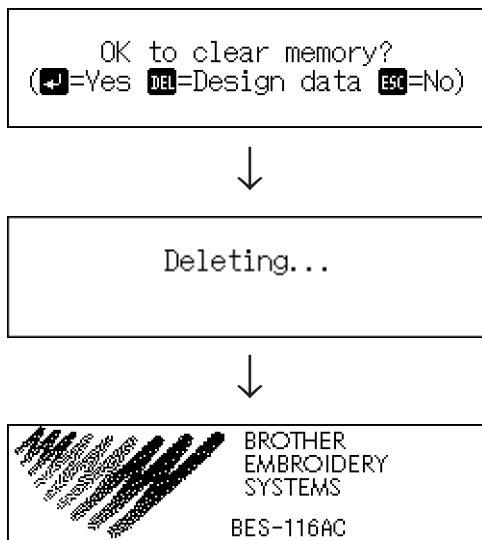

4. Memory has been cleared.

4-6 Attachment of Embroidery Hoop and Frame

■ Attaching a square frame and a flat hoop frame (standard)

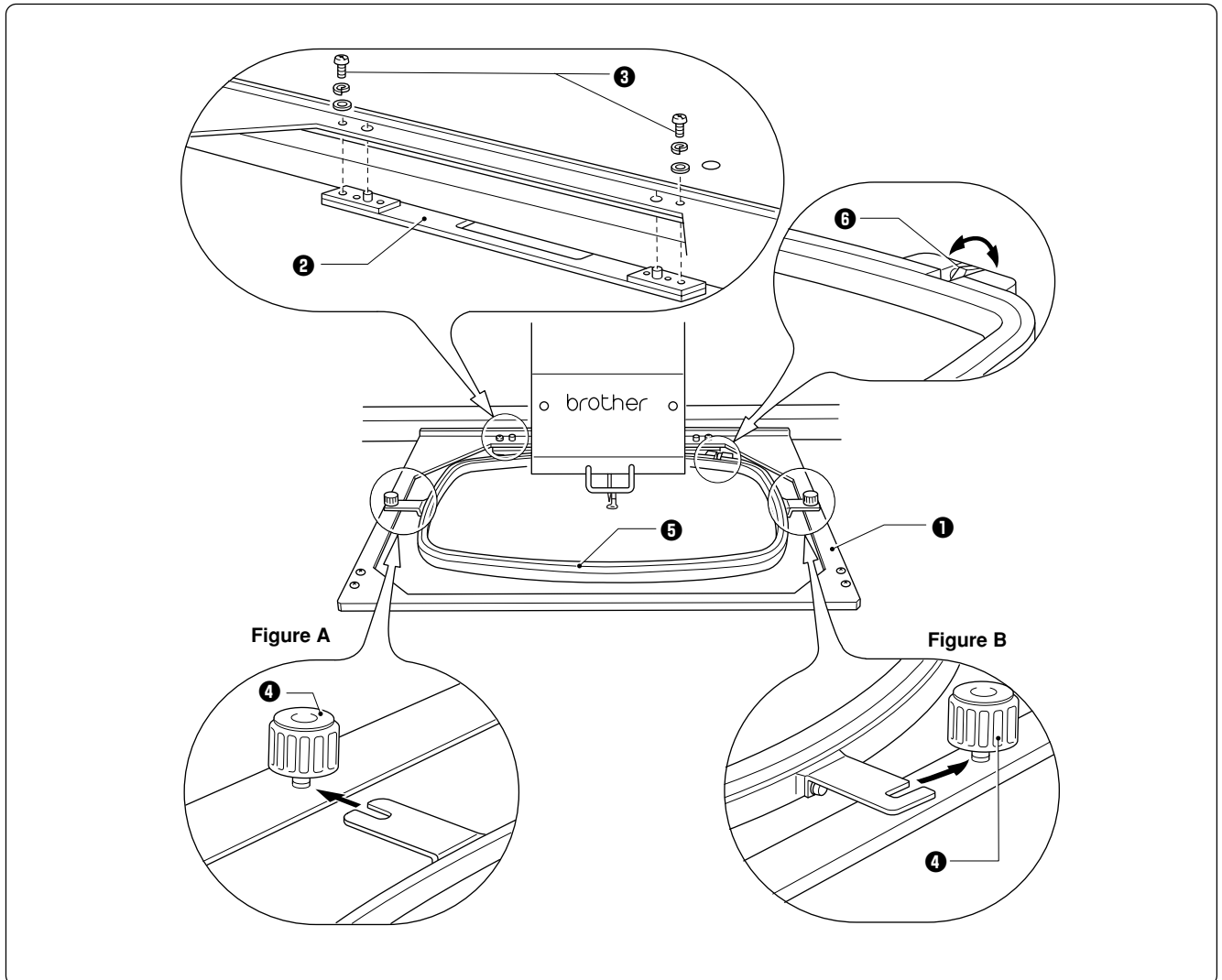

1. **Attach flat hoop frame (assembly) ① to X carriage ②, and tighten two screws ③.**
Fit the projections of the X carriage into the inner holes.
2. **Loosen two screws ④. Attach square frame ⑤.**
3. **As shown in Figure A, fit the left metal part of the square frame to the screw. As shown in Figure B, fit the right metal part to the screw. Tighten two screws ④ securely.**
4. **If the material over the square frame is not set properly, stitches may be skipped, threads may be broken, or the material may shrink during embroidering. Make an adjustment using screw ⑥.**

■ Attaching a tubular round frame (optional)

Note) When using a tubular round frame with the frame for it, remove table from the machine.

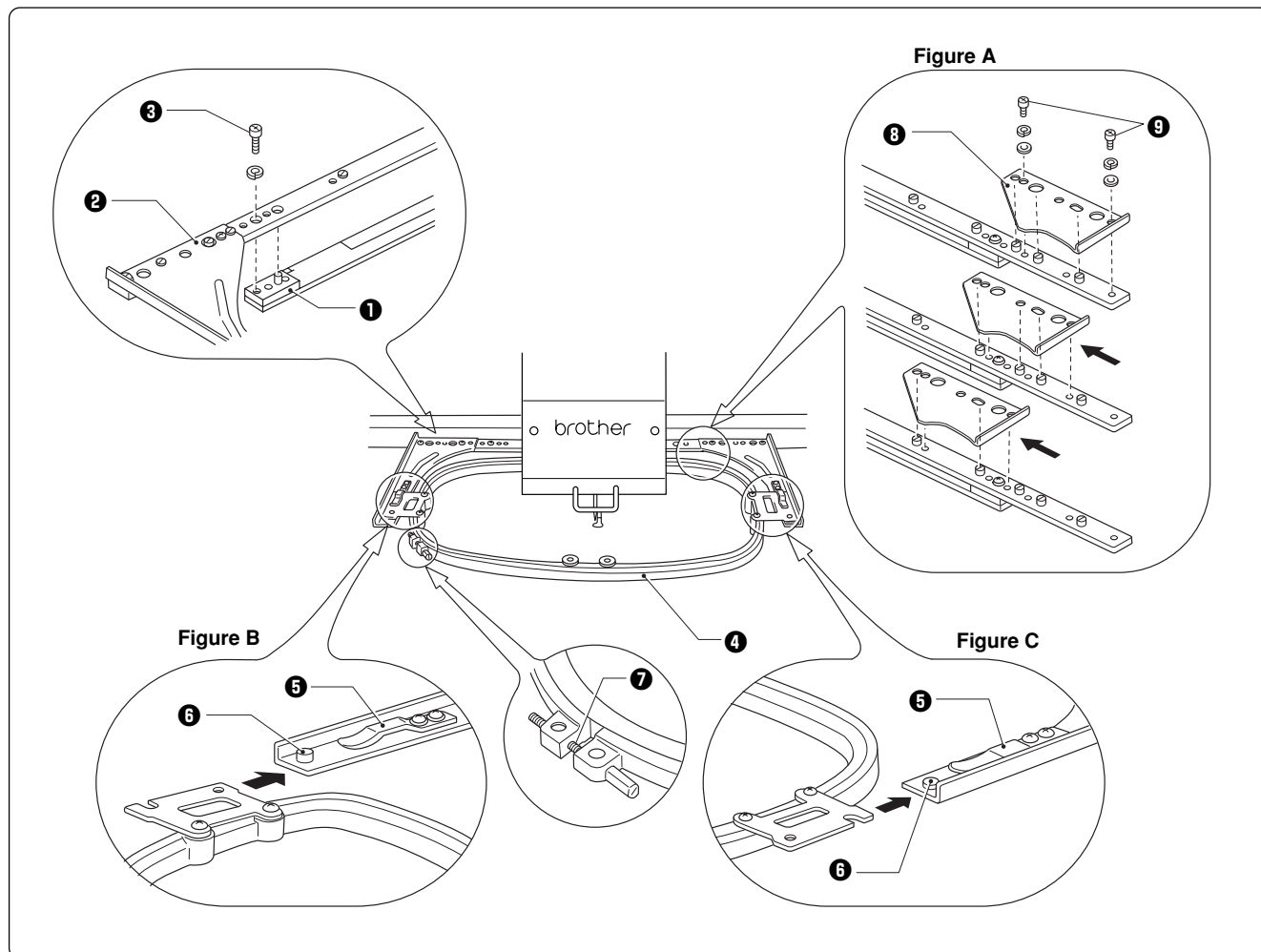

1. Attach two frame sets ② for tubular round frame to X carriage ① with two screws ③.
Fit the projections of the X carriage into the inner holes.
2. As Figures B and C show, while pushing up plate springs ⑤, insert the right and left metal parts of tubular round frame ④ and fit projections ⑥ into the hole of the tubular round frame.
3. If the material over the tubular round frame is not set properly, stitches may be skipped, threads may be broken, or the material may shrink during embroidering. Make an adjustment using screw ⑦.
4. Remove screw ⑨ in Figure A. Position frame arms ⑧ R and L for the tubular round frame according to the mounting pitch of the tubular round frame, and attach the arms.
Note) Attach the frame arms R and L symmetrically.

■ Attaching a sash frame set (optional)

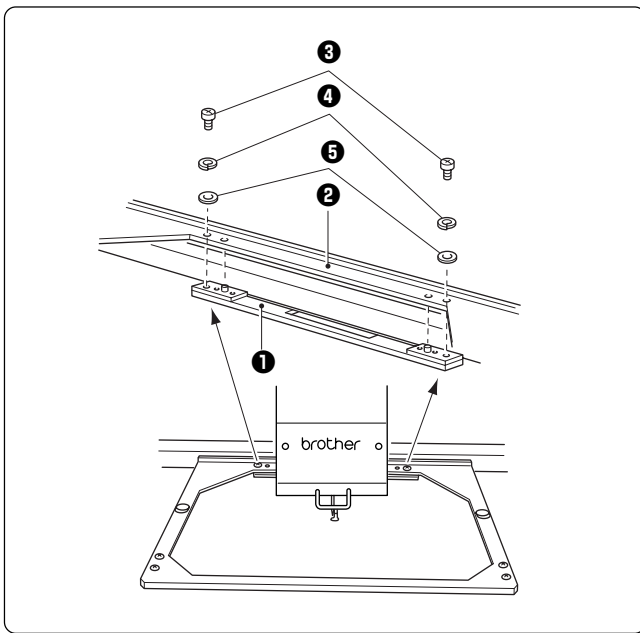

1. Turn off the machine power switch.
2. Pull X carriage **1** fully toward you. Loosen two screws **3**. Remove flat hoop frame (assembly) **2** with spring washers **4** and plane washers **5** from X carriage **1**.

Note) Save the two screws, spring washers, and plane washers removed in the above step. They will be used later.

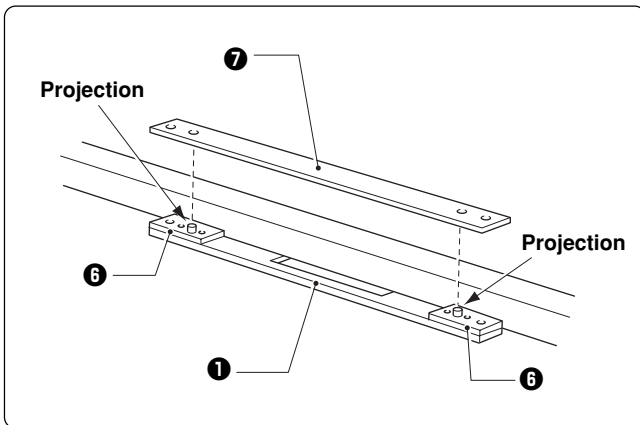

3. Fit spacer **7** to the projection of frame base plate assembly **6** mounted on X carriage **1**.

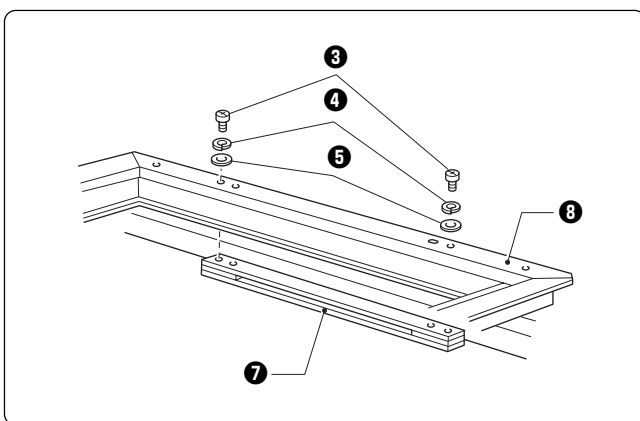

4. After attaching spacer **7**, attach sash frame **8** in the same manner and fix them using screws **3**, spring washers **4**, and plane washers **5** removed in step **2**.

Note) When attaching the sash frame, check that the side with felt affixed to the back faces the front.

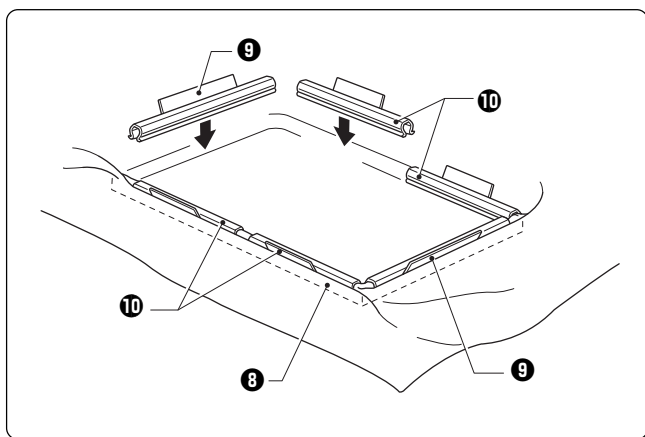

5. Put material over sash frame ⑧. Attach two clips 290 ⑨ to both vertical sides securely. Also attach two clips 220 ⑩ to both horizontal sides securely.

With a sash frame, the allowable embroidery area is 300 mm (vertical) x 450 mm (horizontal).

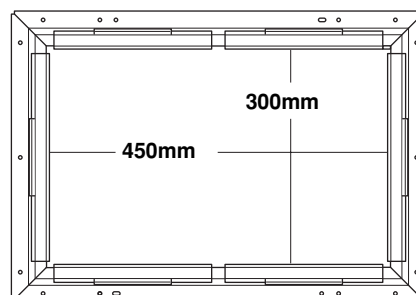

4-7 Adjustment of Thread Tension

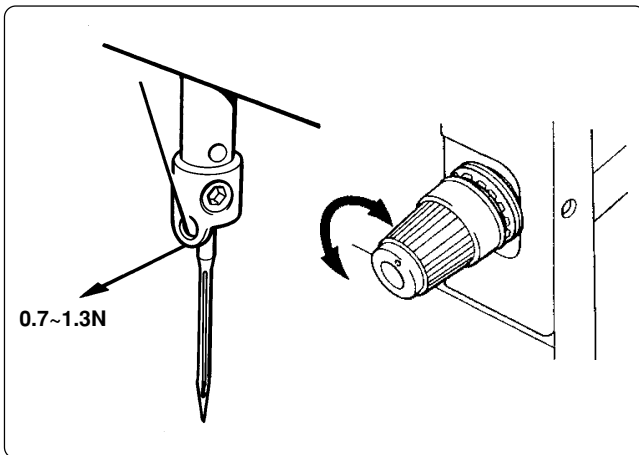

■ Adjustment of upper thread

If the needle thread tension is too high, turn the dial counterclockwise.

If the needle thread tension is too low, turn the dial clockwise.

Adjust upper thread tension to 0.7~1.3N when the thread is pulled at the needle bar thread guide.

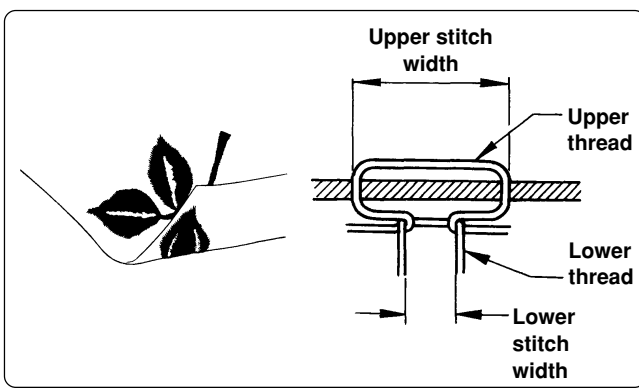

* Correct adjustment

Turn the upper thread tension dial so that the needle thread can be pulled to the back of the material and that the lower stitch width will be about 1/3 of the upper stitch width.

■ Adjustment of tension spring

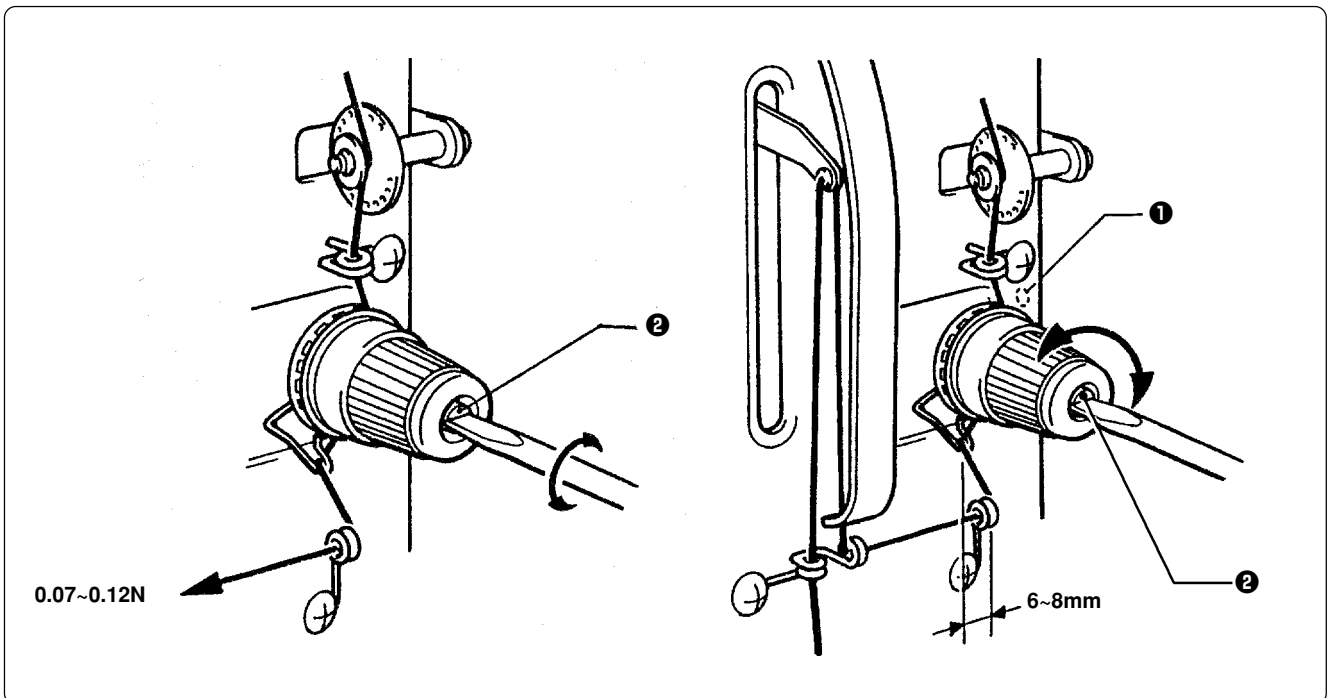

1. The tension spring should be adjusted to 6~8 mm in height and 0.07~0.12 N in force.

2. For adjusting the height, loosen the screw ❶ and turn the upper thread tension assembly.
3. For adjusting the tension spring force, insert a driver tip in the groove of the thread tension bar ❷ and turn it.

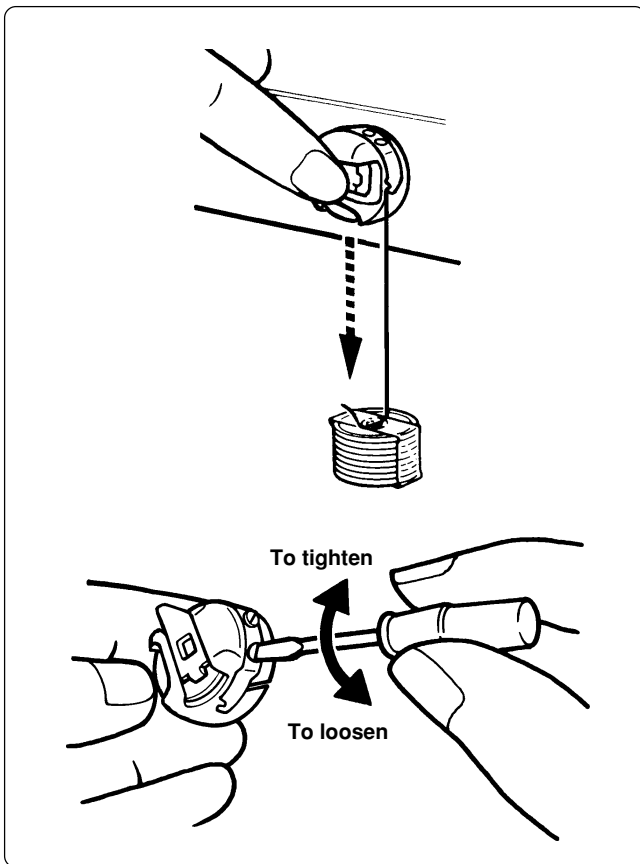

■ Lower thread tension

The standard tension of the lower thread is 0.2~0.3N.

This tension may vary depending on the used thread. In general, press the bobbin case to a smooth vertical surface and hang the designated number of coins. Turn the thread tension screw so that the lower thread will come out smoothly.



Chapter 2

Embroidering Procedures

After installation of machine start embroidering. This chapter explains about the operation panel on the machine as well as precautions for the actual embroidering process.

Functions of Operation Panel

Operation Panel

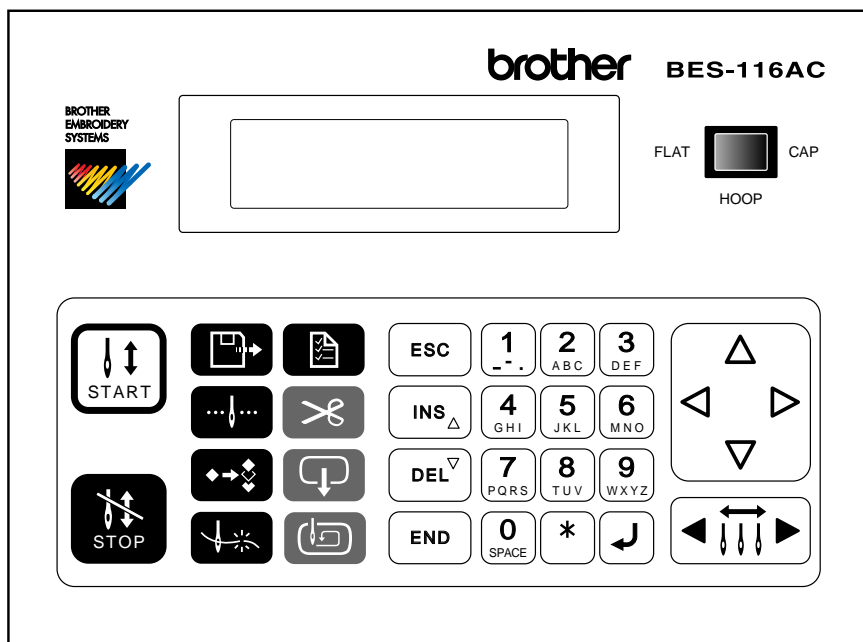

Starts embroidering.

Restarts after moving the carriage to embroidering start position by using the jog switch.

Restarts embroidering after a suspension.



Cancels errors during embroidering.

Suspends embroidering.



Selects sewing data. (→ "Chapter 3 Selection of Data and Embroidering" page 43)



Specifies a sequence of colors (sequence of needle changes) in sewing data.
(→ "Setting of Needle Bars" page 76)

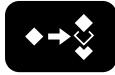

Edits sewing data. (→ "Chapter 4 Editing of Embroidering Data" page 61)



Sets the upper thread breakage sensor. (→ "Thread Breakage Sensor" page 78)



Machine motions can be set. (→ "Chapter 5 Setting" page 73)



Trims thread during suspension.



Moves the hoop to a preset hoop retract position. When this switch is pressed again, the hoop returns to the previous position.



Checks the embroidering area.

Moves the hoop automatically into the embroidering area when the embroidery position is out of the area.



Used for selecting data and setting functions.



Selects the flat or cap hoop. This selection should be done before turning the power ON to the machine. The setting will not be changed if the selection is done after turning the power OFF.

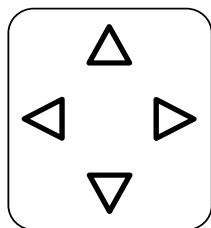

Moves the hoop.

Step-back or forward is available during suspension. (Use ◀▶ switches only.)

Changes the speed range during embroidering (Use ▲▼ switches only).

Carries out inching of the hoop when the switch is pressed in the inching mode.

Move the cursor for selecting sewing data and an icon.

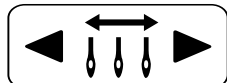

Change to the screen for selecting sewing data.

Operation panel

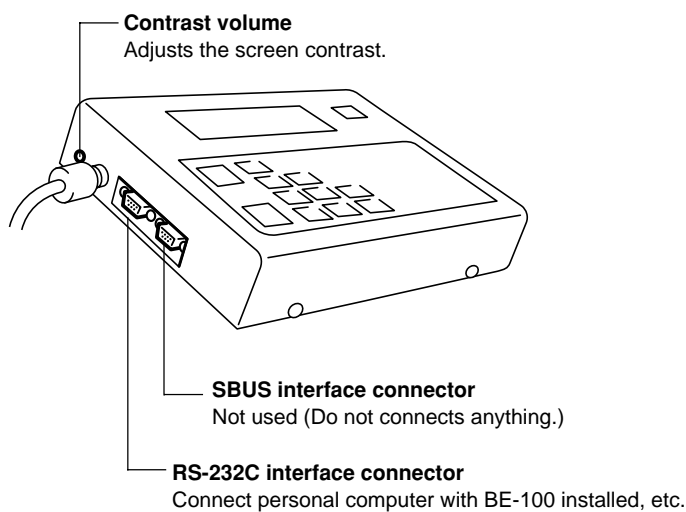

Shut-off switch unit

The operation panel is equipped with the shut-off switch unit, depending on the model.

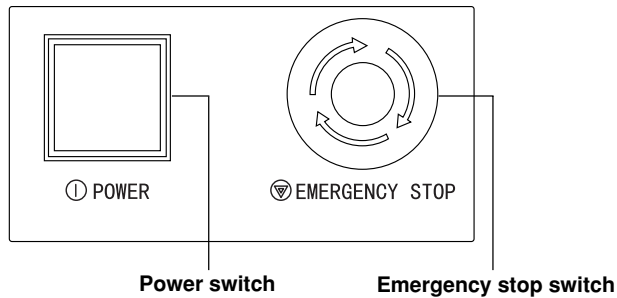

■ Power switch

Press this switch to turn on the machine. The switch is valid while the breaker switch is on and the emergency stop switch is reset.

■ Emergency stop switch

Press this switch to shut off the machine. Pressing the switch locks it while it is held down. To unlock the switch, turn it clockwise.

Stop switch unit

The operation panel is equipped with the stop switch unit, depending on the model.

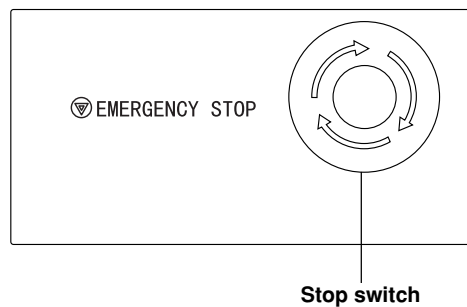

■ Stop switch

Press this switch to stop embroidering. When the switch is pressed, "Release stop SW to operate!" appears. Pressing the switch locks it while it is held down. To unlock the switch, turn it clockwise.

Flowchart of Preparation for Embroidering

Turn on the machine power. (→ page 41).



Retrieve the embroidery data (→ page 42).

"Chapter 3 Selection of Data and Embroidering" (→ page 43)



Edit the retrieved embroidery data.

"Chapter 4 Editing of Embroidering Data" (→ page 61)

Press  on the operation panel.



Press  on the operation panel.

Turn on the Machine Power

1. Turn on the power to the machine.

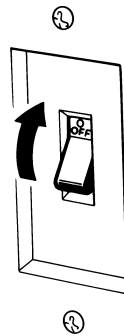

2. A message is displayed on the LCD as soon as the power is turned ON.



3. The alarm sounds three times. The needle bar and the presser foot move up. The hoop moves back to the zero point and the sewing screen is displayed.

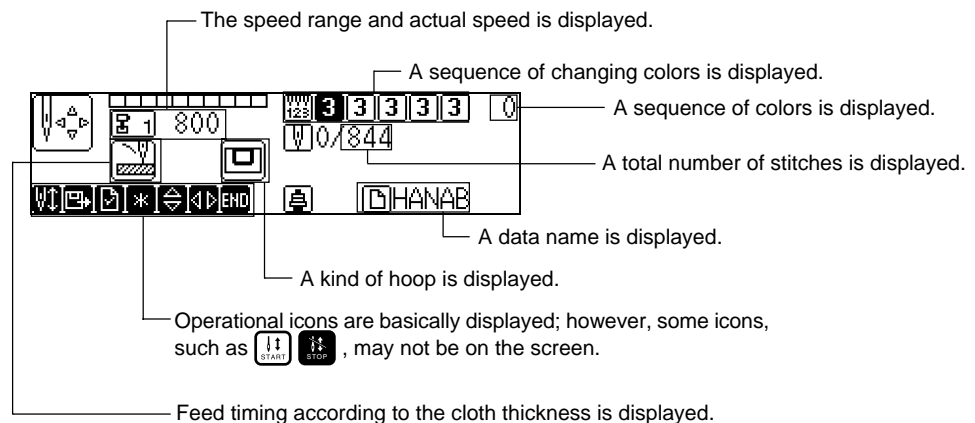

Retrieve the Embroidery Data

The description in this section is based on the method of reading data which is registered in the memory unit of the machine.

Refer to "Selection of Data" (→ Page 45) for details.

1. Press  switch.

Data saved in the machine is displayed.

2. Select a screen by pressing   keys, and select required data by pressing ten keys or    .

When using ten keys for data selection, input a numerical figure (1 ~ 9) which indicates each data name. Required embroidery data is selected and read.



3. Press  key.

Required embroidery data is selected and read.

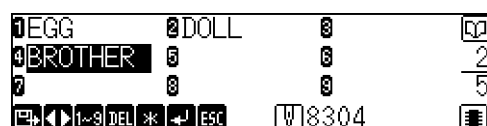

Selected embroidery data is read.

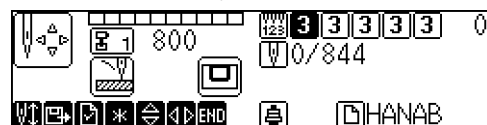

Start Embroidering

1. Press  to check the embroidering area.

2. Press  to start embroidering.



Sewing is started and the next screen is displayed.

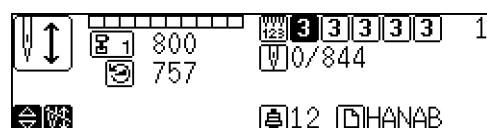



Chapter 3

Selection of Data and Embroidering

This Chapter describes how to select embroidery data in order to start embroidering.

What Can the Machine Do?



Selection of Embroidery Data



Registration of data from the floppy disk (→ Page 45)



Reading of data from the memory (→ Page 48)



Registration of data created by BE-100 (→ Page 49)

(These icons are displayed in the lower right of the screen.)



Modification of data name (→ Page 52)

Deletion of embroidery data (→ Page 50)

Embroidering Operation

Embroidering start (→ Page 56)

Embroidering feedhold (→ Page 57)

Embroidering cancel (→ Page 57)

Step forward/step back (→ Page 58)



Step forward (back) stitch by stitch



Step forward (back) by every 10 stitches



Step forward (back) by every 100 stitches



Step forward (back) until a next color change



Step forward (back) to the embroidering start point of a next pattern

B↔F Designate stitch nos
([] / ****)

Step forward (back) by a specified number of stitches (→ Page 58)

Selection of Data

Select data in order to start sewing.

- Data to use for actual embroidering is selected from data registered in the machine memory. A maximum of 45 kinds or 480,000 stitches of embroidery data can be registered in the machine memory; however, depending on the combination of embroidery data, the number of total stitches available may become less.
- When using data in a floppy disk or in BE-100, register it in the machine memory once before selection.
If there is no space in the machine memory, delete unnecessary data to make a space.

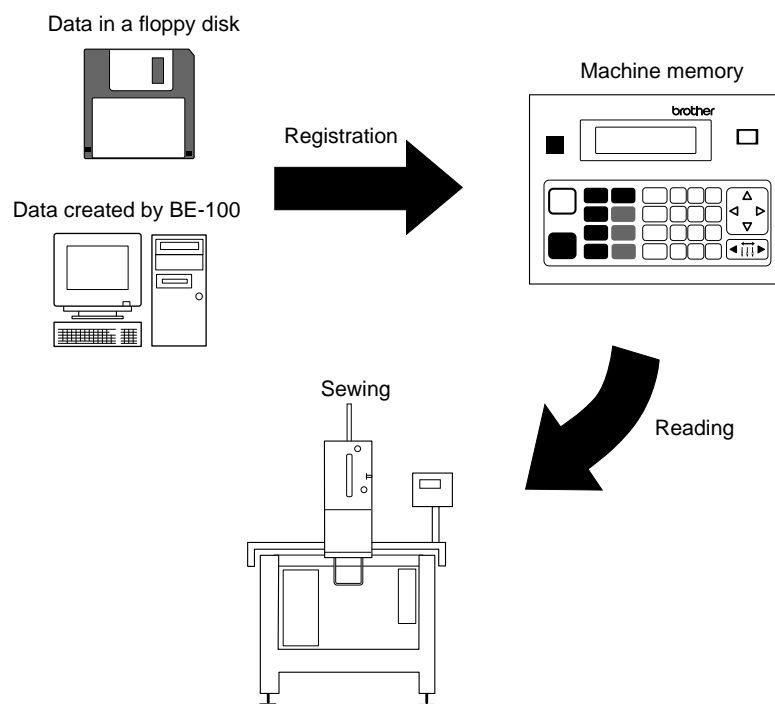

Registration of Embroidery Data from Floppy Disk

Register embroidery data from a floppy disk into the machine memory.



- Types of data to be registered are as shown below.

- DOS-formatted data

Data format	Extension	Icon
ECS	Data with a name of [xxxx.ECS]	
Tajima	Data with a name of [xxxx.DST]	
Barudan	Data with a name of [xxxx.DSB]	
Zanks (DSK)	Data with a name of [xxxx.DSZ]	
Data received from BE-100	Data with a name of [xxxx.STH]	

(These icons are displayed in the lower right of the screen.)

• Other data

Data format	Icon
Barudan FDR	
Barudan FMC	
Zanks ZSK	

(These icons are displayed in the lower right of the screen.)

Loading and Loading of Floppy Disk

1. When loading a floppy disk, set it straight with the labeled surface facing this side.

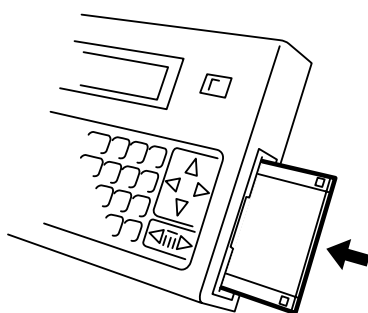

2. When unloading a floppy disk, press the eject switch.

3. When it comes out, pull it straight.

When the access lamp is ON, never press the eject switch. Otherwise, embroidery data in the floppy disk may be destroyed.

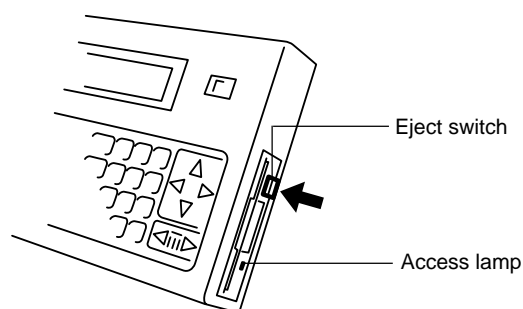

Registration of Sewing Data into Machine Memory

1. Load a floppy disk with sewing data.

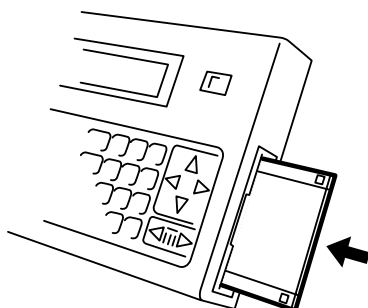

2. Press .

3. Select a screen for data registration by pressing  .

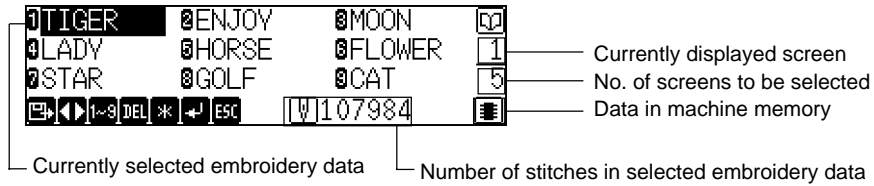

4. Select an area for registration, using ten keys or    , then press

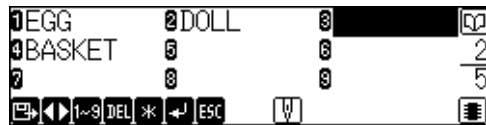

A space available is automatically selected.

Pressing  automatically locates the first space in the memory.

5. Data in the floppy disk is displayed. Press   to select a screen.

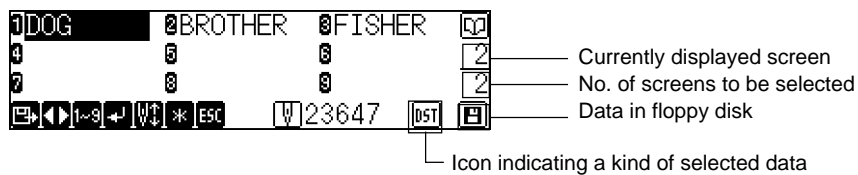

Pressing  displays a pattern name.



6. Select data to register by pressing ten keys or     then press .

Data is newly registered in the machine memory.



Select embroidery data and press . The selected data is automatically registered in the memory and the machine enters a standby status.

If registration is done without loading a floppy disk, the following screen is displayed after the step 4 is finished.

Load a floppy disk for data registration.

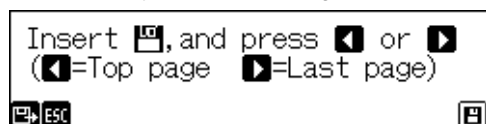

Reading from Memory

Data to use for sewing can be selected from the machine memory.

■ A maximum 45 kinds or 480,000 stitches of embroidery data can be registered in the memory.

1. Press .

Embroidery data registered in the memory is displayed.

2. Select a screen by pressing  .



3. Select embroidery data to read by pressing ten keys or    .

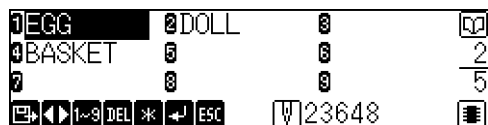

4. Press .

Embroidery data is selected and read.

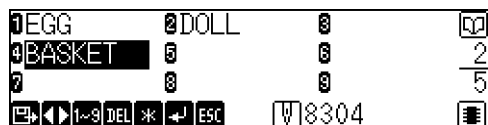

When a free space is specified in the memory, a screen for reading data from the floppy disk is displayed.

Refer to "Registration of Sewing Data into Machine Memory" (steps 5 and afterward on Page 47).

5. The initial screen is displayed.



Registration of Embroidery Data from BE-100

Connect the operation panel and the personal computer with BE-100 installed in order to register the embroidery data into the machine memory.

1. Connect the personal computer with BE-100 installed and the operation panel by means of the RS-232C cable.

Personal computer with BE-100 installed

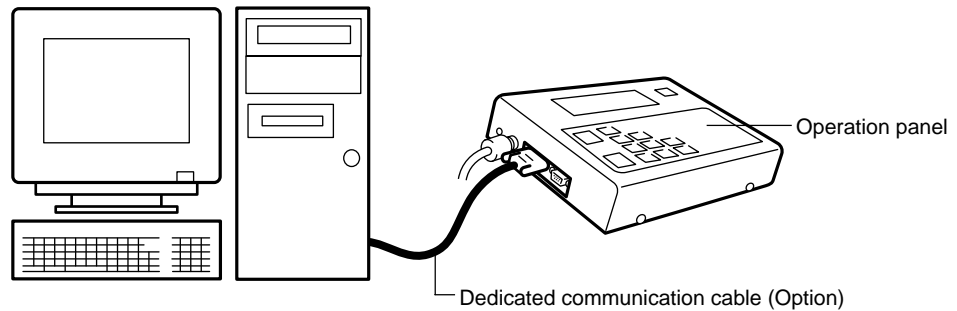

2. Press the .
3. Select the data registration screen by pressing the  .



4. Select an area for data registration by pressing ten keys or    , and then press the  key.

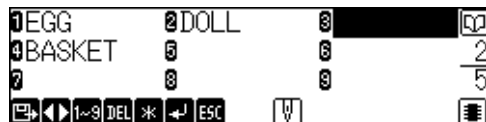

5. Press the .



When a floppy disk is set

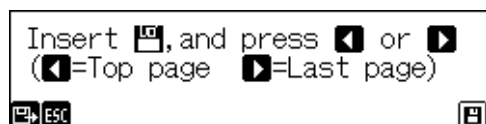

When no floppy disk is set

6. Press the ◀▶.

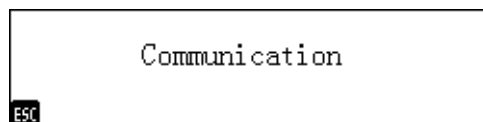
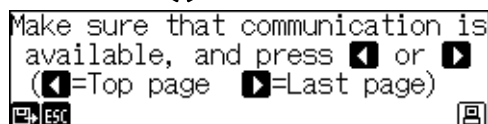

7. The BE-100 embroidery data is displayed. Press the ◀▶ and select a required screen.



8. Select embroidery data to register by pressing ten keys or ◀▶△▽, and then press the ↵ key.

The data is registered in the machine memory.



Deletion of Embroidery Data from Machine Memory

Embroidery data can be deleted from the machine memory.

1. Press [F4].

A list of registered data is displayed.

2. Select a screen by pressing ◀▶.



— Currently displayed screen
— No. of screens to be selected

3. Select embroidery data to delete by pressing ten keys or ◀▶△▽.



4. When  is pressed, the confirmation message is displayed.



5. When  key is pressed, selected embroidery data is deleted from the memory.

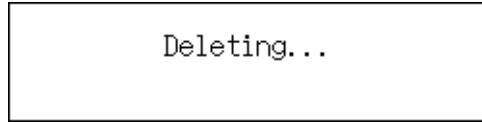

When deleting embroidery data in the machine memory entirely:

When deleting embroidery data registered in the machine memory entirely, turn ON the power to the machine while pressing . (Refer to “Clearing internal memory” on page 28.)

Modification of Embroidery Data Name

Name of embroidery data registered in the machine memory can be modified.

This example shows how to modify the data name "FLOWER" to "TEST003".

- A maximum number of characters to use for an embroidery data name is 8.
- The following kinds of characters can be used.
- It is impossible to input a ". " or space.

Alphabetical characters (A ~ Z) Numerical characters (0 ~ 9)

Use **0** through **9**. An input character changes depending on the number of times each is pressed as shown below.

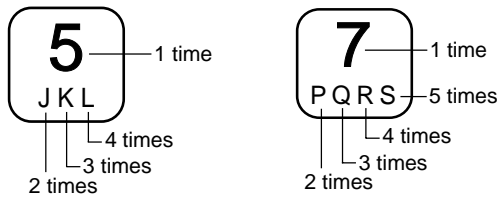

_ (underbar), - (hyphen)

Use **1**.

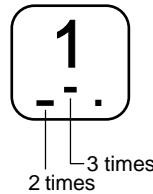

1. Press . Embroidery data saved in the memory is displayed.
2. A list of embroidery data is displayed. Select a screen by pressing .



3. Select embroidery data to modify the name by pressing ten keys or .
4. Press *****.



When selected data has a pattern name, the name is displayed. Press the ***** key once again.



5. Input a new data name by pressing ten keys.

When modifying embroidery data names entirely

6. Pressing **DEL** deletes currently reversed characters.

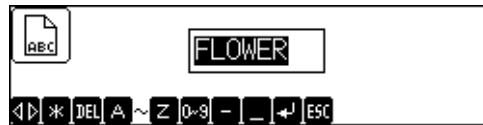

7. Press **8** twice.

"T" is input.



8. Press **3** three times.

"E" is input.



9. Press **7** five times.

"S" is input.



10. Press **8** twice.

"T" is input.



11. Press **0** once.

"0" is input.



12. Press **▷**.

When inputting the same character continuously, press the **▷** to move the cursor to the right.



13. Press **0** SPACE once.

"0" is input.



14. Press **3** DEF once.

"3" is input.



15. After inputting a data name, press **↵**.

A data name is modified by the above procedures.



When modifying only one character:

[FLNWER] can be modified to [FLOWER] in the following procedures.

6. Press **◁**.



7. Press **▷** twice and display "N" reversely.



8. Press **DEL** ▽.

"N" is deleted.



9. Press **6** MNO four times.

"O" is input.

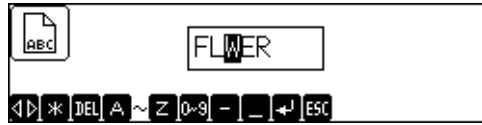

10. Press **↵**.

A data name is modified by the above procedures.

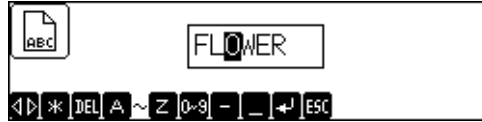

Sewing Operation

Before Starting Sewing

Select a hoop to set on the machine.

■ The following operation should be done before turning the power ON to the machine. Otherwise, it will damage the hoop.

1. **Select either the flat hoop or cap hoop, using FLAT or CAP switch on the operation panel.**

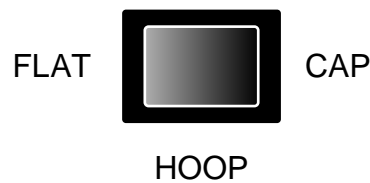

When a flat or tabular hoop, or a sash frame is set on the machine, select [FLAT].
 When a cap hoop is set, select [CAP].



2. **Specify an embroidery hoop set on the machine, referring to "Embroidery Hoop" (→ Page 81).**

Starting Sewing Operation

■ For details of specifying a sewing start position, refer to "Registration of Sewing Start Position" (→ Page 88).

■ When  is pressed while the message "Area over" is indicated on the screen, a dialog box is displayed for confirming whether or not to start sewing forcibly. Pressing  starts sewing; however, depending on the start position, an interference with the frame may occur. Exercise added care when doing so.

1. **Check that sewing data has been selected, then press .**
 Sewing is started.

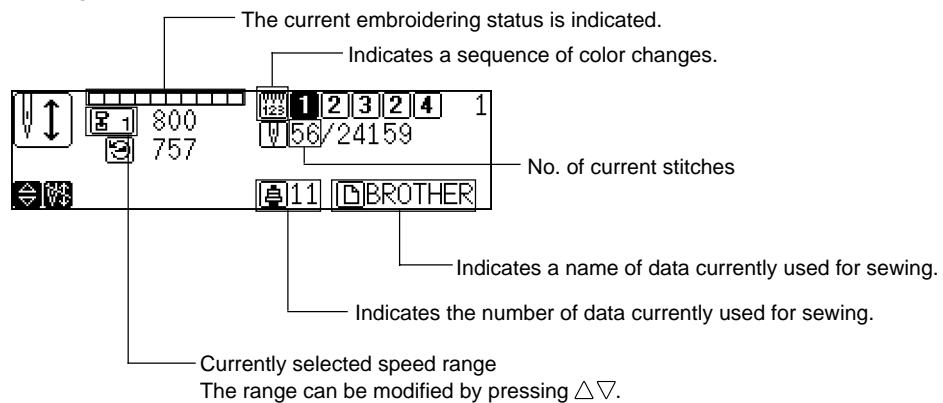

Feedhold and Cancellation of Sewing

Feedhold

1. Press  .

Sewing is interrupted.

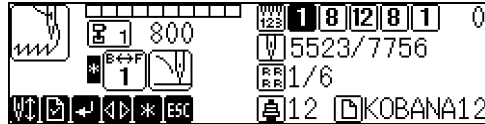

Cancellation

1. Press  while sewing is interrupted.

When repetition of patterns is set, a pattern which is currently being sewn is canceled. When canceling all patterns, press  once again.

2. A message for confirmation is displayed. When canceling sewing, press

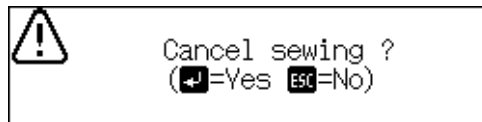

Step Forward and Step-Back

Stitches can be advanced (step forward) or retracted (step-back) without sewing.

Step Forward/Step-Back Mode





1. Press  when selecting either mode before starting sewing and press



when selecting a mode during sewing.

Setting Amount or Timing of Step Forward/Step-Back

A step forward/step-back amount or timing can be selected as described below.

	For stepping forward (back) stitch by stitch
	For stepping forward (back) by 10 stitches
	For stepping forward (back) by 100 stitches
	For stepping forward (back) up to the next (previous) color change
	For stepping forward up to the sewing start point of a next pattern if repetition of patterns is set.
B<->F Designate stitch nos (<input type="text"/> / ****)	Specify the number of stitches for stepping forward (back).

1. Select a required item as described above by pressing .

When the number of stitches is specified, the needle steps forward (back) to an input position:

1. Press the  five times.
2. Input the number of stitches to move by pressing ten keys.

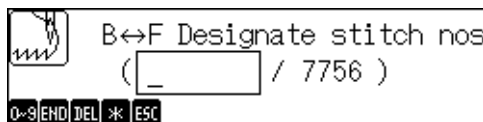

3. Press the .

The needle steps forward (back) as specified.

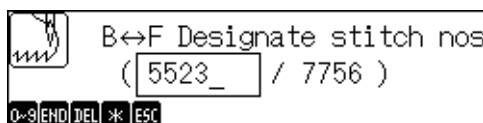

4. The embroidery head advances (retracts) by a specified number of stitches.

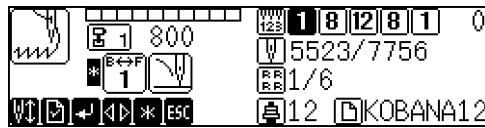

For Step Forward (Back)

1. Press .
Stitches steps forward (back) by a specified amount.

Resuming Sewing

1. Press .
Sewing is started.

Writing the embroidering data

The embroidering data stored in the memory of the machine is written to the floppy disk.

■ The format of the data to be written is brother ESC or TAJIMA TFD.

1. Press the  button.

The embroidering data stored in the memory is displayed.

2. The list of the embroidering data is displayed. Select the screen by pressing  .



3. Select the embroidering data to be written with numeric keys or    .



4. Press the  button.

5. Designate the thread trimming feed number with  .

It cannot be designated when the ECS data format is selected.

Use numeric keys, , or the  button to change the file name.

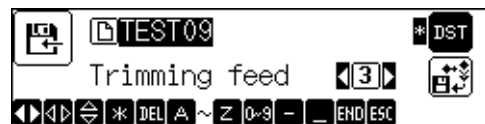



In any data format other than the ECS format



In the ECS data format

6. Highlight the icon of the data format with   and designate the format of the data to be written with .

7. Highlight the edit value validating or invalidating icon with   and designate validating or invalidating of the edit value.

8. Set the formatted floppy disk.

9. Press the  button.

The selected embroidering data is stored on the floppy disk.

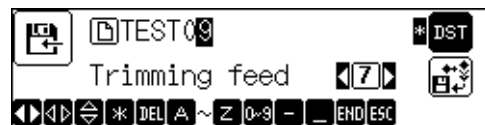



Chapter 4

























Editing of Embroidering Data

Pressing  on the operation panel after reading embroidering data displays the embroidering data editing screen. Simple operation by using embroidering data is available on this screen.

What Can the Machine Do?

Editing

- Enlargement/reduction is executed ahead of rotation. When an embroidery pattern is so set to be rotated by 90° and then enlarged by 2 times in the X-axis direction, the X-axis enlargement is executed first and rotation by 90° is executed afterwards. Therefore, a pattern is enlarged by 2 times at the sewing point.

		Rotation of embroidery pattern (→ Page 63)
		Enlargement/reduction of embroidery pattern in the X-axis direction (→ Page 64)
		Enlargement/reduction of embroidery pattern in the Y-axis direction (→ Page 64)
		Mirror pattern (→ Page 66)
		Right/left mirror pattern
		Up/down mirror pattern
		Zero point symmetric mirror pattern
		No. of repetitions in the horizontal direction (lines) (→ Page 68)
		No. of repetitions in the vertical direction (rows) (→ Page 68)
		Distance in the horizontal direction between two outer hoop centers (→ Page 68)
		
		Distance in the vertical direction between two outer hoop centers (→ Page 68)
		
		Direction of repetitions (→ Page 68)
		Horizontal direction from upper left to lower right
		Vertical direction from upper right to lower left
		Horizontal direction from lower right to upper left
		Vertical direction from lower left to upper right
		Horizontal direction from upper right to lower left
		Vertical direction from upper left to lower right
		Horizontal direction from lower left to upper right
		Vertical direction from lower right to upper left
		0 stitch deletion (→ Page 70) Thread trimming feed number (→ Page 71) Swing width correction (→ Page 71)

Rotation

A pattern can be rotated.

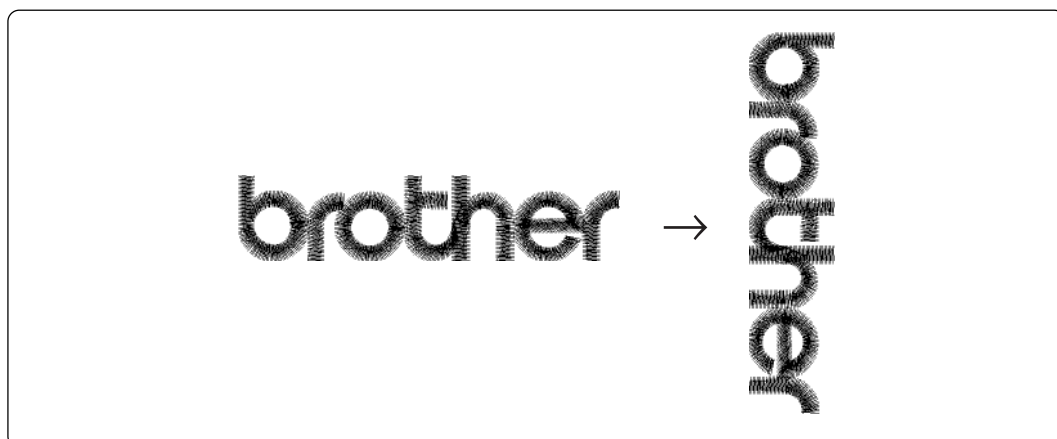

- A maximum range of rotation is 1 ~ 359 degrees.
- The rotating direction is counterclockwise.
- Rotating angle can be set in either of the following.

By using ◀▶

Angle can be specified in increments of 90°. Setting of 90°, 180° or 270° is available.

By using ten keys

Angle can be specified in increments of one degree.

1. Read sewing data.
2. Press .
3. Press ◀▶ to select an angle or use ten keys to specify an angle.

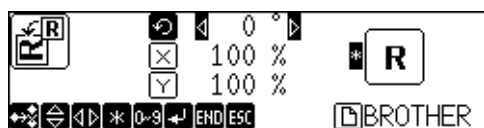

4. Press .

The initial screen is displayed again.

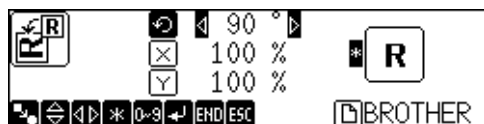

Enlargement and Reduction

A pattern can be enlarged or reduced.

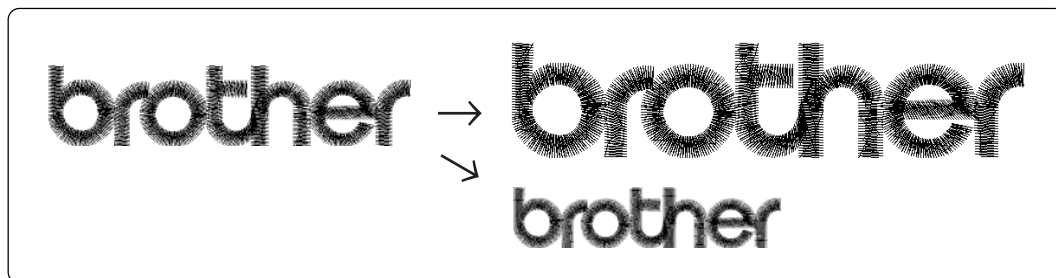

- The enlargement and reduction ratio is 50 ~ 200%.
- The number of stitches does not change even by enlargement or reduction of a pattern. However, stitches may become too rough or close if enlargement or reduction is excessive.
- There are the following two types of enlargement/reduction.
 - Enlargement/reduction at the same ratio in both the X and Y directions
 - Enlargement/reduction at different ratios in the X and Y directions

1. Read sewing data.

2. Press .

Enlargement/reduction at the same ratio in the X/Y directions

3. Press .

  are reversed in black.

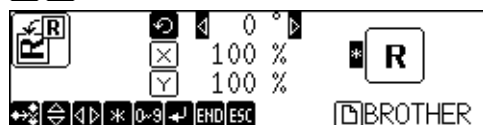

4. Input enlargement/reduction ratio by pressing ten keys.

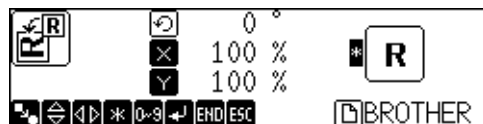

5. Press .

The initial screen is displayed again.

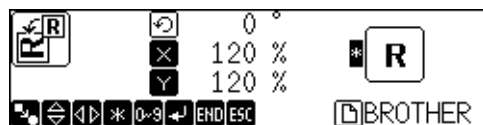

Enlargement/reduction at different ratios in the X/Y directions

3. Press ∇ twice.

\boxtimes is reversed in black.

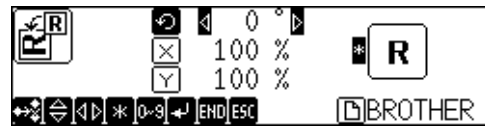

4. Input enlargement/reduction ratio in the X direction by pressing ten keys.

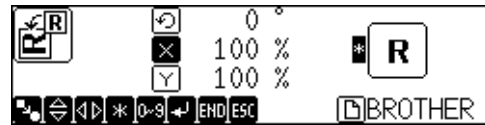

5. Press ∇ .

\boxdot is reversed in black.

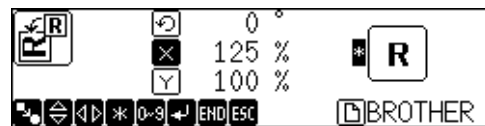

6. Input enlargement/reduction ratio in the Y direction by pressing ten keys.

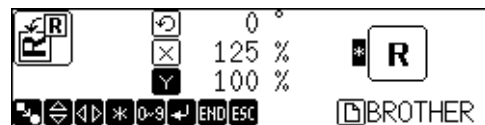

7. Press **END**.

The initial screen is displayed again.

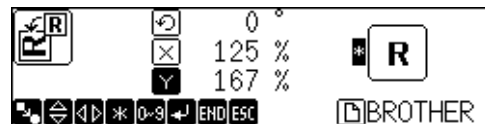

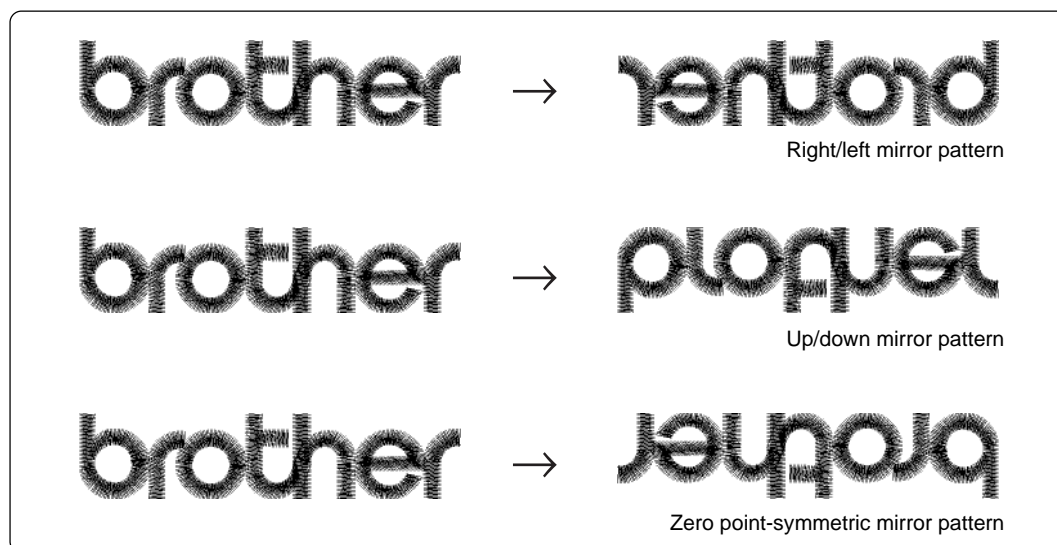

Mirror

A pattern can be reversed as if it is reflected in the mirror.



■ Up/down mirror pattern → Right/left mirror pattern → Zero point-symmetric mirror pattern.

	Right/left mirror pattern	The pattern is reversed in the right/left direction on the basis of the embroidering start point.
	Up/down mirror pattern	The pattern is reversed in the up/down direction on the basis of the embroidering start point.
	Zero point-symmetric mirror pattern	The pattern is reversed on the basis of the embroidering start point.

1. Sewing data is read.

2. Press  .

Right/Left Mirror Pattern

3. Keep pressing ***** until  is displayed.

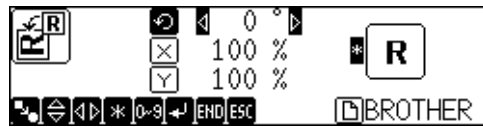

4. Press **END**.

The initial screen is displayed again.

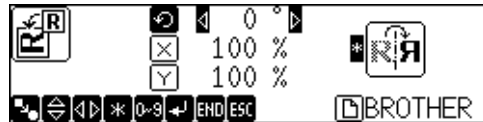

Up/Down Mirror Pattern

3. Keep pressing ***** until  is displayed.

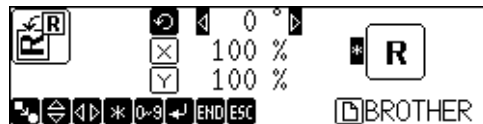

4. Press **END**.

The initial screen is displayed again.

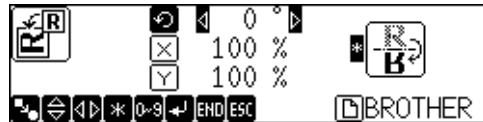

Zero Point-Symmetric Mirror Pattern

3. Keep pressing ***** until  is displayed.

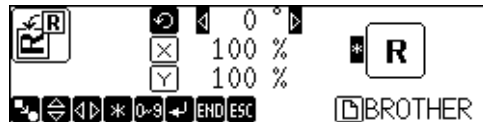

4. Press **END**.

The initial screen is displayed again.

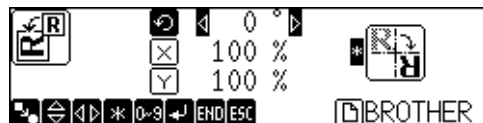

Repetition

A pattern is repeatedly copied as many times as specified.

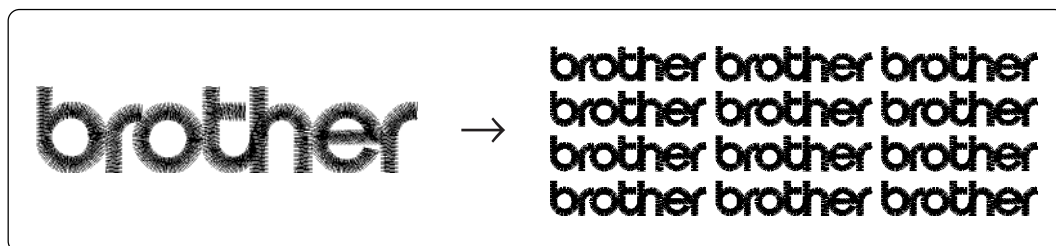

- The number of repetitions is 1 ~ 99 in both the vertical (row) and horizontal (line) directions.
- There are the following eight directions of repetitions.

	Horizontal direction from upper left to lower right
	Vertical direction from upper right to lower left
	Horizontal direction from lower right to upper left
	Vertical direction from lower right to upper left
	Vertical direction from lower left to upper right
	Horizontal direction from upper right to lower left
	Vertical direction from upper left to lower right
	Horizontal direction from lower left to upper right

- There are the following two types of intervals between repetitions.

	By setting a distance between the outer hoops of each pattern
	By setting a distance between the centers of each pattern

1. Read sewing data.
2. Press twice.
3. Input the number of repetitions in the vertical and horizontal directions, by pressing ten keys.

The vertical and horizontal directions are changed over by pressing $\Delta \nabla$.

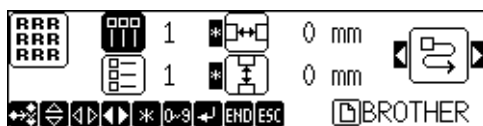

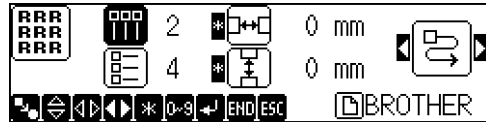
4. Press \triangleright .

5. Input intervals between repetitions by pressing ten keys.

The vertical and horizontal directions are changed over by pressing \triangle / ∇ .

Press $*$ for setting a distance between the centers of each pattern.

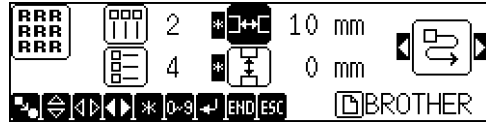

For setting a distance between the outer hoops of each pattern

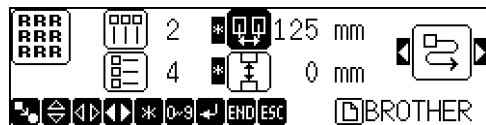

For setting a distance between the centers of each pattern

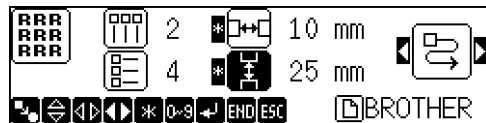
6. Select the direction of repetitions by pressing \blacktriangleleft / \blacktriangleright .7. Press END .

The initial screen is displayed again.



Other Editing

Setting of other functions related to editing is available.

- The following types of setting is available.

0 stitch deletion	For deleting stitches at the same point without stepping forward or back. This function is previously set to <input checked="" type="checkbox"/> (for not deleting 0stitch)upon shipment. <input type="checkbox"/> For deleting 0 stitch <input checked="" type="checkbox"/> For not deleting 0 stitch
Thread trimming feed number	For setting the number of feeds for thread trimming This function is previously set to <input checked="" type="checkbox"/> (ECS data) or <input type="checkbox"/> (Except ECS data)upon shipment. <input type="checkbox"/> 1 ~ <input type="checkbox"/> 8 For thread trimming at the number of feeds indicated on the icon <input checked="" type="checkbox"/> For not thread trimming by feeding
Swing width correction	For setting the needle swing width correction amount The correction amount can be set in increments of 0.1mm. The setting range is -0.5 ~ 2.0mm in both the X and Y directions. (The setting range is displayed as "-5 ~ 20" on the screen.) This function is previously set to 0(no swing width correction)upon shipment.



1. Read sewing data.
2. Press  three times.

0 Stitch Deletion

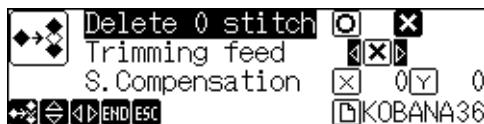
3. Select this function by pressing  .



4. Press  after setting is finished.

Press   when setting continuously.

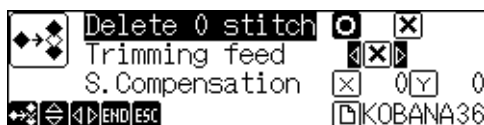

Thread Trimming Feed Number

3. Select this function by pressing \triangle / ∇ .

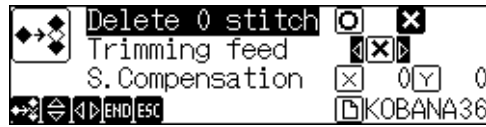

4. Select the number of feeds by pressing \triangleleft / \triangleright .

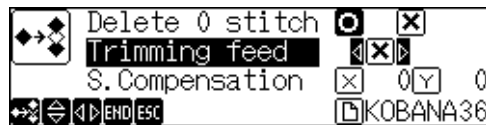

5. Press **END** after setting is finished.

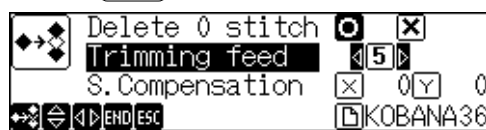

Sewing Width Correction

Correction values within -5 ~ 20 can be input. However, excessively large values may result in distortion of a pattern.

3. Select this function by pressing \triangle / ∇ .

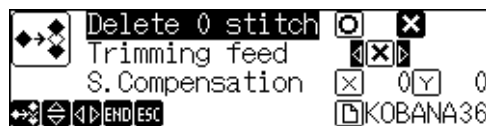

4. Select a correction amount in the X direction by pressing \triangleleft / \triangleright .

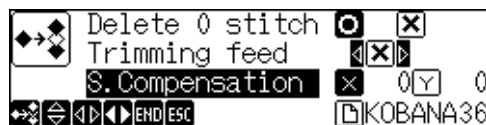

5. Reverse **Y** by pressing \triangleright .

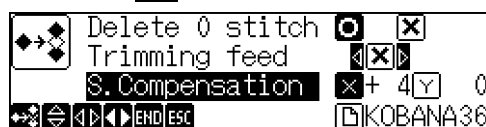

6. Input a correction amount in the Y direction by pressing \triangleleft / \triangleright .

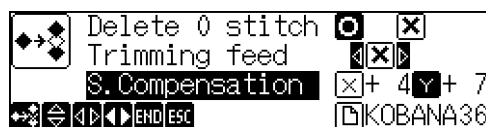

7. Press **END** after setting is finished.

Press Δ / ∇ when setting continuously.

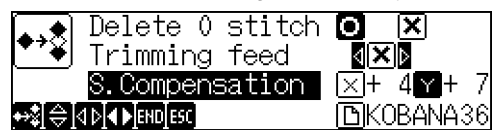



Chapter 5 Setting

This Chapter describes how to set a sewing speed, correct trouble including thread breakage and others related to machine motions.

What Can the Machine Do?

Setting of Needle Bars



Needle bars allocated in the sequence of embroidering (→ Page 76)

Setting of Thread Breakage Sensor



Thread breakage sensor ON/OFF (→ Page 78)



Thread breakage sensitivity (→ Page 78)



Number of stitches in automatic step back (→ Page 79)



Display of total stitch number in automatic step back



Lower thread counter counts (→ Page 80)



Stitch counter indication (→ Page 80)

Setting of Machine



Selection of embroidery hoop (→ Page 81)



Speed range (→ Page 82)



Speed in speed range (→ Page 83)



Thread trimming length (→ Page 85)



Thread removal feed length (→ Page 85)



Inching ON/OFF (→ Page 86)



Sewing area (→ Page 87)



Resetting of thread breakage error (→ Page 84)

Setting of Environment



Return to start point after embroidering end (→ Page 90)



Method of reflecting modified machine speed (→ Page 90)



Method of checking the embroidery area (→ Page 91)



Feed rate adjustment (→ Page 92)



Data transfer speed (→ Page 92)

Display language (→ Page 93)

Alarm sound (→ Page 94)

Motive speed (→ page 95)

Small-pitch deletion (→ Page 96)

XY Feed Power (→ Page 96)

Setting of Boring



Boring mode ON/OFF (→ page 98)



Data shift ON/OFF (→ page 99)

Setting of Lock Stitch



Lock stitch ON/OFF (sewing start position) (→ page 99)



Lock stitch ON/OFF (sewing send position) (→ page 100)



Lock stitch ON/OFF (sewing start position after thread trimming) (→ page 101)

Setting of speed limit in a small pitch

Speed limit in a short pitch (→ page 102)

Display of Information



Display of pattern information (→ Page 107)



Features of machine (→ Page 108)



Version information (→ Page 109)



Feed timing (→ Page 103)



Automatic input setting (→ Page 104)

Hoop Retract Point



Hoop retract point (→ Page 88)



Automatic hoop retract ON/OFF (→ Page 89)

Hoop Movement

Registration of embroidering start point (→ Page 88)

Movement to registered sewing start point (→ Page 89)

Setting of Needle Bars

Needle bars allocated in the sequence of sewing can be modified.

- BES-116AC is not equipped with needle bar change mechanism. However, the following procedure is available to input reference information about color changes.
- Either feedhold or hoop retract can be inserted.

1. Press .
2. Select a sewing sequence to modify by pressing  .

The current embroidering sequence is selected while embroidering is interrupted.

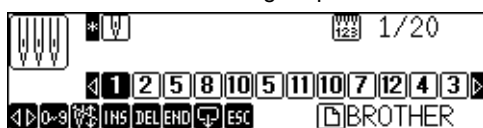

Press  for modifying all sequences at one time.



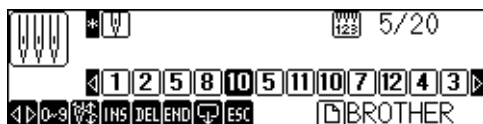

3. Input the number of a needle bar by pressing ten keys.

When inputting a numerical figure exceeding 10, press the  first.



Insertion of Feedhold

Press  and reverse the display on the right of a point to insert a feedhold, then press .

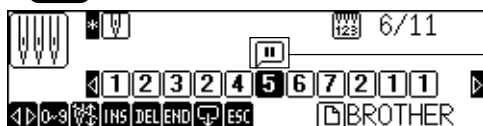

A feedhold mark is displayed.

4. Press .

Modified setting is saved and the previous screen is displayed again.



Insertion of Hoop Retract

1. Press **▶** to highlight the position right next to the position to insert the hoop retract and press **⏏**.

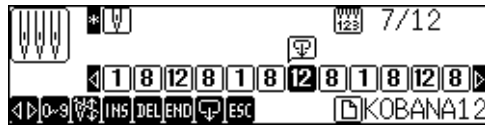

2. Press the **END** button.

The changed setting is stored and the previous screen is displayed.

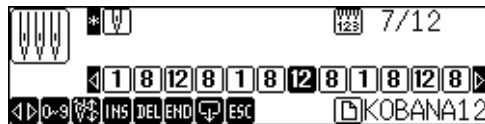

Thread Breakage Sensor

Validity or invalidity and sensitivity of the thread breakage sensor can be set.

Setting of sensor validity/invalidity

■ This function is previously set to valid upon shipment.

1. Press .
2. Activate or deactivate the thread breakage sensor by pressing .

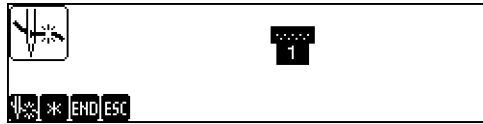

Valid

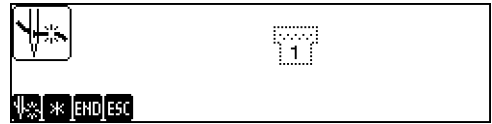



Invalid

3. Press .
- Modified setting is saved and the initial screen or halt screen is displayed again.

Thread Breakage Sensitivity

Sensitivity of the thread breakage sensor can be set.

- The sensitivity can be set within the range of 1 ~ 100. Sensitivity increases as the figure decreases.
- This function is previously set to 10 upon shipments.

1. Press  twice.
2. Select the needle bar for which the sensitivity is modified by pressing  .

The number of needle bars changes in the sequence of :
 ALL (all needle bars) → 1 → 2 → ... 9 or 12 (max.) → ALL → ...



3. Select  by pressing  .

4. Input sensitivity of the thread breakage sensor.



5. Press .
- Modified setting is saved and the previous screen is displayed again.

Automatic Step-Back

The number of stitches to step back automatically in case of a thread breakage can be set.

- Setting can be done within the range of 0 ~ 10 stitches.
- This function is previously set to 0 stitches upon shipments.

1. Press  twice.

2. Select  by pressing  .



3. Input the number of stitches to step back automatically by pressing ten keys.

Pressing  sets whether to execute an extra step-back by a sensitivity amount of the thread breakage sensor in the automatic step-back mode.



Total number of stitches to step back in the automatic step-back mode

When stepping back by a sensitivity amount of the thread breakage sensor



When stepping back by preset number of stitches

4. Press .

Modified setting is saved and the previous screen is displayed again.

Setting of Lower Thread Counter/Stitch Counter

- The lower thread counter reduces the indication each time one pattern is finished. After the reduction is finished, an error message can be displayed.
- The stitch counter increases the indication stitch by stitch.
- The lower thread counter can be validated or invalidated by pressing .
- The stitch counter can be cleared to zero by pressing .

1. Press three times.
2. Input the number of counts of the lower thread counter by pressing ten keys.



3. Press .
- Modified setting is saved and the initial screen or halt screen is displayed again.







Setting of Machine

Machine motions can be set.

Embroidery Hoop

Specify a type of an embroidery hoop set on the machine.

- A type of a hoop can be selected when a cap hoop or an air clamp hoop is selected by a switch on the operation panel.

When a cap hoop is selected		Semi-wide cap frame
		Wide cap frame
		Baseball cap frame
When an air clamp hoop is selected		L hoop
		M hoop
		S hoop
		VL hoop

- An air clamp hoop is available as an option. For the description of usage, refer to the accompanying instruction manual.

1. Press .

2. Select  by pressing  .

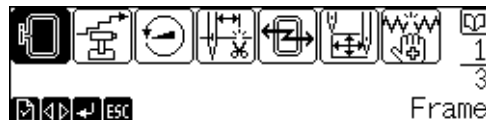

3. Press .

4. Select a type of a hoop by pressing  .

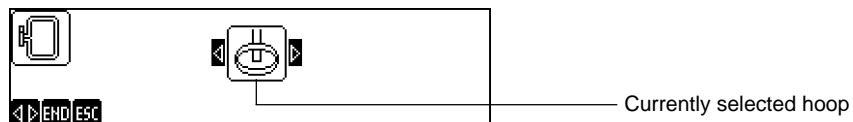

5. Press .

Modified setting is saved and the previous screen is displayed again.



Speed Range

A range of speed for each needle bar can be set.

- BES-116AC is not equipped with needle bar change mechanism. When setting thread color in a sequence, a speed range can be specified for each color.
- The speed range can be set within the range of 1 ~ 6.

1. Press .

2. Select  by pressing  .

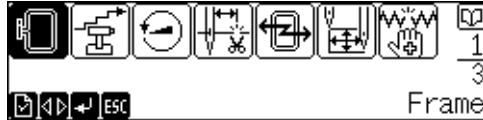

3. Press .

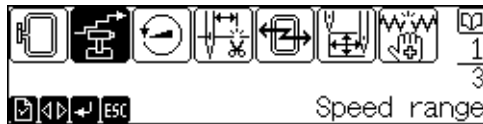

4. Select a needle bar by pressing  .

When setting the same speed range for all needle bars, press .



When modifying the speed range for one needle bar

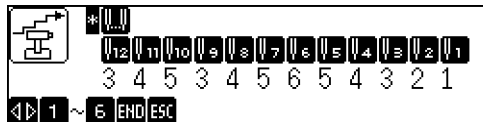

When modifying the speed range for all needle bars

5. Input a required speed range by pressing ten keys.

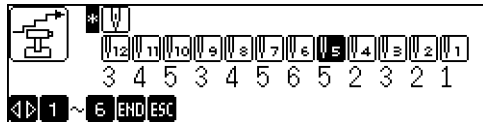

6. After modification is finished, press .

Modified setting is saved and the previous screen is displayed again.

Speed of Each Speed Range

Maximum speed of each range can be set.

- Speed can be input in increments of 10rpm.
- The upper limit of a speed to be set varies depending on a selected hoop.

1. Press .

2. Select  by pressing  .



3. Press .



4. Select a speed range to modify by pressing  .

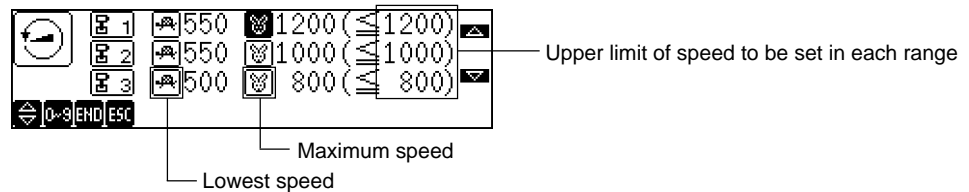

5. Input a required speed by pressing ten keys.



6. After modification is finished, press .





Modified setting is saved and the previous screen is displayed again.



Setting of Mending

Details of mending can be set in case of a thread breakage.

■ Contents of each setting item are as described below.

Item	Contents
	For setting whether to reset a thread breakage error automatically This function is previously set to  (Manual) upon shipments.
	For resetting an error automatically
	For resetting an error manually

1. Press  .

2. Select  by pressing   .

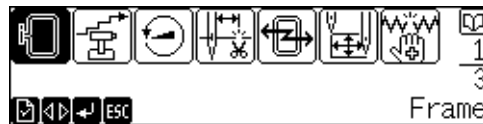

3. Press  .



4. Press  for modifying a resetting method.



5. Press  .

Modified setting is saved and the initial screen is displayed again.

Thread Trimming Length

Length of thread to leave on the needle bar after thread trimming can be set for each needle bar.

■ Thread trimming length can be set within the range of 1 ~ 6.

■ This function is previously set to 4 upon shipments.

1. Press  .

2. Select  by pressing $\triangleleft \triangleright$.

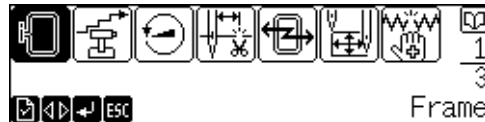

3. Press .



4. Select a needle bar to modify by pressing $\triangleleft \triangleright$.

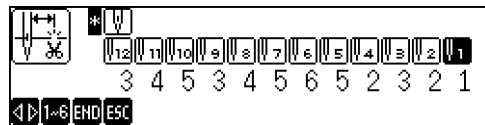

Press  for setting the same speed range for all needle bars.

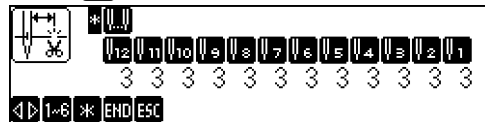

5. Input thread length by pressing ten keys.

Thread length can be input within the range of 1 ~ 6. Length decreases as the figure decreases.

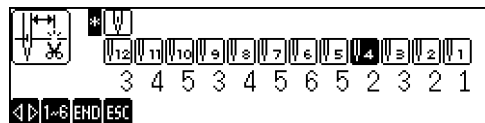

6. After setting is finished with all needle bars, press .

Modified setting is saved and the previous screen is displayed again.

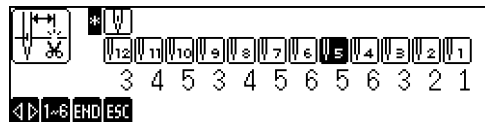

Thread Withdrawal Feed Length

Thread withdrawal length can be set before thread trimming.

- The input range is 0 ~ 100mm.
- This function is previously set to 15mm upon shipments.

1. Press .

2. Select  by pressing $\triangleleft \triangleright$.



3. Press .



4. Input thread withdrawal length by pressing ten keys.



5. Press .

Modified setting is saved and the previous screen is displayed again.

Inching

Whether to select the inching mode for thread trimming can be set.

■ This function is previously set to selected upon shipments.

1. Press .

2. Select  by pressing  .



3. Press .



4. Set whether to select the inching mode by pressing .



5. Press .

Modified setting is saved and the previous screen is displayed again.

Sewing Area

An allowable area for sewing can be set.

- A maximum sewing area using a flat hoop is as shown below.

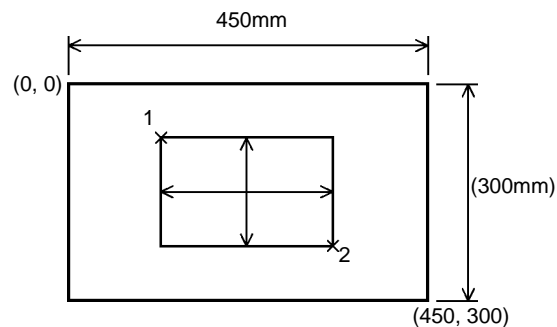

1. Press .

2. Select  by pressing  .



3. Press .

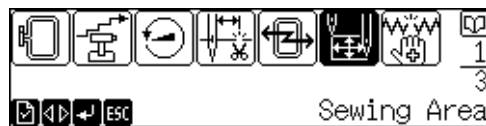

4. Specify coordinates of the upper left of the sewing area. Move the hoop by pressing    .

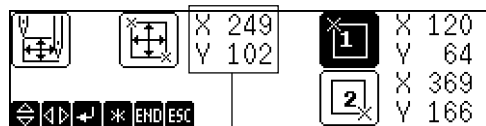

Indicates a currently set embroidery area

5. Press .

Pressing  set a maximum area designated for a currently set hoop.



6. Specify coordinates of the lower right of the sewing area. Move the hoop by pressing    .

7. Press .

Pressing  restores a status before modification of setting.

Registration of Sewing Start Position

Register a position to start sewing.

- When returning to a registered sewing start position, hold down  and press .

1. Press the  key.

The hoop coordinates are displayed.



2. Shift the hoop to a position to start sewing by pressing the    .



3. Press .

4. Press the  key.

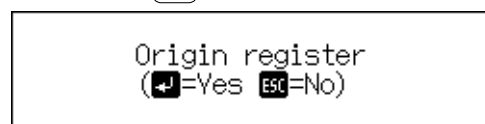

Hoop Retract Point

The hoop basic point (retract point) can be set when sewing is interrupted.

- When restarting sewing after the hoop is retracted during an interrupt, press .

1. Press .

2. Move the hoop by pressing    .

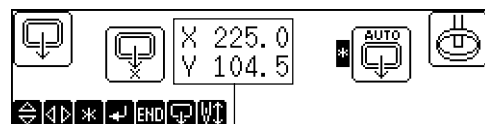

Current hoop coordinates

3. Press .

Modified setting is saved and the initial screen or halt screen is displayed again.
The hoop returns to the initial point.

Cancellation of Setting

1. Press  once again.

Modified setting is canceled and the initial screen or halt screen is displayed again. The hoop returns to the initial point.

Hoop Automatic Retract

Set whether to move the hoop automatically to the retract point at the end of sewing.

■ This function is previously set to no hoop automatic retract upon shipments.

1. Press .

2. Select whether to retract the hoop automatically by pressing .

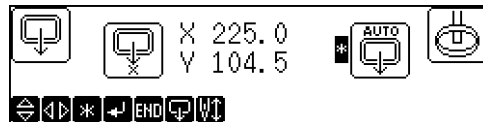

For automatically retracting the hoop

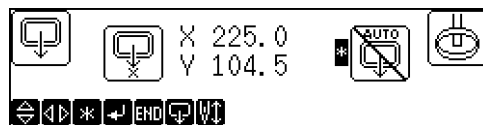

For not retracting the hoop automatically

3. Press .

Modified setting is saved and the initial screen or halt screen is displayed again.

Movement to Registered Sewing Start Point

This operation should be done before starting sewing.

1. Hold down  and press .

2. The hoop moves and the zero point is detected. Then the hoop moves to a registered start point.

Moving frame



Detecting home position...



Return to origin point

3. The initial screen is displayed again.

Setting of Environment

Return to Start Point

Whether to return to the start point after sewing is finished can be set.

1. Press  twice.

2. Select  by pressing $\triangleleft \triangleright$.



3. Press .

4. Select  by pressing $\triangleleft \triangleright$.



5. Select whether to validate a return to the start point by pressing .



When the start point return is valid



When the start point return is invalid

6. Press .

Modified setting is saved and the previous screen is displayed again.

Speed Range

For setting whether to reflect modified machine speed to all needle bars.

1. Press  twice.

2. Select  by pressing $\triangleleft \triangleright$.



3. Press .

4. Select  by pressing $\triangleleft \triangleright$.



5. Modify setting by pressing .

Press  for invalidating the modification.



6. Press .

Modified setting is saved and the previous screen is displayed again.

Checking the Embroidery Area

The embroidery area can be checked according to the following procedure.

- The following two checking methods (rectangle and octagon) can be selected.

Item	Contents
	Checking by rectangle tracing
	Checking by octagon tracing

1. Press  twice.

2. Select  with $\triangleleft \triangleright$.



3. Press .

4. Press $\triangleleft \triangleright$ to select .



5. Press  to change the settings.



Checking with the rectangle



Checking with the octagon

6. Press .

The changed settings are stored and the previous screen is displayed.

Feed rate adjustment

A feed rate is adjustable.

- A feed rate can be set in the range of "1 (normal)" to "5 (slow)".
- This function is previously set to "1" upon shipment.

1. Press  twice.

2. Select  with  .



3. Press .

4. Select the desired feed rate with  .



5. Press .

The new feed rate is saved. The previous screen appears.

Setting of RS-232C Communication Speed

Speed for transferring embroidery data between the operation panel and a personal computer with BE-100 installed.

- The transmission speed can be selected within the range of 9600, 19200, 38400 and 115200. (unit : bps)

1. Press  twice.

2. Select  by pressing  .



3. Press .



4. Select [RS Speed] by pressing Δ / ∇ .



5. Select communication speed by pressing \triangleleft / \triangleright .

6. Press **END**.

Modified setting is saved and the previous screen is displayed again.

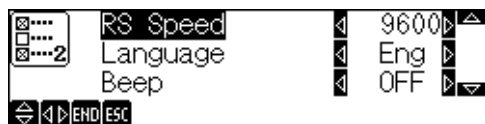

Display Language

A language to display on the screen can be set.

- The following languages can be selected.

Display	Contents
JPN	Japanese
Eng	English
Españl	Spanish
fr.	French

1. Press **ENV** twice.

2. Select **Environment 1** by pressing \triangleleft / \triangleright .



3. Press **ENTER**.



4. Select [Language] by pressing Δ / ∇ .

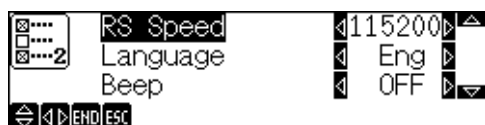

5. Select a language to display by pressing ◀▶.



6. Press **END**.

The previous screen is displayed again with a display in a selected language.

Alarm Sound

Whether to generate a sound in case of an error can be set.

- The following sounds can be set.

ON	A sound is generated until the error is reset.
OFF	A sound is generated twice.
5	A sound is generated five times.

1. Press **ENV** twice.

2. Select **ENV** by pressing ◀▶.



3. Press **ENTER**.



4. Select [Beep] by pressing ▲▼.



5. Select a kind of sound by pressing ◀▶.

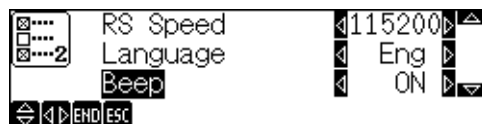

6. Press **END**.

Modified setting is saved and the previous screen is displayed again.

Motive Speed

The startup speed of the main shaft can be set.

- The following startup speed can be set.

NOMAL	Starts up the main shaft at the normal speed.
UP	Speeds up the startup speed of the main shaft.
CAP	Speeds up the startup speed of the main shaft when using the cap frame.
FLAT	Speeds up the startup speed of the main shaft when using a frame other than the cap frame.

1. Press  twice.

2. Select  with \leftarrow \rightarrow .



3. Press .



4. Select "Motive Speed" with \triangle ∇ .

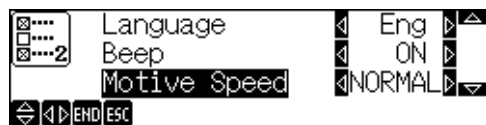

5. Select the type of the startup speed of the main shaft with \leftarrow \rightarrow .

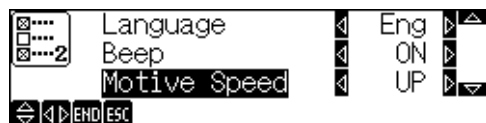

6. Press the  button.

The changed settings are stored and the previous screen is displayed.

Small-Pitch Deletion

Stitches less than preset can be deleted.

- Settings in the range of OFF to 1.0 mm (in units of 0.1 mm) are valid. When OFF is chosen, stitch deletion is not carried out.
- This function is previously set to "OFF" upon shipment.

1. Press  twice.

2. Select  with \triangleleft \triangleright .



3. Press .



4. Select "Del. small stch" with \triangle ∇ .

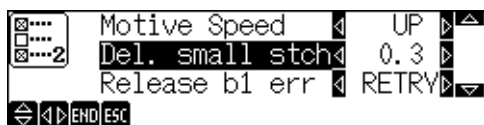

5. Select the maximum stitch to be deleted with \triangleleft \triangleright .

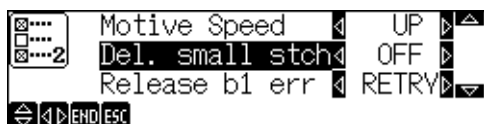

6. Press .

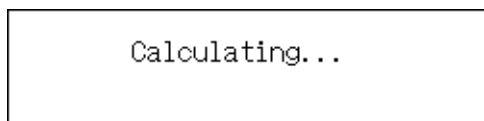

The new setting is saved and calculation is performed. The previous screen is displayed. For example, if 0.3 mm is set, stitches shorter than 0.3 mm are deleted.

XY Feed Power Increase

The frame movement power for positioning before starting embroidering can be switched.

- The following settings can be set.

NOMAL	Frame movement at normal power. (by the jog switches)
UP	Frame movement at increased power (by the jog switches)

- This setting is not valid to the frame feed during embroidering.

1. Press  twice.

2. Select  with $\triangleleft \triangleright$.



3. Press .

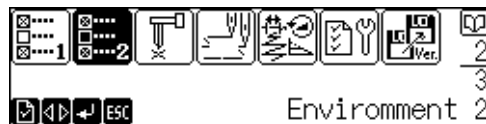

4. Select "XY power" with $\triangle \nabla$.

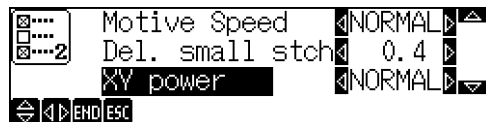

5. Select the XY feed power with $\triangleleft \triangleright$.

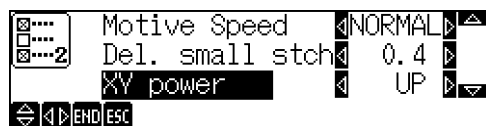

6. Press .

The new setting is saved and the previous screen is displayed.

Boring

Whether to validate or invalidate the boring mode and to shift data in case of boring can be set.

- This setting is available only for sewing data which has been created for boring.
- The machine itself cannot check if the sewing data is for boring or not. Therefore, make sure to check the data before starting sewing.
- Mount the following optional accessories on the machine before starting sewing.
 - Boring knife
 - Needle plate for boring, Finger guard
- If editing including enlargement, reduction or rotation is done using sewing data created for boring, the correct sewing may not be available.
- This function is previously set to :
 - Boring mode valid/invalid : invalid
 - Data shift valid/invalid : invalid

Validation/Invalidation of Boring Mode

1. Press  twice.

2. Select  by pressing  .



3. Press .



4. Select  by pressing  .



5. Validate or invalidate the boring mode by pressing .



When the boring mode is valid



When the boring mode is invalid

Validation/Invalidation of Data Shift

1. Press  twice.

2. Select  by pressing $\leftarrow \rightarrow$.



3. Press .



4. Select  by pressing $\leftarrow \rightarrow$.



5. Validate or invalidate the data shift by pressing .



When the data shift is valid



When the data shift is invalid

6. Press .

Modified setting is saved and the previous screen is displayed again.

Lock Stitch

Lock stitch can be set at the sewing start and end positions and sewing start position after trimming thread.

Setting lock stitch at the sewing start position



1. Press  twice.

2. Select  with $\leftarrow \rightarrow$.



3. Press .



4. Select  with  .



5. Press  to validate or invalidate the lock stitch.

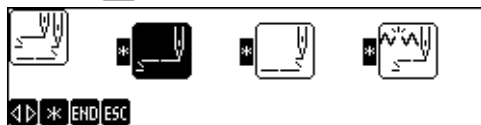

Validating the lock stitch





Invalidating the lock stitch

6. Press the  button.

The changed settings are stored and the previous screen is displayed.

Setting the lock stitch on the sewing send position



1. Press  twice.

2. Select  with  .



3. Press .



4. Select  with  .

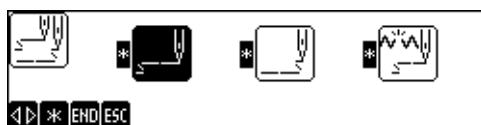

5. Press ***** to validate or invalidate the lock stitch.



Validating the lock stitch



Invalidating the lock stitch

6. Press the **END** button.

The changed settings are stored and the previous screen is displayed.

Setting the lock stitch at the sewing start position after thread trimming

1. Press twice.

2. Select with .



3. Press .



4. Select with .

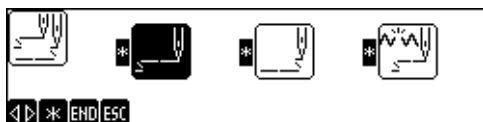

5. Press ***** to validate or invalidate the lock stitch.

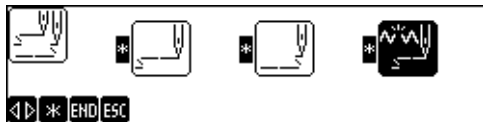

Validating the lock stitch

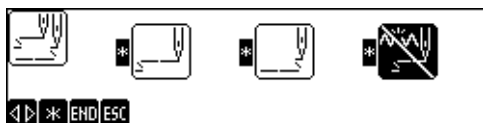

Invalidating the lock stitch

6. Press the **END** button.

The changed settings are stored and the previous screen is displayed.

Speed Limit in a Short Pitch

Speed can be limited when stitching in a designated pitch.

- The pitch can be designated between 0.0 and 2.0 mm in units of 0.1 mm.
- The speed can be set from 550 rpm to the maximum speed available for the current frame in units of 10 rpm.

1. Press  twice.

2. Select  with $\triangleleft \triangleright$.



3. Press .



4. Designate the stitch length to be limited with $\triangleleft \triangleright$.

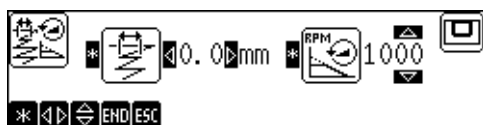

5. Designate the speed to be limited with $\triangle \nabla$.

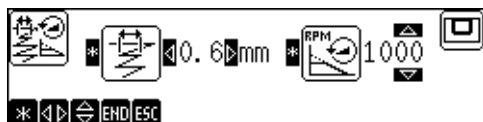

6. Press the  button.

The changed settings are stored and the previous screen is displayed.

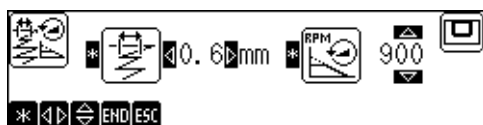

Invalidating speed limit in a short pitch

1. Press the  button after the setting screen is displayed.

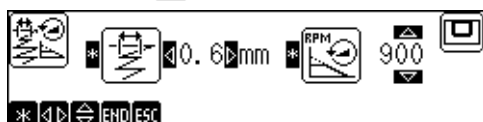

2. Press the **END** button.

The changed settings are stored and the previous screen is displayed.

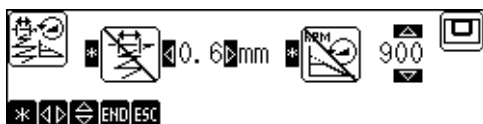

Feed Timing

The timing of needle drop and hoop movement can be adjusted according to the cloth thickness.

- Either thick or thin cloth can be selected. Thin cloth is set as the standard thickness.

1. Press  three times.

2. Select  with $\leftarrow \rightarrow$.

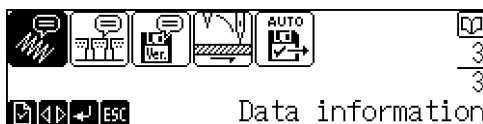

3. Press .



4. Select the thickness with $\leftarrow \rightarrow$.



5. Press the **END** button.



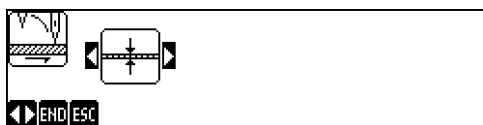









The changed settings are stored and the previous screen is displayed.



Automatic Input Setting

Sewing data can be read from a floppy disk or a computer automatically or semiautomatically.

■ The following items can be selected.

Item	Contents
	Choose whether or not to read sewing data automatically. <ul style="list-style-type: none">  Reads data manually.  Reads data from a floppy disk automatically.  Reads data from a floppy disk semiautomatically.  Reads data from a computer automatically.  Reads data from a computer semiautomatically.
	Choose whether or not to continue data reading from the start automatically on completion of sewing. <ul style="list-style-type: none">  Discontinues data reading on completion of sewing.  Continues data reading from the start automatically on completion of sewing.
	Choose whether or not to reflect the initial edit data also in sewing operations according to other data. <ul style="list-style-type: none">  The initial edit data is reflected.  The initial edit data is not reflected.

1. Press  three times.

2. Select  with  .

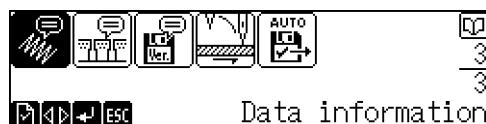



3. Press .





4. Choose "MANU," "AUTO," or "S-AUTO" with ◀▶.



The following steps are not necessary when  is selected.

Go to step 8 when you select  .

Go to step 5 when you select  .

5. Select  with ◀▶.



6. Press  and choose whether or not to continue data reading from the start automatically on completion of sewing.

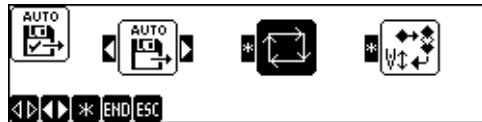

7. Select  with ◀▶.

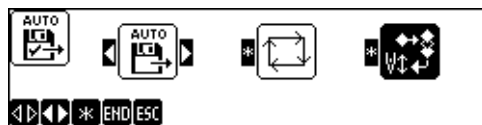

8. Press  and choose whether or not to reflect the initial edit data also in operations according to other data.

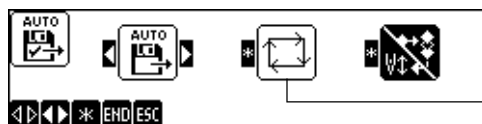

This does not appear when "S-AUTO" is selected in step 4.

9. For reading data from a floppy disk, insert the floppy disk into the operation panel.

For reading data from a computer, establish connection with it.

10. Press .

11. Select the desired sewing data item with ▲▼◀▶, and press .



"AUTO" or "S-AUTO" appears.





12. Press  . Sewing starts.



"AUTO" or "S-AT" appears.

13. When sewing is complete, press  .

In the automatic mode, the next data is read and the machine is brought to a state of standby. In the semi-automatic mode, the next sewing data is selected. Select the desired data with

    and press  .



14. To discontinue sewing by automatic input, follow steps 1 to 4 and select

 . Press  .







Display of Information

Information about the machine and patterns can be displayed on the screen.

Pattern Information

Detailed information about a selected pattern can be checked.

■ Contents of information to be displayed are as shown below.

	Size of sewing data (mm)
	Coordinates of embroidering start point
	Coordinates of embroidering end point
	Number of stitches
	Number of colors
	Name of data

1. Press  three times.

2. Select  by pressing  .

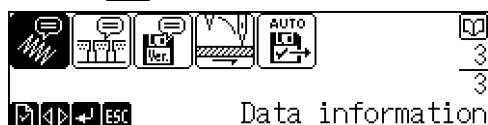

3. Press .

4. Check information about patterns.

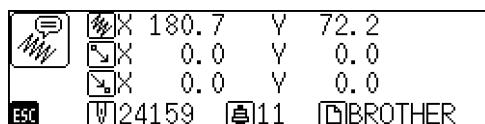





5. Press .

The previous screen is displayed again.

Features of Machine

Detailed information of the machine can be checked.

■ Contents of information to be displayed are as shown below.

	Maximum moving range of flat hoop
	Maximum moving range of cap hoop
	Number of heads
	Number of needle bars per head

1. Press  three times.

2. Select  by pressing  .

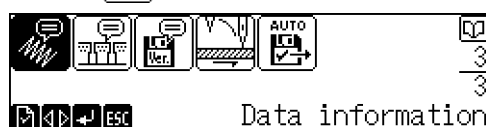

3. Press .



4. Check information about the machine.







5. Press .

The previous screen is displayed again.

Information about Versions

Information about CPU ROM version, etc. can be checked.

■ Contents of information to be displayed are as shown below.

	Panel CPU ROM version
	Main CPU ROM version
	Upper axis CPU ROM version
	Interface CPU ROM version
	Feed wave form table version

1. Press  three times.

2. Select  by pressing  .



3. Press .



4. Check information about versions.

The version is displayed by numerical figures (1 ~ 255).

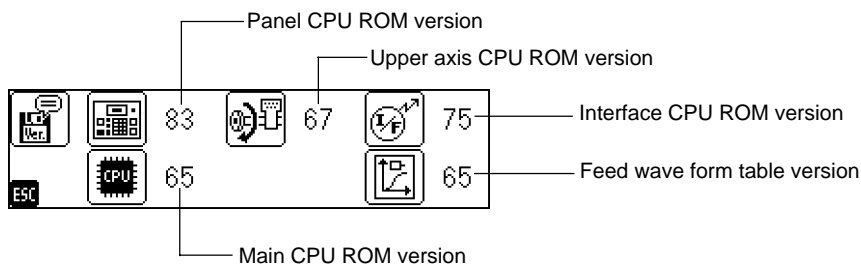

5. Press .

The previous screen is displayed again.



Chapter 6 Operation of Machine

1. Operating Procedures

1-1 Power Source

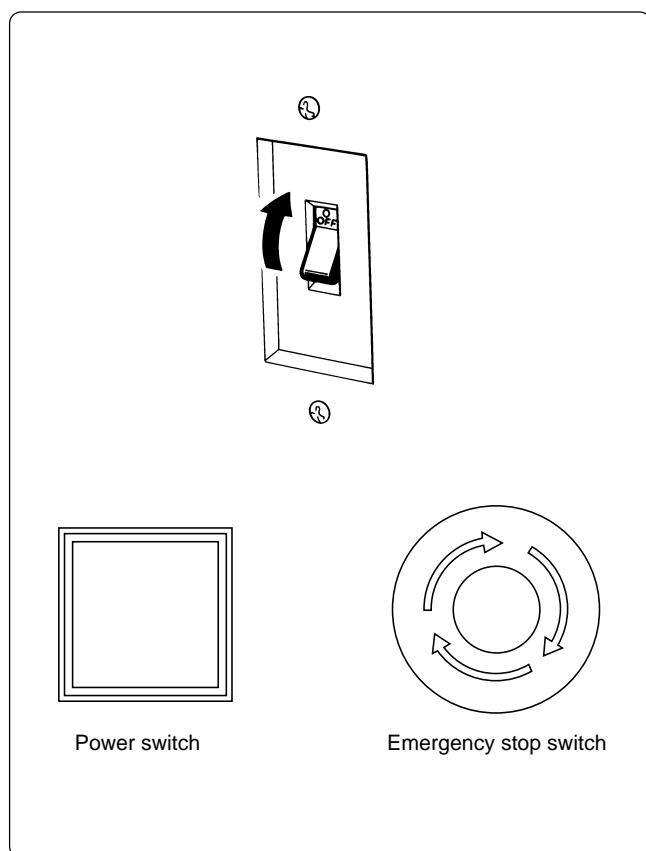

1. Turn the power on to the machine.
2. When the machine is equipped with the shut-off switch unit, Reset the emergency stop button.
3. When the machine is equipped with the shut-off switch unit, Press the power switch.
4. A message is displayed on the LCD.



- The alarm sounds three times and the needle bar and the presser foot move upward. Then the hoop moves to the zero point and the sewing data screen is displayed.

Note) When turning the power off and back it on again, wait for at least 10 seconds.

1-2 Preparation for Embroidering

- Select embroidering data.
- Using the jog switches ($\triangle \nabla \triangleleft \triangleright$), determine a position to start embroidering.
Note) An error message is displayed on the LCD if a pattern comes out of the hoop.
- Pressing  starts embroidering.
- After embroidering is finished, the machine is placed in the stand-by state.

2. Machine Stop

2-1 Stopping the Machine with the stop switch unit

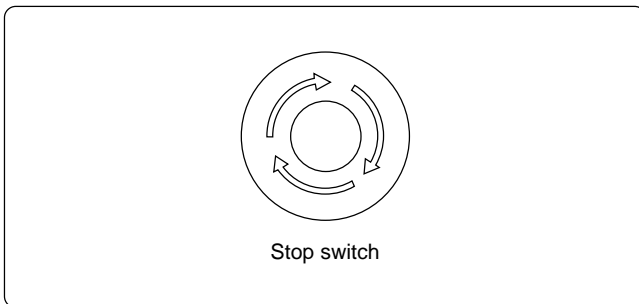

Press the stop switch (option) or  to stop the operation of the machine.

The stop switch adopts the push-lock method.

■ Resetting Machine Stop

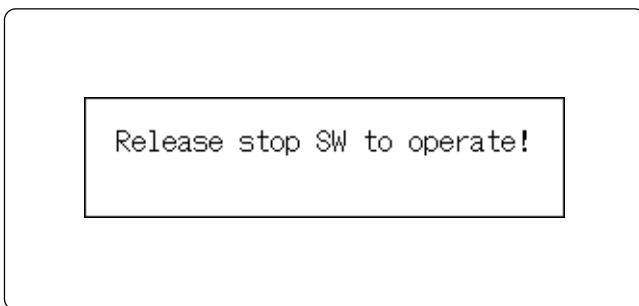

- When the stop switch (option) is locked, the message, "Release stop SW to operate!", is displayed on the operation panel.
- To reset the stop switch, turn it counter-clockwise. The knob of the switch pops up and machine stop is reset.

2-2 Emergency Stop of the Machine with the shut-off switch unit

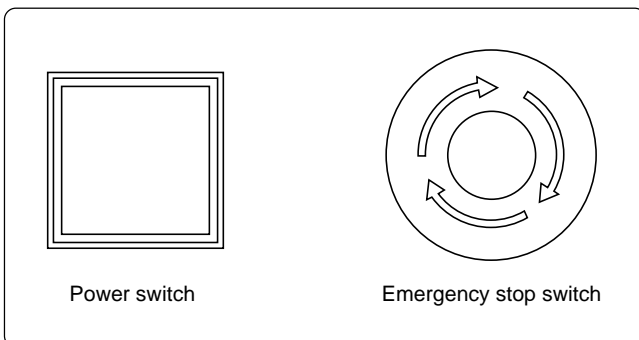

When the emergency stop switch (option) is pressed, all power except that for the fluorescent lamp is turned off.

■ Resetting Emergency Stop (shut-off)

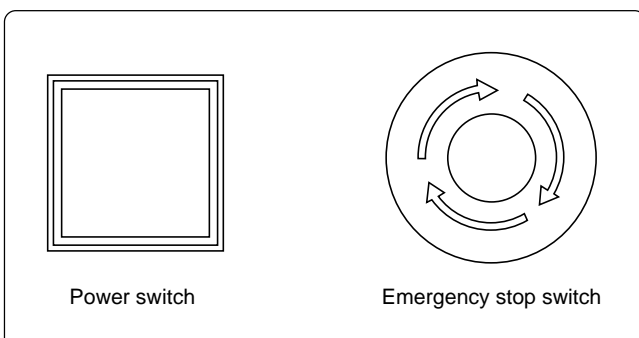

When turning the emergency stop switch in the direction of the arrow illustrated on the switch, the knob of the switch pops up and emergency stop is reset.

Press the power switch to turn on the power again.

3. Hoop Feed Position

- In order to ease mounting and dismounting of the embroidery hoop, another needle position can be set as a hoop feed position in the movable area additionally to the current needle position.
- In order to ease material attachment while operation is suspended, the hoop can be moved to the feed position at any time by the hoop feed switch.
- The hoop can also be moved to the feed position automatically after embroidering is finished. Refer to "Hoop Automatic Retract" on Page 89 for details.



4. Area Check

4-1 External Tracing

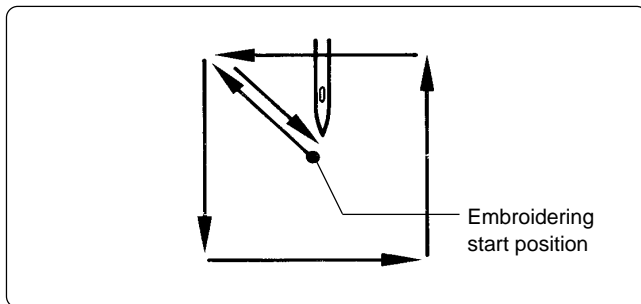

- If the check switch is pressed in other cases than "area over", the rectangular outline of the pattern is traced.



Note) The outline of pattern can be checked in rectangle or octagon by setting "Checking embroidery area" in "Environment 1".

4-2 Automatic Hoop Movement in Area

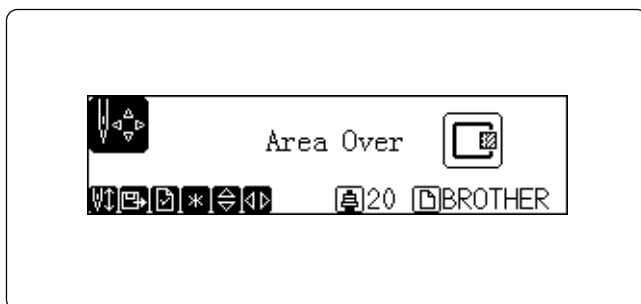
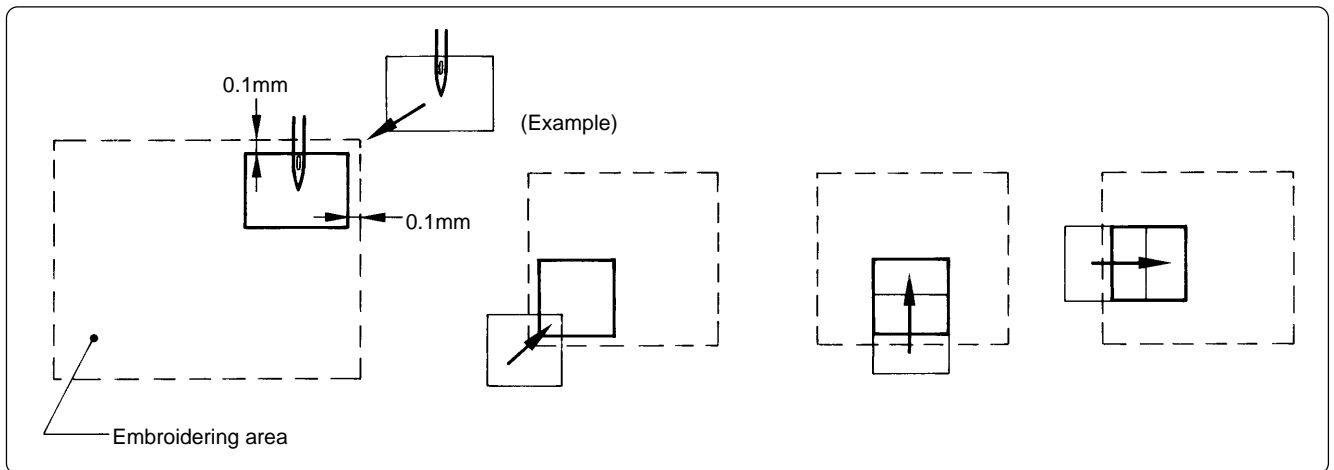

- If "area over" is displayed, press the check switch. The hoop automatically moves inside the embroidering area, where the pattern is set, at the nearest position.



Note) After finishing the movement inside the area by this function, execute external tracing. Then, check that the needle and the presser foot do not interfere with the hoop before starting embroidering.

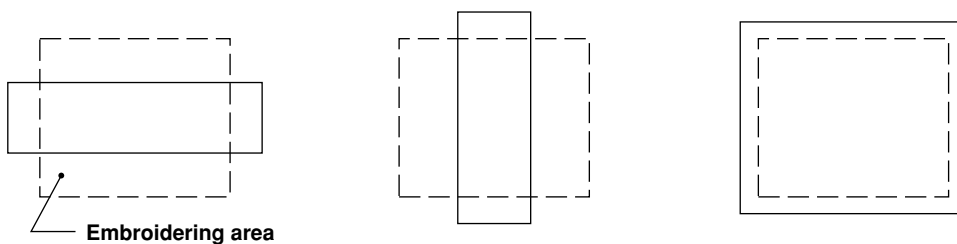

If the pattern is not held in the embroidering area as shown below, the hoop cannot move into the area. Enlarge the embroidering area on the operation panel.

5. Jog Switches

5-1 Hoop Movement to Start Position

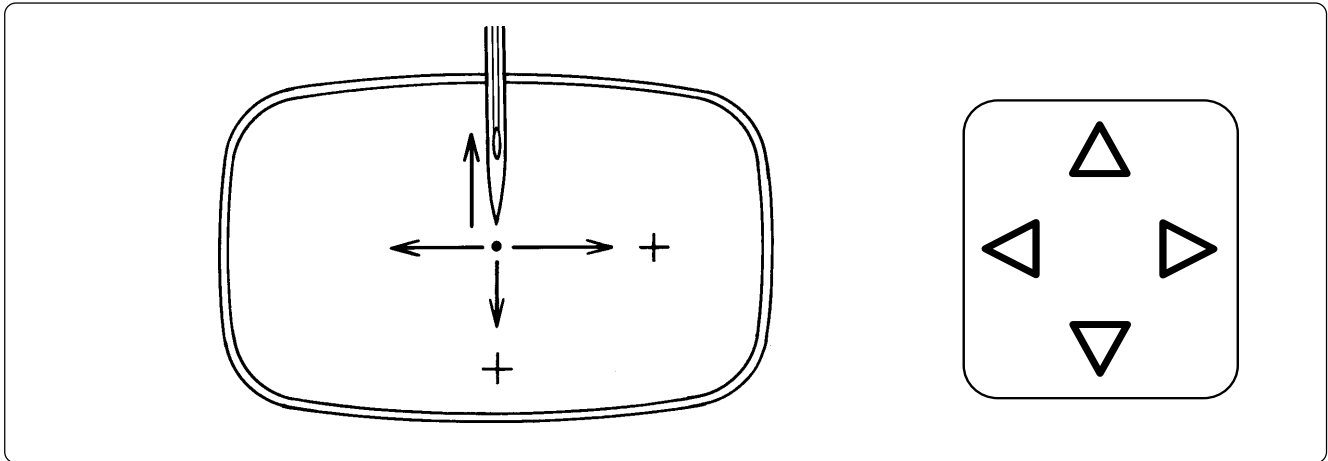

The hoop can be moved before starting embroidering and the start position can be set arbitrarily.

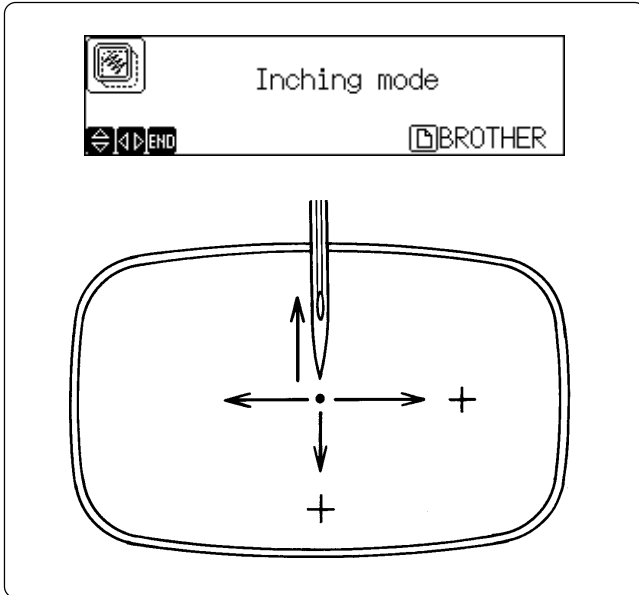

5-2 Inching Mode during Embroidering (Forcible Hoop Movement)

- Note) • Moving the frame greatly in the inching mode may cause an interference with the machine. Pay utmost care in the inching mode.
- Although the distance of the frame moved in the inching mode is stored even after turning OFF the power, if the power is turned ON again and sewing is started, the pattern may be embroidered in a different position. Be sure to use the inching mode appropriately.



1. Press the  while pressing the  switch in order to select the inching mode.
2. Press the jog switch and the hoop moves to the direction of the pressed switch.

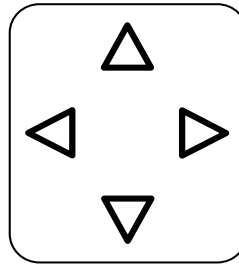

- Note) • Note that the forcible hoop movement will produce deviation of embroidering by the amount.
- If the hoop and material are deviated from each other during embroidering, correct it by using the jog switches.

3. Pressing the "END" switch resets the inching mode.



4. Press the "START" switch restarts embroidering.

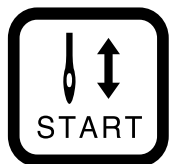

6. Detection of Home Position

After the home position is detected, the hoop returns to the initial position.

1. Press **0** while pressing **STOP** with the machine stopped.



Initial screen

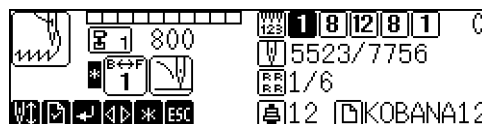

Temporary stop screen

2. The hoop moves and the home position is detected.

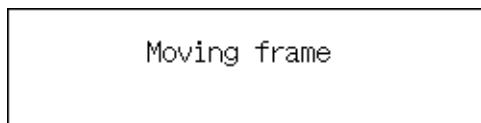
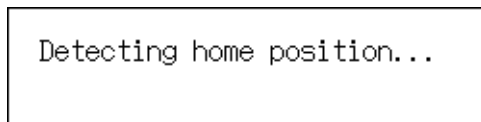
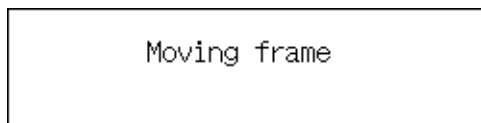

3. The initial screen is displayed again.



Chapter 7 Maintenance

⚠ CAUTION

- ⚠
 Turn off the power switch before starting maintenance.
 Failure to do so may start the machine unintentionally through an accidental activation of the START switch, resulting in bodily injuries.

- ⊘
 Be sure to wear protective goggles and gloves when handling the lubricating oil or grease, so that no oil or grease gets into your eyes or onto your skin, otherwise inflammation can result.
 Furthermore, do not drink the oil or grease under any circumstances, as they can cause vomiting and diarrhoea.
 Keep the oil out of the reach of children.

- Keep the machine clean at all times to prevent machine trouble.
- Keep the machine clean.
 Remove dirt with a soft, dry cloth. If necessary, clean with the detergent-soaked cloth, then wipe off the detergent with a cloth dampened with (hot) water.
- Caution
 Never use benzene or thinner for cleaning the machine.

1. Cleaning

1-1 Cleaning and Lubrication of Rotary Hook

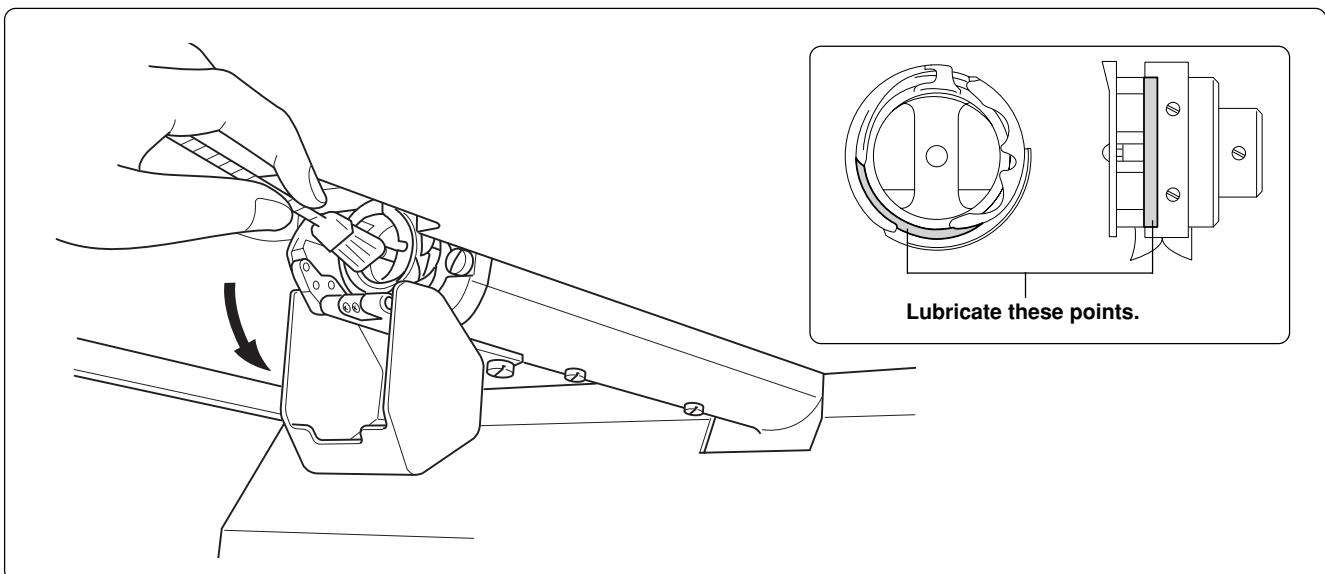

- Clean rotary hooks daily using the brush provided. If a rotary hook is too dirty, cleaning with a compressor (compressed air) is recommended.
- If thread breakage or rotary hook noise occurs during embroidering, lubricate the race of the rotary hook.
 - Note) • Use the dropper provided to supply oil. Use BROTHER's embroidery machine oil (equivalent to Nisseki Sewing Lub No. 10).
 - Supply a proper amount of oil. Any excess may stain fabrics, etc.

1-2 Cleaning of Needle Plate

Broken threads left around the movable or fixed knives or the thread holding plate may result in thread trimming failure or parts damage. Clean them once a month.

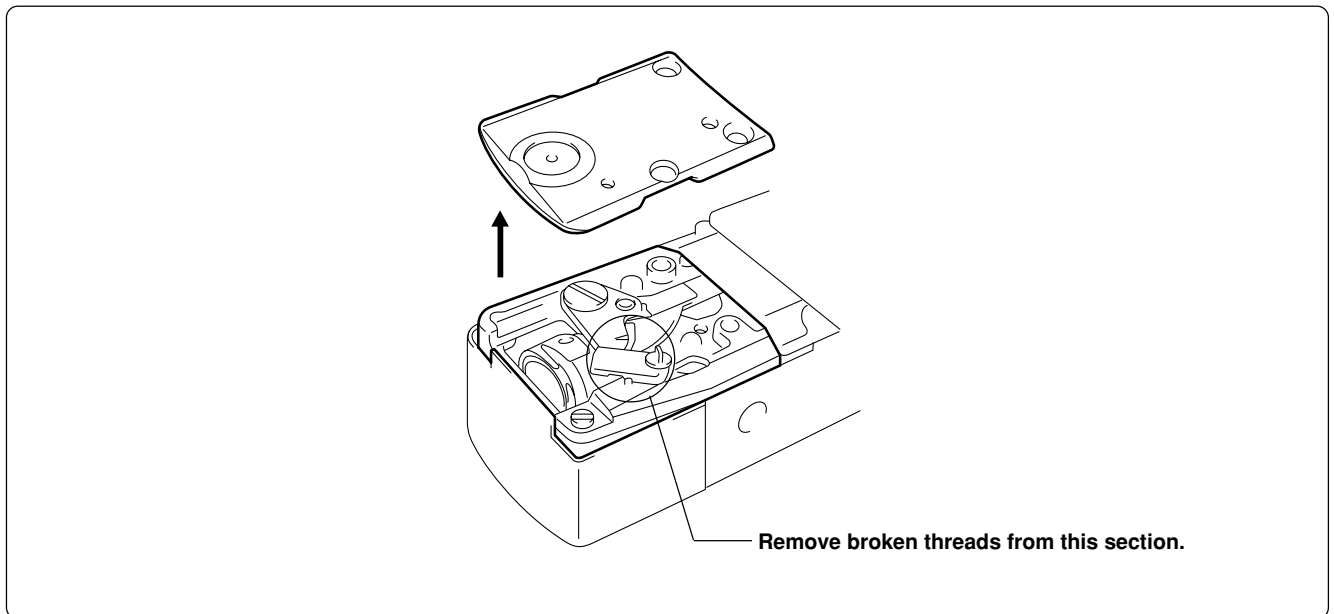

2. Oiling

To extend the machine's service life, supply oil to the following places at regular intervals. The models BES-116AC adopt centralized wick lubrication (including rotary hooks). Before daily operation, supply oil as needed while checking the oil level through the oil window.

- (Note)
- When oiling, be sure to supply Brother's machine oil (Nisseki Sewing Lube #10 or the equivalent) using the dropper.
 - Excessive oiling may cause the material to be stained.
 - Lubricate the rotary hook.

2-1 Head

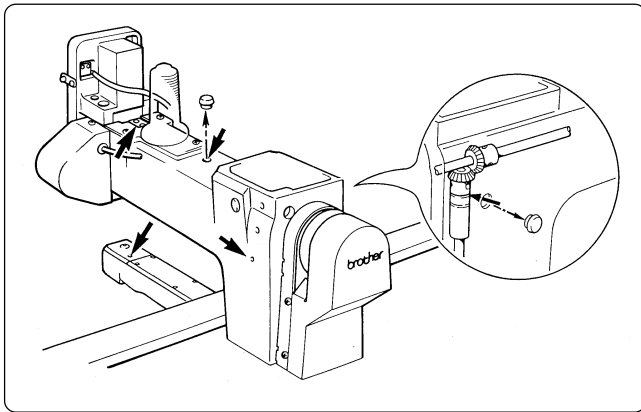

When the machine has been unpacked or has not been used over a prolonged period, supply 7 or 8 drops of oil to the points indicated by the arrows in the figure before starting operation.

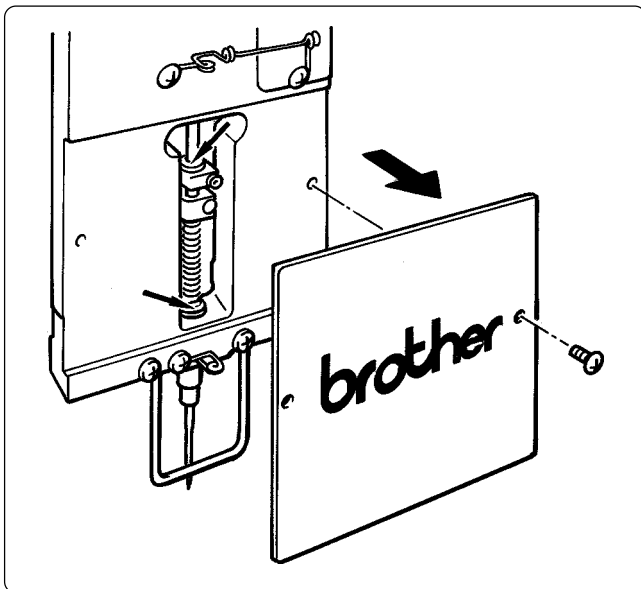

Supply oil to the top and the bottom of needle bar daily as shown in the figure.

■ Daily oiling

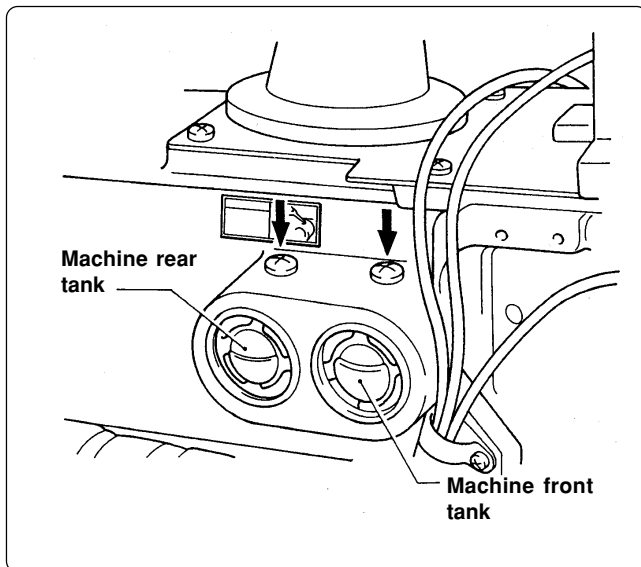

Supply oil to the points indicated by the arrows in the figure.

- Note)
- Refill the machine front tank with oil once a week.
 - The machine front tank may run dry in one or two hours. Since the tank contains an oil storage device, it lubricates the machine gradually even if the tank is empty.

■ Before operation

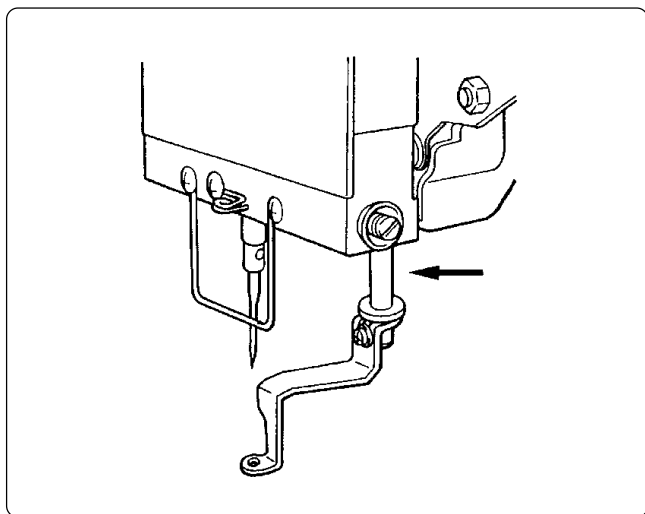

Before starting operation of the machine, use a cloth to wipe greasy dirt off the needle bar guide rail and the pressure foot shaft (indicated by the arrows in the figure) from the rear of the needle bar case.



Chapter 8 Adjustment

⚠ CAUTION



Turn off the power switch and pull out the plug before starting adjustment. Failure to do so may start the machine unintentionally through an accidental activation of the START switch, resulting in bodily injuries.

• Adjustment



If adjustment should be made while the power switch is turned on, pay special attention to your safety.



Maintenance and inspection of the machine should be conducted only by trained engineers.

1. Adjusting Needle Bar Height

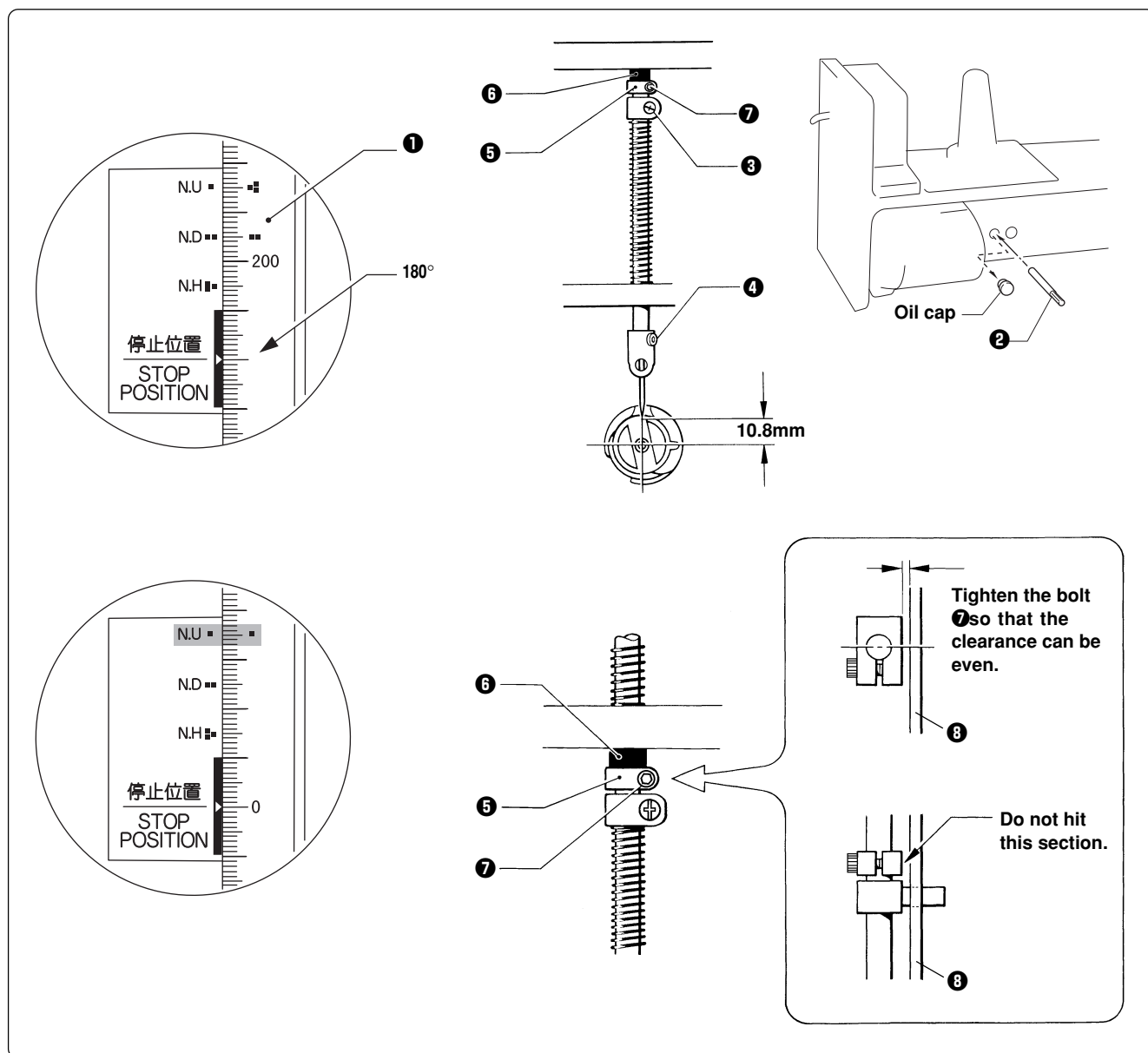

1. Turn the pulley ❶ until the pulley scale indicates 180° and the needle bar is set at the lowest position. (The pulley "■" mark and the stop mark "■" are aligned.)
2. Insert the positioning bar ❷ into the hole in the side of machine head and fix the upper shaft.
Note) Turn the pulley securely in the clockwise direction to eliminate a backlash.
3. Loosen Needle bar guide bracket set screw ❸ and the bolt ❷ of the top dead center stopper ❺ when the needle tip is positioned 10.8 mm above the center of the rotary hook shaft. Adjust the position of the needle bar thread guide so that the set screw ❹ on it is turned to the right by 25 ~ 30°. Tighten Needle bar guide bracket set screw ❸ securely.
Note) When tightening the needle bar clamp set screw ❸, the hole in the needle bar guide should face the front.
4. After adjustment is finished, remove the positioning bar ❷.
5. Set the needle bar at the highest position (where the pulley indication mark "■" and the cover indication mark "■" are aligned). Lightly press the top dead center stopper ❺ toward the cushion rubber ❻, and tighten Socket head bolt for top dead center stopper ❷ while pressing down the needle bar clamp so that it faces the front.
Note) • Make sure that the top dead center stopper ❺ does not hit the needle bar guide rail ❸ at this time.
• Remove the positioning bar ❷ from the machine head after adjustment is finished.

■ When using the bottom dead center gauge

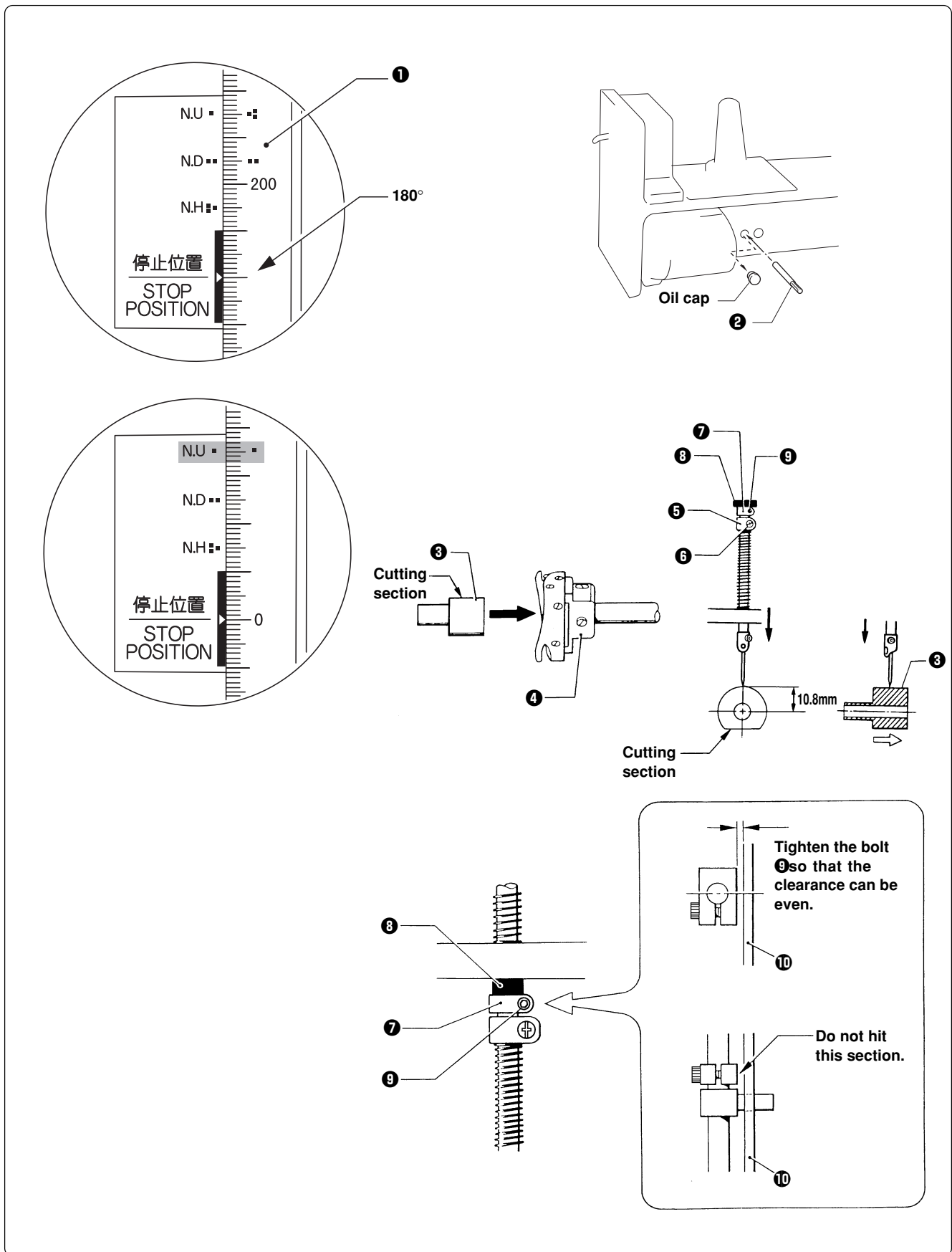

1. Turn the pulley ❶ until the scale of pulley ❶ indicates 180° (where the pulley indication mark "■" and the stop mark "■" are aligned) and the needle bar is set at the lowest position.
2. Insert the positioning bar ❷ into the hole in the side of the machine head and fix the upper shaft.
Note) Turn the pulley securely in the clockwise direction.
3. Insert the bottom dead center gauge ❸ into the rotary hook ❹.
4. Loosen the screw ❺ of the needle bar clamp ❽, then move the needle bar up and down until the needle tip touches the gauge ❸ lightly.
Note) • The needle point should touch the gauge at a place other than the cutting section.
• The bottom dead center gauge should be set in or removed from the rotary hook with its cutting section facing upward.
5. Tighten the screw ❻ of the needle bar clamp ❽ securely.
6. After adjustment is finished, remove the positioning bar ❷.
7. Set the needle bar at the highest position (where the pulley indication mark "■" and the cover indication mark "■" are aligned). Lightly press the top dead center stopper ❿ toward the cushion rubber ❻, and tighten Socket head bolt for top dead center stopper ⓫ while pressing down the needle bar clamp so that it faces the front.
Note) • Make sure that the top dead center stopper ❿ does not hit the needle bar guide rail ⓬ at this time.
• Remove the positioning bar ❷ from the machine head after adjustment is finished.

2. Adjustment of Timing Between Needle and Rotary Hook

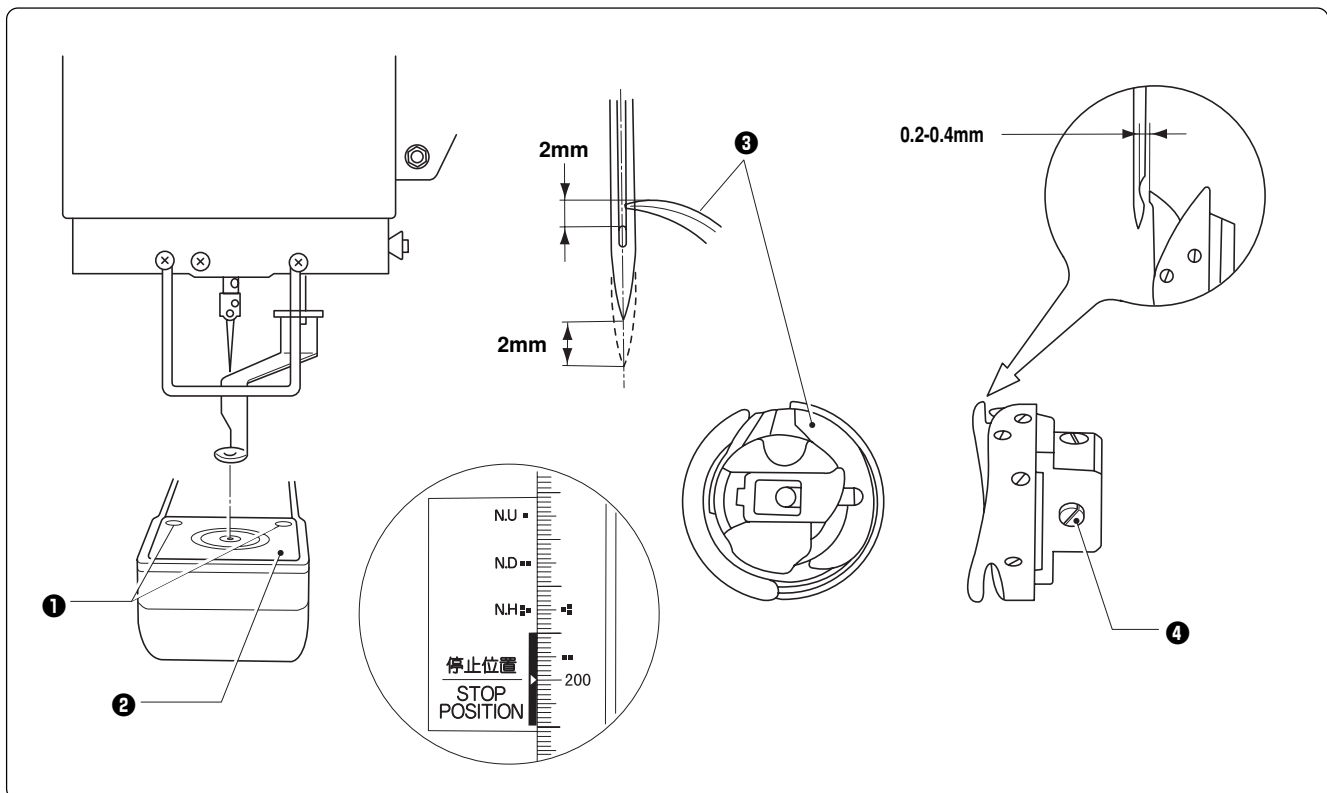

1. Remove two flat countersunk head screws ❶, and remove needle plate ❷.
2. Make an adjustment so that the needle is brought to rotary hook ❸ when it rises 2 mm from the needle bar bottom point (180°) (in the position where the mark "■" of the pulley is aligned with the stop mark "■").
3. Loosen screws ❹ of the rotary hook. Adjust the clearance between the needle and the rotary hook to 0.2 to 0.4 mm. Tighten the two screws temporarily. The needle bar height will be about 2 mm (Figure A).

3. Adjustment of Presser Foot Height

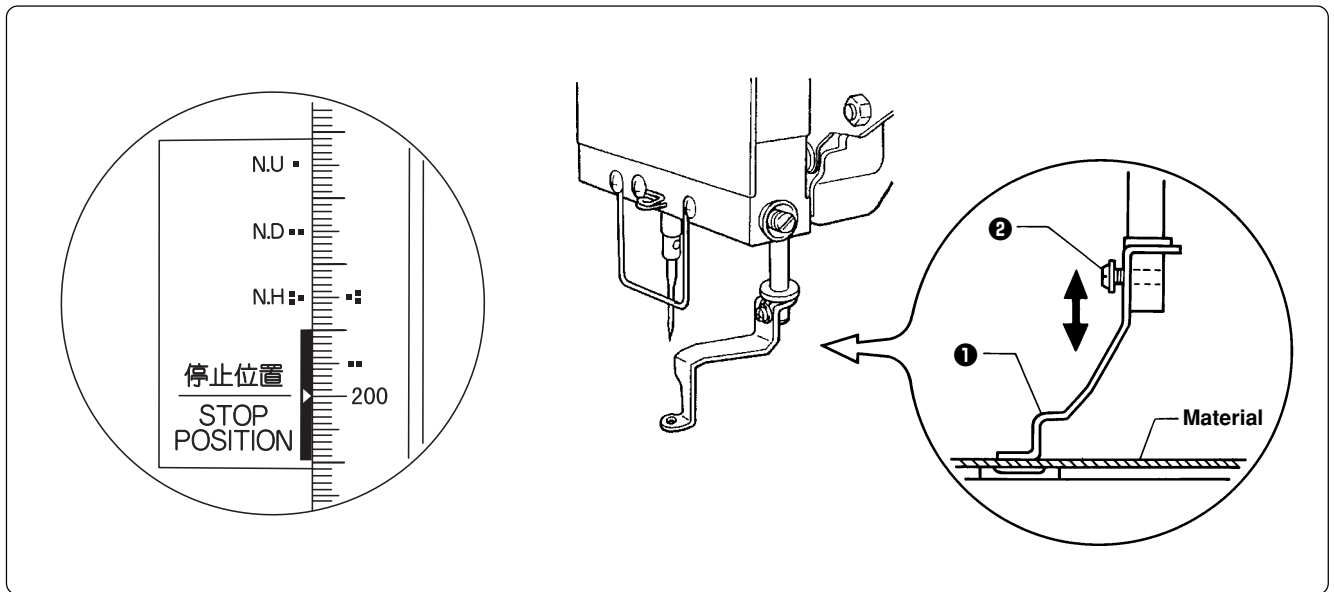

Loosen the screw ② of the presser foot ①, and adjust the presser foot ① until it comes above the cloth top surface when it is at the alignment position (where the pulley B indication mark "■" and the cover indication mark "■" are aligned).

Note) When turning on the power switch, lower the presser foot ① with the lever.

4. Adjustment of Thread Trimmer

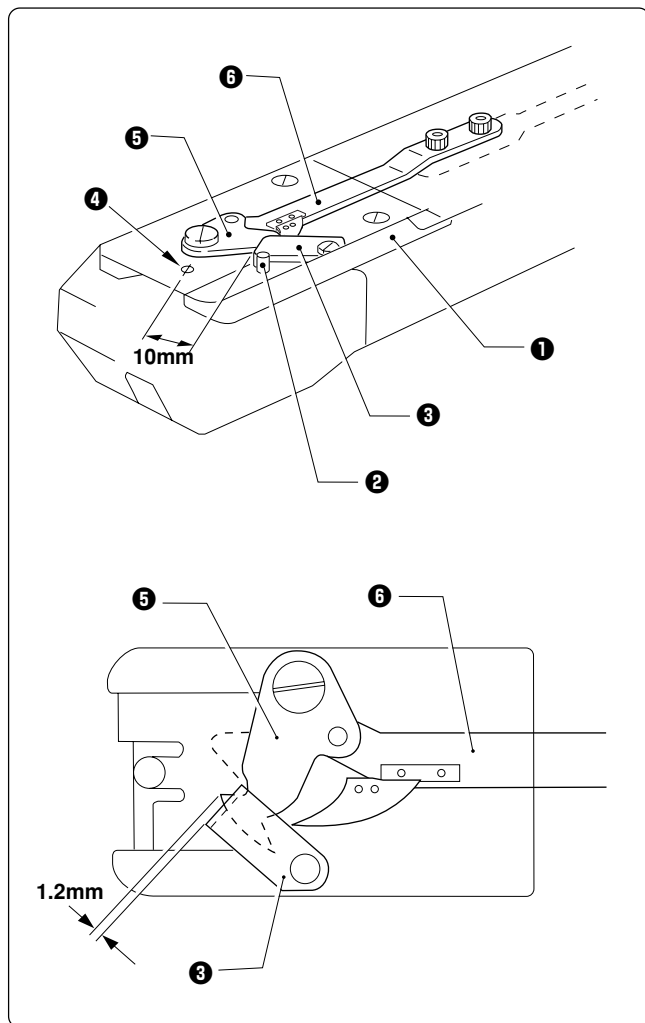

1. Bring fixed knife ③ into contact with spring pin ② of needle plate base ①, and tighten the screw.

When attaching fixed knife ③ adjust the distance from the knife to hole ④ of the needle plate to 10 mm.

2. Advance movable knife ⑤ from fixed knife ③ by 1.2 mm. Adjust thread trimmer connecting rod ⑥ so as to keep the same condition even after thread trimming.

5. Adjusting the Belt Tension

The belt Tension is adjusted to the optimum tension at the time of shipment from the factory. However, as the belt is used, it becomes run in and may loosen around the machine pulley and motor pulley . Use the following procedure to check the belt tension.

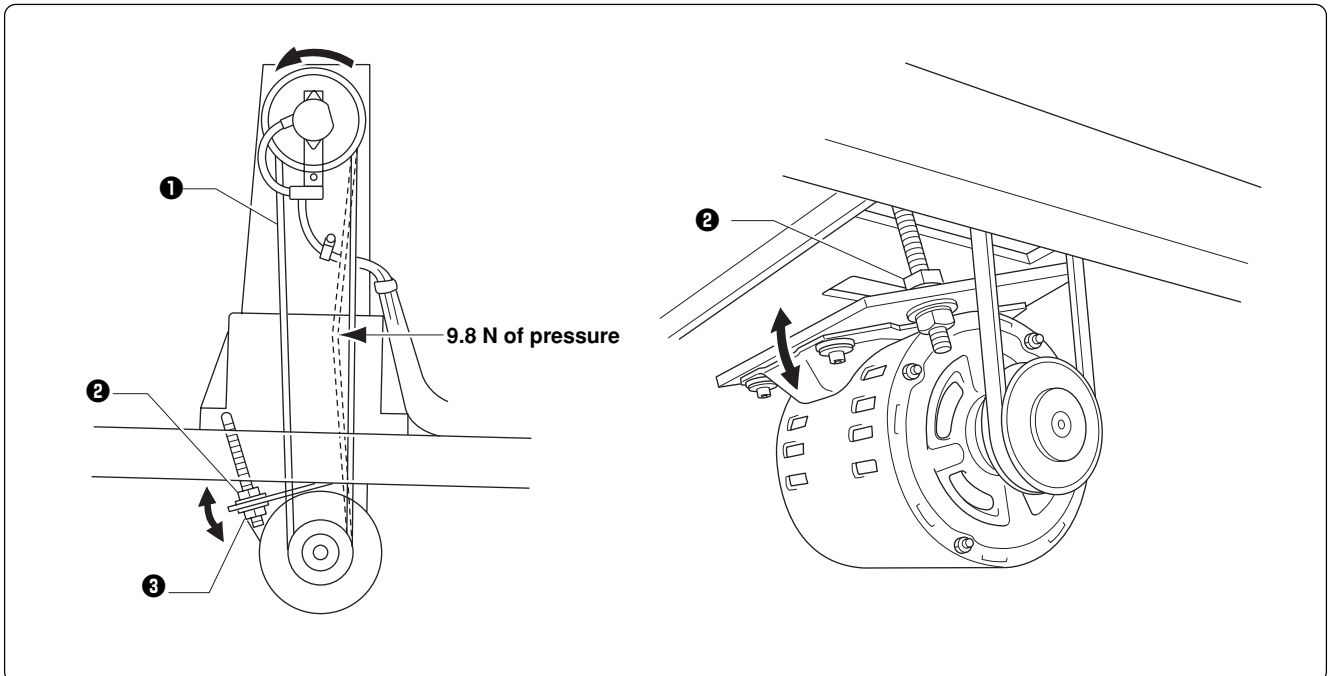





































Bring a push-pull into contact with belt ①. Adjust the deflection of the belt to 8 mm when a 9.8 N pressure is applied. Loosen nut ② and adjust nut ③ for proper deflection.

The machine operating direction is counterclockwise when seen from the machine pulley end.



Chapter 9 Error code list

Code	Error Messages	Error	Measures
E-00	ERROR 00	No error occurs.	This is not usually displayed.
E-01	ERROR 01	Either motor of main shaft, X- or Y-axis has locked.	
E-02	Overtravel	Overtravel occurs during home position detecting movement.	Turn the power off and on once. If the same error occurs again, the area sensor is faulty.
E-03	Stop SW was pressed during home positioning	The stop switch is pressed during home position detecting movement.	Press the  to restart the home position detecting movement again.
E-04	Zero positioning is out of range	Zero detecting movement out of range	Turn the power off and on once. If the same error occurs again, the home position sensor is faulty.
E-05	Needle stop position error	Needle stop position error	Adjust the pulley stop position (100 degrees) above the needle and press the  .
E-09	X-axis home position error	X-axis home position detection error	Turn the power off and on once. If the same error occurs again, the X-axis mechanism is faulty.
E-0A	Thread breakage error	Thread breaking error	After passing through the thread, press the  .
E-0B	ERROR 0B	Stop or emergency stop during sewing	This is not usually displayed.
E-0C	ERROR 0C	Insufficient bobbin thread	
E-0D	ERROR 0D	The machine does not return to the home position.	
E-0F	ERROR 0F	Undefined error	
E-14	Y-axis home position error	Y-axis home position error	Turn the power off and on once. If the same error occurs again, the Y-axis mechanism is faulty.
E-15	Press  for restart.	Stop error during SSP processing (when pressing the stop key while the hoop is moving)	Hoop movement restarts if you press  .
E-16	ERROR 16	Needle with specified number is out of movable area.	This is not usually displayed.
E-17	ERROR 17	Speed Vol. No. is out of range.	
E-1A	ERROR 1A	Destination coordinates error	
E-1C	Restart perimeter	The machine stops during mask tracing.	Tracing is cancelled if the  key is pressed when the machine is stopped during mask tracing. Press the  key to continue tracing.
E-1D	Stop while transferring to next repeat pattern	The machine stops while the needle is moving between patterns during repeat sewing.	This is displayed when the stop switch is pressed while the hoop is moving. Press the  to move the hoop again. (It is necessary to press the  again to start sewing.)
Errors E-1C and E-1D are not displayed due to mechanical problems.			
E-21	Area over 	Hoop overhang(+X)	Pattern or the needle position is out of the embroidering area. Reset the embroidering area on the panel or move the hoop to the sewable position.
E-22	Area over 	Hoop overhang(+Y)	
E-23	Area over 	Hoop overhang(+X, +Y)	
E-24	Area over 	Hoop overhang(-X)	
E-25	Area over 	Hoop overhang(+X, -X)	
E-26	Area over 	Hoop overhang(-X, +Y)	
E-27	Area over 	Hoop overhang(+X, -X, +Y)	
E-28	Area over 	Hoop overhang(-Y)	
E-29	Area over 	Hoop overhang(+X, -Y)	
E-2A	Area over 	Hoop overhang(+Y, -Y)	
E-2B	Area over 	Hoop overhang(+X, +Y, -Y)	

Code	Error Messages	Error	Measures
E-2C	Area over 	Hoop overhang(-X, -Y)	Pattern or the needle position is out of the embroidering area. Reset the embroidering area on the panel or move the hoop to the sewable position.
E-2D	Area over 	Hoop overhang(+X, -X, -Y)	
E-2E	Area over 	Hoop overhang(-X, +Y, -Y)	
E-2F	Area over 	Hoop overhang(+X, -X, +Y, -Y)	
E-31	Area over 	Needle overhang(+X)	
E-32	Area over 	Needle overhang(+Y)	
E-33	Area over 	Needle overhang(+X, +Y)	
E-34	Area over 	Needle overhang(-X)	
E-36	Area over 	Needle overhang(-X, +Y)	
E-38	Area over 	Needle overhang(-Y)	
E-39	Area over 	Needle overhang(+X, -Y)	
E-3C	Area over 	Needle overhang(-X, -Y)	
E-41	This function is not supported. Turn off the power	Invalid start-up error	Turn the power off and on once.
E-42	ERROR 42	XY movement error	Press the  .
E-43	Slave I/F EEPROM read error	Slave I/F EEPROM read error	Turn the power off and on once. If the same error occurs again, the main PC is faulty.
E-A1	Main(Z) motor lock	Spindle motor lock	Press the  . If it occurs frequently, the main shaft mechanism is faulty.
E-A5	ERROR A5	Spindle motor CPU error	This is not usually displayed.
E-A6	ERROR A6	Main shaft motor CPU communication command error	
E-A7	ERROR A7	Main shaft motor CPU send/receive error	
E-A8	ERROR A8	Main shaft stop position signal error	Adjust the pulley stop position (100 degrees) above the needle and press the  . If the error occurs frequently, the parts related to the main shaft stop position sensor are faulty.
E-A9	Spindle CPU parameter error	Spindle CPU parameter error	This is not usually displayed.
E-C1	ERROR C1	Area over during embroidering	Set the embroidering area again on the panel.
E-C3	ERROR C3	Embroidering data buffer empty	This is not usually displayed.
E-C9	Embroidering start error	Embroidering start error	
E-CA	ERROR CA	No sewing permission	
E-CB	Spindle rotation speed error	Spindle rotation speed error	Press the  to cancel the error and press the  . If the same error occurs again, there is a possibility that the spindle is overloaded.
E-CD	ERROR CD	Speed command can not be received.	Turn the power off and on once. If the same error occurs again, the main PCB is faulty.
E-E3	Exhaust fan motor stop	Cooling fan motor stop.	Turn off the power and check the fan harness. Turn on the power again. If the same error occurs again, the fan or the main PCB is faulty.
E-E5	ERROR E5	Over-run error during interfacing to main PCB CPU	This is not usually displayed.
E-E6	ERROR E6	Framing error during interfacing to main PCB CPU	

Code	Error Messages	Error	Measures
E-E7	ERROR E7	Parity error during interfacing to main PCB CPU	This is not usually displayed.
E-E8	ERROR E8	Receiving time up error during interfacing to main PCB CPU	
E-E9	ERROR E9	Send/Receive inconsistent error during interfacing to main PCB CPU	
E-EA	ERROR EA	ACK code receiving error during interfacing to main PCB CPU	
E-EB	ERROR EB	Send/Receive ID code error during interfacing to main PCB CPU	
E-EC	ERROR EC	Send data checksum error during interfacing to main PCB CPU	
E-ED	ERROR ED	Data empty error during interfacing to main PCB CPU	
E-EF	ERROR EF	Receiving error on interface	
E-F1	ERROR F1	Send time up error	
E-F2	ERROR F2	Request-to-waiting time up error	
E-F3	ERROR F3	Request-to-recvie time up error	
E-F4	ERROR F4	Receive command error	
E-F5	ERROR F5	NACK code receiving error	
E-F6	ERROR F6	Data requested for needle position can not be returned.	
E-F7	ERROR F7	It is not receive command for the request one.	
E-F8	ERROR F8	PRE code error	
E-F9	ERROR F9	No applicable command	
E-FA	ERROR FA	Interface receive data sum check error	
E-FB	ERROR FB	Send time up error	
E-FF	ERROR FF	No status is returned from main shaft CPU.	



Chapter 10 Troubleshooting

If there is any indication of trouble with the machine, check and correct as described in the table. If the trouble cannot be corrected, turn off the power and contact your distributor for corrective actions.

Mechanical Section

	Problem	Check Point
Check these points once again	<ul style="list-style-type: none"> ■ Thread breakage 	<ul style="list-style-type: none"> • Is the machine properly threaded? • Is thread tension too high? • Is the rotary hook assembly clogged? • Is there thread in the bobbin? • Is the needle bent? • Is there a rough edge or flaw on the needle plate, rotary hook, or bobbin case that might cut the thread? • Is the needle installed correctly (direction, angle, etc.) • Is the presser foot in contact with the material? • Are the thread thickness and needle size correct? • Is a thread with right-hand twist being used? (If such a thread is used, replace with a thread with left-hand twist.) • Is there any adhesive on the needle? • Is the material tension too weak? • Is there too much play between the outer rotary hook and inner rotary hook? • Does the outer rotary hook turn smoothly? • Is the clearance between the rotary hook stopper and the rotary hook adjusted correctly? • Does the thread come out from the bobbin case smoothly?
	<ul style="list-style-type: none"> ■ Needle (presser foot) interference with embroidery hoop 	<ul style="list-style-type: none"> • Is the embroidery hoop too small? • Check the size and needle start position in the sewing data.
	<ul style="list-style-type: none"> ■ Needle breakage 	<ul style="list-style-type: none"> • Is the needle attached correctly (direction, height, etc.)? • Is the needle bent? • Is the rotary hook attached correctly? • Is the timing set correctly? • Is there any backlash with the needle bar case (back/forth and right/left)? • Is the rotary hook stopper correctly attached to stop the rotary hook? • Is the needle size correct and the tip sharp? • Does the thread pass through the hole center of the presser foot?
	<ul style="list-style-type: none"> ■ Not embroidered properly 	<ul style="list-style-type: none"> • Is the material edge caught in the machine? (Are embroidery hoop and other related parts operating correctly?) • Is the material stretched properly? • Is thread tension proper? Does the lower thread come out smoothly?

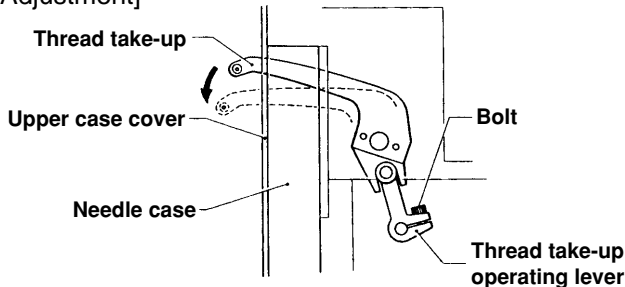

	Problem	Check Point
Check these points once again	<ul style="list-style-type: none"> Machine operation abnormal 	<ul style="list-style-type: none"> Is any set screw of the rotary encoder loosened? Is any set screw of the machine pulley loosened? Is any set screw of the machine motor pulley loosened? Is embroidery data normal? Is the XY carriage wire loosened? Is the XY carriage wire damaged? Are any set screws for the XY pulley loosened? Are any set screws for the coupling of the XY pulse motor loosened?
	<ul style="list-style-type: none"> Machine operation abnormal 	<ul style="list-style-type: none"> Is the XY carriage belt damaged? Are any set screws for the XY pulley loosened? Are any set screws for the coupling of the XY pulse motor loosened?
	<ul style="list-style-type: none"> Upper shaft locks at a certain point in one cycle 	<ul style="list-style-type: none"> Is the thread take-up stopped due to interference with the upper case cover? <p>[Adjustment]</p>  <p>Loosen the hexagon socket head cap screw of the thread take-up operating lever and adjust the take-up movable range. Tighten it securely afterwards.</p> <ul style="list-style-type: none"> Are the needle bar clamp and the top dead center stopper positioned correctly?
	<ul style="list-style-type: none"> Upper shaft pulley does not turn. 	<ul style="list-style-type: none"> Is the presser foot lifted at a retract position when the power is turned on? <p>Lower the presser foot using the lever.</p>
	<ul style="list-style-type: none"> Stitches cannot be made. 	<ul style="list-style-type: none"> Is the needle attached properly? Is the timing of the needle and rotary hook correct?

Electrical Section

Cautions

- Be sure to turn off the power of the machine and unplug the power cord before checking cable connections.
- When you check connection of the cables as instructed in this manual, also check connection and continuity between connectors.
- Carry out items described in the "Measures" section in order of appearance.
- Some checks and replacement works can be conducted only by repair people. In such cases, contact your dealer.

Symptom	Measures
The machine does not operate even if the power is turned on.	<ul style="list-style-type: none"> • Is the power cord of the machine plugged in? → Plug in the power cord. • Is the connector in the control box connected? → Connect it after checking the types and colors of the connectors. • Is fuse F1 or F5 on the power PCB in the control box blown? → Replace the fuse with a new one. If the fuse is blown again, something is faulty. Check to see if the wiring is correct. Replace the control box with a new one.
The machine does not operate even if the power is turned on. The message, "Release stop SW to operate!", is displayed on the panel.	<ul style="list-style-type: none"> • Is the stop switch (Option) turned on? → Reset the stop switch.
An overtravel error occurs.	<ul style="list-style-type: none"> • Is the frame within the cap frame area? → Move the frame within the cap frame area and turn on the power. • Check to see if the signal of the X area sensor turns ON and OFF in PORT test mode. → When the signal does not change, refer to the block diagram showing the cable connections and check to see if connection from the X cap sensor to the main PCB is proper. Replace the X cap sensor with a new one.
The needle stop position error occurs.	<ul style="list-style-type: none"> • Is the pulley manually turned and out of the stop angle? → Turn the pulley, adjust the needle at the stop position, and reset the error. • Check the signal of the stop position sensor in the encoder test mode. → Refer to the adjustment or cable connection block diagram and check connection from the needle position detention sensor to the main PCB. Replace the needle position detection sensor with a new one. • Is the main shaft brake solenoid operating? → If not, refer to the block diagram showing the cable connections and check to see if the connections from the brake solenoid to the power PCB and from connector P27 of the power PCB to connector P1 of the main PCB are proper.

Symptom	Measures
X-axis or Y-axis home position detection error occurs.	<ul style="list-style-type: none"> • Was the XY carriage moving? → If so, refer to the block diagram showing the cable connections and check to see if connection from the X and Y area sensor to the main PCB is proper. • Was the XY motor rotating? → If so, check the XY carriage mechanism. • If the XY motor is not rotating, refer to the cable connection block diagram and check to see if connection from the XY motor to the main PCB is proper.
The thread breakage error frequently occurs although thread is not broken.	<ul style="list-style-type: none"> • Enter the needle bar case test mode by pressing  and , turn the thread breakage pulley. If the needle bar number icon is displayed reversely, lower the thread breakage sensitivity value of the machine controller. (The standard value is 0.) • Check connection from the thread breakage sensor PCB to the head PCB if the needle bar number icon is not displayed reversely. • Replace the thread breakage sensor PCB with a new one.
The main shaft motor lock error occurs.	<ul style="list-style-type: none"> • Enter the encoder signal mode and manually turn the main shaft pulley. → If it is abnormally heavy, the main shaft mechanism is faulty. • Does the main shaft motor rotate at all when the error occurs? → If it does not rotate at all, check fuse F1 and F5 on the power supply PCB in the control box. Refer to the block diagram showing the cable connections and check to see if connection from the main shaft motor to the main PCB is proper. Also check connection of connectors P15 and P16 of the main PCB and connectors P1 and P2 on the power PCB in the box, and connection from connector P14 of the main PCB to the 14v terminal of the power transformer. • Manually turn the main shaft pulley in the encoder signal test mode and check to see if the stop position signal and encoder signal are proper. → If either of the signals does not change, refer to the block diagram showing the cable connections and check to see if connection from the encoder and stop position sensor to the main PCB is proper.
ERROR A8 frequently occurs.	<ul style="list-style-type: none"> • In the encoder signal test mode, manually turn the main shaft pulley and check to see that the stop position signal is correct. → If the signal does not change, refer to the cable connection block diagram and check to see if connection from the stop position sensor to the main PCB is proper.

Symptom	Measures
Main shaft rotation speed error occurs.	<ul style="list-style-type: none"> • Enter the encoder signal test mode and manually turn the main shaft pulley. → If it is abnormally heavy, the main shaft mechanism is faulty. • Refer to the block diagram showing the cable connections and check to see if connection from the main shaft motor to the main PCB is proper. Also check the connection from connectors P14 of the main PCB to the 14v terminal of the power transformer.
Exhaust fan motor stops.	<ul style="list-style-type: none"> • Refer to the block diagram showing the cable connections and check to see if connection of connector P22 of the main PCB in the control box is proper. • Check fuse F3 on the power supply PCB. → If it is blown, replace it with a new one. If it becomes blown again, the 24v system circuit is faulty.
ERROR E5 to ERROR FF frequently occur.	<ul style="list-style-type: none"> • Replace the main PCB with a new one.
All solenoids of head do not operate.	<ul style="list-style-type: none"> • Refer to the block diagram showing cable connections and check fuse F2 on the power supply PCB. → If it is blown, replace it with a new one. The 60v circuit is faulty if the fuse is blown immediately after turning on the power even after replacing the fuse.
Jump solenoid does not operate.	<ul style="list-style-type: none"> • Check to see if connection from the jump solenoid to connector P10 of the head PCB is proper. • Check the resistance value of the jump solenoid which does not operate with the connector section. The normal resistance value is approximately 185Ω. → If it is faulty, replace the solenoid with a new one. In this case, the head PCB may also be faulty. Also replace the head PCB with a new one if it does not operate properly even after replacing the solenoid. • Replace the head PCB with a new one.
Pickker solenoid does not operate.	<ul style="list-style-type: none"> • Check to see if connection from the pickker solenoid to connector P8 of the head PCB is proper. • Check the resistance value of the pickker solenoid which does not operate with the connector section. The normal resistance value is approximately 426Ω. → If it is faulty, replace the solenoid with a new one. In this case, the head PCB may also be faulty. Also replace the head PCB with a new one if it does not operate properly even after replacing the solenoid. • Replace the head PCB with a new one.

Symptom	Measures
Thread trimmer solenoid does not operate.	<ul style="list-style-type: none"> • Check to see if connection from the thread trimmer solenoid to connector P20 of the main PCB is proper. • Check the resistance value of the thread trimmer solenoid which does not operate with the connector section. The normal resistance value is approximately 27Ω. → If it is faulty, replace the solenoid with a new one. In this case, the main PCB may also be faulty. Also replace the main PCB with a new one if it does not operate properly even after replacing the solenoid. • Replace the main PCB with a new one.
Pressor foot solenoid does not operate.	<ul style="list-style-type: none"> • Check to see if connection from the pressor foot solenoid to connector P20 of the main PCB is proper. • Check the resistance value of the pressor foot solenoid which does not operate with the connector section. The normal resistance value is approximately 80Ω. → If it is faulty, replace the solenoid with a new one. In this case, the main PCB may also be faulty. Also replace the main PCB with a new one if it does not operate properly even after replacing the solenoid. • Replace the main PCB with a new one.



Connection and Installation of Optional Equipment

Attaching Bobbin Winder (Using the 9-spool cotton stand)

■ Mounting method

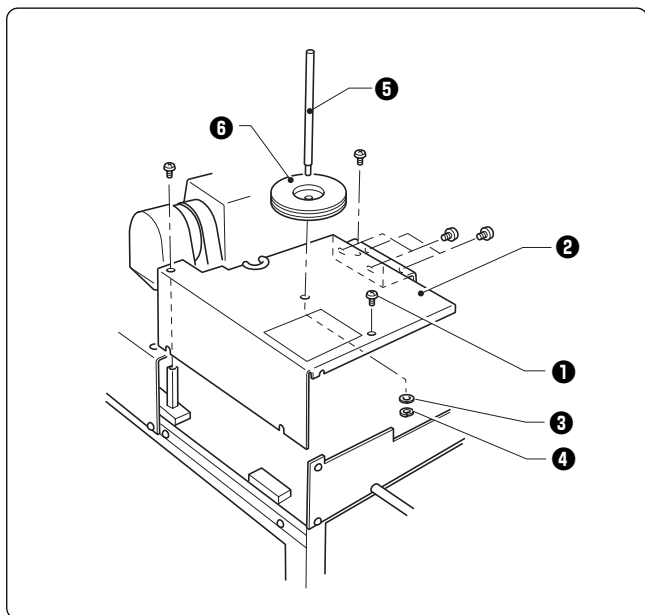

1. Loosen four screws ❶ and remove table (L) ❷.
2. Attach spool shaft ❸ to the removed table (L) ❷ with washer ❹ and nut ❺. Mount table (L) ❷ on the machine with four screws. Fit spool mat ❻ to spool shaft ❸.

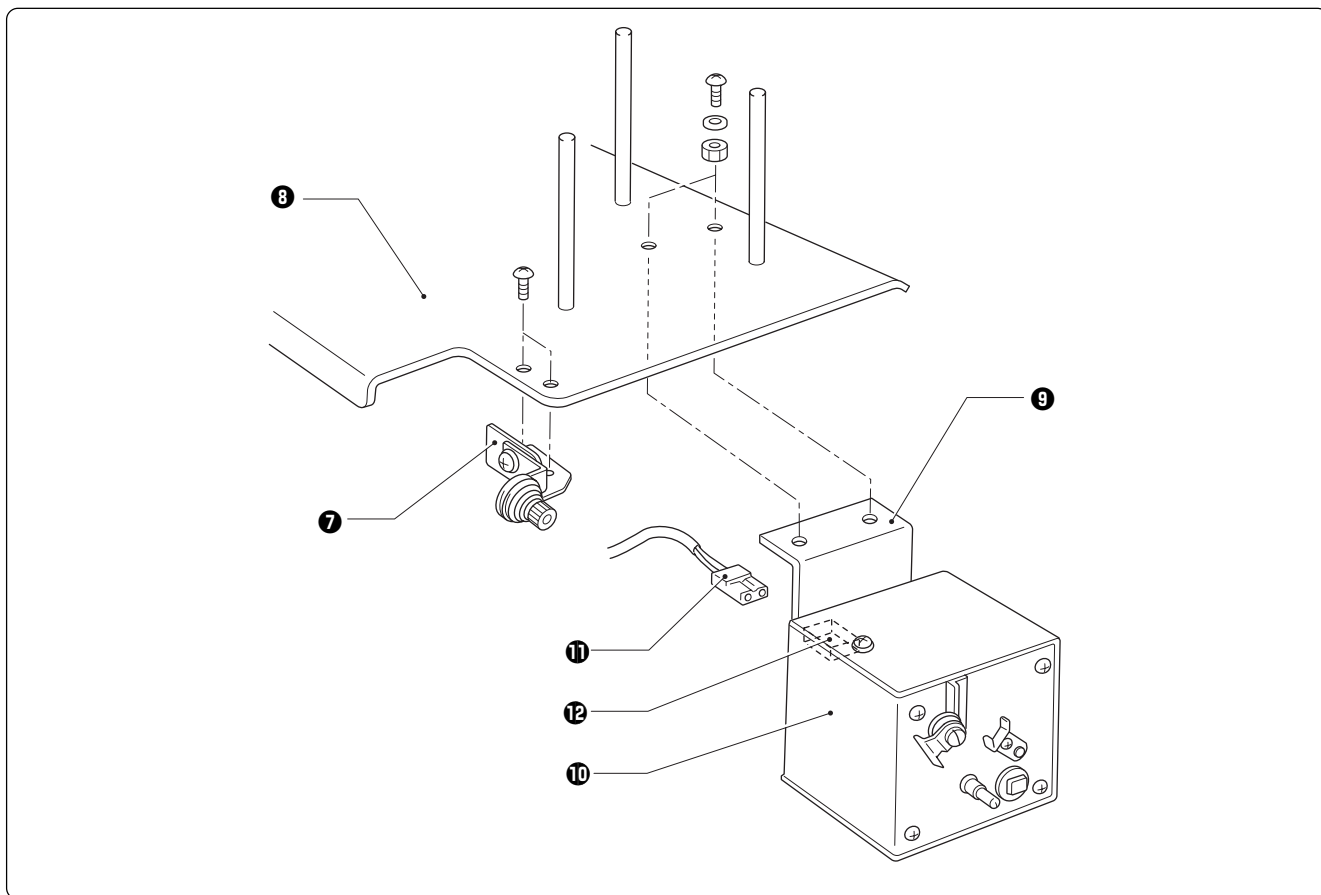

3. Attach bobbin winder guide bracket ❹ to the cotton stand ❸ with screws.
4. Attach bobbin winder assembly ❿ equipped with bobbin winder plate ❸ using two screws, washers, and nuts. Fit the connector ⓫ on the bobbin winder side to nylon connector ⓪.

■ Winding lower thread

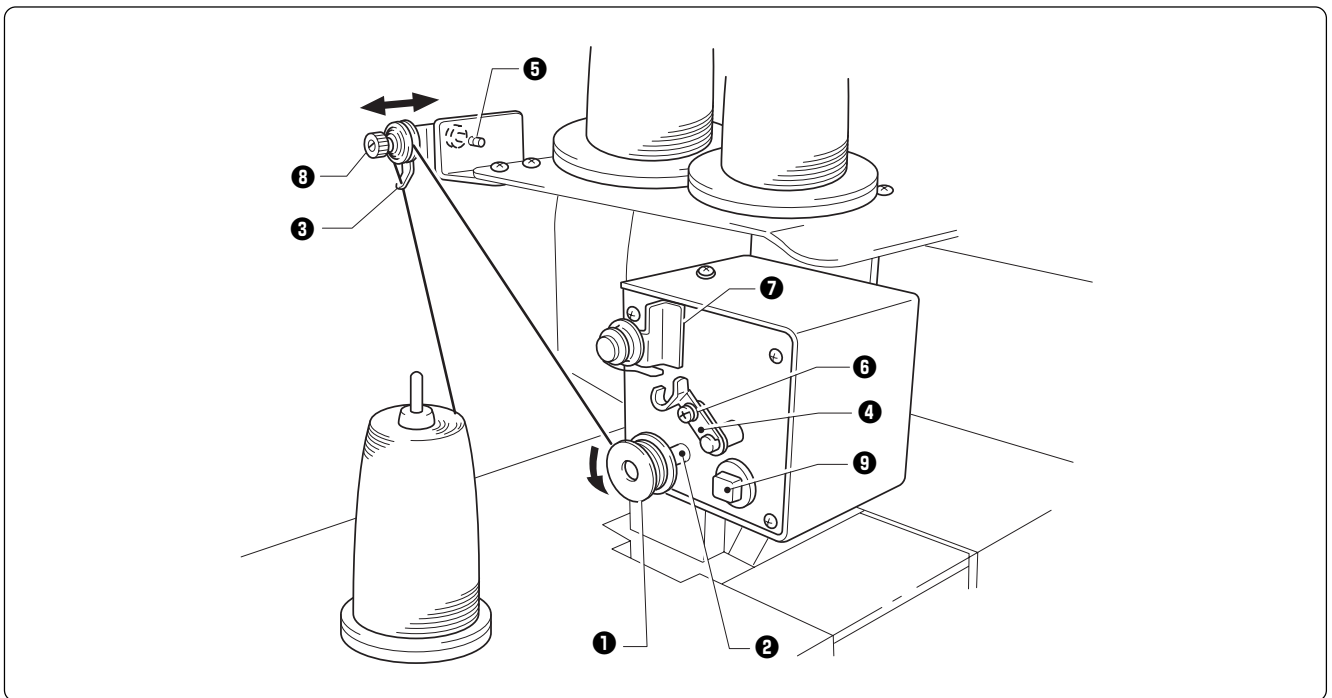

1. Turn on the power switch.
2. Fit bobbin ① to the bobbin winder shaft ②.
3. Pass a thread through thread guide ③.
4. Wind the thread around bobbin ① several times in the direction of the arrow.
5. Press bobbin hold ④.
 - Note) • If the thread cannot be wound evenly, loosen screw ⑤ and move thread guide ③ from side to side for adjustment.
 - To wind more thread around the bobbin, loosen screw ⑤ and shift bobbin hold ④.
6. After winding is finished, remove the bobbin from the bobbin winder shaft and trim the thread using tread trimmer ⑦.
 - Note) • If the thread passed though thread guide ③ comes off, loosen knob ⑧. If the thread is wound loosely, tighten knob ⑧.
 - If circuit protector ⑨ is activated, the bobbin winder motor does not rotate. Wait for a while until the motor cools and press the circuit protector. (If the motor is still hot, the pressed circuit protector will come out.)

brother[®]

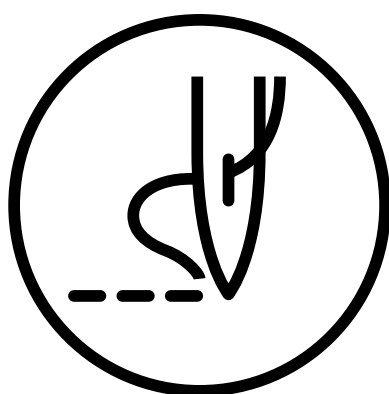

INSTRUCTION MANUAL

BROTHER INDUSTRIES,LTD. NAGOYA,JAPAN

Printed in Japan

155-116
S93116-002
2000,03,H(1)