

Brother Quick Setup Guide

For FAX-1270e, FAX-1575mc

If you cannot solve a problem, please see
Frequently Asked Questions (FAQs) on Brother World Wide Web:

URL: <http://www.brother.com>

Call Brother Customer Service at:

In USA: 1-800-284-4329

In Canada: 1-877-BROTHER

In Montreal: (514) 685-6464

THANK YOU!

CONGRATULATIONS ON PURCHASING A BROTHER MACHINE. WE ARE SURE YOU WILL BE THRILLED WITH THE CONVENIENT WAY YOUR NEW FAX PERFORMS SO MANY TASKS WITH DAZZLING RESULTS!

Follow these simple instructions in numerical order.

For more details, see your Owner's Manual.

1 Packing List

Check that you have the following items:

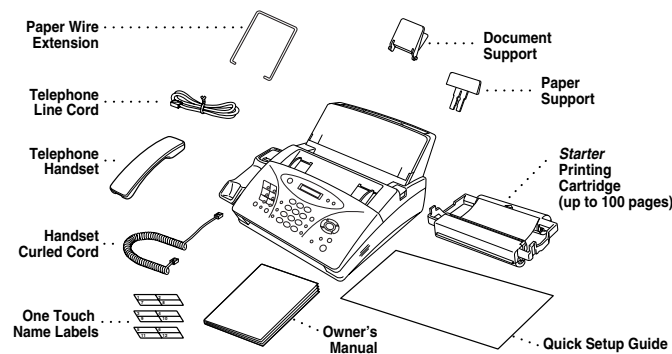

Keep the packing materials for possible future transport. If you do not pack the machine properly, it could void your warranty.

2 Attach the Document Support, Paper Wire Extension and Paper Support

A. Attach the document support.

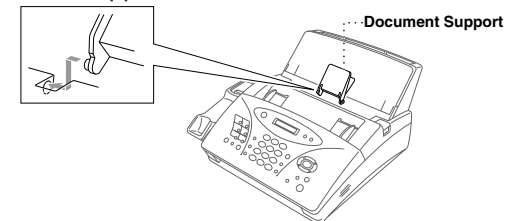

B. Attach the paper wire extension.

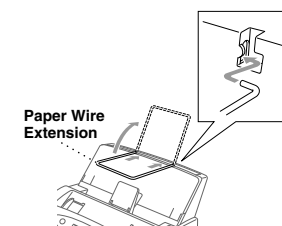

C. Attach the paper support.

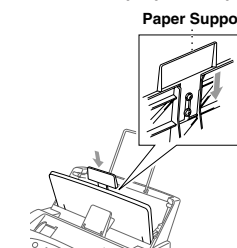

3 Load the Paper

The paper tray can hold up to 200 sheets of 20-lb paper.

- Open the paper tray cover.
- Place up to 200 sheets of paper in the paper tray. Do not allow the level of paper to pass the maximum paper line on the paper guides.
- Close the paper tray cover.

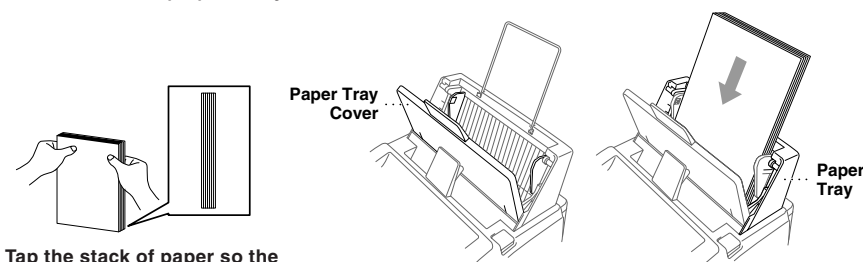

Tap the stack of paper so the edges are even.

Acceptable Paper

Size: Letter, Legal and A4
Weight: 17 lb - 24 lb
Thickness: .0031 inches - .0039 inches

4 Connect Phone Line and Power Cord

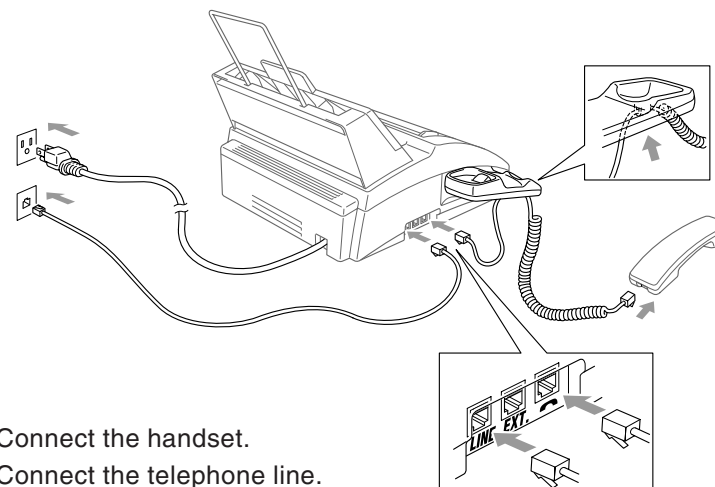

- Connect the handset.
- Connect the telephone line.
- Connect the power cord.

5 If you are sharing one phone line with an external telephone answering device, connect it now

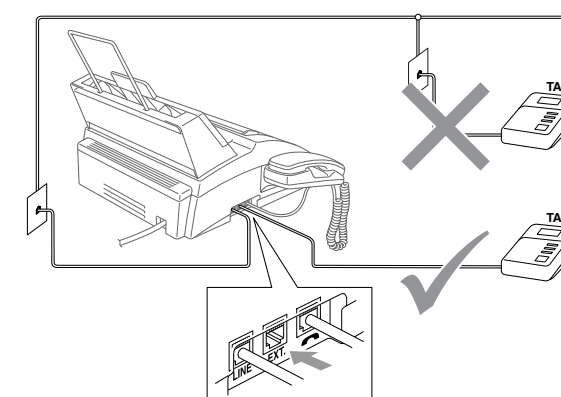

For more details, see "Connecting an External Telephone Answering Device (TAD)" in Chapter 2 of the Owner's Manual.

6 Set Date and Time

- Press **Menu/Set**, **1**, **1**.
- Enter the last two digits of the year, and then press **Menu/Set**.
- Enter two digits for the month, and then press **Menu/Set**.
- Enter two digits for the day, and then press **Menu/Set**.
- Enter the time in 24-hour format, and then press **Menu/Set**.
- Press **Stop/Exit**.

7 Set Station ID

- Press **Menu/Set**, **1**, **2**.
- Enter your fax number (up to 20 digits), and then press **Menu/Set**.
- Enter your telephone number (up to 20 digits), and then press **Menu/Set**.
- Enter your name (up to 20 characters), and then press **Menu/Set**.
- Press **Stop/Exit**.

Key	once	twice	three times	four times	five times
2	A	B	C	2	A
3	D	E	F	3	D
4	G	H	I	4	G
5	J	K	L	5	J
6	M	N	O	6	M
7	P	Q	R	7	P
8	T	U	V	8	T
9	W	X	Y	9	W

8 Select Receive Mode

Press **Receive Mode** until the correct mode for your setup is displayed.

The machine automatically answers every call as a fax.

For receiving fax and voice calls on one line.

(FAX-1270e only) An External Telephone Answering Device (TAD) answers every call and stores voice messages in its memory. Fax messages are printed. An external telephone operates as if it is in MANUAL Mode when it is connected to your Brother machine.

(FAX-1575mc) A built-in answering machine answers every call and stores voice and fax messages. For details, see chapter 9.

You control the phone line and must answer every call yourself.
For more details, see chapter 5 of the Owner's Manual.

9 For the USA only, complete the Warranty Registration and Test Sheet...

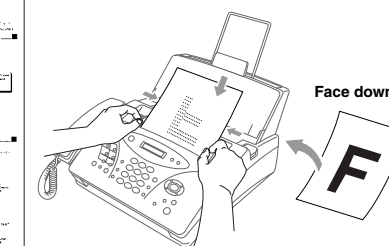
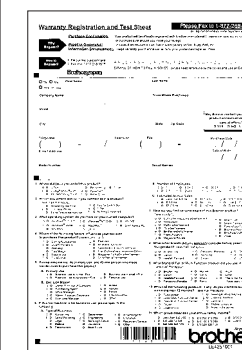

...and fax it to Brother
at 1-877-268-9575

Quick Reference Card

For complete instructions about all the features and operations of your fax machine, be sure to read your Owner's Manual.

Sending Faxes



Automatic Transmission

- 1 Place the original face down in the ADF.
- 2 Enter the fax number using the dial pad, One Touch, Speed Dial or Search.
- 3 Press **Fax Start**.

Memory Transmission

- 1 Place the original face down in the ADF.
- 2 Press **Quick-Scan/Reports**. The LCD indicates how much memory is available.
- 3 Enter the fax number.
- 4 Press **Fax Start**.

Sending a Cover Page

- 1 Place the original face down in the ADF.
- 2 Press **Menu/Set, 3, 1**.
- 3 When **NEXT FAX ONLY?** appears, press **Menu/Set**.
- 4 Press  to select **ON** (or **OFF**), and then press **Menu/Set**.
- 5 Press  to select a comment, and then press **Menu/Set**.
- 6 Enter two digits to indicate the number of pages being sent, and then press **Menu/Set**.
- 7 Press **1** to select additional settings—**OR**—Press **2** if you are ready to fax.

- 8 Enter the fax number.

- 9 Press **Fax Start**.

Receiving Faxes

Select Receive Mode

Press **Receive Mode** to select **MANUAL, FAX ONLY, FAX/TEL, TAD:ANSWER MACH. (FAX-1270e)**, or **MSG CTR (FAX-1575mc)**. If you select **FAX/TEL**, make sure you set the Ring Delay and F/T Ring Time.

Turning ON Message Center Mode (FAX-1575mc Only) See Chapter 9 of the Owner's Manual.

- 1 Turn Message Storage **ON**.
- 2 Record the Outgoing Message (**MSG CTR OGM**).
- 3 Press  until it lights.

Manual Reception

- 1 Pick up the handset.
- 2 Press **Fax Start** if you hear fax tones (beeps).
- 3 When the LCD shows **RECEIVE**, replace the handset.

Easy Receive

- 1 Press **Menu/Set, 2, 3**.
- 2 Press  to select **ON, OFF** or **SEMI**.
- 3 Press **Menu/Set**.
- 4 Press **Stop/Exit**.

Setup Auto Dial Numbers

Storing One-Touch Dial Numbers

- 1 Press **Menu/Set, 6, 1**.
- 2 Press the One Touch key where you want to store the number.
- 3 Enter a number (up to 20 digits), and then press **Menu/Set**.
- 4 Enter a name (up to 15 characters), and then press **Menu/Set**.
- 5 Press  to select **FAX, TEL, FAX/TEL** or **CHAIN**, and then press **Menu/Set**.
- 6 Press **Stop/Exit**.

Storing Speed Dial Numbers



- 1 Press **Menu/Set, 6, 2**.
- 2 Enter a two-digit speed dial number, and then press **Menu/Set**.
- 3 Enter a number (up to 20 digits), and then press **Menu/Set**.
- 4 Enter a name (up to 15 characters), and then press **Menu/Set**.
- 5 Press  to select **FAX, TEL, FAX/TEL** or **CHAIN**, and then press **Menu/Set**.
- 6 Press **Stop/Exit**.

Dialing Options

One-Touch Dialing / Speed Dialing

- 1 Pick up the handset—**OR**—Press **Hook (FAX-1270e)** or **Speaker Phone (FAX-1575mc)**.
- 2 When you hear a dial tone, press the One Touch key of the location you want to call—**OR**—Press **Search/Speed Dial**, press **#**, and then press the two-digit Speed Dial number.
 - If you pressed **Hook (FAX-1270e)** to dial, pick up the handset when the other party answers.
- 3 To hang up, replace the handset—**OR**—Press **Speaker Phone (FAX-1575mc)**.



Searching the Auto Dial Numbers

- 1 Press **Search/Speed Dial**, and then enter the first letter of the name you're looking for.
- 2 Press  or  to search the memory.

- 3 When the name is displayed, lift the handset for a voice call.
 - OR**—Press **Speaker phone (FAX-1575mc)**.
- 4 Press **Fax Start** to begin dialing.

Message Center (FAX-1575mc Only)

Recording OGM

- 1 Press **Menu/Set, 8, 3**.
- 2 Press  to reach **MSG CTR OGM?**, and then press **Menu/Set**.
- 3 Press  to select **RECORD OGM?**, and then press **Menu/Set**.
- 4 Pick up the handset to record a message.
- 5 Replace the handset.

Playing a Voice Message

- 1 Press **Play/Record**.
- 2 Use *** (RWD)** to repeat a message. Use **# (FWD)** to skip a message.
- 3 Press **Stop/Exit**.

Printing a Fax Message

- 1 Press **Play/Record**.
- 2 After voice messages have played, press **1**.

Erasing Messages

To erase voice messages individually

- 1 Press **Play/Record**.
- 2 Press **Erase** after the two short beeps or while the message is playing.
- 3 Press **1**.
- 4 Press **Stop/Exit**.

To erase messages all at once

- 1 Press **Erase**.
- 2 Press  to select **VOICE, FAX, or MSG**, and then press **Menu/Set**.
- 3 Press **1**.
- 4 Press **Stop/Exit**.

Brother fax-back system:
In USA only: 1-800-521-2846

Brother Global Web Site:
<http://www.brother.com>

Frequently Asked Questions (FAQs) and Product Support:
<http://solutions.brother.com>

Brother Accessories and Supplies:
In USA: 1-888-879-3232 (voice)

1-800-947-1445 (fax)
<http://www.brothermall.com>

In Canada: 1-877-BROTHER (voice)