

# S-7250A

## SAFETY INSTRUCTIONS

Thank you very much for buying a BROTHER sewing machine.

**Before using your new machine, please read the safety instructions and the explanations given in the instruction manual. Please keep this manual within easy reach for quick reference.**

With industrial sewing machines, it is normal to carry out work while positioned directly in front of moving parts such as the needle and thread take-up, and consequently there is always a danger of injury that can be caused by these parts. Follow the instructions from training personnel and instructors regarding safe and correct operation before operating the machine so that you will know how to use it correctly.

**Use the URL or QR code below to view the instruction manual.**

Americas  
URL: <http://www.brother-usa.com/Support/>



Europe, Middle East and Africa  
URL: <http://www.brother-industrial.com/>



Asia  
URL: [http://www.brother.com/as\\_oc/ism/](http://www.brother.com/as_oc/ism/)







SB7926001  
使用说明书







### [1] Safety indications and their meanings

This instruction manual and the indications and symbols that are used on the machine itself are provided in order to ensure safe operation of this machine and to prevent accidents and injury to yourself or other people. The meanings of these indications and symbols are given below.

#### Indications

	<b>DANGER</b>	The instructions which follow this term indicate situations where failure to follow the instructions will result in death or serious injury.
	<b>WARNING</b>	The instructions which follow this term indicate situations where failure to follow the instructions could result in death or serious injury.
	<b>CAUTION</b>	The instructions which follow this term indicate situations where failure to follow the instructions may result in minor or moderate injury.

#### Symbols

-  . . . . . This symbol (  ) indicates something that you should be careful of. The picture inside the triangle indicates the nature of the caution that must be taken. (For example, the symbol at left means "beware of injury".)
-  . . . . . This symbol (  ) indicates something that you must not do.
-  . . . . . This symbol (  ) indicates something that you must do. The picture inside the circle indicates the nature of the thing that must be done. (For example, the symbol at left means "you must make the ground connection".)

### [2] Notes on safety

** DANGER**

 Wait at least 5 minutes after turning off the power switch and disconnecting the power cord from the wall outlet before opening the cover of the control box. Touching areas where high voltages are present can result in severe injury.







** WARNING**

 Do not allow any liquids to get onto this sewing machine, otherwise fire, electric shocks or operating problems may occur.











 If any liquid gets inside the sewing machine (machine head or control box), immediately turn off the power and disconnect the power plug from the electrical outlet, and then contact the place of purchase or a qualified technician.

** CAUTION**



**Environmental requirements**

 Use the sewing machine in an area which is free from sources of strong electrical noise such as electrical line noise or static electric noise. Sources of strong electrical noise may cause problems with correct operation.	 The ambient temperature should be within the range of 5°C to 35°C during use. Temperatures which are lower or higher than this may cause problems with correct operation.
 Any fluctuations in the power supply voltage should be within ±10% of the rated voltage for the machine. Voltage fluctuations which are greater than this may cause problems with correct operation.	 The relative humidity should be within the range of 45% to 85% during use, and no dew formation should occur in any devices. Excessively dry or humid environments and dew formation may cause problems with correct operation.
 The power supply capacity should be greater than the requirements for the sewing machine's power consumption. Insufficient power supply capacity may cause problems with correct operation.	 In the event of an electrical storm, turn off the power and disconnect the power cord from the wall outlet. Lightning may cause problems with correct operation.
	 Do not connect anything to the USB port other than the USB memory. If this is not observed, problems with operation may result.

**Installation**











 Machine installation should only be carried out by a qualified technician.	 If using a work table which has casters, the casters should be secured in such a way so that they cannot move.
 Contact your Brother dealer or a qualified electrician for any electrical work that may need to be done.	 Secure the table so that it will not move when tilting back the machine head. If the table moves, it may crush your feet or cause other injuries.
 The sewing machine weighs approximately 35 kg (77lb). The installation should be carried out by two or more people.	 Use both hands to hold the machine head when tilting it back or returning it to its original position. If only one hand is used, the weight of the machine head may cause your hand to slip, and your hand may get caught.
 Do not connect the power cord until installation is complete. The machine may operate if the treadle is depressed by mistake, which could result in injury.	 Be sure to wear protective goggles and gloves when handling the lubricating oil and grease, so that they do not get into your eyes or onto your skin, otherwise inflammation can result. Furthermore, do not drink the oil or eat the grease under any circumstances, as they can cause vomiting and diarrhea. Keep the oil out of the reach of children.
 Turn off the power switch before inserting or removing the plug, otherwise damage to the control box could result.	
 Be sure to connect the ground. If the ground connection is not secure, you run a high risk of receiving a serious electric shock, and problems with correct operation may also occur.	
 When securing the cords, do not bend the cords excessively or fasten them too hard with staples, otherwise there is the danger that fire or electric shocks could occur.	

**Lubrication**





-  Turn off the power switch before carrying out work. The machine may operate if the treadle is depressed by mistake, which could result in injury.
-  Be sure to wear protective goggles and gloves when handling the lubricating oil, so that it does not get into your eyes or onto your skin. If care is not taken, inflammation can result. Furthermore, do not drink the lubricating oil. Diarrhea or vomiting may result. Keep the oil out of the reach of children.
-  When cutting the nozzle of the oil tank, hold the base of the nozzle securely. If you hold the end of the nozzle, injury from the scissors may result.

** CAUTION**











**Sewing**

 This sewing machine should only be used by operators who have received the necessary training in safe use beforehand.	 Do not touch any of the moving parts or press any objects against the machine while sewing, as this may result in personal injury or damage to the machine.
 The sewing machine should not be used for any applications other than sewing.	 Secure the table so that it will not move when tilting back the machine head. If the table moves, it may crush your feet or cause other injuries.
 Be sure to wear protective goggles when using the machine. If goggles are not worn, there is the danger that if a needle breaks, parts of the broken needle may enter your eyes and injury may result.	 Use both hands to hold the machine head when tilting it back or returning it to its original position. If only one hand is used, the weight of the machine head may cause your hand to slip, and your hand may get caught.
 Turn off the power switch at the following times. The machine may operate if the treadle is depressed by mistake, which could result in injury. <ul style="list-style-type: none"> <li>• When threading the needle</li> <li>• When replacing the bobbin and needle</li> <li>• When not using the machine and when leaving the machine unattended</li> </ul>	 If an error occurs in machine operation, or if abnormal noises or smells are noticed, immediately turn off the power switch. Then contact your nearest Brother dealer or a qualified technician.
 If using a work table which has casters, the casters should be secured in such a way so that they cannot move.	 If the machine develops a problem, contact your nearest Brother dealer or a qualified technician.
 Attach all safety devices before using the sewing machine. If the machine is used without these devices attached, injury may result.	

**Cleaning**

 Turn off the power switch before carrying out cleaning. The machine may operate if the treadle is depressed by mistake, which could result in injury.	 Be sure to wear protective goggles and gloves when handling the lubricating oil and grease, so that they do not get into your eyes or onto your skin, otherwise inflammation can result. Furthermore, do not drink the oil or eat the grease under any circumstances, as they can cause vomiting and diarrhea. Keep the oil out of the reach of children.
 Secure the table so that it will not move when tilting back the machine head. If the table moves, it may crush your feet or cause other injuries.	
 Use both hands to hold the machine head when tilting it back or returning it to its original position. If only one hand is used, the weight of the machine head may cause your hand to slip, and your hand may get caught.	

**Maintenance and inspection**

 Maintenance and inspection of the sewing machine should only be carried out by a qualified technician.	 Secure the table so that it will not move when tilting back the machine head. If the table moves, it may crush your feet or cause other injuries.
 Ask your Brother dealer or a qualified electrician to carry out any maintenance and inspection of the electrical system.	 Use both hands to hold the machine head when tilting it back or returning it to its original position. If only one hand is used, the weight of the machine head may cause your hand to slip, and your hand may get caught.
 Turn off the power switch and disconnect the power cord from the wall outlet at the following times, otherwise the machine may operate if the treadle is depressed by mistake, which could result in injury. <ul style="list-style-type: none"> <li>• When carrying out inspection, adjustment and maintenance</li> <li>• When replacing consumable parts such as the rotary hook and knife</li> </ul>	 When replacing parts and installing optional accessories, be sure to use only genuine Brother parts. Brother will not be held responsible for any accidents or problems resulting from the use of non-genuine parts.
 Always be sure to turn off the power switch and then wait one minute before opening the motor cover. If you touch the surface of the motor, it may cause burns.	 If any safety devices have been removed, be absolutely sure to re-install them to their original positions and check that they operate correctly before using the machine.
 If the power switch needs to be left on when carrying out some adjustment, make sure that you switch the sewing machine to maintenance mode. Pay careful attention to safety.	 To prevent accidents and problems, do not modify the machine yourself. Brother will not be held responsible for any accidents or problems resulting from modifications made to the machine.

### About the machine set-up location

- Do not set up this sewing machine near other equipment such as televisions, radios or cordless telephones, otherwise such equipment may be affected by electronic interference from the sewing machine.
- The sewing machine should be plugged directly into an AC wall outlet. Operation problems may result if extension cords are used.

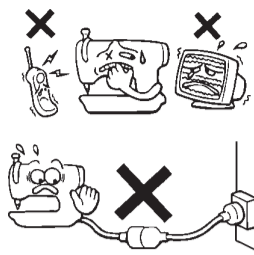

0475D

### Carrying the machine

- The sewing machine should be carried by the arm and the motor cover by two people as shown in the illustration.
- Do not hold by any part other than the motor cover. If this is not observed, it may result in damage to the sewing machine.

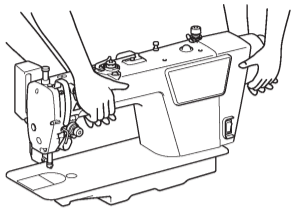

1341D

### Tilting back the machine head

- Hold section (A) with your foot so that the table does not move, and then push the arm with both hands to tilt back the machine head.

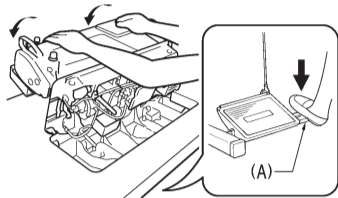

1342D

### Returning the machine head to the upright position

- Clear away any tools, etc. which may be near the table holes.
- While holding the face plate with your left hand, gently return the machine head to the upright position with your right hand.

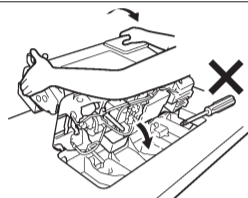

1343D

5

### [3] Warning labels

The following warning labels appear on the sewing machine. Please follow the instructions on the labels at all times when using the machine. If the labels have been removed or are difficult to read, please contact your nearest Brother dealer.

危険 高電圧部分にふれて、大けがをすることがある。 電源を切り、5分たってからカバーを開けず。		危険 接触高電圧部分、会致致受傷。 在切断電源5分钟后、再开启蓋蓋。	
DANGER Hazardous voltage will cause injury. Turn off main switch and wait 5 minutes before opening this cover.	GEFAHR Hochspannung verletzungsgefahr! Bitte schalten sie den hauptschalter aus und warten sie 5 minuten bevor sie diese abdeckung öffnen.	DANGER Un voltage non adapte provoque des blessures. Eteindre l'interrupteur et attendre 5 minutes avant d'ouvrir le capot.	PERIGRO Un voltaje inadecuado puede provocar las heridas. Apagar el interruptor principal y esperar 5 minutos antes de abrir esta cubierta.

- Touching areas where high voltages are present can result in severe injury. Turn off the power before opening the cover.
  - CAUTION  
 Moving parts may cause injury.  
 Operate with safety devices\* installed.  
 Turn off the power before carrying out operations such as threading, changing the needle, bobbin, knives or hook, cleaning and adjusting.
  - Be careful not to get your hands caught when returning the machine head to its original position after it has been tilted.
  - Be careful to avoid injury from the moving thread take-up.
  - High temperature warning display
  - Be sure to connect the ground. If the ground connection is not secure, you run a high risk of receiving a serious electric shock, and problems with correct operation may also occur.
  - Direction of operation
  - Do not hold. Problems with operation or injury may occur.
  - Do not place your hands inside the bottom cover. Problems with operation or injury may occur.
- \* Safety devices: (A) Finger guard (B) Thread take-up cover (C) Motor cover (D) Pulse motor cover
- brother**  
Lubricating Oil for Machining

**CAUTION**  
Lubricating oil may cause inflammation to eye and skin.  
Wear protective glasses and gloves.  
Swallowing oil can cause diarrhoea and vomiting.  
Do not swallow.

Keep away from children.  
**FIRST AID**  
Eye contact :  
-Rinse with plenty of cold water.  
-Seek medical help.  
Skin contact :  
-Wash with soap and water.  
If swallowed :  
-Seek medical help immediately.  
-Do not induce vomiting.

6

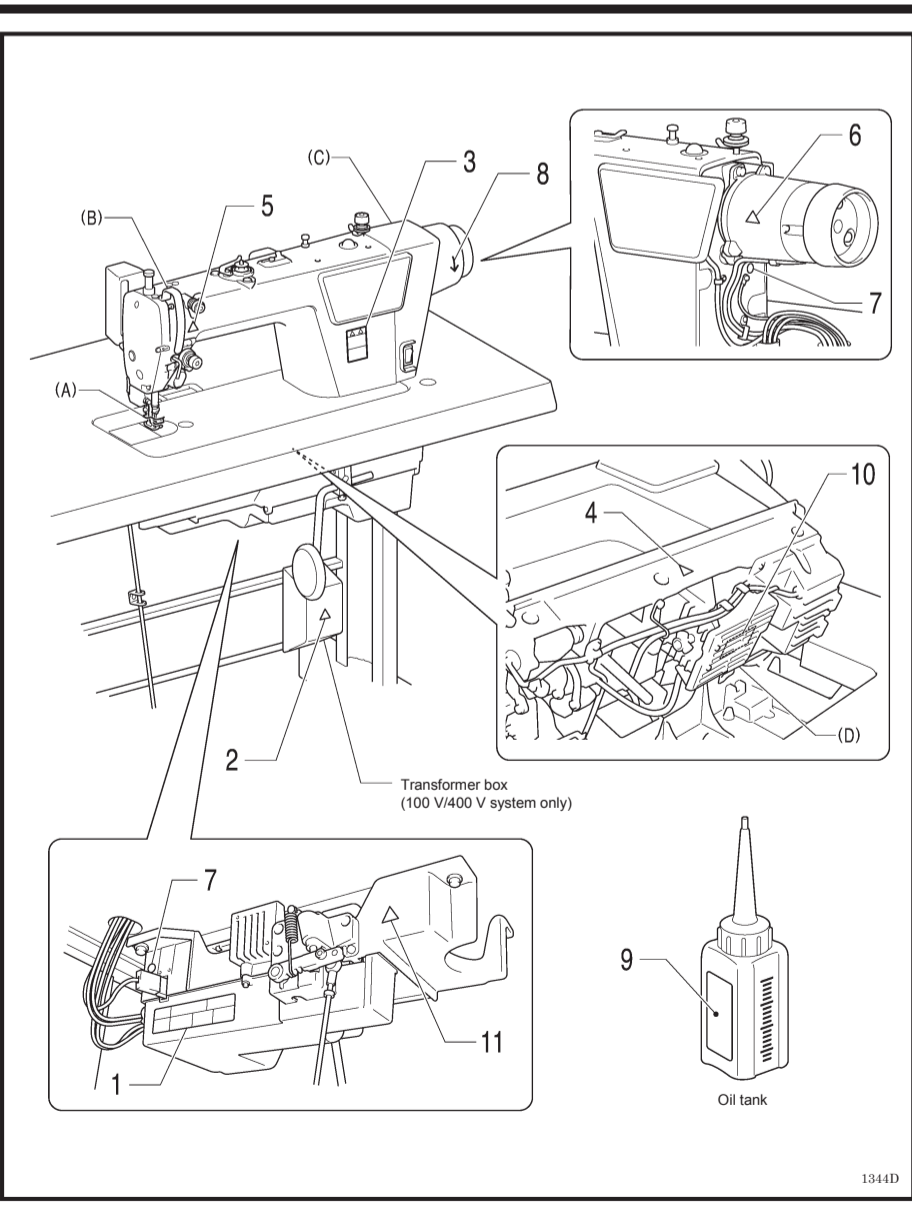

1344D

\* Please note that the contents of this manual may differ slightly from the actual product purchased as a result of product improvements.

7