

Operation Manual

Embroidery Machine

Product Code: 888-G90

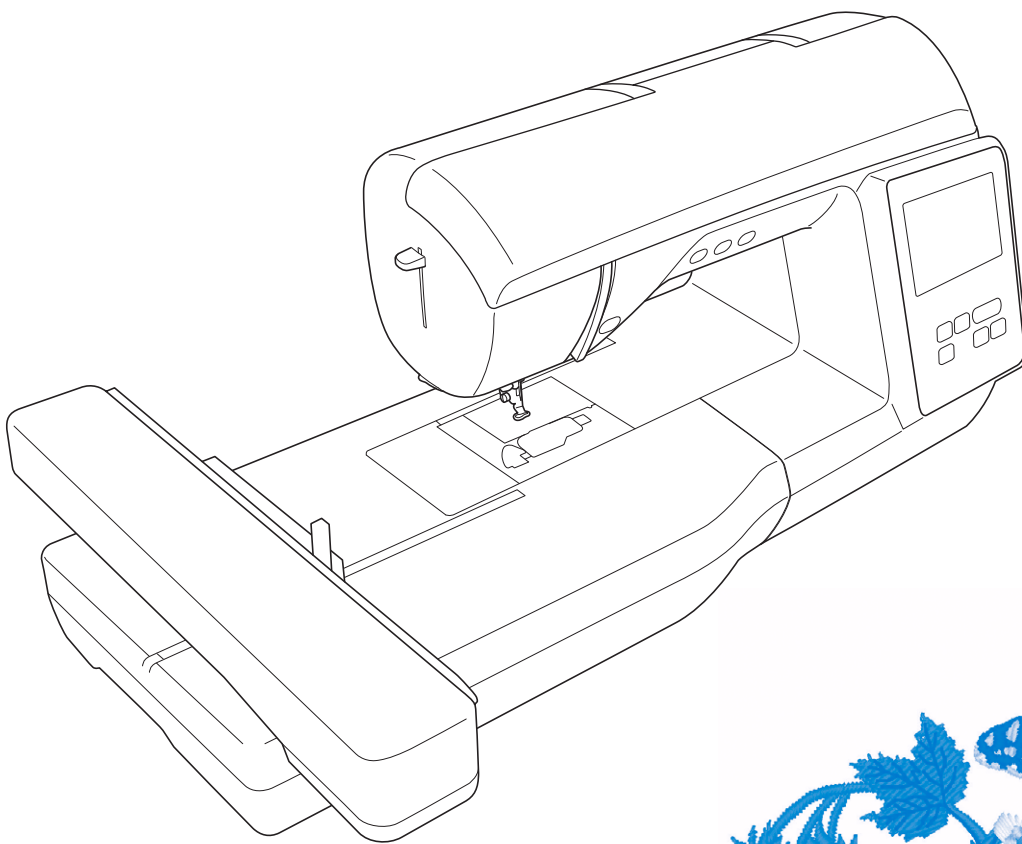

Be sure to read this document before using the machine.
We recommend that you keep this document nearby for future reference.

INTRODUCTION

Thank you for purchasing this machine. Before using this machine, carefully read the “IMPORTANT SAFETY INSTRUCTIONS”, and then study this manual for the correct operation of the various functions. In addition, after you have finished reading this manual, store it where it can quickly be accessed for future reference.

IMPORTANT SAFETY INSTRUCTIONS

Please read these safety instructions before attempting to use the machine.

DANGER - To reduce the risk of electrical shock

- 1** Always unplug the machine from the electrical outlet immediately after using, when cleaning, making any user servicing adjustments mentioned in this manual, or if you are leaving the machine unattended.

WARNING - To reduce the risk of burns, fire, electrical shock, or injury to persons.

- 2** Always unplug the machine from the electrical outlet when making any adjustments mentioned in the instruction manual.

- To unplug the machine, switch the machine to the symbol “O” position to turn it off, then grasp the plug and pull it out of the electrical outlet. Do not pull on the cord.
- Plug the machine directly into the electrical outlet. Do not use an extension cord.
- Always unplug your machine if there is a power failure.

- 3** Electrical Hazards:

- This machine should be connected to an AC power source within the range indicated on the rating label. Do not connect it to a DC power source or converter. If you are not sure what kind of power source you have, contact a qualified electrician.
- This machine is approved for use in the country of purchase only.

- 4** Never operate this machine if it has a damaged cord or plug, if it is not working properly, has been dropped or damaged, or water is spilled on the unit. Return the machine to the nearest authorized Brother dealer for examination, repair, electrical or mechanical adjustment.

- While the machine is stored or in use if you notice anything unusual, such as an odor, heat, discoloration or deformation, stop using the machine immediately and unplug the power cord.
- When transporting the machine, be sure to carry it by its handle. Lifting the machine by any other part may damage the machine or result in the machine falling, which could cause injuries.
- When lifting the machine, be careful not to make any sudden or careless movements, which may cause a personal injury.

5 Always keep your work area clear:

- Never operate the machine with any air openings blocked. Keep ventilation openings of the machine and foot control free from the build up of lint, dust, and loose cloth.
- Do not use extension cords. Plug the machine directly into the electrical outlet.
- Never drop or insert foreign objects in any opening.
- Do not operate where aerosol (spray) products are being used or where oxygen is being administered.
- Do not use the machine near a heat source, such as a stove or iron; otherwise, the machine, power cord or garment being sewn may ignite, resulting in fire or an electric shock.
- Do not place this machine on an unstable surface, such as an unsteady or slanted table, otherwise the machine may fall, resulting in injuries.

6 Special care is required when embroidering:

- Always pay close attention to the needle. Do not use bent or damaged needles.
- Keep fingers away from all moving parts. Special care is required around the machine needle.
- Switch the machine to the symbol "O" position to turn it off when making any adjustments in the needle area.
- Do not use a damaged or incorrect needle plate, as it could cause the needle to break.

7 This machine is not a toy:

- Your close attention is necessary when the machine is used by or near children.
- The plastic bag that this machine was supplied in should be kept out of the reach of children or disposed of. Never allow children to play with the bag due to the danger of suffocation.
- Do not use outdoors.

8 For a longer service life:

- When storing this machine, avoid direct sunlight and high humidity locations. Do not use or store the machine near a space heater, iron, halogen lamp, or other hot objects.
- Use only neutral soaps or detergents to clean the case. Benzene, thinner, and scouring powders can damage the case and machine, and should never be used.
- Always consult the Operation Manual when replacing or installing needle or other parts to assure correct installation.

9 For repair or adjustment:

- If the light unit is damaged, it must be replaced by an authorized Brother dealer.
- In the event a malfunction occurs or adjustment is required, first follow the troubleshooting table in the back of the Operation Manual to inspect and adjust the machine yourself. If the problem persists, please consult your local authorized Brother dealer.

Use this machine only for its intended use as described in the manual.

Use accessories recommended by the manufacturer as contained in this manual.

The contents of this manual and specifications of this product are subject to change without notice.

For additional product information and updates, visit our website at www.brother.com

SAVE THESE INSTRUCTIONS

This machine is intended for household use.

FOR USERS IN COUNTRIES EXCEPT CENELEC COUNTRIES

This appliance is not intended for use by persons (including children) with reduced physical, sensory or mental capabilities, or lack of experience and knowledge, unless they have been given supervision or instruction concerning use of the appliance by a person responsible for their safety. Children should be supervised to ensure that they do not play with the appliance.

FOR USERS IN CENELEC COUNTRIES

This appliance can be used by children aged from 8 years and above and persons with reduced physical, sensory or mental capabilities or lack of experience and knowledge if they have been given supervision or instruction concerning use of the appliance in a safe way and understand the hazards involved. Children shall not play with the appliance. Cleaning and user maintenance shall not be made by children without supervision.

FOR USERS IN THE UK, EIRE, MALTA AND CYPRUS ONLY

IMPORTANT

- In the event of replacing the plug fuse, use a fuse approved by ASTA to BS 1362, i.e. carrying the  mark, rating as marked on plug.
- Always replace the fuse cover. Never use plugs with the fuse cover omitted.
- If the available electrical outlet is not suitable for the plug supplied with this equipment, you should contact your authorized Brother dealer to obtain the correct lead.

TRADEMARKS

IMPORTANT:

READ BEFORE DOWNLOADING, COPYING, INSTALLING OR USING.

By downloading, copying, installing or using the software you agree to this license. If you do not agree to this license, do not download, install, copy or use the software.

Intel License Agreement For Open Source Computer Vision Library

Copyright © 2000, Intel Corporation, all rights reserved. Third party copyrights are property of their respective owners.

Redistribution and use in source and binary forms, with or without modification, are permitted provided that the following conditions are met:

- Redistribution's of source code must retain the above copyright notice, this list of conditions and the following disclaimer.
- Redistribution's in binary form must reproduce the above copyright notice, this list of conditions and the following disclaimer in the documentation and/or other materials provided with the distribution.
- The name of Intel Corporation may not be used to endorse or promote products derived from this software without specific prior written permission.

This software is provided by the copyright holders and contributors "as is" and any express or implied warranties, including, but not limited to, the implied warranties of merchantability and fitness for a particular purpose are disclaimed. In no event shall Intel or contributors be liable for any direct, indirect, incidental, special, exemplary, or consequential damages (including, but not limited to, procurement of substitute goods or services; loss of use, data, or profits; or business interruption) however caused and on any theory of liability, whether in contract, strict liability, or tort (including negligence or otherwise) arising in any way out of the use of this software, even if advised of the possibility of such damage.

All information provided related to future Intel products and plans is preliminary and subject to change at any time, without notice.

WHAT YOU CAN DO WITH THIS MACHINE

B Basic operations

After purchasing your machine, be sure to read this section first. This section provides details on the initial setup procedures as well as descriptions of this machine's more useful functions.

Chapter 1 GETTING READY

Page B-2

To learn the operation of the principal parts and the screens

Chapter 2 STARTING TO EMBROIDER

Page B-25

To learn how to prepare for embroidering and basic embroidering operations

E Embroidering

This section provides instruction on editing embroidery patterns and recalling stored embroidery patterns.

Chapter 1 EMBROIDERY

Page E-2

Embroider artistically; by editing the built-in patterns you can easily create your own original designs.

A Appendix

This section provides important information for operating this machine.

Chapter 1 MAINTENANCE AND TROUBLESHOOTING

Page A-2

The various maintenance and troubleshooting procedures are described.

CONTENTS

INTRODUCTION	i
IMPORTANT SAFETY INSTRUCTIONS	i
TRADEMARKS	iv
WHAT YOU CAN DO WITH THIS MACHINE	v

B Basic operations

Chapter 1 GETTING READY 2

Names of Machine Parts and Their Functions.....	2
Machine.....	2
Needle and presser foot section	3
Embroidery Unit.....	3
Operation buttons	4
Operation panel and operation keys.....	4
Included accessories	5
Optional accessories	6
Turning the Machine On/Off.....	7
Turning on the machine	8
Turning off the machine	8
Select machine setting for the first time	8
LCD Operation	9
Viewing the LCD.....	9
Using the settings key.....	10
Adjusting input sensitivity for operation keys.....	12
Saving a settings screen image to USB flash drive.....	13
Checking machine operating procedures.....	13
Winding/Installing the Bobbin.....	14
Winding the bobbin	14
Installing the bobbin.....	17
Upper Threading	19
Threading the upper thread	19
Threading the needle.....	21
Threading the needle manually (without using the needle threader).....	22
Replacing the Needle.....	23
Checking the needle.....	23
Replacing the needle.....	23

Chapter 2 STARTING TO EMBROIDER 25

Embroidery Step by Step.....	25
Attaching the Embroidery Unit.....	26
Embroidery Attractive Finishes	28
Preparing the Fabric	29
Attaching iron-on stabilizers (backing) to the fabric	29
Hooping the fabric in the embroidery frame.....	30
Embroidering small fabrics or fabric edges	32
Attaching the Embroidery Frame	33
Selecting Embroidery Patterns.....	34
Copyright information	34
Embroidery pattern types	34
Selecting an embroidery pattern	34
Confirming the Pattern Position	35
Checking the pattern position.....	35
Previewing the selected pattern	35
Embroidering.....	36
Embroidering a pattern	36
Changing the thread color display	37

E Embroidering

Chapter 1 EMBROIDERY 2

Selecting Patterns.....	2
Selecting embroidery patterns/Brother "Exclusives"/floral alphabet patterns	2
Selecting character patterns	2
Selecting frame patterns.....	4
Editing Patterns	5
Moving the pattern	6
Changing the size of the pattern.....	6
Rotating the pattern	6
Changing the thread color	7
Creating a horizontal mirror image	7
Changing the density (alphabet character and frame patterns only).....	7
Deleting the pattern	7
Displaying patterns in the screen magnification	8
After editing	8
Editing Character Patterns	9
Changing the colors of alphabet character patterns.....	9
Switching between text written vertically and horizontally	9
Changing the font of entered characters.....	10
Changing character spacing.....	10
Reducing character spacing	10
Separating combined character patterns	10
Editing single characters	11
Changing the configuration of character patterns	12
Combining Patterns.....	13
Editing combined patterns	13
Embroidering combined patterns	14
Editing All Patterns.....	15
Moving the pattern	15
Rotating the pattern	15
Aligning the pattern and the needle	15
Embroidering linked characters.....	16
Embroidery Applications.....	18
Sewing embroidery patterns which use appliqué	18
Using a frame pattern to make an appliqué (1).....	20
Using a frame pattern to make an appliqué (2).....	21
Sewing split embroidery patterns	22
Adjustments During the Embroidery Process	23
If the bobbin runs out of thread.....	23
If the thread breaks during sewing	24
Restarting from the beginning	24
Resuming embroidery after turning off the power	24
Making Embroidery Adjustments	26
Adjusting thread tension	26
Adjusting the bobbin case (with no color on the screw)	27
Using the automatic thread cutting function (END COLOR TRIM).....	28
Using the Thread Trimming Function (JUMP STITCH TRIM)	28
Adjusting the embroidery speed.....	28
Changing the "Embroidery Frame Display"	29
Selecting/displaying patterns according to the embroidery frame size	30
Changing the background colors of the embroidery patterns.....	30
Specifying the size of pattern thumbnails	31
Using the Memory Function.....	32
Embroidery data precautions	32
Saving embroidery patterns in the machine's memory	33
Saving embroidery patterns to USB flash drive.....	34
Retrieving patterns from the machine's memory	34
Recalling from USB flash drive	35

A Appendix

Chapter 1 MAINTENANCE AND TROUBLESHOOTING	2
Care and Maintenance	2
Restrictions on oiling	2
Precautions on storing the machine	2
Cleaning the LCD Screen	2
Cleaning the machine surface	2
Cleaning the race	2
About the maintenance message	4
Touch panel is malfunctioning	4
Operation beep	4
Replacing the embroidery foot	5
Troubleshooting	6
List of symptoms	6
Error messages	10
Specifications	12
Upgrading your machine's software using USB flash drive	13
Index	14

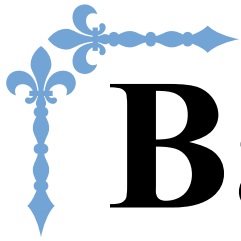

Basic operations

This section provides details on the initial setup procedures as well as descriptions of this machine's more useful functions.

Page number starts with "B" in this section.

Chapter1 GETTING READY..... B-2

Chapter2 STARTING TO EMBROIDER..... B-25

Chapter 1 GETTING READY

Names of Machine Parts and Their Functions

The names of the various parts of the machine and their functions are described below. Before using the machine, carefully read these descriptions to learn the names of the machine and their locations.

Machine

■ Front view

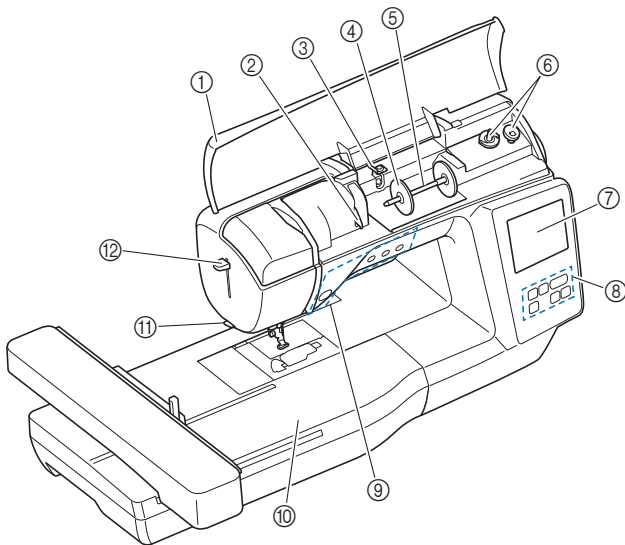

- ① **Top cover**
Open the top cover to place the spool of thread on the spool pin.
- ② **Thread guide plate**
Pass the thread around the thread guide plate when threading the upper thread.
- ③ **Bobbin winding thread guide and pretension disk**
Pass the thread under this thread guide and around the pretension disk when winding the bobbin thread.
- ④ **Spool cap**
Use the spool cap to hold the spool of thread in place.
- ⑤ **Spool pin**
Place a spool of thread on the spool pin.
- ⑥ **Bobbin winder**
Use the bobbin winder when winding the bobbin.
- ⑦ **LCD (liquid crystal display)**
Settings for the selected pattern and error messages appear in the LCD. (page B-9)
- ⑧ **Operation panel**
From the operation panel, embroidery patterns can be selected and edited, and operations for using the machine can be selected (page B-4).
- ⑨ **Operation buttons**
Use these buttons to operate the machine. (page B-4)
- ⑩ **Embroidery unit**
Attach embroidery unit to embroider. (page B-26)
- ⑪ **Thread cutter**
Pass the threads through the thread cutter to cut them.
- ⑫ **Needle threader lever**
Use the needle threader lever to thread the needle.

■ Right-side/rear view

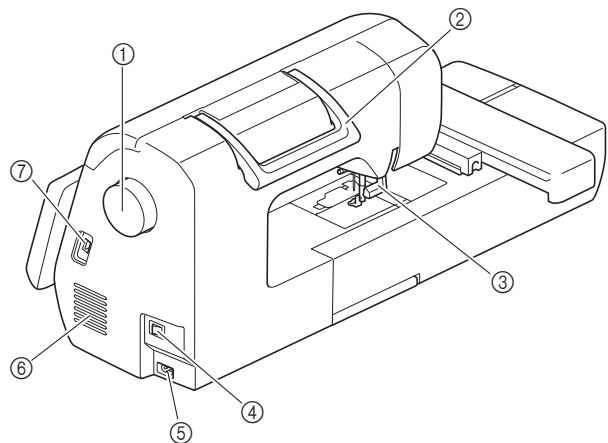

- ① **Handwheel**
Turn the handwheel toward you (counterclockwise) to raise and lower the needle.
- ② **Handle**
Carry the machine by its handle when transporting.
- ③ **Presser foot lever**
Raise and lower the presser foot lever to raise and lower the presser foot.
- ④ **Main power switch**
Use the main power switch to turn the machine on and off.
- ⑤ **Power supply jack**
Insert the plug on the power cord into the power supply jack.
- ⑥ **Air vent**
The air vent allows the air surrounding the motor to circulate. Do not cover the air vent while the machine is being used.
- ⑦ **USB port (for a USB flash drive)**
In order to import patterns from a USB flash drive, insert the USB flash drive directly into the USB port.

Needle and presser foot section

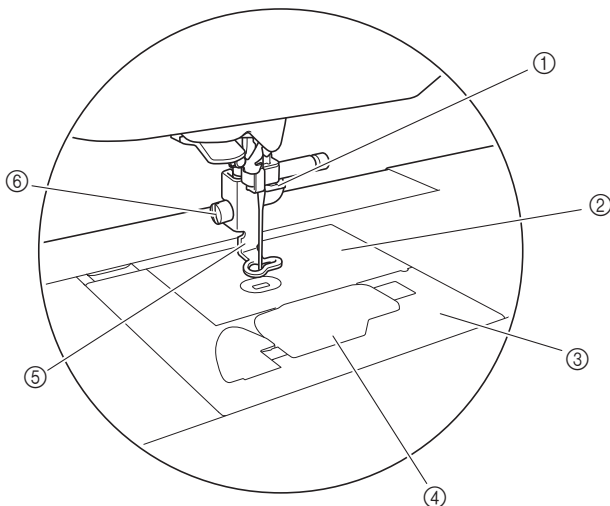

- ① **Needle bar thread guide**
Pass the upper thread through the needle bar thread guide.
- ② **Needle plate**
- ③ **Needle plate cover**
Remove the needle plate cover to clean the bobbin case and race.
- ④ **Bobbin cover/bobbin case**
Remove the bobbin cover and then insert the bobbin into the bobbin case.
- ⑤ **Embroidery foot**
The embroidery foot helps control fabric flexibility for better stitch consistency.
- ⑥ **Embroidery foot screw**
Use the embroidery foot screw to hold the embroidery foot in place.

Embroidery Unit

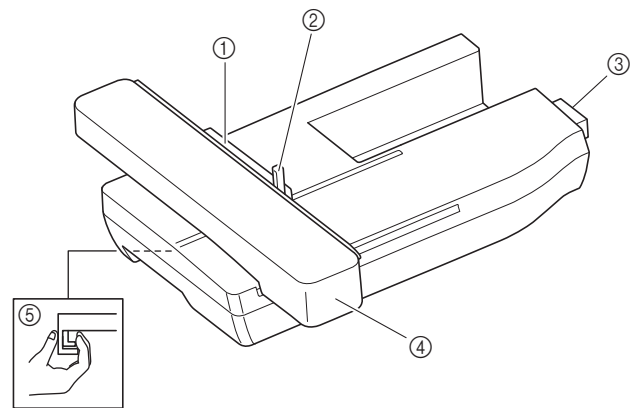



- ① **Embroidery frame holder**
Insert the embroidery frame into the embroidery frame holder to hold the frame in place. (page B-33)
- ② **Frame-securing lever**
Press the frame-securing lever down to secure the embroidery frame. (page B-33)
- ③ **Embroidery unit connection**
Insert the embroidery unit connection into the connection port when attaching the embroidery unit. (page B-26)
- ④ **Carriage**
The carriage moves the embroidery frame automatically when embroidering. (page B-26)
- ⑤ **Release button (located under the embroidery unit)**
Press the release button to remove the embroidery unit. (page B-27)

CAUTION

- Before inserting or removing the embroidery unit, turn the main power to OFF.
- After the embroidery frame is set in the frame holder, be sure the frame-securing lever is correctly lowered.

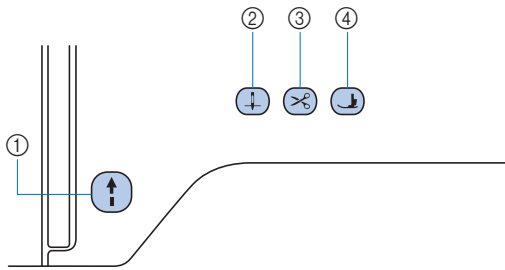
Operation buttons



- ① **“Start/Stop” button** 

Press the “Start/Stop” button to start or stop embroidering. The button changes color according to the machine’s operation mode.

 - Green: The machine is ready to embroider or is embroidering.
 - Red: The machine can not embroider.
 - Orange: The machine is winding the bobbin thread, or the bobbin winder shaft is moved to the right side.
- ② **Needle position button** 

Press the needle position button to raise or lower the needle.
- ③ **Thread cutter button** 

Press the thread cutter button after embroidering is stopped to cut both the upper and the bobbin threads.
- ④ **Presser foot lifter button** 

Press this button to lower the presser foot and apply pressure to the fabric. Press this button again to raise the presser foot.

CAUTION

- Do not press  (Thread cutter button) after the threads have already been cut, otherwise the needle may break, the threads may become tangled or damage to the machine may occur.

Operation panel and operation keys

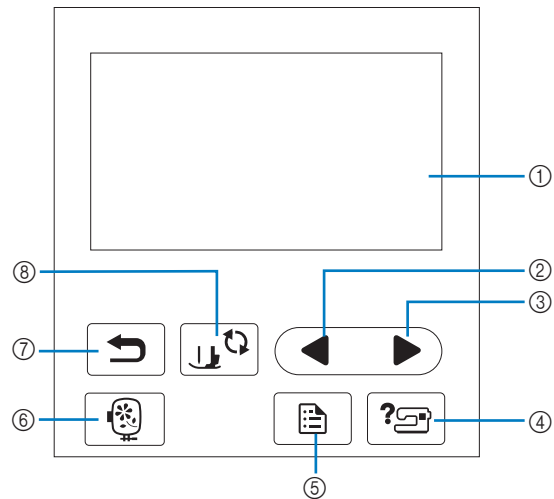



- ① **LCD (liquid crystal display) (touch panel)**

Selected pattern settings and messages are displayed. Touch the keys displayed on the LCD to perform operations. For details, refer to “LCD Operation” on page B-9.
- ② **Previous page key** 

Displays the previous screen when there are items that are not displayed on the LCD.
- ③ **Next page key** 

Displays the next screen when there are items that are not displayed on the LCD.
- ④ **Help key** 

Press to get help on using the machine.
- ⑤ **Settings key** 

Press to set the needle stop position, the buzzer sound, and more.
- ⑥ **Embroidery key** 

Press this key to sew embroidery.
- ⑦ **Back key** 

Press to return to the previous screen.
- ⑧ **Presser foot/Needle exchange key** 











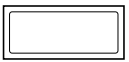



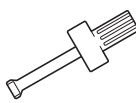

Press this key before changing the needle, the presser foot, etc. This key locks all key and button functions to prevent operation of the machine.

Note

- The operation keys of this machine are capacitive touch sensors. Operate the keys by directly touching them with your finger. The response of the keys varies according to the user. The pressure exerted on the keys does not affect the response of the keys.
- Since the operation keys react differently depending on the user, adjust the setting for “Adjusting input sensitivity for operation keys” on page B-12.
- When using an electrostatic touch pen, make sure that its point is 8 mm or more. Do not use a touch pen with a thin point or a unique shape.

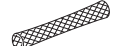
Included accessories

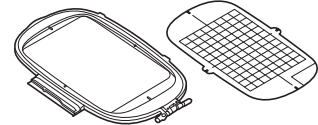
Included accessories may differ from the table below depending on the machine model you purchased. For more details on included accessories and their part codes of your machine, refer to the Quick Reference Guide.

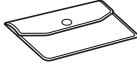
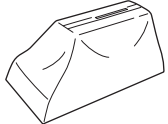
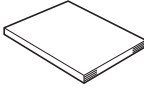
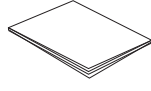
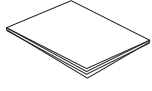
1.  Embroidery foot "U"	2.  Needle set 75/11 3 needles 90/14 1 needle	3.  Bobbin (4) One is on machine.	4.  Seam ripper	5.  Scissors	6.  Cleaning brush
7.  Screwdriver (large)	8.  Screwdriver (small)	9.  L-shaped screwdriver	10.  Disc-shaped screwdriver	11.  Spool cap (large)	12.  Spool cap (medium) On machine
13.  Spool cap (small)	14.  Thread spool insert (mini king thread spool)	15.  Spool net	16.  Bobbin case (no color on the screw) (on machine)	17.  Embroidery frame set (extra large) 26 cm (H) × 16 cm (W) (10-1/4 inches (H) × 6-1/4 inches (W))	
18.  Poly 90 weight bobbin thread	19.  Accessory bag	20.  Dust cover	21.  Operation Manual	22.  Quick Reference Guide	23.  Embroidery Design Guide

Optional accessories

The following are available as optional accessories to be purchased separately. For more optional accessories and their part codes, refer to the Quick Reference Guide.

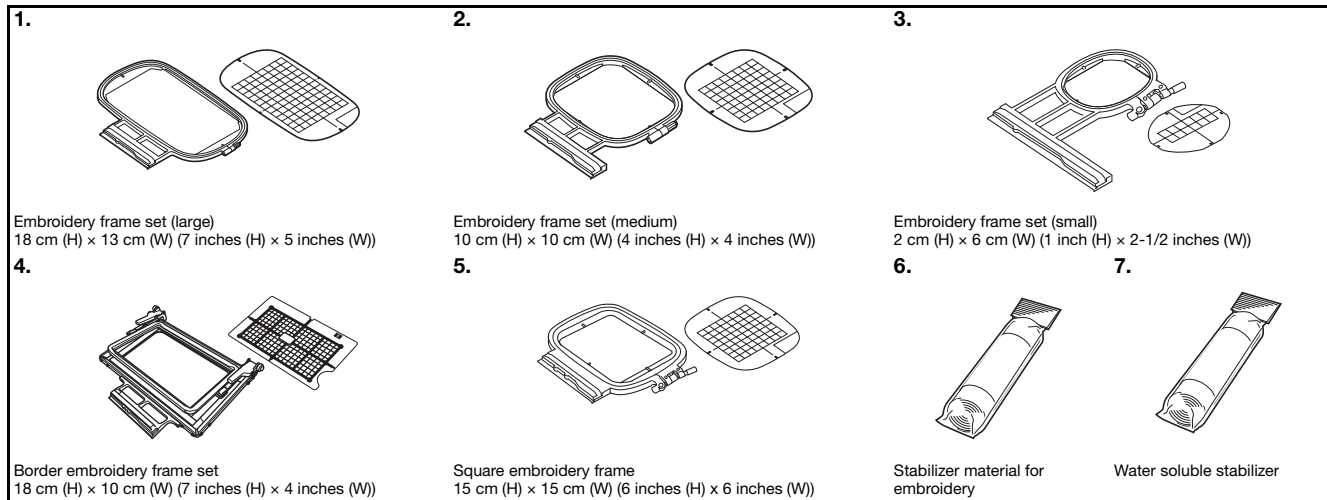

Memo

- To obtain optional accessories or parts, contact your authorized Brother dealer.
- All specifications are correct at the time of printing. Please be aware that some specifications may change without notice.
- Visit your nearest authorized Brother dealer for a complete listing of optional accessories available for your machine.
- Always use accessories recommended for this machine.

Turning the Machine On/Off

WARNING

- Use only regular household electricity for the power source. Using other power sources may result in fire, electric shock, or damage to the machine.
- Make sure that the plugs on the power cord are firmly inserted into the electrical outlet and the power cord receptacle on the machine. Otherwise, a fire or electric shock may result.
- Do not insert the plug on the power cord into an electrical outlet that is in poor condition.
- Turn the main power to OFF and remove the plug in the following circumstances:
 - When you are away from the machine
 - After using the machine
 - When the power fails during use
 - When the machine does not operate correctly due to a bad connection or a disconnection
 - During electrical storms

CAUTION

- Use only the power cord included with this machine.
- Do not use extension cords or multi-plug adapters with any other appliances plugged into them. Fire or electric shock may result.
- Do not touch the plug with wet hands. Electric shock may result.
- When unplugging the machine, always turn the main power to OFF first. Always grasp the plug to remove it from the electrical outlet. Pulling on the cord may damage the cord, or lead to fire or electric shock.
- Do not allow the power cord to be cut, damaged, modified, forcefully bent, pulled, twisted, or bundled. Do not place heavy objects on the cord. Do not subject the cord to heat. These things may damage the cord, or cause fire or electric shock. If the cord or plug is damaged, take the machine to your authorized Brother dealer for repairs before continuing use.
- Unplug the power cord if the machine is not to be used for a long period of time. Otherwise, a fire may result.
- When leaving the machine unattended, either the main switch of the machine should be turned to OFF or the plug must be removed from the electrical outlet.
- When servicing the machine or when removing covers, the machine must be unplugged.
- For USA only

This appliance has a polarized plug (one blade wider than the other). To reduce the risk of electrical shock, this plug is intended to fit in a polarized electrical outlet only one way. If the plug does not fit fully in the electrical outlet, reverse the plug. If it still does not fit, contact a qualified electrician to install the proper electrical outlet. Do not modify the plug in any way.

Turning on the machine

- 1 Make sure that the machine is turned off (the main power switch is set to "O"), and then plug the power cord into the power supply jack on the right side of the machine.
- 2 Insert the plug of the power cord into a household electrical outlet.

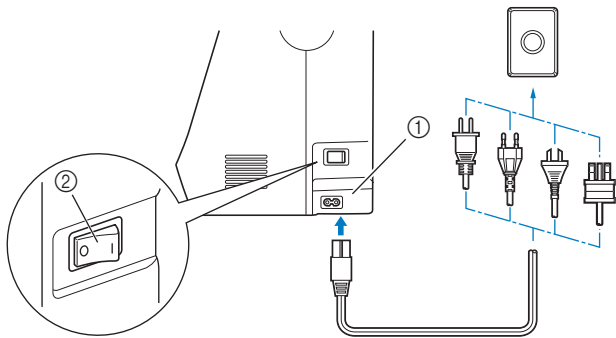

- ① Power supply jack
- ② Main power switch

- 3 Press the right side of the main power switch on the right side of the machine to turn the machine on (set it to "I").

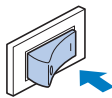

→ The light, LCD and the "Start/Stop" button light up when the machine is turned on.



Memo

- When the machine is turned on, the machine will make a sound when it moves; this is not a malfunction.
- If the machine is turned off in the middle of embroidering, the operation will resume after turning the power on again.

- 4 When the machine is turned on, the opening movie is played. Press anywhere on the screen.

Turning off the machine

When you are finished using the machine, turn it off. In addition, before transporting the machine to another location, be sure to turn it off.

- 1 Make sure that the machine is not embroidering.
- 2 Press the main power switch on the right side of the machine in the direction of the "O" symbol to turn the machine off.

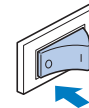

Select machine setting for the first time

When you first turn on the machine, select the language of your choice. Follow the procedure below when the settings screen appears automatically.

- 1 Press ◀ and ▶ to select your choice of language.

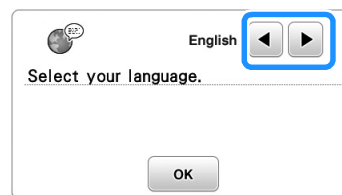

- 2 Press .

LCD Operation

Viewing the LCD

An opening movie may be displayed when the power is turned on. When the opening movie is displayed, the screen will be displayed if you touch the LCD with your finger. Press a key with your finger to select the embroidery pattern, to select a machine function, or to select an operation indicated on the key.

The screen below appears after the embroidery carriage moves to its initial position.

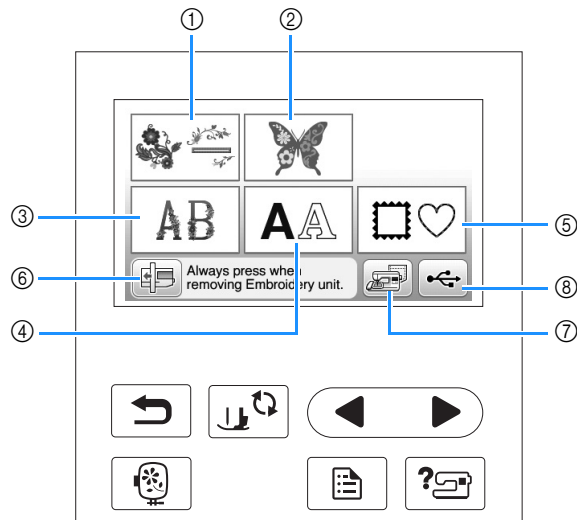

- ① Embroidery patterns
- ② Brother "Exclusives"
- ③ Floral alphabet patterns
- ④ Character patterns
- ⑤ Frame patterns
- ⑥ Press this key to position the embroidery unit for storage
- ⑦ Patterns saved in the machine's memory
- ⑧ Patterns saved in USB flash drive

Using the settings key

Press  to change the default machine settings (needle stop position, embroidery speed, opening display, etc.). Press , after you changed necessary settings.

■ Embroidery settings

Page 1

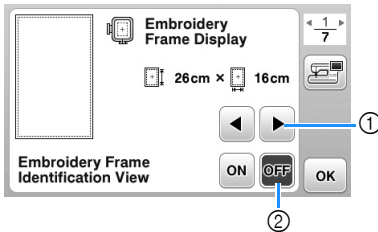

Page 2

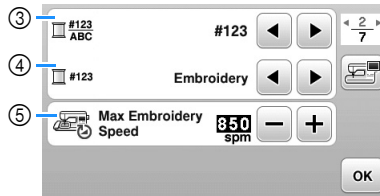

Page 3

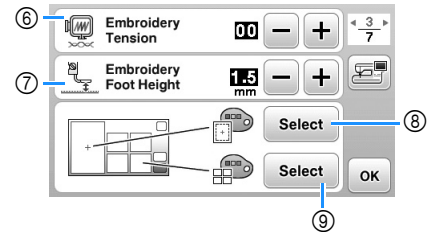

- ① Select the embroidery frame to be used and displayed as a guide. For details, refer to “Changing the “Embroidery Frame Display”” in the “Embroidering” section.
- ② When set to “ON”, the embroidery pattern can be selected according to the embroidery frame size that you have selected in number ①. For details, refer to “Selecting/displaying patterns according to the embroidery frame size” in the “Embroidering” section.
- ③ Change the thread color display on the “Embroidery” screen; thread number, color name. (page B-37).
- ④ When the thread number “#123” is selected, select from six thread brands. (page B-37).
- ⑤ Adjust the maximum embroidery speed setting. For details, refer to “Adjusting the embroidery speed” in the “Embroidering” section.
- ⑥ Adjust the upper thread tension for embroidering. For details, refer to “Adjusting thread tension” in the “Embroidering” section.
- ⑦ Select the height of the embroidery foot during embroidering. (page B-29).
- ⑧ Change the color of the background for the embroidery display area. For details, refer to “Changing the background colors of the embroidery patterns” in the “Embroidering” section.
- ⑨ Change the color of the background for the thumbnail area. For details, refer to “Changing the background colors of the embroidery patterns” in the “Embroidering” section.

Page 4

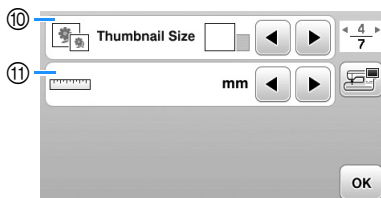

- ⑩ Press to specify the size of pattern thumbnails. For details, refer to “Specifying the size of pattern thumbnails” in the “Embroidering” section.
- ⑪ Change the display units (mm/inch).

■ General settings

Page 5

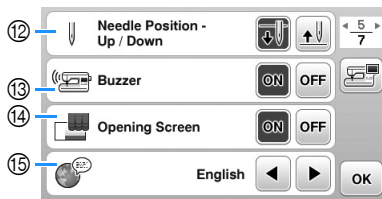

Page 6

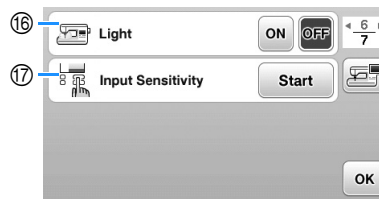

Page 7

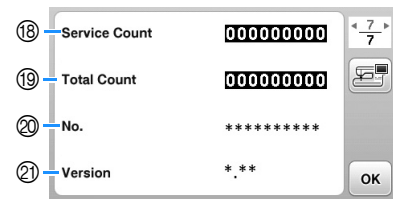



- 12 Select the needle stop position (the needle position for when the machine is not being operated) to be up or down.
- 13 Select whether to hear the beep operation sound. For details, refer to “Operation beep” in the “Appendix” section.
- 14 Select whether to display the opening screen when the machine is turned on.
- 15 Select the display language. (page B-12)
- 16 Select whether to turn on the light for the needle area and work area.
- 17 Select the level of the input sensitivity for operation keys. (page B-12)
- 18 Display the service count which is a reminder to take your machine in for regular servicing. (Contact your authorized Brother dealer for details.)
- 19 Display the total number of stitches sewn on this machine.
- 20 The “No.” is the internal machine number for your machine.
- 21 Display the program version of the LCD panel.



Memo

- The latest version of software is installed in your machine. Check with your local authorized Brother dealer or at “<http://support.brother.com/>” for available updates. For details, refer to “Upgrading your machine’s software using USB flash drive” in the “Appendix” section.
- Press to save the current settings screen image to USB flash drive. (page B-13)

■ Choosing the display language

- 1 Press .
- 2 Display page 5.
- 3 Use  and  to choose the display language.

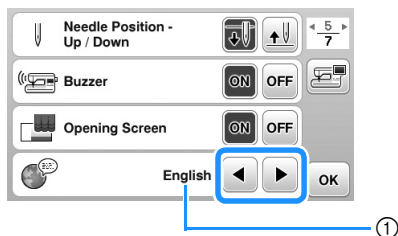

① Display language



- 4 Press  to return to the original screen.

Adjusting input sensitivity for operation keys

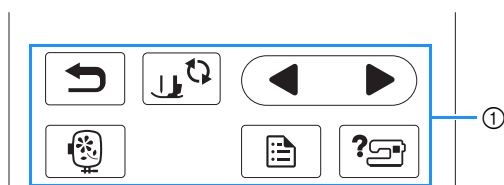
You can adjust the sensitivity of the operation keys to five levels. Display the settings screen to set desired level.



① Operation keys

- 1 Press .
- 2 Display page 6 by pressing .
- 3 Press "Start".

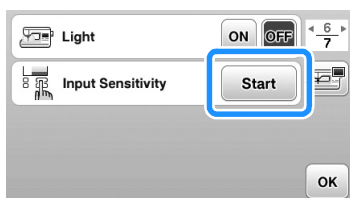

→ The adjusting screen is displayed.

- 4 Adjust the "Input Sensitivity" by pressing .

- The higher the setting, the more sensitive the keys will be. The default setting is "3".

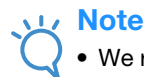

Note

- We recommend selecting the highest setting if an electrostatic touch pen is being used.

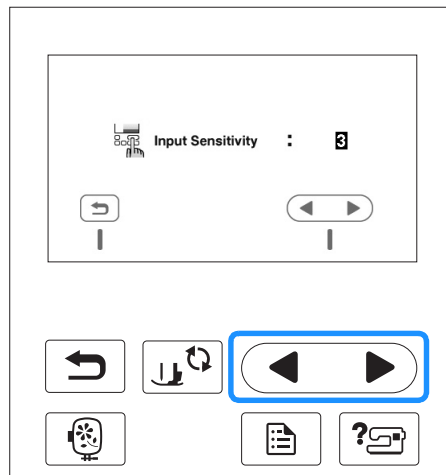

- 5 Press  to return to previous screen.

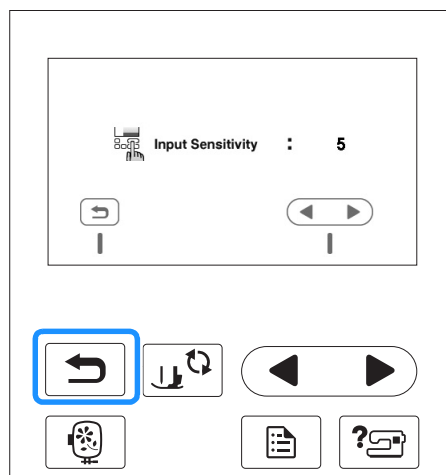

■ If the machine does not respond when an operation key is pressed

Hold down  (Thread cutter button) and turn on the machine to reset the setting. Display the settings screen, and then adjust the setting again.

Saving a settings screen image to USB flash drive

An image of the settings screen can be saved as a BMP file.

- 1 Insert the USB flash drive into the USB port on the right side of the machine.

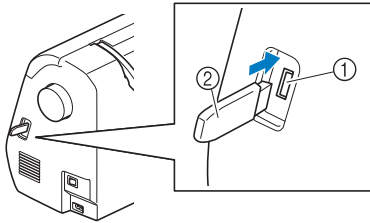

- ① USB port
- ② USB flash drive

- 2 Press .
 - The settings screen appears. Select the settings screen page, make the changes that you want, and then save the screen image.

- 3 Press .
 - The image file will be saved to the USB flash drive.

- 4 Remove the USB flash drive, and then for future reference, check the saved image using a computer.
 - The files for settings screen images are saved with the name "S#####.bmp" in a folder labeled "bPocket".

Checking machine operating procedures

- 1 Turn on the machine.
 - The LCD comes on.
- 2 Press anywhere on the LCD screen.
- 3 Press on the operation panel.

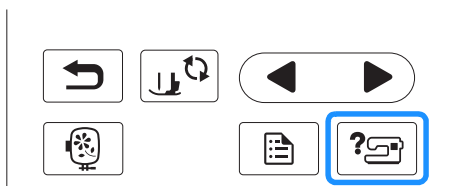

→ The machine help screen appears.

- 4 Press the item to be displayed.

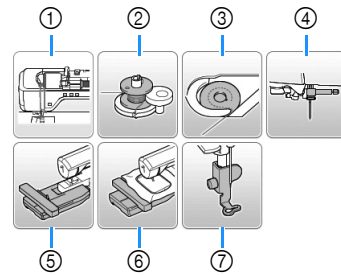

- ① Upper threading
- ② Bobbin winding
- ③ Bobbin installation
- ④ Needle replacement
- ⑤ Embroidery unit attachment
- ⑥ Embroidery frame attachment
- ⑦ Embroidery foot attachment

→ The first screen describing the procedure for the selected topic appears.

- Pressing , returns you to the item selection screen.

- 5 Press to switch to the next page.

If you press , you return to the previous page.

- 6 After you have finished viewing, press two times.

Winding/Installing the Bobbin

⚠ CAUTION

- Only use the Bobbin (part code: SA156, SFB: XA5539-151) designed specifically for this machine. Use of any other bobbin may result in injuries or damage to the machine.
- The included bobbin was designed specifically for this machine. If bobbins from other models are used, the machine will not operate correctly. Use only the included bobbin or bobbins of the same type (part code: SA156, SFB: XA5539-151). SA156 is Class15 type bobbin.

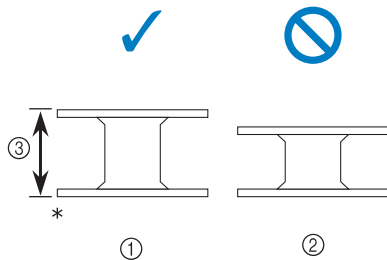

- * Actual size
- ① This model
 - ② Other models
 - ③ 11.5 mm (approx. 7/16 inch)

Winding the bobbin

This section describes how to wind thread onto a bobbin.

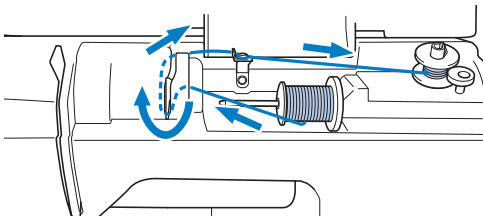

Memo

- When winding bobbin for embroidery be sure to use the recommended bobbin thread for this machine.

- 1 Open the top cover.

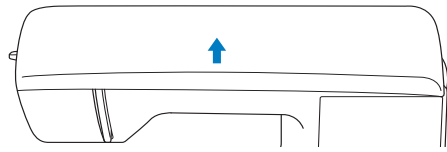

- 2 Place the bobbin on the bobbin winder shaft so that the spring on the shaft fits into the notch in the bobbin. Press down on the bobbin until it snaps into place.

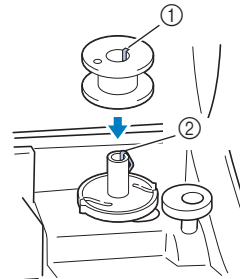

- ① Notch
- ② Bobbin winder shaft spring

- 3 Slide the bobbin winder in the direction of the arrow until it snaps into place.

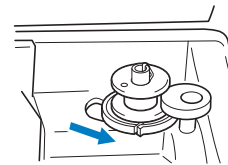

- The "Start/Stop" button lights up in orange.

- 4 Remove the spool cap that is inserted onto the spool pin.

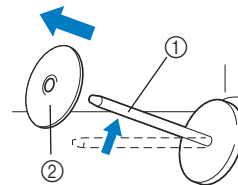

- ① Spool pin
- ② Spool cap

5 Place the spool of thread for the bobbin onto the spool pin.

Slide the spool onto the pin so that the spool is horizontal and the thread unwinds to the front at the bottom.

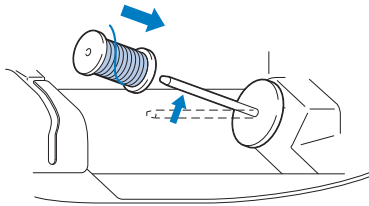

- If the spool is not positioned so that the thread unwinds correctly, the thread may become tangled around the spool pin.

6 Slide the spool cap onto the spool pin.

Slide the spool cap as far as possible to the right, as shown, with the rounded side on the left.

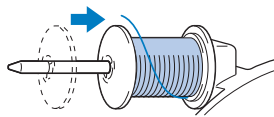

⚠ CAUTION

- If the spool or the spool cap is not installed correctly, the thread may become tangled around the spool pin, causing the needle to break.
- Three spool cap sizes are available, allowing you to choose a spool cap that best fits the size of spool being used. If the spool cap is too small for the spool being used, the thread may catch on the slit in the spool or the machine may be damaged.

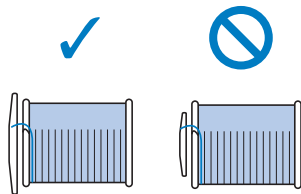

Memo

- When sewing with fine, cross-wound thread, use the small spool cap, and leave a small space between the cap and the spool.

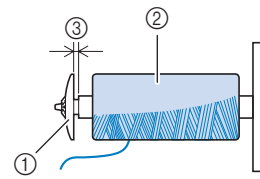

- ① Spool cap (small)
- ② Spool (cross-wound thread)
- ③ Space

- When using thread that winds off quickly, such as metallic thread, place the spool net over the spool before placing the spool of thread onto the spool pin. If the spool net is too long, fold it to fit the size of the spool.

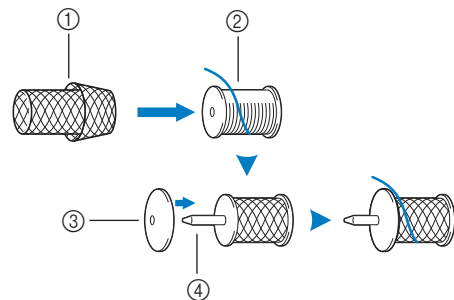

- ① Spool net
- ② Spool
- ③ Spool cap
- ④ Spool pin

- If a spool of thread whose core is 12 mm (1/2 inch) in diameter and 75 mm (3 inches) high is inserted onto the spool pin, use the thread spool insert (mini king thread spool).

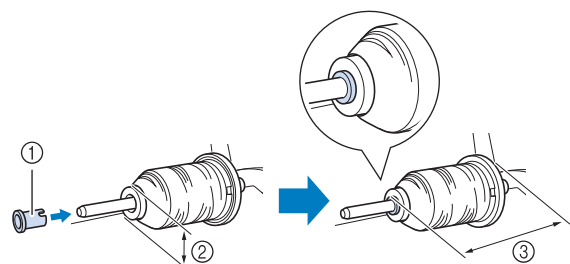

- ① Thread spool insert (mini king thread spool)
- ② 12 mm (1/2 inch)
- ③ 75 mm (3 inches)

- 7** While holding the thread near the spool with your right hand, as shown, pull the thread with your left hand, and then pass the thread behind the thread guide cover and to the front.

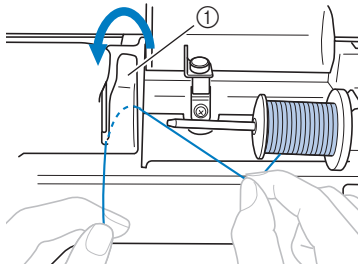

① Thread guide cover

- 8** Pass the thread under the thread guide plate, and then pull it to the right.

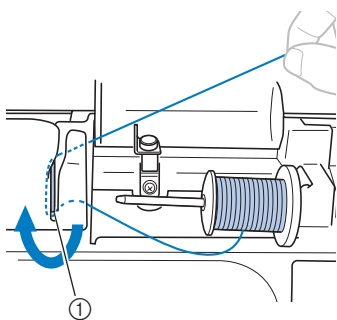

① Thread guide plate

- 9** Pass the thread under the hook on the thread guide, and then wind it counterclockwise under the pretension disk.

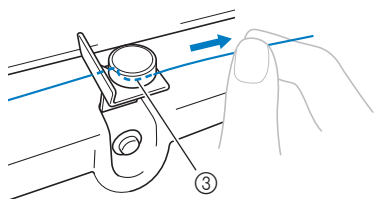
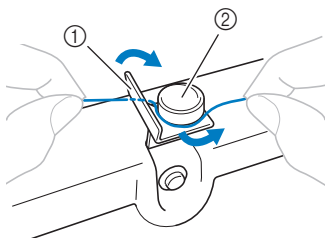

① Thread guide
② Pretension disk
③ Pull it in as far as possible



Note

- Make sure that the thread passes under the pretension disk.

- 10** While holding the thread with your left hand, wind the thread that was pulled out clockwise around the bobbin five or six times with your right hand.

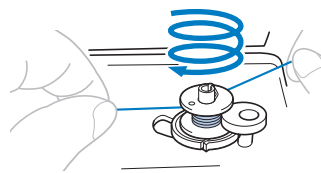

Note

- Make sure that the thread between the spool and the bobbin is pulled tight.
- Be sure to wind the thread clockwise around the bobbin, otherwise the thread will become wrapped around the bobbin winder shaft.

- 11** Pass the end of the thread through the guide slit in the bobbin winder seat, and then pull the thread to the right to cut it.

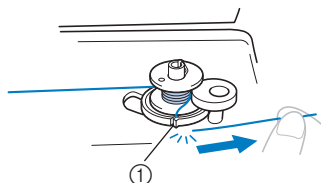

① Guide slit in bobbin winder seat (with built-in cutter)

CAUTION

- Be sure to cut the thread as described. If the bobbin is wound without cutting the thread using the cutter built into the slit in the bobbin winder seat, the thread may become tangled in the bobbin or the needle may bend or break when the bobbin thread starts to run out.

- 12** Turn on the machine.

- 13** Press the “Start/Stop” button once to start winding the bobbin.

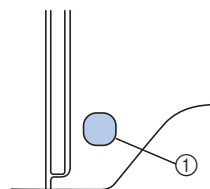

① “Start/Stop” button

- 14** When the bobbin winding becomes slow, press the “Start/Stop” button once to stop the machine.

CAUTION

- When the bobbin winding becomes slow, stop the machine, otherwise the machine may be damaged.

- 15 Use scissors to cut the end of the thread wound around the bobbin.

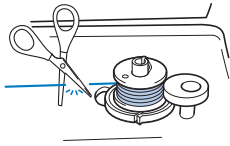

- 16 Slide the bobbin winder shaft to the left, and then remove the bobbin from the shaft.

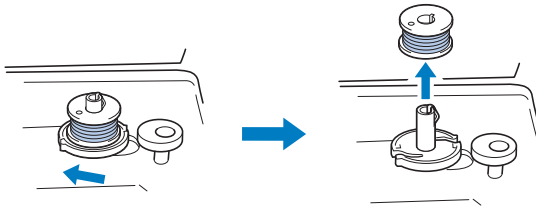

Memo

- If the bobbin winder shaft is set to the right side, the needle will not move. (Embroidering is impossible.)

- 17 Remove the spool for the bobbin thread from the spool pin.

Memo

- When the machine is started or the handwheel is turned after winding the bobbin, the machine will make a clicking sound; this is not a malfunction.

Installing the bobbin

Install the bobbin wound with thread.
You can begin embroidering immediately without pulling up the bobbin thread by simply inserting the bobbin in the bobbin case and guiding the thread through the slit in the needle plate cover.

⚠ CAUTION

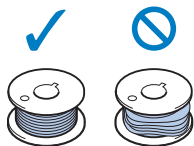

- Use a bobbin that has been correctly wound with thread, otherwise the needle may break or the thread tension will be incorrect.



- Before inserting or changing the bobbin, be sure to press  on the operation panel to lock all keys and buttons, otherwise injuries may occur if the "Start/Stop" button or any other button is pressed and the machine starts.

- 1 Press  (Needle position button) once or twice to raise the needle.

- 2 Press .

- When the message "OK to automatically lower the presser foot?" appears on the LCD screen, press  to continue.
- The screen changes, and all keys and operation buttons are locked (except .

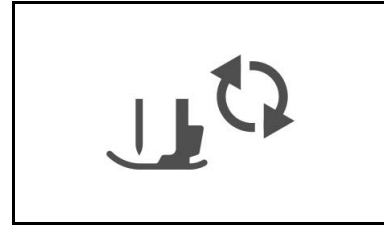

- 3 Raise the presser foot lever.

- 4 Slide the bobbin cover latch to the right.

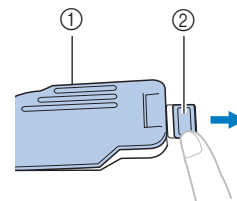

- ① Bobbin cover
② Latch

- 5 Remove the bobbin cover.

- 6 Hold the bobbin with your right hand with the thread unwinding to the left, and hold the end of the thread with your left hand. Then, with your right hand, place the bobbin in the bobbin case.

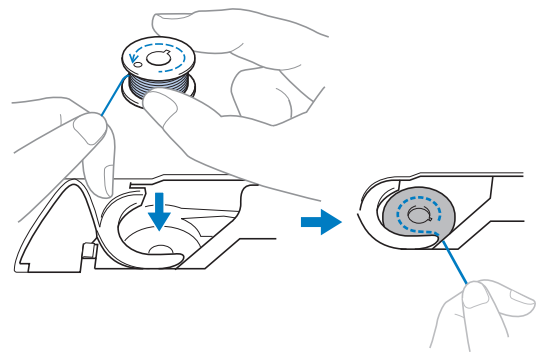

- 7** Lightly hold down the bobbin with your right hand (1), and then guide the end of the thread around the tab of the needle plate cover with your left hand (2).

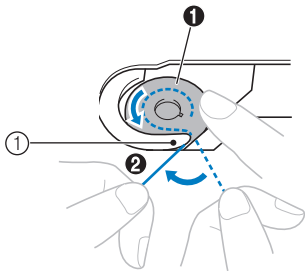

① Tab

⚠ CAUTION

- Be sure to hold down the bobbin with your finger and unwind the bobbin thread correctly, otherwise the thread may break or the thread tension will be incorrect.

📖 Memo

- The order that the bobbin thread should be passed through the bobbin case is indicated by marks around the bobbin case. Be sure to thread the machine as indicated.

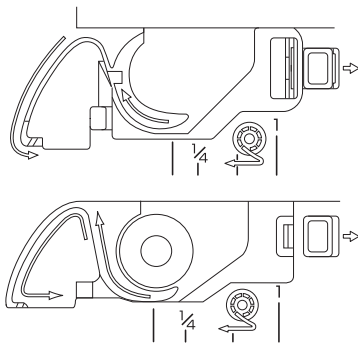

- 8** While lightly holding down the bobbin with your right hand (1), guide the thread through the slit in the needle plate cover (2) and lightly pull it with your left hand (3).

- The thread enters the tension spring of the bobbin case.

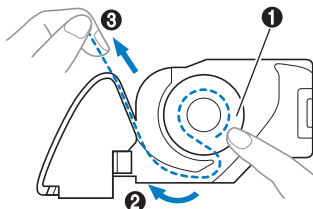

- 9** While lightly holding down the bobbin with your right hand (1), continue guiding the thread through the slit with your left hand (2). Then, cut the thread with the cutter (3).

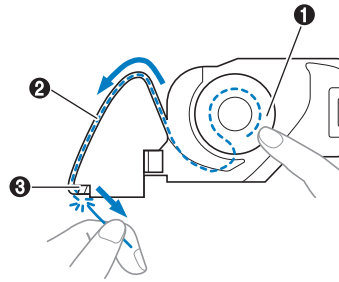

💡 Note

- If the thread is not correctly inserted through the tension-adjusting spring of the bobbin case, it may cause incorrect thread tension.

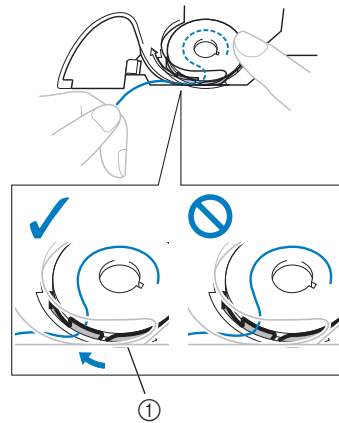

① Tension-adjusting spring

- 10** Reattach the bobbin cover.

Insert the tab in the lower-left corner of the bobbin cover, and then lightly press down on the right side.

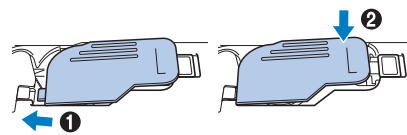

→ The bobbin threading is finished.

Next, thread the upper thread. Continue with the procedure in "Upper Threading" on page B-19.

- 11** Press  to unlock all keys and buttons.

Upper Threading

⚠ CAUTION

- Three spool cap sizes are available, allowing you to choose a spool cap that best fits the size of spool being used. If the spool cap is too small for the spool being used, the thread may catch on the slit in the spool or the needle may break. For more information regarding the choice of spool caps for your thread choice, see page B-15.

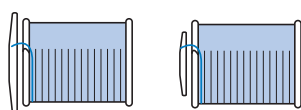

- When threading the upper thread, carefully follow the instructions. If the upper threading is not correct, the thread may become tangled or the needle may bend or break.
- Never use a thread weight of 20 or lower.

Threading the upper thread

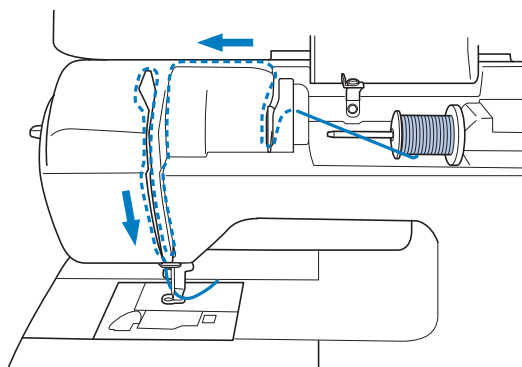

- 1 Turn on the machine.
- 2 Raise the presser foot lever to raise the presser foot.

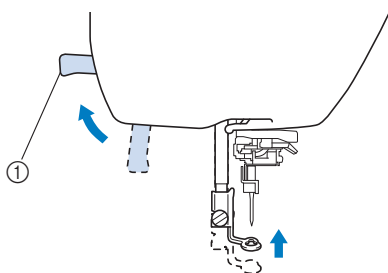

① Presser foot lever

→ The upper thread shutter opens so the machine can be threaded.

**Note**

- If the presser foot is not raised, the machine cannot be threaded.

- 3 Press  (Needle position button) once or twice to raise the needle.

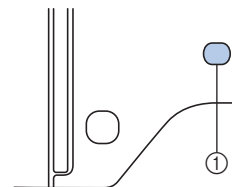

① Needle position button

→ The needle is correctly raised when the mark on the handwheel is at the top, as shown below. Check the handwheel and, if this mark is not at this position, press  (Needle position button) until it is.

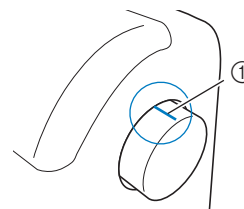

① Mark on handwheel

- 4 Remove the spool cap that is inserted onto the spool pin.

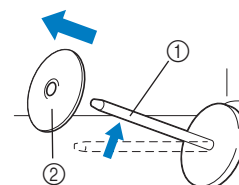

① Spool pin
② Spool cap

- 5 Place the spool of thread onto the spool pin.

Slide the spool onto the pin so that the spool is horizontal and the thread unwinds to the front at the bottom.

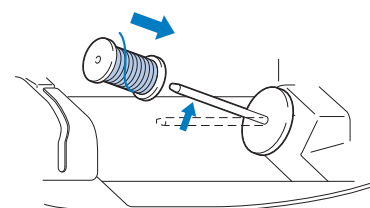
**⚠ CAUTION**

- If the spool or the spool cap is not positioned correctly, the thread may become tangled around the spool pin or the needle may break.

B

GETTING READY

- 6 Slide the spool cap onto the spool pin.**
Slide the spool cap as far as possible to the right, as shown, with the rounded side on the left.

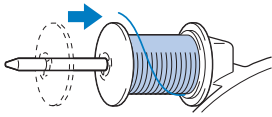

- 7 While holding the thread lightly with your right hand, pull the thread with your left hand, and then pass the thread behind the thread guide cover and to the front.**

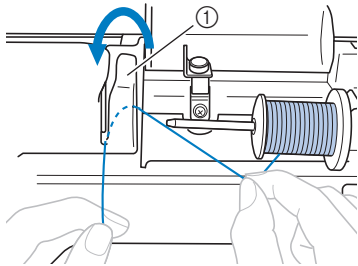

① Thread guide cover

- 8 Pass the thread under the thread guide plate, and then pull it up.**

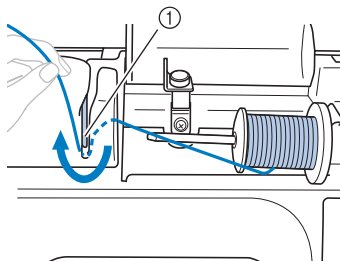

① Thread guide plate

- 9 While using your right hand to lightly hold the thread passed under the thread guide plate, pass the thread through the guides in the order shown below.**

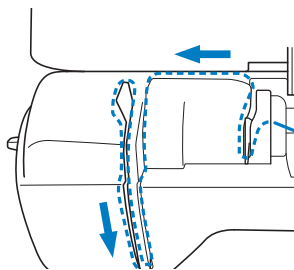

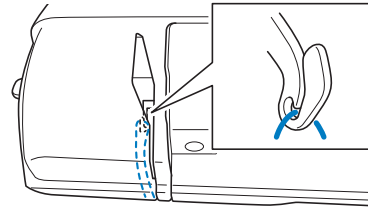

Note

- If the presser foot has been lowered and the shutter is closed, the machine cannot be threaded. Be sure to raise the presser foot to open the shutter before threading the machine. In addition, before removing the upper thread, be sure to raise the presser foot to open the shutter.
- This machine is equipped with a window that allows you to check the position of the take-up lever. Look through this window and check that the thread is correctly fed through the take-up lever.



- 10 Press .**

- When the message “OK to automatically lower the presser foot?” appears on the LCD screen, press  to continue.
- The screen changes, and all keys and operation buttons are locked (except .

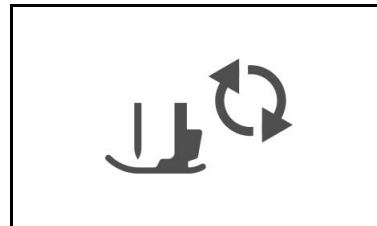

- 11 Slide the thread behind the needle bar thread guide.**

The thread can easily be slid behind the needle bar thread guide by holding the thread in your left hand, then feeding the thread with your right hand, as shown.

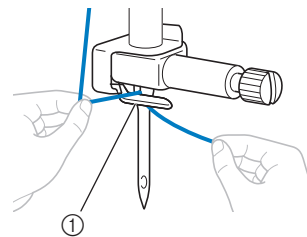

① Needle bar thread guide

- 12 Raise the presser foot lever.**

Threading the needle

Memo

- The needle threader can be used with machine needles 75/11 through 100/16.
- If the needle threader cannot be used, refer to “Threading the needle manually (without using the needle threader)” on page B-22.

- 1 Pull the end of the thread, which has been passed through the needle bar thread guide, to the left, then pass the thread through the notch of the threader thread guide ①, and then firmly pull the thread from the front and insert it into the slit of the threader thread guide disk marked “7” all the way ②.

- Make sure that the thread passes through the notch of the threader thread guide.

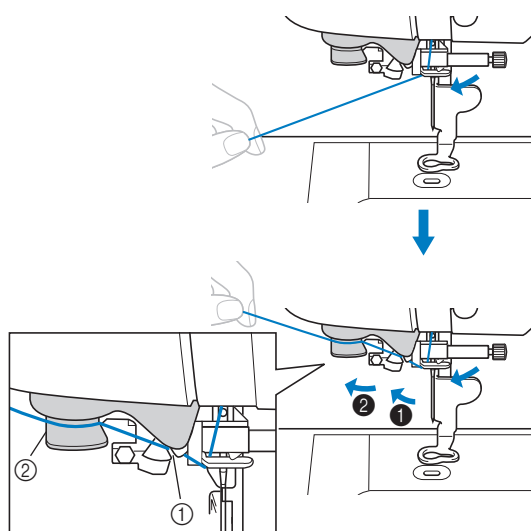

- ① Notch of the threader thread guide
- ② Threader thread guide disk

- 2 Cut the thread with the cutter on the left side of the machine.

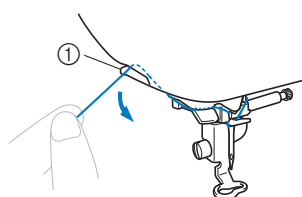

- ① Cutter

Note

- If the thread is pulled through and cannot be cut correctly, lower the presser foot lever so that the thread is held in place before cutting the thread. If this operation is performed, skip step ③.
- When using thread that quickly winds off the spool, such as metallic thread, it may be difficult to thread the needle if the thread is cut. Therefore, instead of using the thread cutter, pull out about 80 mm (approx. 3 inches) of thread after passing it through the threader thread guide disks (marked “7”).

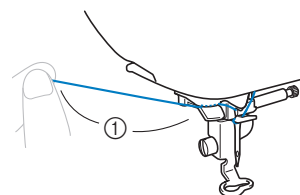

- ① 80mm or more (approx. 3 inches)

- 3 Lower the presser foot lever to lower the presser foot.

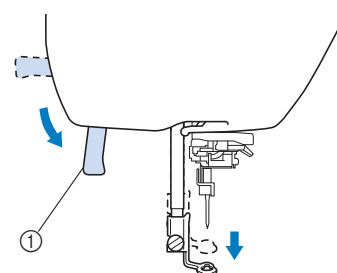

- ① Presser foot lever

- 4 Lower the needle threader lever on the left side of the machine until it clicks, and then slowly return the lever to its original position.

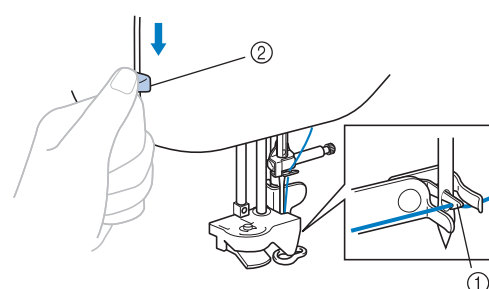

- ① Hook
- ② Needle threader lever

→ The hook is rotated and passes the thread through the eye of the needle.

Note

- If the needle is not raised to its highest position, the needle threader cannot thread the needle. Turn handwheel counterclockwise until the needle is at its highest position. The needle is correctly raised when the mark on the handwheel is at the top, as shown under step ③ on page B-19.

- 5 Carefully pull the end of thread that was passed through the eye of the needle.

If the needle was not completely threaded, but a loop in the thread was formed in the eye of the needle, carefully pull the loop through the eye of the needle to pull out the end of the thread.

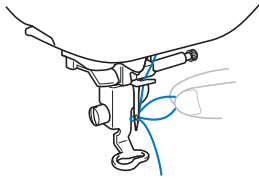

⚠ CAUTION

- When pulling out the thread, do not pull it with extreme force, otherwise the needle may break or bend.

- 6 Raise the presser foot lever, pass the end of the thread through and under the presser foot, and then pull out about 5 cm (approx. 2 inches) of thread toward the rear of the machine.

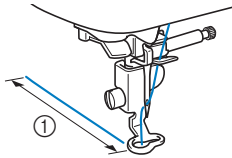

① 5 cm (approx. 2 inches)

- 7 Press  to unlock all keys and buttons.

Threading the needle manually (without using the needle threader)

Some needles cannot be threaded with the needle threader. In this case, thread the needle as described below.

- 1 Thread the machine to the needle bar thread guide.
 - For details, refer to “Upper Threading” on page B-19.
- 2 Insert the thread through the eye of the needle from front to back.

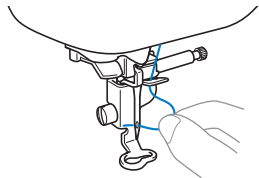

- 3 Raise the presser foot lever, pass the end of the thread through and under the presser foot, and then pull out about 5 cm (approx. 2 inches) of thread toward the rear of the machine.
- 4 Press  to unlock all keys and buttons.

Replacing the Needle

Be sure to observe the following precautions concerning the handling of the needle. Failure to observe these precautions is extremely dangerous, for example, if the needle breaks and fragments are dispersed. Be sure to read and carefully follow the instructions below.

⚠ CAUTION

- Only use recommended home machine needles. Use of any other needle may bend the needle or damage the machine.
- Never use bent needles. Bent needles can easily break, possibly resulting in injuries.



Note

- Never use thread of 20 weight or lower. It may cause the machine to malfunction.

■ Thread and needle number

The lower the thread number is, the heavier the thread; the higher the needle number, the larger the needle.

■ Embroidery needles

Use a 75/11 home machine needle. When embroidering on heavier fabrics such as denim, use a 90/14 or 100/16 home machine needle.

Checking the needle

Sewing with a bent needle is extremely dangerous since the needle may break while the machine is being operated.

Before using the needle, place the flat side of the needle on a flat surface and check that the distance between the needle and the flat surface is even.

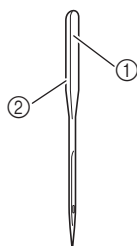

- ① Flat side
- ② Needle type marking

⚠ CAUTION

- If the distance between the needle and the flat surface is not even, the needle is bent. Do not use a bent needle.

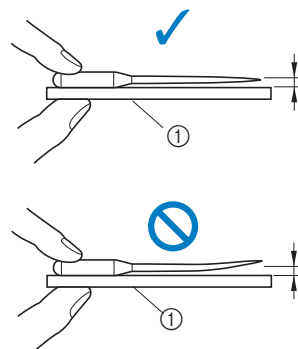

① Flat surface

Replacing the needle

Use the screwdriver and a needle that has been determined to be straight according to the instructions in “Checking the needle”.

- 1 Press (Needle position button) once or twice to raise the needle.
- 2 Place fabric or paper under the presser foot to cover the hole in the needle plate.



Note

- Before replacing the needle, cover the hole in the needle plate with fabric or paper to prevent the needle from falling into the machine.

- 3 Press .
 - When the message “OK to automatically lower the presser foot?” appears on the LCD screen, press to continue.
 - The screen changes, and all keys and operation buttons are locked (except).

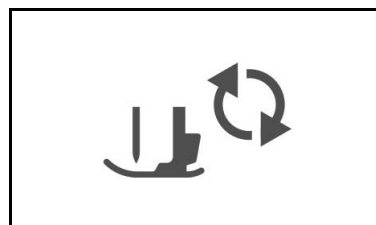

4 Hold the needle with your left hand, and then use a screwdriver to turn the needle clamp screw toward you (counterclockwise) to remove the needle.

- The needle clamp screw can also be loosened or tightened with the L-shaped (or disc-shaped) screwdriver.

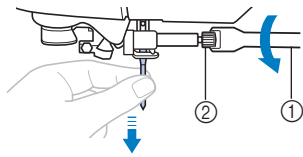

- ① Screwdriver
- ② Needle clamp screw

- Do not apply a strong force when loosening or tightening the needle clamp screw, otherwise certain parts of the machine may be damaged.

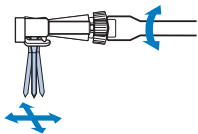

5 With the flat side of the needle toward the rear of the machine, insert the needle until it touches the needle stopper.

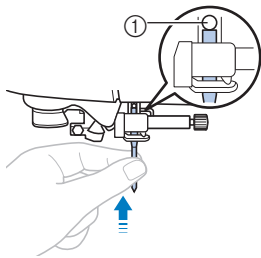

- ① Needle stopper

6 While holding the needle with your left hand, use the screwdriver to tighten the needle clamp screw by turning it clockwise.

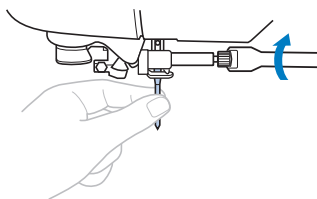

⚠ CAUTION

- Be sure to insert the needle until it touches the needle stopper and securely tighten the needle clamp screw with the screwdriver, otherwise the needle may break or damage may result.

7 Press  to unlock all keys and buttons.

Chapter 2 STARTING TO EMBROIDER

Embroidery Step by Step

Follow the steps below to prepare the machine for embroidery.

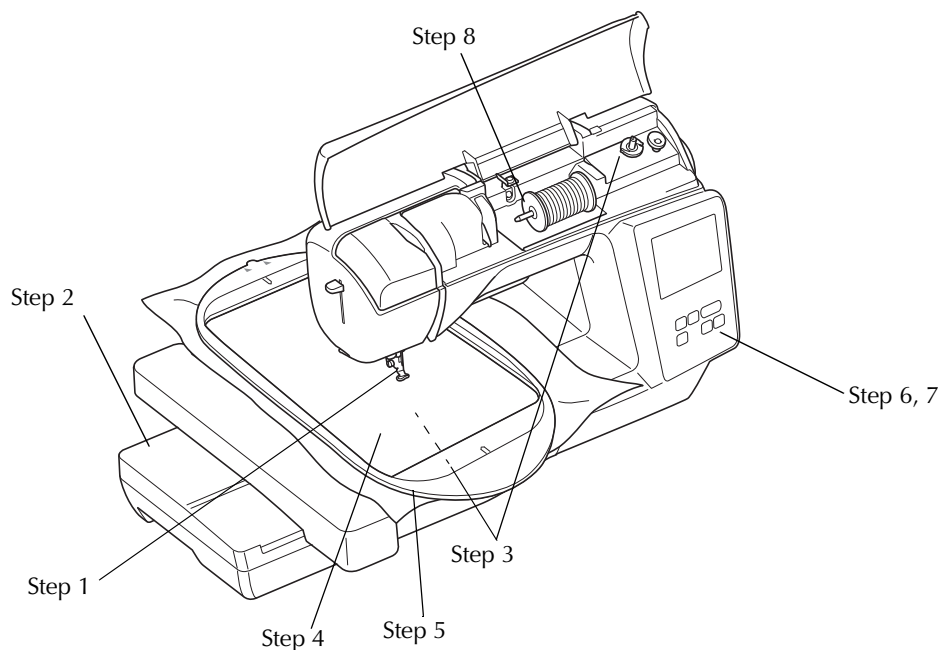

B

STARTING TO EMBROIDER

Step #	Aim	Action	Page
1	Checking the needle	Use needle 75/11 for embroidery. *	B-23
2	Embroidery unit attachment	Attach the embroidery unit.	B-26
3	Bobbin thread setup	For the bobbin thread, wind embroidery bobbin thread and set it in place.	B-17
4	Fabric preparation	Attach a stabilizer material to the fabric, and hoop it in the embroidery frame.	B-29
5	Embroidery frame attachment	Attach the embroidery frame to the embroidery unit.	B-35
6	Pattern selection	Turn the main power to on, and select an embroidery pattern.	B-9
7	Checking the layout	Check and adjust the size and position of the embroidery.	B-35
8	Embroidery thread setup	Set up embroidery thread according to the pattern.	B-28

* It is recommended that a 90/14 needle should be used when embroidering on heavy weight fabrics or stabilizing products (for example; denim, puffy foam, etc.).

Attaching the Embroidery Unit

⚠ CAUTION

- Do not move the machine with the embroidery unit in place. The embroidery unit may be dropped and cause injury.
- Keep your hands and other objects away from the embroidery carriage and frame. Otherwise injury may result.

💡 Note

- Do not touch the connector in the embroidery unit connector slot. The connector could be damaged, and it may cause malfunctions.
- Do not lift up on the embroidery carriage, and do not forcefully move it. It may cause malfunctions.

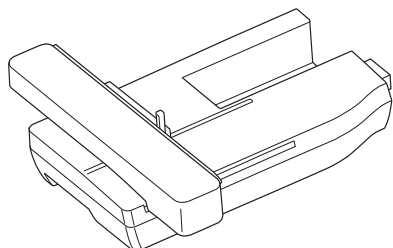
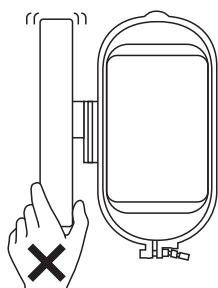

1 Turn off the machine.

⚠ CAUTION

- Before attaching the embroidery unit, be sure to turn off the machine. Otherwise, injuries may occur if one of the operation buttons is accidentally pressed and the machine starts sewing.

2 Slide the tab on the cover of the connection port in the direction of the arrow to open the cover.

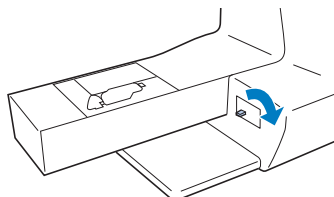

💡 Note

- Be sure to close the cover of the connection port when the embroidery unit is not being used.

3 Insert the embroidery unit connector into the connection port, and then lightly push in the embroidery unit until it snaps into place.

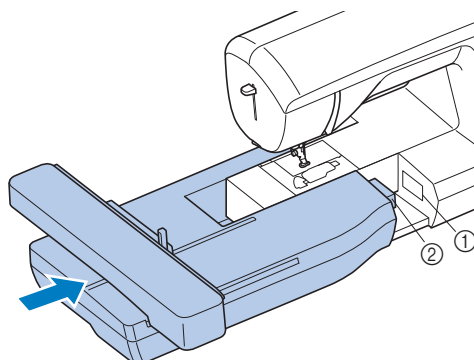

- ① Connection port
- ② Embroidery unit connector

💡 Note

- Make sure that there is no gap between the embroidery unit and the machine, otherwise the embroidery pattern may not be sewn correctly. Be sure to fully insert the connector into the connection port.
- Do not push on the carriage when attaching the embroidery unit to the machine, otherwise damage to the embroidery unit may result.

4 Turn on the machine.

→ A message appears in the screen.

5 Be sure that no objects or hands are near the embroidery unit and press **OK**.

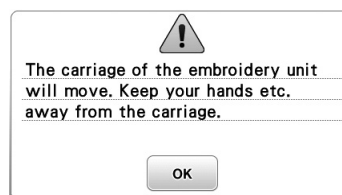

→ The carriage moves to its initial position.

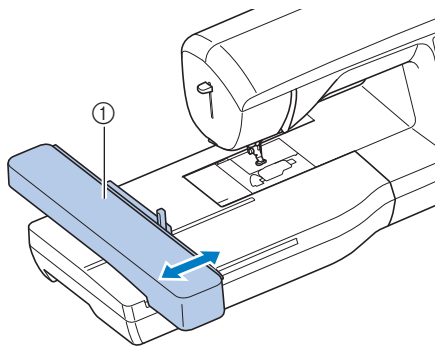

① Carriage

⚠ CAUTION

- Keep your hands and foreign objects away from the embroidery carriage and frame when the machine is embroidering. Otherwise, injury may result.

Note

- If the machine was not initialized correctly, the initial screen may not appear. This is not a sign of a malfunction. If this occurs, turn the machine off, then on again.
- A confirmation message to lower the frame-securing lever after the carriage moves to its initial position is displayed. Continue with pattern selection and remember to lower the frame-securing lever when the embroidery frame is attached.

→ The screen for selecting the embroidery pattern type is displayed.

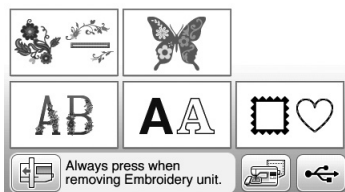

- For details on the embroidery patterns, refer to "Viewing the LCD" on page B-9.

■ Removing the embroidery unit

Make sure that the machine is completely stopped and follow the instructions below.

1 Remove the embroidery frame.

- For details on removing the embroidery frame, refer to "Attaching the Embroidery Frame" on page B-33.

2 Press , and then press .

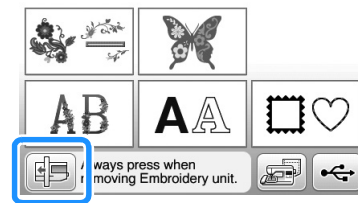

→ The embroidery carriage moves into a position where it can be stored.

3 Turn off the machine.

⚠ CAUTION

- Always turn off the machine before removing the embroidery unit. It may cause malfunctions if removed when the machine is turned on.

4 Hold the release button on the bottom left of the embroidery unit, and slowly pull the embroidery unit to the left.

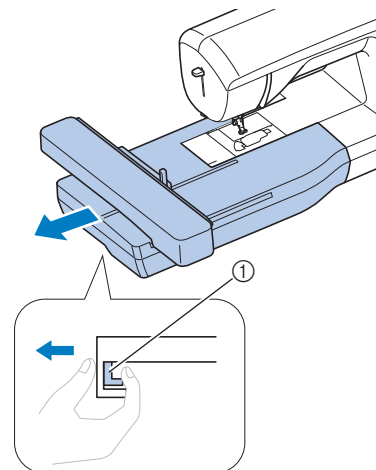

① Release button

⚠ CAUTION

- Do not carry the embroidery unit by holding the release button compartment.

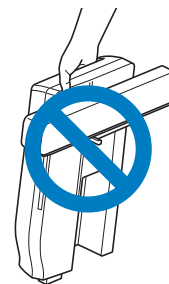

Embroidery Attractive Finishes

There are many factors that go into beautiful embroidery. Using the appropriate stabilizer (see page B-29) and hooping the fabric in the frame (see page B-30) are two important factors mentioned earlier. Another important point is the appropriateness of the needle and thread being used. See the explanation of threads below.

■ Thread

Upper thread	Use embroidery thread intended for use with this machine. Other embroidery threads may not yield optimum results.
Bobbin thread	Use embroidery bobbin thread intended for use with this machine.

Note

- Before embroidering, check that there is enough thread in the bobbin. If you start to sew your embroidery project without enough thread in the bobbin, you will need to rewind the bobbin in the middle of the embroidery pattern.

Memo

- If you use threads other than those listed above, the embroidery may not sew out correctly.

■ Bobbin case

Bobbin case (recommended for embroidering with included 90 weight bobbin thread)

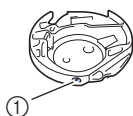

- ① Bobbin case
(no color on the screw)

The bobbin case included with this machine has been set to be used with 90 weight bobbin thread. If different weights of bobbin threads are used the tension screws on this case can be adjusted if necessary. For details on adjusting thread tension, refer to “Adjusting thread tension” in the “Embroidering” section.

- See “Cleaning the Race” in the “Appendix” section for how to remove the bobbin case.

⚠ CAUTION

- **When embroidering on large garments (especially jackets or other heavy fabrics), do not let the fabric hang over the table. Otherwise, the embroidery unit cannot move freely and the embroidery frame may strike the needle, causing the needle to bend or break and possibly cause injury. Place the fabric so that it does not hang off the table or hold the fabric to keep it from dragging.**

Note

- Do not leave objects in the range of motion of the embroidery frame. The frame may strike the object and cause a poor finish to the embroidery pattern.
- When embroidering on large garments (especially jackets or other heavy fabrics), do not let the fabric hang over the table. Otherwise, the embroidery unit cannot move freely, and the pattern may not turn out as planned.

Preparing the Fabric

⚠ CAUTION

- Use fabrics with a thickness of less than 3 mm (approx. 1/8 inch). Using fabrics thicker than 3 mm (approx. 1/8 inch) may cause the needle to break.
- When using layers with thicker batting etc., you can sew more attractive embroidery by adjusting the embroidery presser foot height in the embroidery settings screen (see below).
- In the case of thick terry cloth towels we recommend that you place a piece of water soluble stabilizer on the top surface of the towel. This will help to reduce the nap of the toweling and result in more attractive embroidery.



Note

- Press . In the "Embroidery Foot Height" display, use and in the settings screen. Adjust the presser foot height for thick or puffy fabrics.

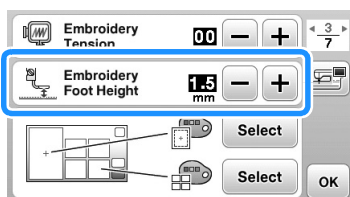

- To increase the space between the presser foot and the needle plate, set the embroidery foot height to a larger number, 1.5 mm setting is used for most embroidery.

Attaching iron-on stabilizers (backing) to the fabric

For best results in your embroidery projects, always use stabilizer material for embroidery. Follow the package instructions for the stabilizer being used.

When using fabrics that cannot be ironed (such as terry cloth or fabrics that have loops which expand when ironed) or in places where ironing is difficult, position the stabilizer material under the fabric without fusing it, then position the fabric and stabilizer in the embroidery frame, or check with your authorized Brother dealer for the correct stabilizer to use.

⚠ CAUTION

- Always use a stabilizer material for embroidery when sewing stretch fabrics, lightweight fabrics, fabrics with a coarse weave, or fabrics which cause pattern shrinkage. Otherwise, the needle may break and cause injury. Not using a stabilizer material may result in a poor finish to your project.

- 1 Use a piece of stabilizer which is larger than the embroidery frame being used.

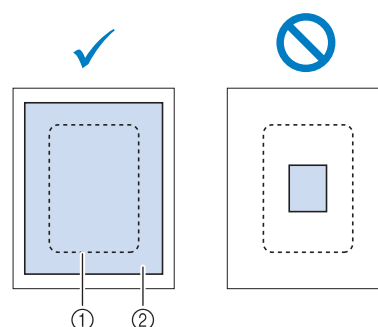

- ① Size of the embroidery frame
- ② Iron-on stabilizer (backing)

- 2 Iron the iron-on stabilizer material to the wrong side of the fabric.

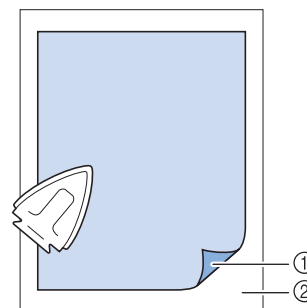

- ① Fusible side of stabilizer
- ② Fabric (wrong side)



Memo

- When embroidering on thin fabrics such as organdy or lawn, or on napped fabrics such as terry cloth or corduroy, use water soluble stabilizer (sold separately) for best results. The water soluble stabilizer material will dissolve completely in water, giving the project a more attractive finish.

Hooping the fabric in the embroidery frame

Types of embroidery frames

The types and numbers of supplied embroidery frames will differ depending on the machine model.

Extra Large

Embroidery field 26 cm × 16 cm
(10 - 1/4 inches × 6 - 1/4 inches)

Use when embroidering connected or combined characters or patterns, or when embroidering large patterns.

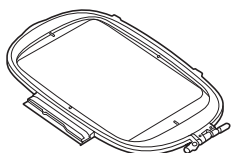

Large (sold separately with some models)

Embroidery field 18 cm × 13 cm (7 inches × 5 inches)

Use when embroidering patterns between 10 cm × 10 cm (4 inches × 4 inches) and 18 cm × 13 cm (7 inches × 5 inches).

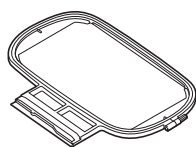

Medium (sold separately with some models)

Embroidery field 10 cm × 10 cm (4 inches × 4 inches)

Use when embroidering patterns under 10 cm × 10 cm (4 inches × 4 inches).

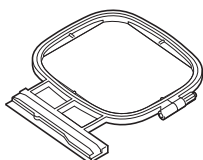

Small (sold separately with some models)

Embroidery field 2 cm × 6 cm (1 inch × 2 - 1/2 inches)

Use when embroidering small sized patterns, such as name tags.

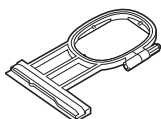

Other optional embroidery frames can be used. When choosing frames that do not appear on the screen, be sure to check the design size of the embroidery field of the optional frame. Check with your authorized Brother dealer for frame compatibility.

Select a frame that is slightly larger than the pattern size. Included frame options are displayed on the screen.

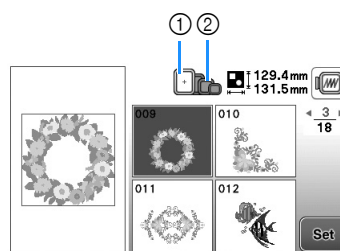

- ① Highlighted: Can be used
- ② Shaded: Cannot be used

CAUTION

- If you use a frame that is too small, the presser foot may strike the frame during sewing and cause injury or may damage your machine.

Inserting the Fabric



Note

- If the fabric is not securely held in the embroidery frame, the embroidery design will sew out poorly. Insert the fabric on a level surface, and gently stretch the fabric taut in the frame. Follow the steps below to insert the fabric correctly.

- 1 Lift-up and loosen the frame adjustment screw and remove the inner frame.

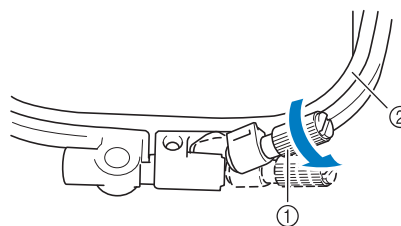

- ① Frame adjustment screw
- ② Inner frame

- 2** Lay the fabric right side up on top of the outer frame.
Re-insert the inner frame making sure to align the inner frame's \triangle with the outer frame's ∇ .

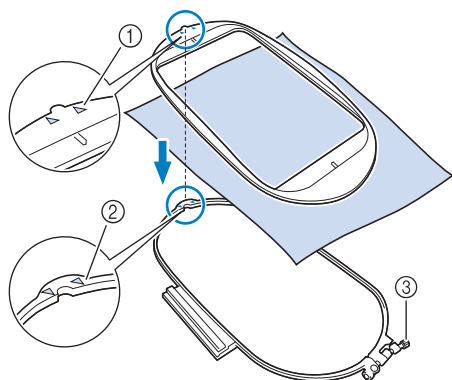

- ① Inner frame's \triangle
- ② Outer frame's ∇
- ③ Frame adjustment screw

- 3** Slightly tighten the frame adjustment screw, and then remove the slack in the fabric by gently pulling on the edges and corners. Do not loosen the screw.

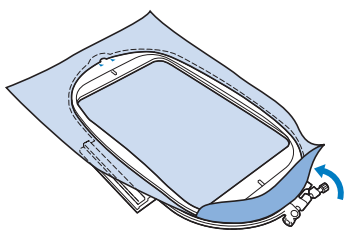

- 4** Gently stretch the fabric taut, and tighten the frame adjustment screw to keep the fabric from loosening after stretching.

- After stretching the fabric, make sure the fabric is taut.

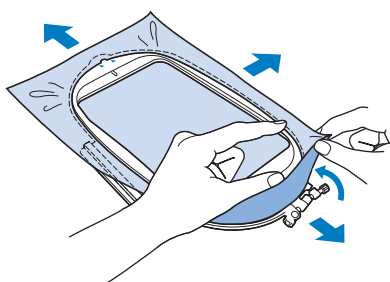

- Make sure the inside and outside frames are even before you start embroidering.

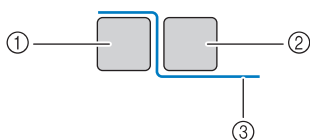

- ① Outer frame
- ② Inner frame
- ③ Fabric

Memo

- After stretching the fabric, lightly tapping it should produce a drum-like sound.
- Stretch the fabric from all four corners and all four edges. While stretching the fabric, tighten the frame adjustment screw.

- 5** Return the frame adjustment screw to its initial position.

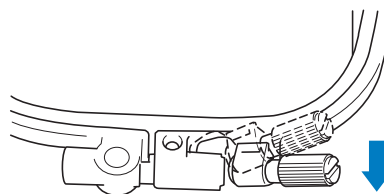

Memo

- You can use the included screwdriver when you loosen or tighten the frame adjustment screw.

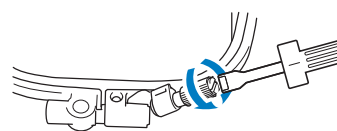

Using the embroidery sheet

When you want to embroider the pattern in a particular place, use the embroidery sheet with the frame.

- 1** With a chalk pencil, mark the area of the fabric you want to embroider.

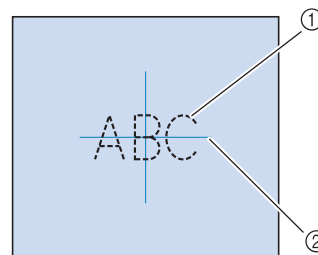

- ① Embroidery pattern
- ② Mark

- 2** Place the embroidery sheet on the inner frame. Align the guide lines on the embroidery sheet with the mark you made on the fabric.

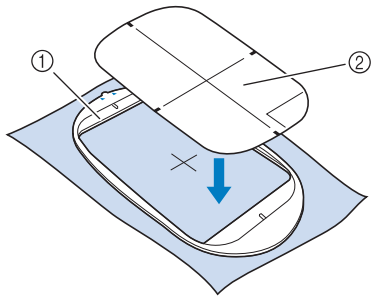

- ① Inner frame
- ② Guide line

- 3** Gently stretch the fabric so there are no folds or wrinkles, and press the inner frame into the outer frame.

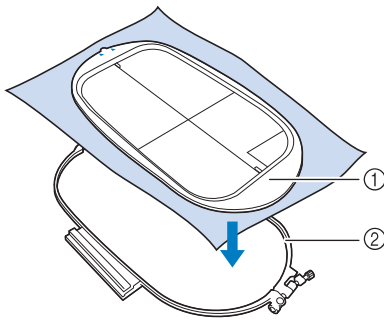

- ① Inner frame
- ② Outer frame

- 4** Remove the embroidery sheet.

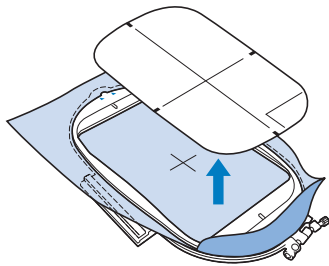

Embroidering small fabrics or fabric edges

Use an embroidery stabilizer to provide extra support. After embroidering, remove the stabilizer carefully. Attach the stabilizer as shown in the following examples. We recommend using a stabilizer for embroidery.

Embroidering small fabrics

Use a temporary spray adhesive to adhere the small piece of fabric to the larger piece in the frame.

If you do not wish to use a temporary spray adhesive, attach the stabilizer with a basting stitch.

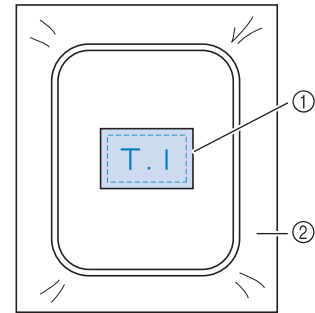

- ① Fabric
- ② Stabilizer

Embroidering edges or corners

Use a temporary spray adhesive to adhere the small piece of fabric to the larger piece in the frame.

If you do not wish to use a temporary spray adhesive, attach the stabilizer with a basting stitch.

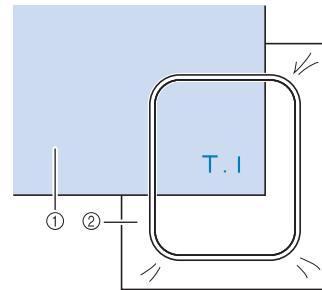

- ① Fabric
- ② Stabilizer

Embroidering ribbons or tape

Secure with double-sided tape or a temporary spray adhesive.

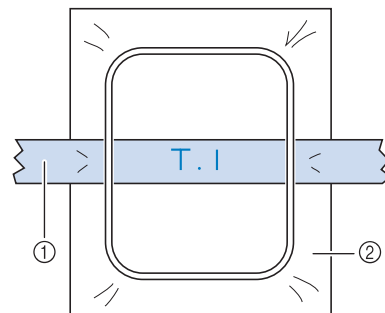

- ① Ribbon or tape
- ② Stabilizer

Attaching the Embroidery Frame



Note

- Wind and insert the bobbin before attaching the embroidery frame making sure to use the recommended bobbin thread.

1 Press  (Presser foot lifter button) to raise the presser foot.

2 Raise the frame-securing lever.

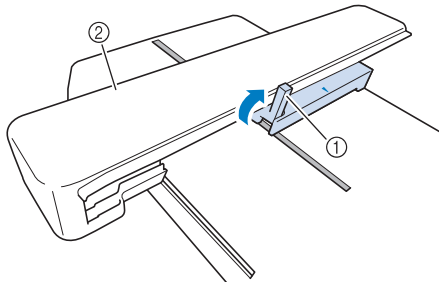

- ① Frame-securing lever
② Carriage

3 Align the embroidery frame guide with the right edge of the embroidery frame holder.

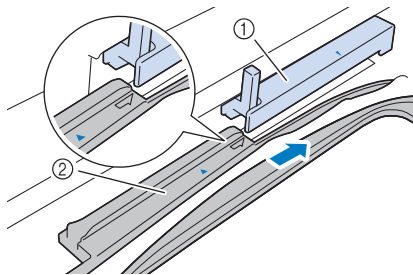

- ① Embroidery frame holder
② Embroidery frame guide

4 Slide the embroidery frame into the holder, making sure to align the embroidery frame's arrow mark with the one on holder.

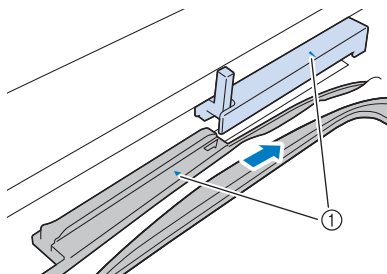

- ① Arrow mark

5 Lower the frame-securing lever to be level with the frame to secure the embroidery frame in the embroidery frame holder.

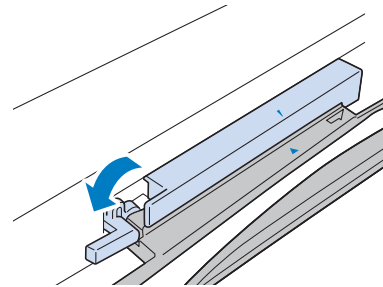

CAUTION

- If the frame-securing lever is not lowered, the following message appears. You cannot start sewing until you lower the frame-securing lever.

Make sure embroidery frame is moved as far back as possible. LOCK DOWN THE FRAME-SECURING LEVER.

OK

Removing the embroidery frame

1 Press  (Presser foot lifter button) to raise the presser foot.

2 Raise the frame-securing lever.

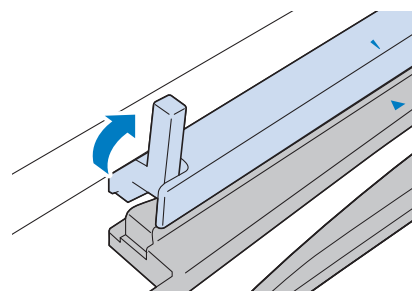

3 Pull the embroidery frame toward you.

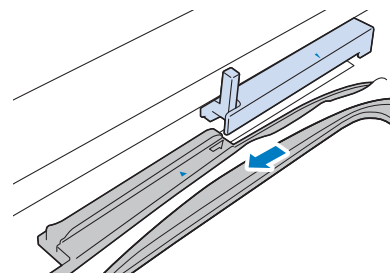

Selecting Embroidery Patterns

Copyright information

The patterns stored in the machine are intended for private use only. Any public or commercial use of copyrighted patterns is an infringement of copyright law and is strictly prohibited.



Embroidery pattern types

There are many character and decorative embroidery patterns stored in the machine's memory (see the "Embroidery Design Guide" for a full summary of patterns in the machine's memory). You can also use patterns from USB flash drive (sold separately).

- For details on the embroidery patterns, refer to "Viewing the LCD" on page B-9.



Selecting an embroidery pattern

Select a simple pattern built-in your machine and embroider for testing purposes. You can try various selection of patterns and pattern editing in the "Embroidering" section.

- 1 Press  in the pattern type selection screen and then press .

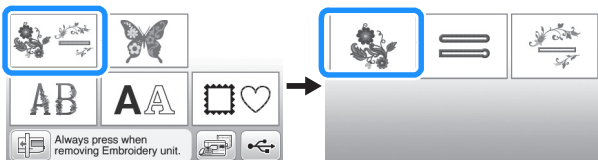
- Once the machine has finished the initialization and the carriage has moved to the start position, the pattern type selection screen will display. If another screen is displayed, press  to display the screen below.



- 2 Press  or  to display the desired pattern on the screen. Press  4 times in this procedure.

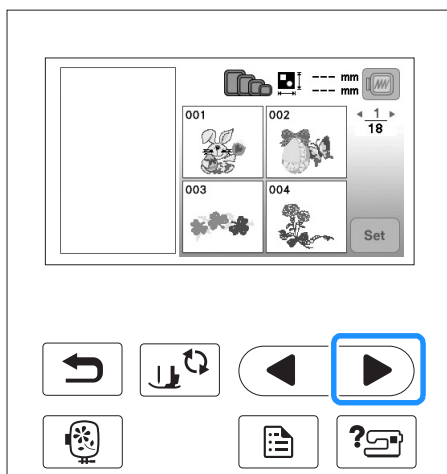

- 3 Press , and then .

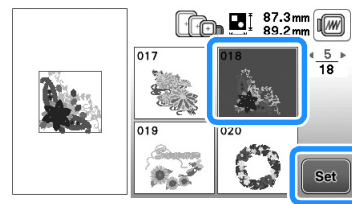

→ Pattern editing screen appears.

- 4 Press .

- For details on pattern editing screen, refer to "Editing Patterns" in the "Embroidering" section.

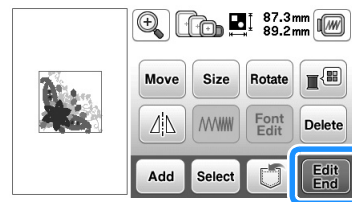

→ Embroidery settings screen appears.

- 5 Press .

- For details on embroidery settings screen, refer to "Editing Patterns" in the "Embroidering" section.
- Confirm the pattern position to be sewn, referring to "Confirming the Pattern Position" on page B-35.

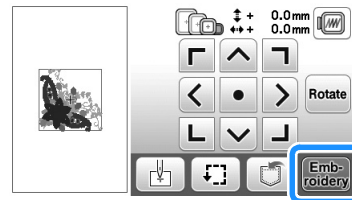

→ Embroidering screen appears.

Confirming the Pattern Position

The pattern is normally positioned in the center of the embroidery frame. If the pattern needs to be repositioned for better placement on the garment, you can check the layout before starting embroidery.

Checking the pattern position

The embroidery frame moves and shows the pattern position. Watch the frame closely to make sure the pattern will be sewn in the right place.

- 1 Press  on the embroidery settings screen.

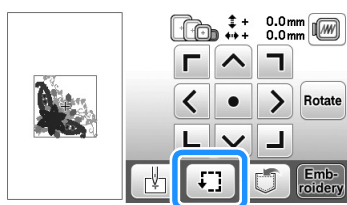

- 2 From , press the key for the position that you want to check.

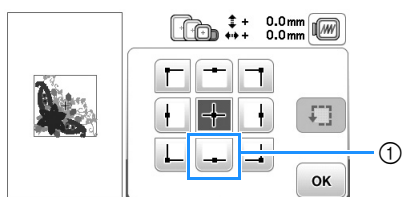

① Selected position

→ The carriage will move to the selected position on the pattern.

Memo

- To see the entire embroidering area, press . The embroidery frame moves and shows the embroidery area.

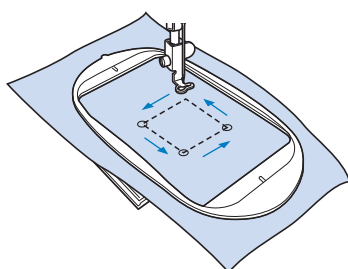

CAUTION

- Make sure the needle is up when the embroidery frame is moving. If the needle is down, it could break and result in injury.

- 3 Press .

Previewing the selected pattern

- 1 Press .

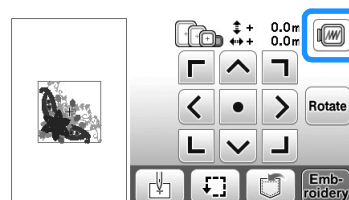



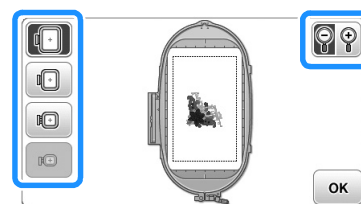

→ An image of the pattern as it will be embroidered appears.

- 2 Press  to select the frame used in the preview.

- Frames displayed in light gray cannot be selected.
- Press  to enlarge the image of the pattern.
- The pattern can be sewn as it appears in the following display.



■ Frame sizes displayed on screen

Display	Frame type and embroidering area
	Extra large embroidery frame 26 cm × 16 cm (10-1/4 inches × 6-1/4 inches)
	Large embroidery frame (sold separately with some models) 18 cm × 13 cm (7 inches × 5 inches)
	Medium embroidery frame (sold separately with some models) 10 cm × 10 cm (4 inches × 4 inches)
	Small embroidery frame (sold separately with some models) 2 cm × 6 cm (1 inch × 2-1/2 inches)

- 3 Press  to return to the original screen.

Embroidering

After the preparations are done, you can try embroidering. This section describes the steps for embroidering and appliquéing.

Embroidering a pattern

Embroidery patterns are embroidered with a change of thread after each color.

- 1 Prepare embroidery thread of the color shown on the screen.

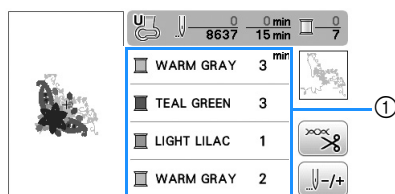

- 1 Embroidery color order

- The thread color number set displayed for the thread colors can be changed. Press , and then change the setting in the settings screen. For details, refer to "Changing the thread color display" on page B-37.

- 2 Set the embroidery thread, and thread the needle.

- Refer to "Threading the upper thread" on page B-19 and "Threading the needle" on page B-21.



Note

- Before using the needle threader, be sure to lower the presser foot.

- 3 Pass the thread through the embroidery foot hole, and hold it lightly in your left hand.

Give the thread a little slack.

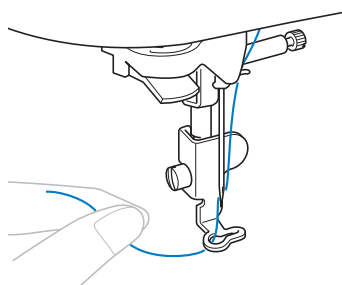

⚠ CAUTION

- If the thread is pulled too tight, the needle may break or bend.
- Do not let hands or objects hit the carriage while sewing. The pattern may misalign.

- 4 Lower the presser foot, then press the "Start/Stop" button to start embroidering. After 5-6 stitches, press the "Start/Stop" button again to stop the machine.

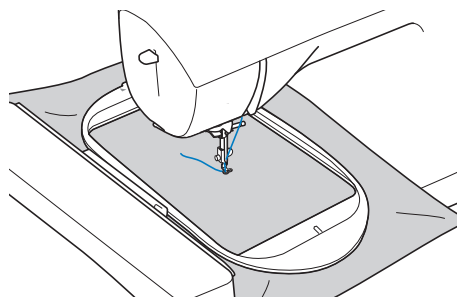

- 5 Trim the excess thread at the end of the seam. If the end of the seam is under the presser foot, raise the presser foot, then trim the excess thread.

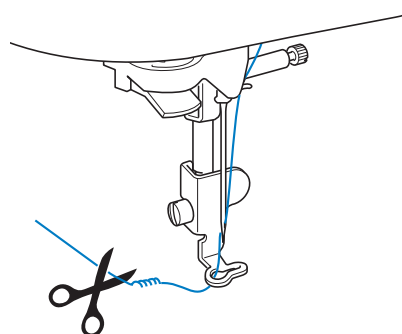

- If the thread is left at the beginning of the stitching, it may be sewn over as you continue embroidering the pattern, making it very difficult to deal with the thread after the pattern is finished. Trim the thread at the beginning.

- 6 Press the "Start/Stop" button to start embroidering.

→ Stitching stops automatically with reinforcement after one color has been completed. When automatic thread cutting is set, the thread is cut.

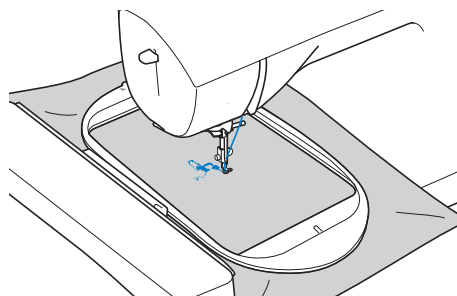

- 7 Remove the thread for the first color from the machine. Thread the machine with the next color.

8 Repeat the same steps for embroidering the remaining colors.

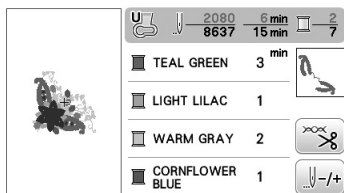

→ When the last color is sewn, the message informing that the embroidering is finished will appear on the display. Press **OK**, and the display will return to the initial screen.

Memo

- For the automatic thread cutting setting, refer to “Using the automatic thread cutting function (END COLOR TRIM)” in the “Embroidering” section.

9 Cut the excess thread jumps within the color.

Changing the thread color display

You can display the name of the thread colors or embroidery thread number.

Memo

- Colors on the screen may vary slightly from actual spool colors.

1 Press **Menu.**

2 Use **Left or **Right** on operation panel to display the thread color selections.**

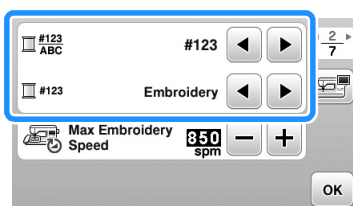

3 Use **Left or **Right** to select the name of the thread colors or the embroidery thread number.**

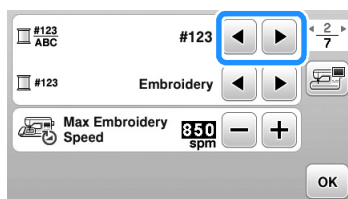

Thread color name

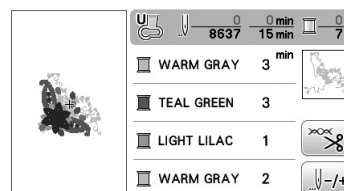

Thread number

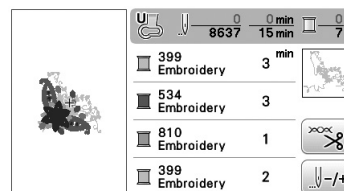

4 When the thread number “#123” is displayed, use **Left or **Right** to select from six embroidery thread brands pictured below.**

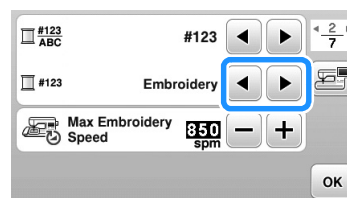

Embroidery (polyester thread)

- 399 Embroidery
- 534 Embroidery
- 810 Embroidery
- 399 Embroidery

Country (cotton thread)*

- 706 Country
- 483 Country
- 133 Country
- 706 Country

Madeira Poly (polyester thread)

- 1860 Madeira Poly
- 1879 Madeira Poly
- 1911 Madeira Poly
- 1960 Madeira Poly

Madeira Rayon

- 1085 Madeira Rayon
- 1298 Madeira Rayon
- 1031 Madeira Rayon
- 1085 Madeira Rayon

Sulky

- 1218 Sulky
- 1503 Sulky
- 1121 Sulky
- 1218 Sulky

Robison-Anton (polyester thread)

- 9126 R-A Poly
- 5751 R-A Poly
- 9016 R-A Poly
- 9126 R-A Poly

* Depending on the country or area, cotton-like polyester thread is sold.

5 Press **OK.**

B STARTING TO EMBROIDER



Embroidering

This section provides instruction to embroider designs with this machine.
Page number starts with “E” in this section.

The screen display and machine illustration may vary slightly, depending on the countries or regions.

Chapter1 EMBROIDERY E-2

Chapter 1 EMBROIDERY

Selecting Patterns

Prepare the machine for embroidery according to the instructions on “STARTING TO EMBROIDER” of “Basic operations”.

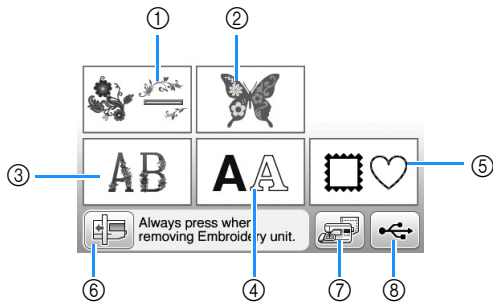

- ① Embroidery patterns
- ② Brother “Exclusives”
- ③ Floral alphabet patterns
- ④ Character patterns
- ⑤ Frame patterns
- ⑥ Press this key to position the embroidery unit for storage.
- ⑦ Patterns saved in the machine’s memory (page E-33)
- ⑧ Patterns saved in USB flash drive (page E-34)

Memo

- See included “Embroidery Design Guide” for more information on each category’s selection screen.

Selecting embroidery patterns/Brother “Exclusives”/floral alphabet patterns

- 1 Select the category of the pattern.

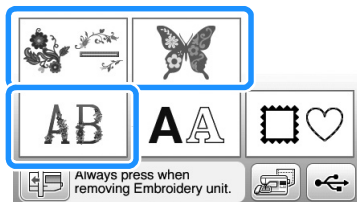

- 2 Press the key of the desired pattern.

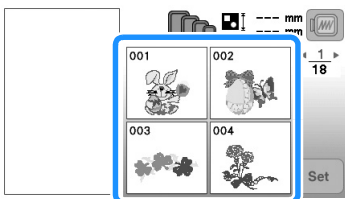

→ The pattern is displayed in the left part of the screen.

- 3 Press **Set**.

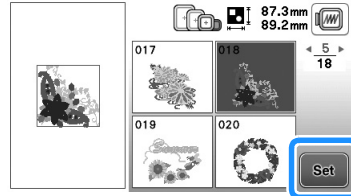

→ The pattern selected is outlined in red.

- 4 Proceed to “Editing Patterns” on page E-5 to edit the pattern.

Selecting character patterns

- **Example:** Entering “We Fly”.

- 1 Press **AA**.

- 2 Press the key of the font you want to embroider.

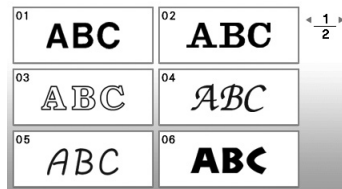

- 3 Press **▶** to display “W” on the screen, and then enter “W”.

- The number located on the left side of the text input box at the top of the screen indicates the current line number.

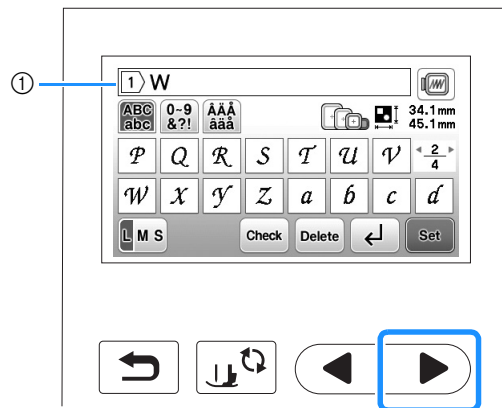

- ① Current line number

- 4 Press **▶** to display “e” on the screen, and then enter “e”.

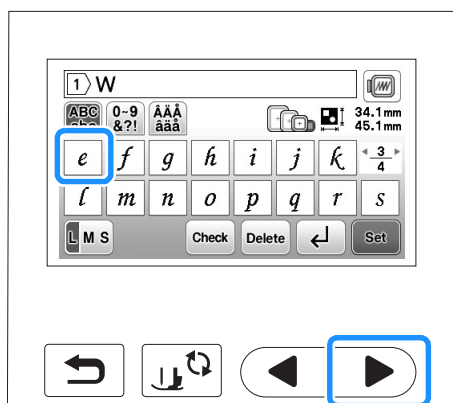

- After selecting a character if you would like to change the character size press **LMS**. The size changes each time you press the key, from large to medium to small.
- If you make a mistake, press **Delete** to erase the mistake.
- To check all entered characters, for example, when there are multiple text lines, press **Check**.
- If you want to add multiple lines, refer to “Entering a line feed” on page E-4.

Memo

- If you continue adding characters after changing the size, the new characters will be entered in the new size.

- 5 Press **▶**, and then press **⏏** to enter a space.

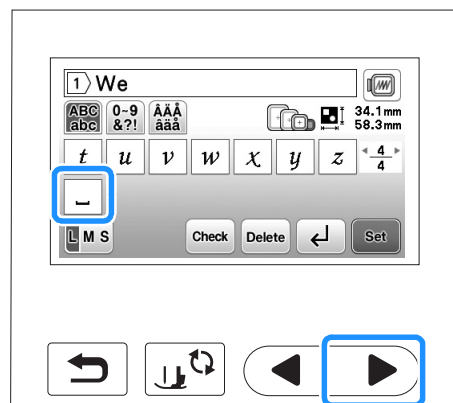

- 6 Press **▶**, and then enter “F”.

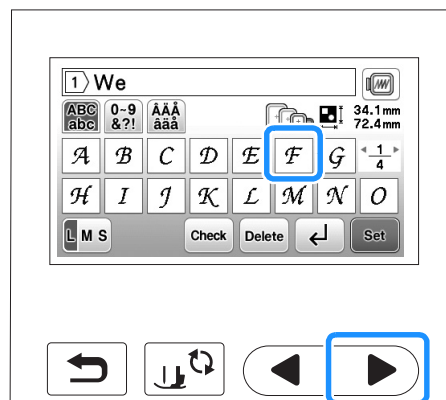

- 7 Press **▶** to display “l” and “y”, and enter them.

- 8 Press **Set**.

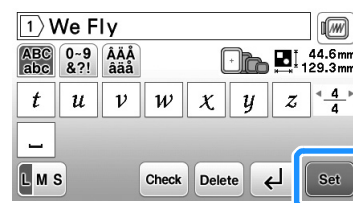

→ The editing screen is displayed.

- 9 Proceed to “Editing Patterns” on page E-5 to edit the pattern.

- For details on editing characters, refer to “Editing Character Patterns” on page E-9.
- To return to the previous screen to select another pattern, press **↶**.

■ Entering a line feed

Using the line feed key, multiple lines of text can be entered. Each line becomes a group, each of which can be edited one at a time.

- **Example:** Entering “High” in the second line of the following screen

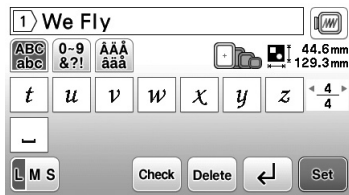

- 1 Press .

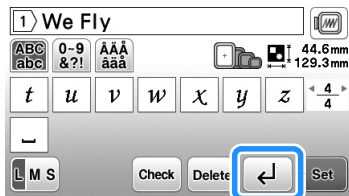

- 2 Enter “High”.



- 3 Press .

→ The editing screen is displayed.

Memo

- To change the text before the line feed in the text input screen, press , also to delete any text after the line feed.
- When is pressed to change the character size, the size of characters in the displayed line of text is changed. To change the size of characters in a different line of text, press to erase text until the line to be changed appears, or resize the pattern in the pattern editing screen.
- We recommend pressing before entering a line feed in order to preview the pattern.

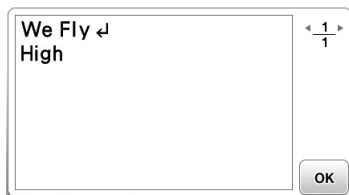

Selecting frame patterns

- 1 Press .

- 2 Press the key of the frame shape you want to embroidery.

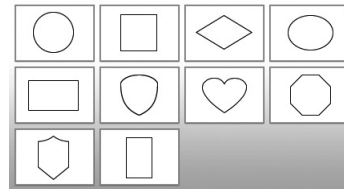

- 3 Press the key of the frame pattern you want to embroidery.

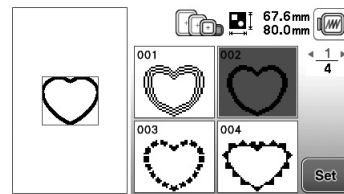

- If you make a mistake selecting the pattern, press the key of the pattern you want to embroider.
→ The selected pattern is displayed on the screen.

- 4 Press .

→ The editing screen is displayed.

- 5 Proceed to “Editing Patterns” on page E-5 to edit the pattern.

- To return to the previous screen to select another pattern, press .

Editing Patterns

When a pattern is selected in the pattern selection screen and **Set** is pressed, the pattern editing screen appears. To finish editing, press **Edit End** to continue to the embroidery settings screen.

■ Pattern editing screen

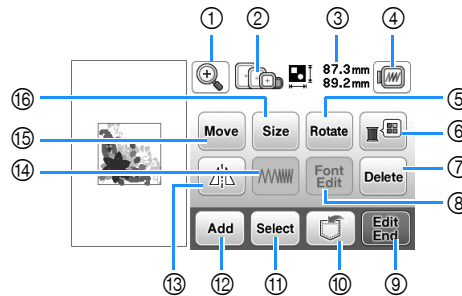

Memo

- If a key display is light gray, you cannot use that function with the selected pattern.

CAUTION

- When you have revised the pattern, check the display of available embroidery frames and use an appropriate frame. If you use an embroidery frame not displayed as available for use, the presser foot may strike the frame and possibly cause injury.

No.	Display	Key Name	Explanation	Page
①		Magnify key	Press this key to magnify the pattern in the screen.	E-8
②		Embroidery frame	Shows the embroidery frames that can be used.	-
③		Pattern size	Shows the size of the entire combined pattern.	-
④		Preview key	Press this key to show sewn image. For details, refer to “Previewing the selected pattern” in the “Basic operations” section.	-
⑤		Rotate key	Press this key to rotate the pattern. You can rotate a pattern one degree, ten degrees or ninety degrees at a time.	E-6
⑥		Thread palette key	Press this key to change the colors of the displayed pattern.	E-7
⑦		Delete key	Press this key to delete the selected pattern (the pattern outlined by the red box).	E-7
⑧		Font edit key	Press this key to display the font editing screen. For details, refer to “Editing All Patterns”.	E-9
⑨		Edit End key	Press this key to call up the frame layout screen. For details, refer to “Editing Character Patterns”.	E-15
⑩		Memory key	Press this key to save patterns to the machine's memory or USB flash drive.	E-32
⑪		Pattern select key	When a combined pattern is selected, use these keys to select a part of the pattern to edit.	E-14
⑫		Add key	Press this key to add another embroidery pattern to currently displayed pattern.	E-13
⑬		Horizontal mirror image key	Press this key to make a horizontal mirror image of the selected pattern.	E-7
⑭		Thread density key	Press this key to change thread density for some alphabet character and frame patterns.	E-7
⑮		Move key	Press these keys to move the pattern.	E-6
⑯		Size key	Press this key to change the size of the pattern. Patterns can be enlarged or reduced.	E-6

Moving the pattern

1 Press **Move**.

2 Use  to move the pattern in the direction shown by the arrow.

- Press  to center the pattern.

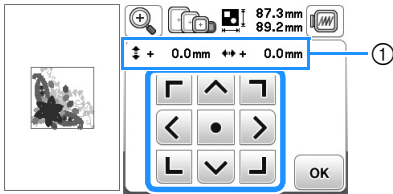

① Distance from the center

Memo

- The pattern can also be moved by dragging it.
- Patterns cannot be moved in screens where  does not appear.







3 Press **OK** to return to the original screen.

Changing the size of the pattern

1 Press **Size**.

2 Select the direction in which to change the size.

- Pressing each key to change shape of the pattern as follows.

- : Enlarge the pattern proportionately.
- : Shrink the pattern proportionately.
- : Stretch the pattern horizontally.
- : Compact the pattern horizontally.
- : Stretch the pattern vertically.
- : Compact the pattern vertically.
- : Return the pattern to its original size.

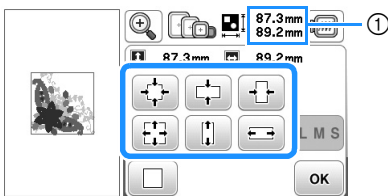

① Size of the pattern

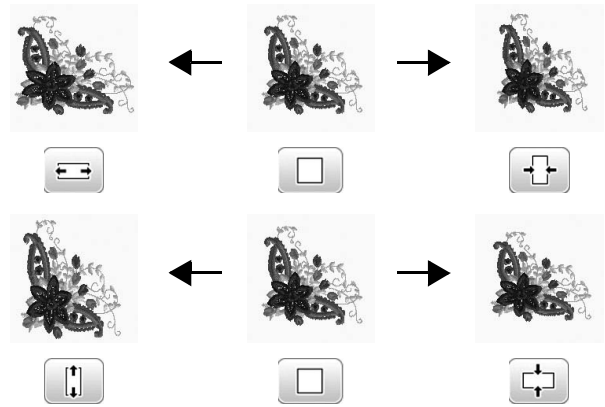

Memo







- Some patterns or characters can be enlarged more than others.
- Some patterns or characters can be enlarged to a greater degree if they are rotated 90 degrees.

3 Press **OK** to return to the original screen.

Rotating the pattern

1 Press **Rotate**.

2 Select the angle of rotation for the pattern.

- Pressing each key to rotate the pattern as follows.
 - : Rotate the pattern 90 degrees to the left.
 - : Rotate the pattern 90 degrees to the right.
 - : Rotate the pattern 10 degrees to the left.
 - : Rotate the pattern 10 degrees to the right.
 - : Rotate the pattern 1 degree to the left.
 - : Rotate the pattern 1 degree to the right.
- Press **Reset** to return the pattern to its original position.

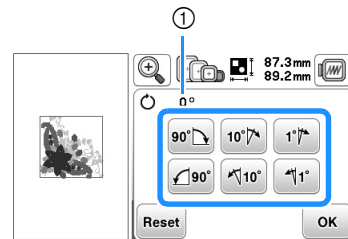



① Degree of rotation







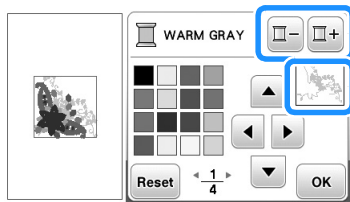

3 Press **OK** to return to the original screen.

Changing the thread color

You can change the thread color by choosing a new color from the thread colors in the machine.

- 1 In the pattern editing screen, press .
- The thread color palette screen displays.
- 2 Press  or  to select the color you want to change.



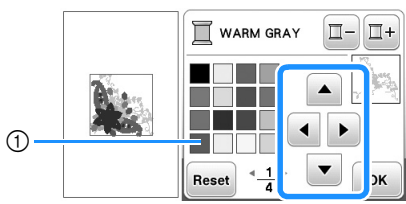

- 3 Press , , , or  or touch the color on the color palette to choose a new color.
 - To return to the original color, press , then press  after message appears. If multiple colors have been changed, this command will return all colors to their original colors.



① Color palette
→ The display shows the changed colors.

- 4 Press .

Creating a horizontal mirror image

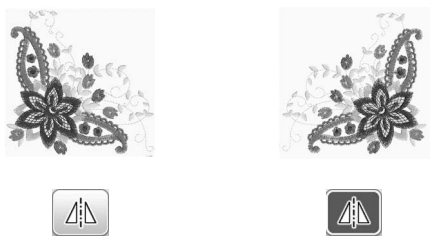

Press  so it appears as  to create a horizontal mirror image of the selected pattern. Press  again to return the pattern to normal.



Changing the density (alphabet character and frame patterns only)

The thread density for some alphabet character and frame patterns can be changed.

A setting between 80% and 120% in 5% increments can be specified.

- 1 Press .
- 2 Change the density.
 - Press  to make the pattern less dense.
 - Press  to make the pattern more dense.

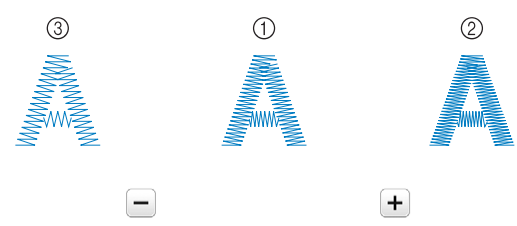
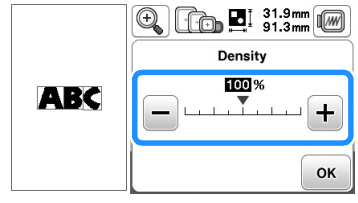

- ① Normal
 - ② Fine (stitches closer together)
 - ③ Coarse (stitches farther apart)
- The pattern density changes each time you press a button.

- 3 Press .

Deleting the pattern

Press  to delete the pattern from the screen.

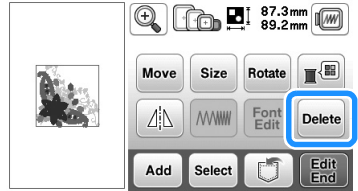

Displaying patterns in the screen magnification

1 Press .

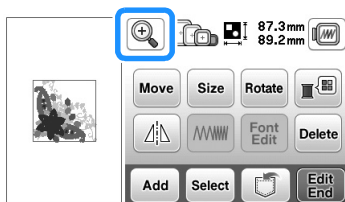

→ Magnification select screen is displayed.

2 Press desired magnification to enlarge the pattern.

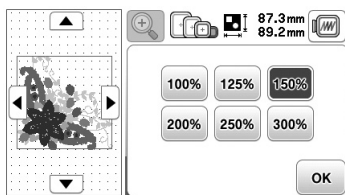



- Press  to return to the normal size.

3 Press  to return to the original screen.

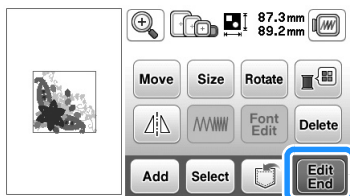

After editing

1 Press .



- To combine the pattern with other patterns, select  (page E-13).
- For more information about sewing patterns, refer to “Embroidering a pattern” in the “Basic operations” section.

Memo







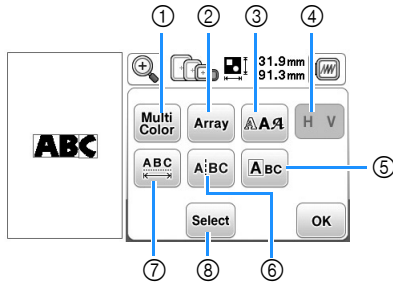

- If you want to return to the editing screen after pressing , press .

Editing Character Patterns

Font editing screen appears by pressing  on the pattern editing screen.



Font editing screen





No.	Display	Key Name	Explanation	Page
①		Multi color key	Press this key to change the color of individual characters in a pattern.	E-9
②		Array key	Press this key to change the configuration of a character pattern.	E-12
③		Font key	Press this key to change the font of the selected characters.	E-10
④		Vertical/horizontal text key	Press this key to switch between text written vertically and horizontally.	E-9
⑤		Edit character key	Press this key to edit each character separately.	E-11
⑥		Split text key	Press this key to split text between characters so that they can be edited separately.	E-10
⑦		Character spacing key	Press this key to change the spacing of character patterns.	E-10
⑧		Select key	Press this key to select a character. If the line feed key was used while entering text, single lines can be selected.	-

Changing the colors of alphabet character patterns

Combined alphabet character patterns can be sewn with each letter in a different color. If “MULTI COLOR” is set, the machine stops after each character is sewn so that the thread can be changed to a different color.

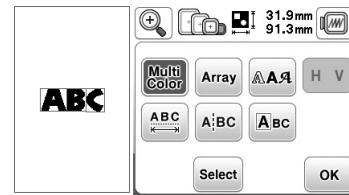
- 1 Press  so that it appears as .
 - Press the key again to return to the original setting.





- 2 Press  to return to the pattern editing screen.
 - Press  to change the colors in the sewing order (see page E-7).
- 3 After a character is sewn, change the thread color, and then sew the next character.

Switching between text written vertically and horizontally

When the Japanese font is selected, the text can be switched between being written vertically and horizontally.

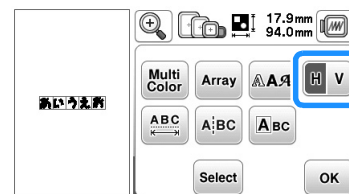
- 1 Press  to switch between text written vertically and horizontally.



- 2 Press  to return to the pattern editing screen.

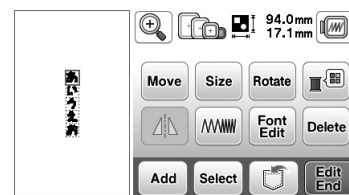

Note

- Western characters cannot be written vertically.

Changing the font of entered characters

After text has been entered, the font can be changed.

1 Press .

2 Select the font that you wish to use.

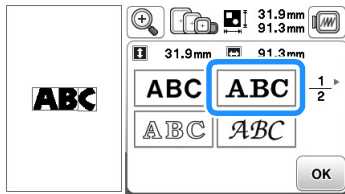

→ The text appears in the screen with the new font applied.

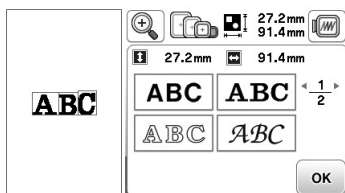



Note

- Depending on the font that was selected, it may not be possible to change the font.

Changing character spacing

1 Press .

2 Press /  to increase or decrease the character spacing.

- Press  to return the pattern to its original appearance.

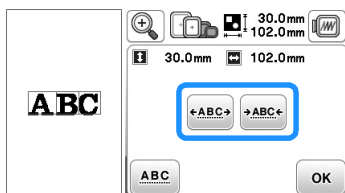

A B C ↔ ABC



3 Press  to return to the font editing screen.

Reducing character spacing

The spacing between characters can be reduced to 50% of the narrowest character in the group.



Note

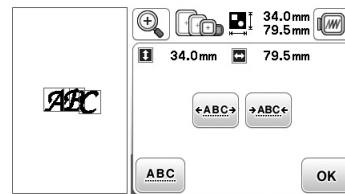
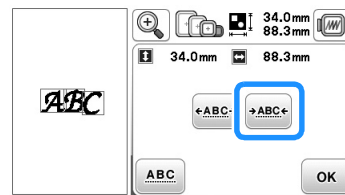

- It is not recommended to edit data and transfer to other or older version machines. Same features do not apply in other machines, so problems may occur.
- Character spacing can be reduced only when characters are arranged normally on a straight line.



Separating combined character patterns

Combined character patterns can be separated to adjust the character spacing or to separately edit the patterns after all characters have been entered.

1 Press .

2 Use /  to select where the pattern is to be separated, and then press  to separate it. For this example, the pattern will be separated between "A" and "B".

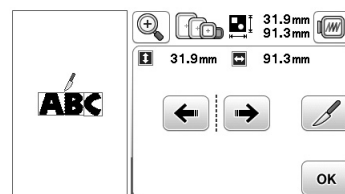

Note

- A separated character pattern cannot be combined again.

3 Press **OK** to return to the font editing screen.

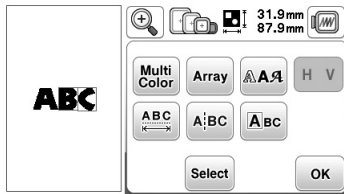

Editing single characters

Press **ABC** so that a single character can be selected for editing. The character size and font can be changed.

Changing the size

1 Press **ABC**.

2 Select the character to be resized.

- To select the character, press **←** or **→**.
- The selected character is surrounded with a red box.

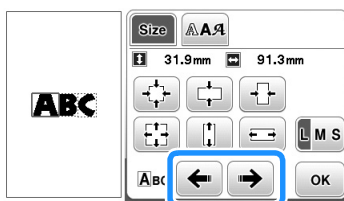

3 Select the direction in which to change the size.

- For details on the various keys, refer to the procedure in "Changing the size of the pattern" on page E-6.

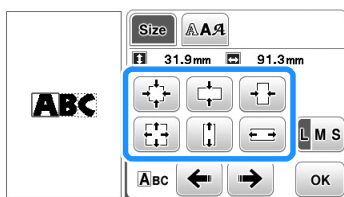

ABC → ABC

4 Press **OK** to return to the font editing screen.

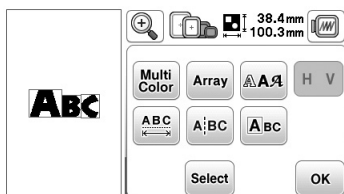

Changing the font

1 Press **ABC**.

2 Press **AA**, and then select the character whose font is to be changed.

- To select the character, press **←** or **→**.
- The selected character is surrounded with a red box.

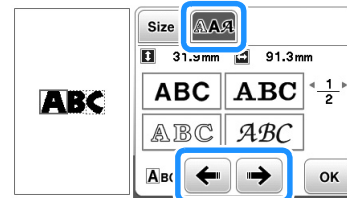

3 Select the font that you wish to use.

- The character changes to the selected font.

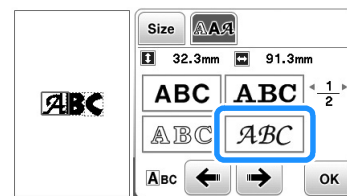

ABC → ABC

4 Press **OK** to return to the font editing screen.

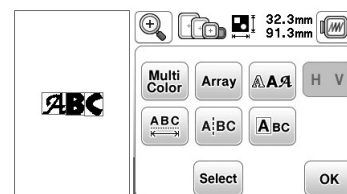

Changing the configuration of character patterns

1 Press **Array**.

2 Press the key of the layout you want to embroider.

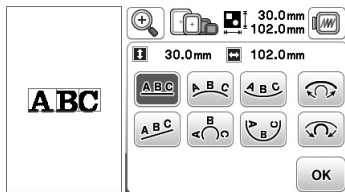

- When selecting an arc, use and to change the degree of the arc.

: Make the arc flatter.

: Make the arc rounder.

Memo

- When selecting , and change to and . You can increase or decrease the incline.

→ The display will show the selected layout.

□ Example:

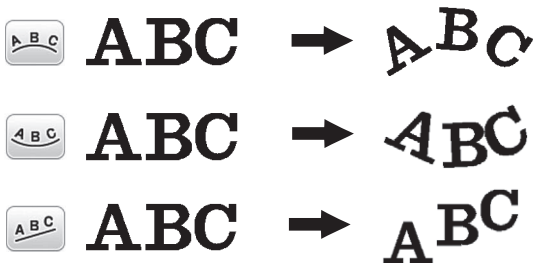

3 Press **OK** to return to the font editing screen.

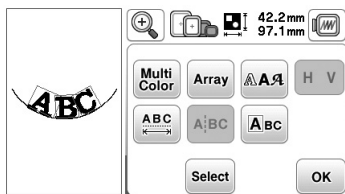

Combining Patterns

Editing combined patterns

□ **Example:** Combining alphabet characters with an embroidery pattern and editing



1 Press to select an embroidery pattern.

2 Select the following pattern and then press .

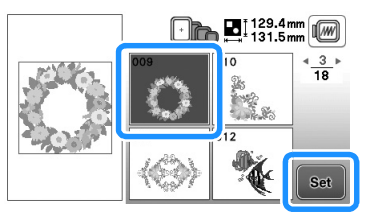

3 Press .

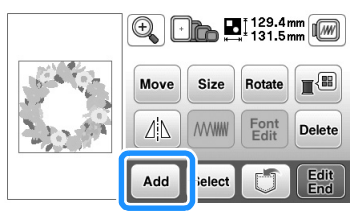

4 Press to enter the alphabet characters.

- Press to return to the previous screen.

5 Select and enter "Spring".

→ The characters you enter will be displayed in the upper part of the screen.

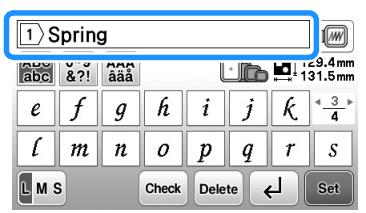

6 Press .

7 Press .

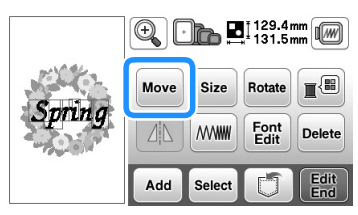

8 Press to move the characters.

- With your finger, drag the characters to move them.

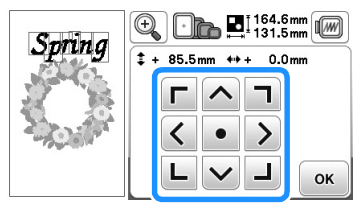

9 Press to return to the pattern editing screen.

10 Press and to change the layout of the characters. Press two times to return to the pattern editing screen.

- See page E-12 for more information about changing the layout.

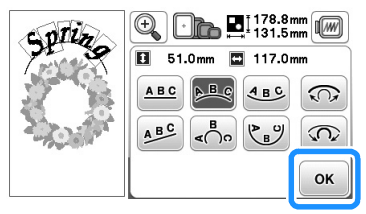

11 Press to change the color of the characters.

- The thread color palette screen displays.
- See page E-7 for more information about changing the color.

12 Press to return to the pattern editing screen.

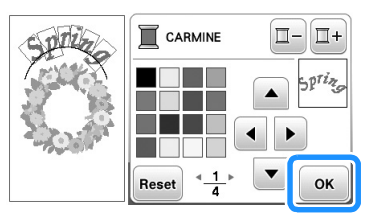

13 When all editing is finished, press **Edit End** and then **Embroidery**.

→ Embroidering screen appears.

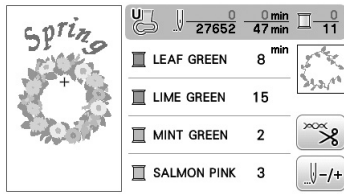

2 Embroider characters.

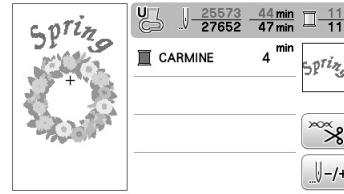

■ Selecting combined embroidery patterns

If multiple patterns have been combined, use **Select** to select the pattern to be edited. In addition, patterns can be selected by directly touching the screen with your finger.

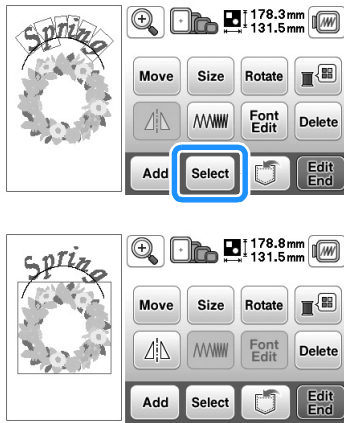

Memo

- Use **Select** to select patterns that are overlapping and cannot be selected by touching the screen.

Embroidering combined patterns

Combined patterns will be embroidered in the order they were entered. In this example, the embroidery order will be as follows:

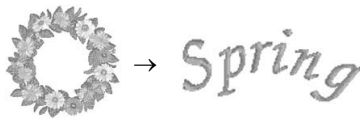

- For more information about sewing patterns, refer to “Embroidering a pattern” in the “Basic operations” section.

1 Embroider the flower pattern by following the color order on the display.

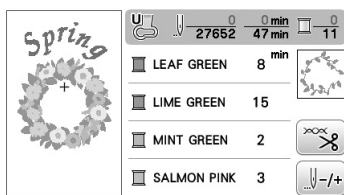

→ After the flowers are embroidered, the [+] cursor will move to the character part of the pattern.

Editing All Patterns

When **Edit End** is pressed in the editing screen, the embroidery settings screen appears. After editing the pattern, press **Embroidery** to continue to the embroidering screen.

Embroidery settings screen

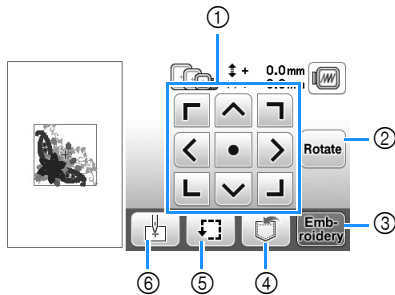

No.	Display	Key Name	Explanation	Page
①		Move key	Press these keys to move the pattern in the direction shown by the arrow. (Press the center key to return the pattern to the center of the embroidery area.)	E-15
②		Rotate key	Press this key to rotate the entire pattern.	E-15
③		Embroidery key	Press this key to enter the embroidery screen.	-
④		Memory key	Press this key to save patterns to the machine's memory or USB flash drive.	E-32
⑤		Trial key	Press this key to check the position of the pattern. The embroidery frame moves so you can check that there is enough space to sew pattern. For details, refer to "Checking the pattern position" in the "Basic operations" section.	-
⑥		Starting point key	Press this key to move the needle start position to align the needle with the pattern position.	E-15

Moving the pattern

Press to move the entire pattern.

For details, refer to "Checking the pattern position" in the "Basic operations" section.

Rotating the pattern

Press to rotate the entire pattern.

For details, refer to "Rotating the pattern" on page E-6.

Aligning the pattern and the needle

□ **Example:** Aligning the lower left side of a pattern and the needle

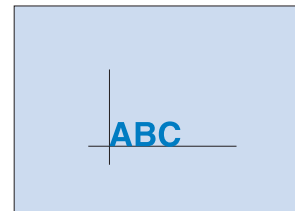

1 Mark the embroidery start position on the fabric, as shown.

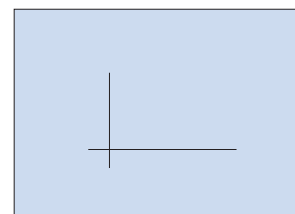

2 Press .

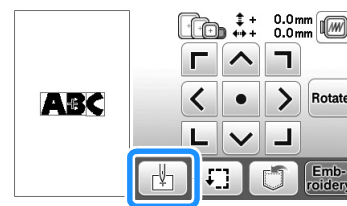

3 Press .

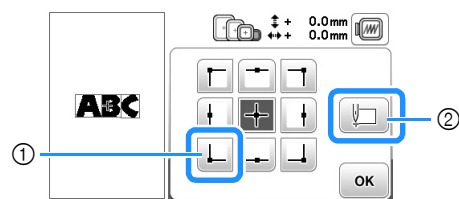

- ① Start position
- ② This key is used for aligning linked characters. (page E-16)

→ The needle position moves to the bottom left corner of the pattern (the embroidery frame moves so that the needle is positioned correctly).

4 Press .

- 5 Use  to align the needle and the mark on the fabric, and begin embroidering the pattern.

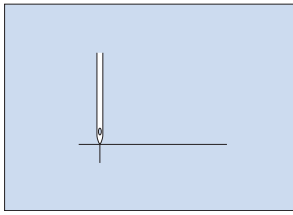

Embroidering linked characters

Follow the procedure described below to embroider linked characters in a single row when the entire pattern extends beyond the embroidery frame.

- Example: Linking “DEF” to the characters “ABC” using embroidery frame 10 cm × 10 cm (4 inches × 4 inches) (sold separately with some models)

A B C D E F

- 1 Select the character patterns for “ABC”, and then press  and .





Note

- For details on selecting character patterns, refer to “Selecting character patterns” on page E-2.

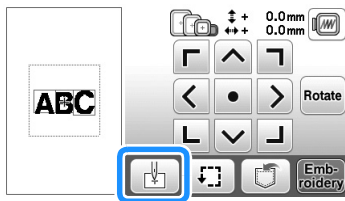
- 2 Press .



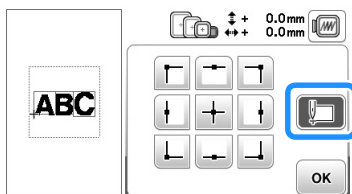

- 3 Press , and then press .



→ The needle is positioned in the lower-left corner of the pattern. The embroidery frame moves so that the needle is positioned correctly.



Note

- To cancel the starting point setting and return the starting point to the center of the pattern, press .
- Use  to select a different starting point for embroidering.

- 4 Press .

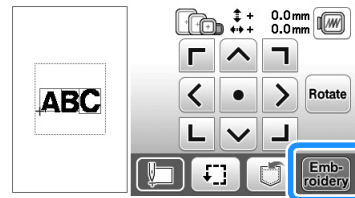

- 5 Lower the embroidery foot and then press the “Start/Stop” button to begin embroidering.

- 6 After the characters are embroidered, cut the threads, remove the embroidery frame, and then press  for “Finished embroidering”.

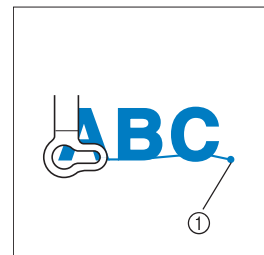

① End of the embroidering

- 7 Reposition the fabric in embroidery frame so that the right side of the letter “C” will be partially inside the embroidery frame; being careful so letters remain straight and level. Then reattach frame again so that the remaining characters (“DEF”) can be embroidered.

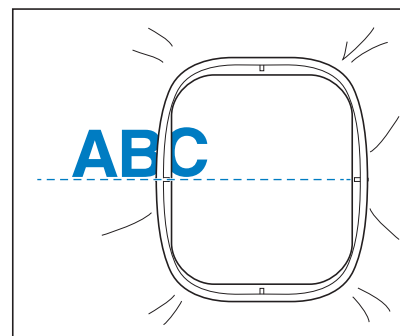

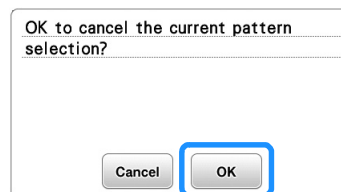

- 8 Press  and then press .



9 As in step 1, select the character patterns for “DEF”.

10 Press .

11 Press , and then press .

→ The needle is positioned in the lower-left corner of the pattern. The embroidery frame moves so that the needle is positioned correctly.

12 Use  to align the needle with the end of the embroidering for the previous pattern.

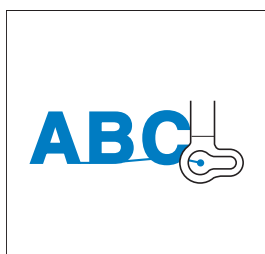
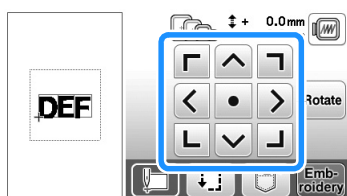

13 Press .



14 Lower the embroidery foot and press the “Start/Stop” button to begin embroidering the remaining character patterns.



Embroidery Applications

Sewing embroidery patterns which use appliqué

When the color sewing order display shows

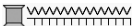
 (APPLIQUE MATERIAL),
 (APPLIQUE POSITION) or
 (APPLIQUE), follow the procedure below.



1. Creating an appliqué piece
- ↓
2. Sewing the appliqué position on the base fabric
- ↓
3. Affixing the appliqué piece to the base fabric
- ↓
4. Embroidering the remainder of the pattern

Required materials

- Fabric for the appliqué piece
- Fabric for the appliqué base
- Stabilizer material
- Craft glue
- Embroidering thread

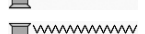

Note

- If  (APPLIQUE MATERIAL),  (APPLIQUE POSITION) or  (APPLIQUE) appear in the thread color list, the correct names and numbers of the thread colors to be used will not appear. Select the thread colors depending on those in the appliqué pattern.

1. Creating an appliqué piece

- 1 Select the appliqué pattern, and then continue to the embroidering screen.

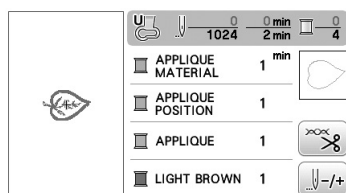

- 2 Attach stabilizer material to the wrong side of the appliqué fabric.

Hoop the fabric in the embroidery frame, and then attach the embroidery frame to the embroidery unit.

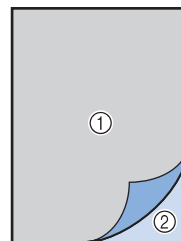

- ① Applique material (cotton, felt, etc.)
- ② Iron-on stabilizer

- 3 Thread the machine with the embroidery thread, lower the presser foot lever, and then press the "Start/Stop" button to sew the cutting line of the appliqué piece.

→ The outline of the appliqué piece is sewn, and then the machine stops.

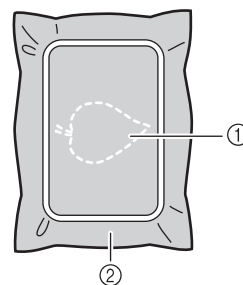

- ① Outline of applique
- ② Applique material

- 4 Remove the fabric for the appliqué piece from the embroidery frame, and then carefully cut along the sewn cutting line

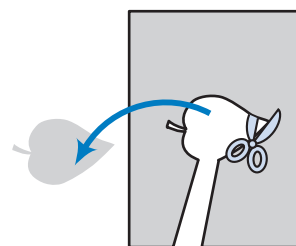

Note

- If the appliqué piece is cut out along the inside of the cutting line, it may not be correctly attached to the fabric. Therefore, carefully cut out the appliqué piece along the cutting line.
- After cutting out the appliqué piece, carefully remove the thread.

2. Sewing the appliqué position on the base fabric

- 1 Attach stabilizer material to the wrong side of the fabric for the appliqué base.
Hoop the fabric in the embroidery frame, and then attach the embroidery frame to the embroidery unit.
- 2 Thread the machine with the embroidery thread, lower the presser foot lever, and then press the "Start/Stop" button to sew the appliqué position.

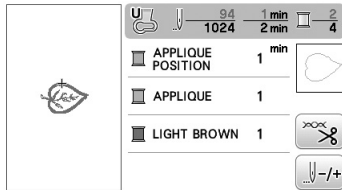

→ The position of the appliqué is sewn, and then the machine stops.

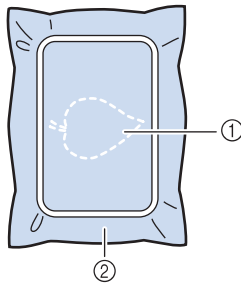

- ① Position of appliqué
- ② Base material

- 3 Remove the embroidery frame from the embroidery unit.



Note

- Do not remove the base fabric from the embroidery frame until all sewing is finished.

3. Affixing the appliqué piece to the base fabric

- 1 Lightly apply craft glue to the back of the appliqué piece, and then attach it to the base fabric within the outline of the position sewn in step 2 of "2. Sewing the appliqué position on the base fabric".

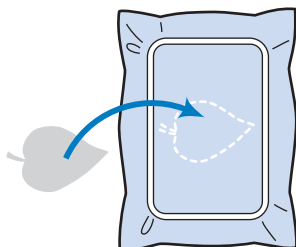

Note

- If the appliqué piece is not securely attached to the base fabric, the appliqué piece may lift off the base fabric during sewing, causing misalignment.
- If the appliqué piece cannot be attached to the base fabric with craft glue, securely baste it in place with basting stitches.
- If thin fabric is used for the appliqué piece, reinforce and secure it in place with an iron-on adhesive sheet. An iron can be used to attach the appliqué piece to the appliqué location.
- Before attaching the appliqué piece to the base fabric, do not remove the fabric from the embroidery frame.



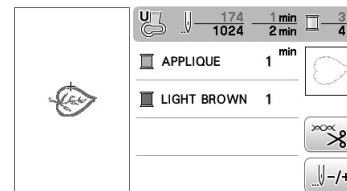

- 2 After the appliqué piece is attached, attach the embroidery frame to the machine.
Thread the machine with the embroidery thread, lower the presser foot lever, and then press the "Start/Stop" button to sew the appliqué.

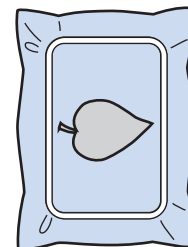

→ The appliqué piece is sewn to the base fabric, and then the machine stops.



Memo

- Depending on the pattern that is selected,  (APPLIQUE MATERIAL),  (APPLIQUE POSITION) and  (APPLIQUE) for all three steps may not appear. If  (APPLIQUE) appears as a color, embroider using thread of that color.

4. Embroidering the remainder of the pattern

- 1 Change the embroidery thread according to the thread color sewing order, and then finish embroidering the remainder of the pattern.

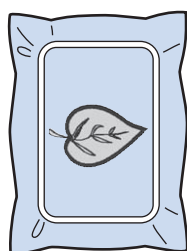
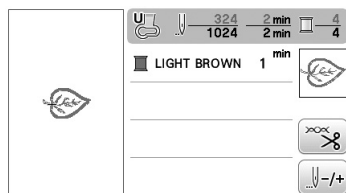

Memo

- Since glue may become attached to the presser foot, needle or needle plate, clean the glue off of the parts after finishing embroidering the appliqué pattern.
- For best results, trim all excess threads each time the thread color is changed.

Using a frame pattern to make an appliqué (1)

You can use framed patterns of the same size and shape to create an appliqué. Embroider one pattern with a straight stitch and one pattern with a satin stitch.

- 1 Select a straight stitch frame pattern. Embroider the pattern onto the appliqué material, then cut neatly around the outside of the shape.

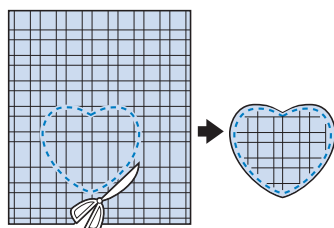
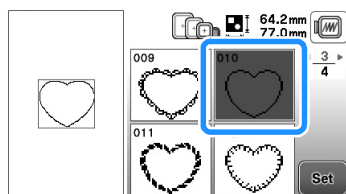

- 2 Embroider the same pattern from step 1 onto the base fabric.

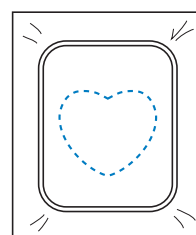

- 3 Apply a thin layer of fabric glue or a temporary spray adhesive to the rear of the appliqué created in step 1. Attach the appliqué to the base fabric matching the shapes.

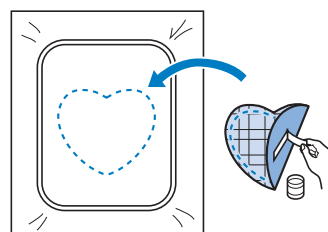

- 4 Select the satin stitch frame pattern of the same shape as the appliqué. Embroider over the appliqué and base fabric from step 3 to create the appliqué.

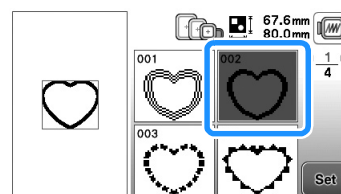

Note

- If you change the size or position of the patterns when selecting them, make a note of the size and location.

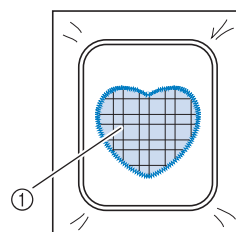

① Appliqué material

Using a frame pattern to make an appliqué (2)

This is a second method to make appliqué using embroidery patterns. You do not have to change the fabric in the embroidery frame using this method. Embroider one pattern with a straight stitch and one pattern with a satin stitch.

- 1 Select a straight stitch frame pattern, and embroider the pattern onto the base fabric.

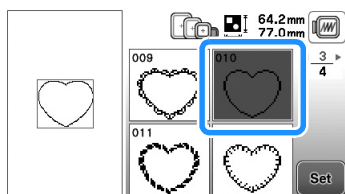

- 2 Place the appliqué fabric over the pattern embroidered in step 1.

- Be sure that the appliqué fabric completely covers the stitched line.

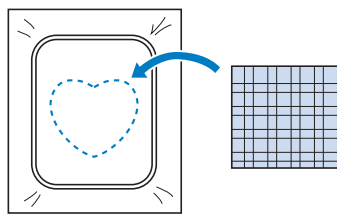

- 3 Embroider the same pattern on the appliqué fabric.

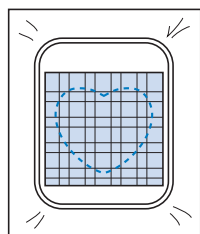

- 4 Remove the embroidery frame from the embroidery unit, and cut around the outside of the stitches.

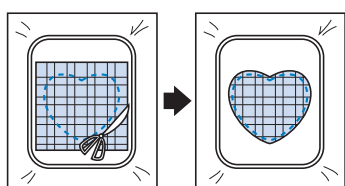

Note

- Do not remove the fabric from the embroidery frame to cut it. Also, do not pull or push on the fabric. Otherwise, the fabric may loosen in the frame.

- 5 Select the satin stitch frame pattern of the same shape as the appliqué.

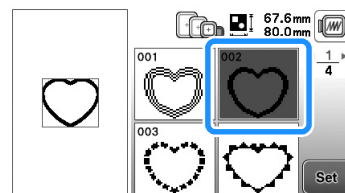

Note

- Do not change the size or position of the pattern.
- If you change the size or position of the patterns when selecting them, make a note of the size and location.

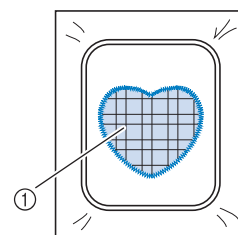

① Appliqué material

- 6 Reattach the embroidery frame to the embroidery unit, and embroider the satin stitch pattern to create an appliqué.

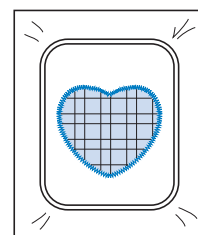

Sewing split embroidery patterns

Split embroidery patterns created with PE-DESIGN Ver.7 or later, or PE-DESIGN NEXT can be sewn. With split embroidery patterns, embroidery designs larger than the embroidery hoop are divided into multiple sections, which combine to create a single pattern after each section is sewn.

For details on creating split embroidery patterns and for more detailed sewing instructions, refer to the Instruction manual included with PE-DESIGN Ver.7 or later, or PE-DESIGN NEXT.

The following procedure describes how to read the split embroidery pattern shown below from USB flash drive and embroider it.

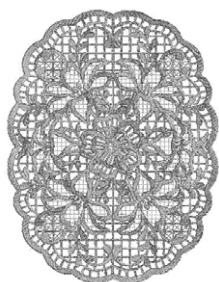

- 1 Insert the USB flash drive containing the created split embroidery pattern, and then select the split embroidery pattern to be embroidered.

- For details on recalling patterns, refer to “Recalling from USB flash drive” on page E-35.

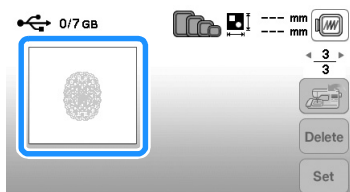

→ A screen appears so that a section of the split embroidery pattern can be selected.

- 2 Select section **Aa** to be embroidered and press **Set**.

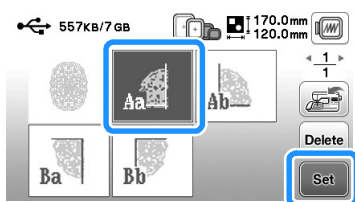

- Select the sections in alphabetical order.
- A maximum of 5 sections can be displayed in one page. If there are 6 or more sections in the pattern, press ◀ or ▶ to display the previous or next page.

- 3 If necessary, edit the pattern, and press **Edit End**.

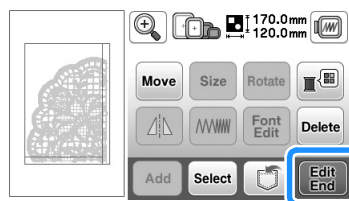

- 4 Press **Embroidery**.

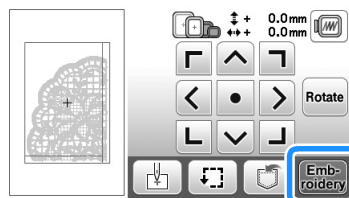

- For details on editing patterns, refer to “Editing All Patterns” on page E-15.

Memo

- Press **Rotate** to rotate the pattern.

- 5 Press the “Start/Stop” button to embroider the pattern section.

- 6 When embroidering is finished, the following screen appears. Press **OK**.

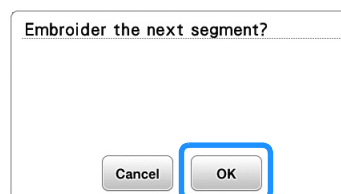

→ A screen appears so that a section of the split embroidery pattern can be selected.

- 7 Repeat steps 2 through 6 to embroider the remaining sections of the pattern.



Adjustments During the Embroidery Process



Note

- Be careful not to bump the embroidery unit carriage or the presser foot when removing or attaching the embroidery frame. Otherwise, the pattern will not embroider correctly.

If the bobbin runs out of thread

When the bobbin begins to run out of thread during embroidering, the machine will stop and the message below will appear. Press  and follow the directions below to rethread the lower threading. If very little sewing remains, you can embroider approximately 10 final stitches without rethreading the machine by pressing . The machine will stop after sewing approximately 10 stitches.

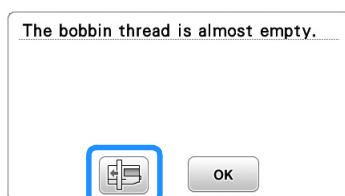

- 1 Press .



→ After the thread is automatically cut, the carriage will move.

- 2 **Unlock the frame-securing lever and remove the embroidery frame.**

- Be careful not to apply strong force to the fabric at this time. Otherwise, the fabric may loosen in the frame.

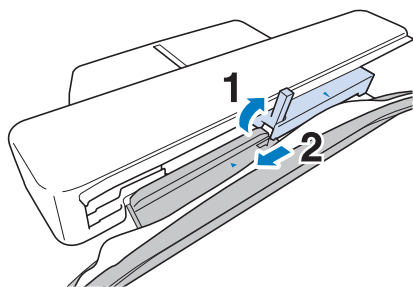

- 3 **Insert a wound bobbin into the machine.** (see “Setting the Bobbin” of “Basic operations”.)

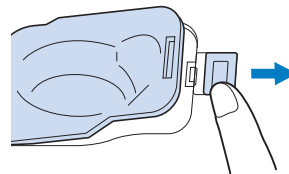

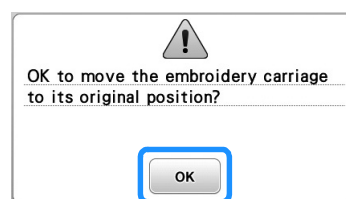

- 4 Press .







- 5 **Attach the embroidery frame.**

- 6 **To return to the area in the pattern where you stopped sewing, follow steps 3 through 6 in the next section.**

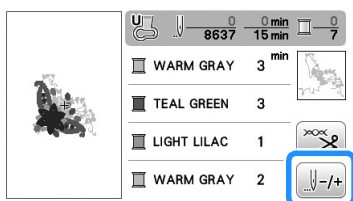
If the thread breaks during sewing





- 1 Press the "Start/Stop" button to stop the machine.
- 2 If the upper thread is broken, redo the upper threading. If the bobbin thread is broken, press  and follow the directions in steps 1 through 5 from the previous section to reset the bobbin.
- 3 Press .

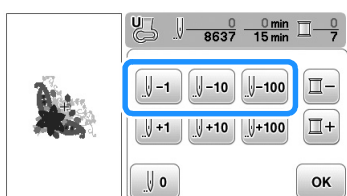



- 4 Press , , or  to move the needle back the correct number of stitches before the area where the thread broke.



Memo

- If you cannot move back to the area where the thread broke, press  to select the color and move to the beginning position of that color, then use , , or  to move ahead to slightly before where the thread broke.

- 5 Press  to return to the original screen.
- 6 Press  (Presser foot lifter button) to lower the presser foot, and press the "Start/Stop" button to continue sewing.

Restarting from the beginning

- 1 Press .

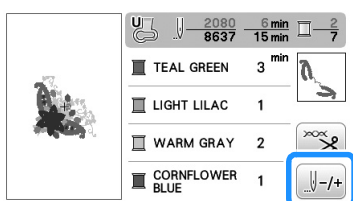

- 2 Press .

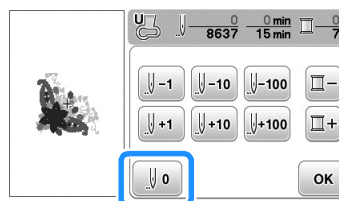

→ The embroidery frame moves, returning the needle to the pattern's beginning position.

- 3 Press  (Presser foot lifter button) to lower the presser foot and start sewing.

Resuming embroidery after turning off the power

The current color and stitch number are saved when embroidery is stopped. The next time the machine is turned on, you have the option to continue or delete the pattern.

Memo

- Even if the power goes out in the middle of embroidery, the machine returns to the point where embroidery was stopped when the machine is turned on again.

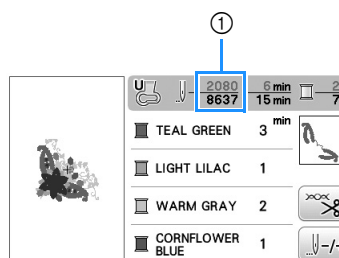

① Current stitch number when embroidery was stopped

Note

- Do not remove the embroidery unit or the memory will no longer remember your design.

- 1 Turn the main power to ON.
- 2 Follow the instructions shown on the screen and remove the embroidery frame.

3 Attach the embroidery frame and press **OK**.

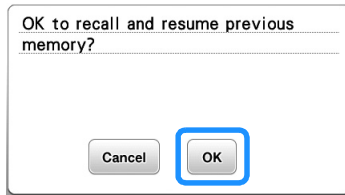

→ The previous embroidery screen displayed before the machine was turned off appears.



Memo

- If you want to start a new embroidery pattern, press **Cancel** so the pattern selection screen appears.

4 Continue embroidering.

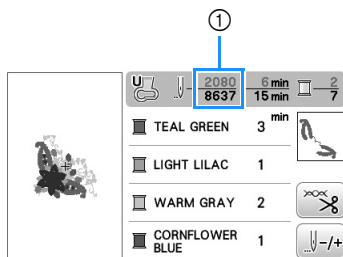

① Stitch number when embroidery is resumed.

Making Embroidery Adjustments

Adjusting thread tension

When embroidering, the thread tension should be set so that the upper thread can slightly be seen on the wrong side of the fabric.

■ Correct thread tension

The pattern can be seen from the wrong side of the fabric. If the thread tension is not set correctly, the pattern will not finish well. The fabric may pucker or the thread may break.



- ① Right side
- ② Wrong side

Follow the operations described below to adjust thread tension according to the situation.



Note

- If the thread tension setting is made extremely weak, the machine may stop during sewing. This is not the sign of a malfunction. Increase the thread tension slightly, and begin sewing again.



Memo

- If you turn the main power to OFF or select a different pattern, the thread tension will reset to the automatic setting.
- When you retrieve a saved pattern, the thread tension setting will be the same as when the pattern was saved.

■ Upper thread is too tight

The tension of the upper thread is too tight, resulting in the bobbin thread being visible from the right side of the fabric.



Note

- If the bobbin thread was incorrectly threaded, the upper thread may be too tight. In this case, refer to “Setting the Bobbin” of “Basic operations” and rethread the bobbin thread.



- ① Right side
- ② Wrong side

1 Press .

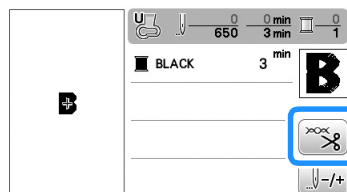

2 Press to weaken the upper thread tension. (The tension number will decrease.)

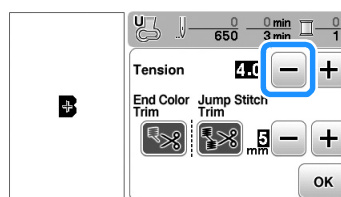

3 Press .

■ Upper thread is too loose

The tension of the upper thread is too loose, resulting in a loose upper thread, loose thread locks, or loops appearing on the right side of the fabric.



Note

- If the upper thread was incorrectly threaded, the upper thread may be too loose. In this case, refer to “Upper Threading” of “Basic operations” and rethread the upper thread.

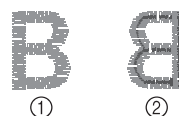

- ① Right side
- ② Wrong side

1 Press .

2 Press to tighten the upper thread tension. (The tension number will increase.)

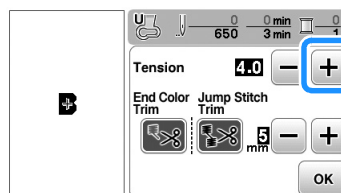

3 Press **OK**.

Note

- With “Embroidery Tension” on the setting screen, the tension of the upper thread can be adjusted for embroidering. The selected setting will be applied to all patterns. When embroidering, if the overall tension of the upper thread is too tight or too loose, adjust it from the setting screen. Press **+** to tighten the upper thread tension and press **-** to loosen the upper tension. If an individual embroidery pattern needs additional fine tuning, refer to “Adjusting thread tension” on page E-26.

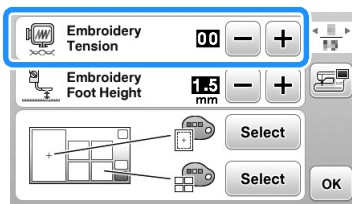

Adjusting the bobbin case (with no color on the screw)

The bobbin case (with no color on the screw) can be adjusted when bobbin tension changes are required to accommodate different bobbin threads. See “Embroidery Attractive Finishes” in the “Basic operations”.

To adjust the bobbin tension for embroidery function, using the bobbin case (with no color on the screw), turn the slotted-head screw (-) with a screwdriver (small).

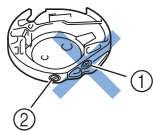

- ① Do not turn the Phillips screw (+).
- ② Adjust with a screwdriver (small).

Correct tension

Upper thread slightly appears on the wrong side of fabric.

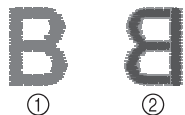

- ① Right side
- ② Wrong side

Bobbin thread is too loose

Bobbin thread appears slightly on the right side of fabric.



- ① Right side
- ② Wrong side

If this occurs, turn the slotted-head screw (-) clockwise, being careful not to over-tighten the screw, approximately 30-45 degrees to increase bobbin tension.

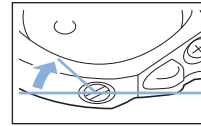

Bobbin thread is too tight

Upper thread on the right side of fabric seems to be lifting/looping and bobbin thread is not seen on the wrong side of fabric.



- ① Right side
- ② Wrong side

If this occurs, turn the slotted-head screw (-) counterclockwise, being careful not to over-loosen the screw, approximately 30-45 degrees to decrease bobbin tension.

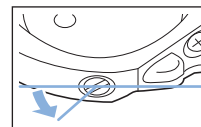

CAUTION

- When adjusting the bobbin case, be sure to remove the bobbin from the bobbin case.
- DO NOT adjust the position of the Phillips (+) screw on the bobbin case as this may result in damage to the bobbin case, rendering it unusable.
- If the slotted-head screw (-) is difficult to turn, do not use force. Turning the screw too much or providing force in either (rotational) direction may cause damage to the bobbin case. Should damage occur, the bobbin case may not maintain proper tension.

Using the automatic thread cutting function (END COLOR TRIM)

The automatic thread cutting function will cut the thread at the end of sewing each color. This function is initially turned on. To turn this function off, press key and then . This function can be turned on or off during embroidering.

1 Press .

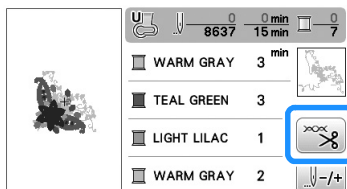

2 Press to turn off the automatic thread cutting function.

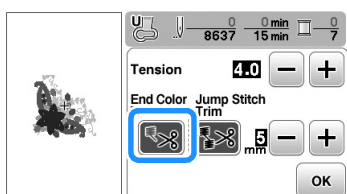

→ The key will display as .

- When one color thread is sewn, the machine will stop without cutting the thread.

3 Press to return to the original screen.

Using the Thread Trimming Function (JUMP STITCH TRIM)

The thread trimming function will automatically trim any excess thread jumps within the color. Embroidery frame (small) cannot be used. This function is initially turned on. To turn this function off, press key and then . This function can be turned on or off during embroidering.

* Your customized setting remains after turning the machine off and on.

CAUTION

- The carriage of the embroidery unit will move. Keep your hands etc. away from the carriage. Otherwise injury may result.

ABCDEF

①

① Jump stitch



Note

- When this function is turned on, use the included ball point needle 75/11 for embroidering patterns with short jump stitches such as alphabet characters. Using other needles may cause the thread to break.

■ Selecting the Length of Jump Stitch Not to Trim

When the thread trimming function is turned on, you can select the length of the jump stitch not to trim the thread. This function can be turned on or off during embroidering.

Select a setting from 5 mm to 50 mm in 5 mm increments.
* Your customized setting remains after turning the machine off and on.

Press or to select the length of jump stitch.

For example: Press to select 25 mm (1 inch) and the machine will not trim a jump stitch of 25 mm or less before moving to the next stitching.

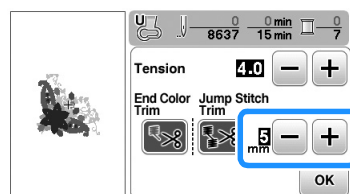

Note

- If design has many trims it is recommended to select a higher jump stitch trim setting in order to reduce the amount of excess tails on backside of fabric.
- The higher number of the jump stitch length selected, the fewer number of times the machine will trim. In this case, more jump stitches will remain on the surface of the fabric.

Adjusting the embroidery speed

1 Press to display the following screen.

2 Change the "Max Embroidery Speed" by pressing

/ .

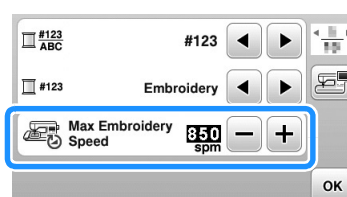



3 Press to return to the original screen.

 **Memo**

- “spm” is the number of stitches sewn in one minute.
- Decrease the embroidery speed when embroidering on thin, thick, or heavy fabrics.
- The sewing speed can be changed after an embroidery pattern has been started.
- The maximum embroidery speed setting does not change until a new setting is selected. The setting specified before the main power is set to OFF remains selected the next time that the machine is turned on.
- Decrease to a slower spm when using a special thread like a metallic thread.

Changing the “Embroidery Frame Display”

- 1 Press  to display the following screen.
- 2 In the “Embroidery Frame Display”, use  /  to change the embroidery frame display mode.

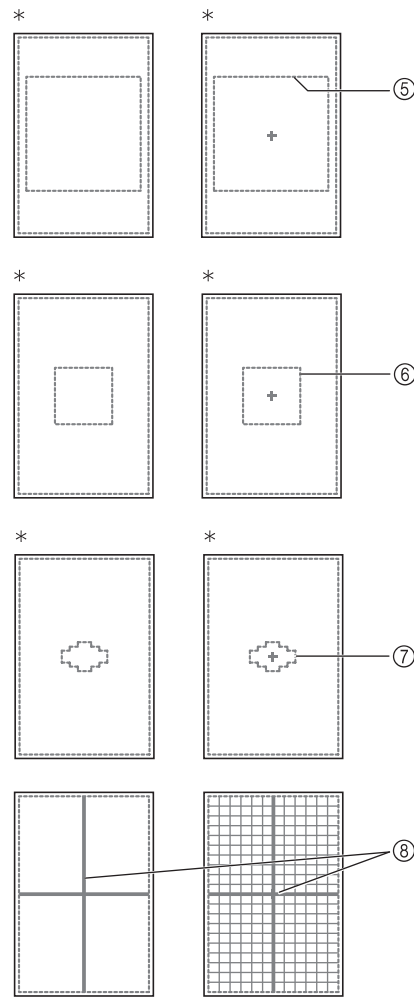
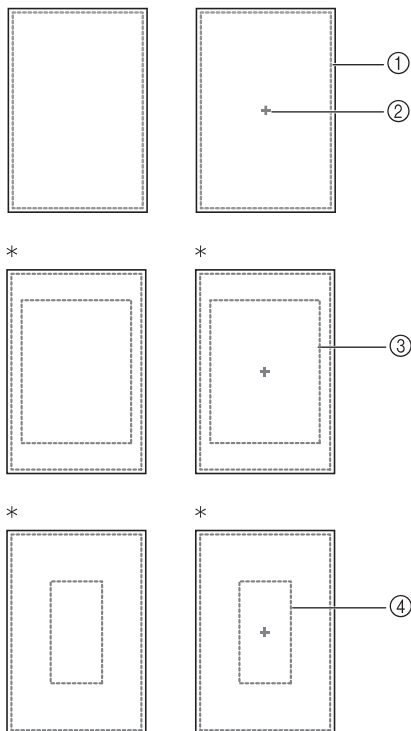
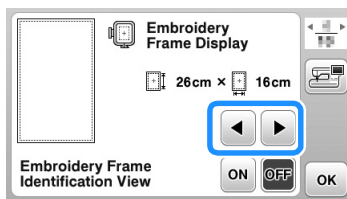

- * Sold separately with some models.
- ① Extra large frame embroidering area
26 cm×16 cm (10-1/4 inches × 6-1/4 inches)
 - ② Center mark
 - ③ Large frame embroidering area*
18 cm × 13 cm (7 inches × 5 inches)
 - ④ Embroidering area for border embroidery frame*
18 cm × 10 cm (7 inches × 4 inches)
 - ⑤ Embroidery area for quilt embroidery frame*
15 cm × 15 cm (6 inches × 6 inches)
 - ⑥ Medium frame embroidering area*
10 cm × 10 cm (4 inches × 4 inches)
 - ⑦ Embroidery area for small embroidery frame*
2 cm × 6 cm (1 inch × 2-1/2 inches)
 - ⑧ Grid lines

- 3 Press  to return to the original screen.

Selecting/displaying patterns according to the embroidery frame size

If “Embroidery Frame Identification View” in the settings screen is set to “ON”, the pattern can be edited in the screen as if that embroidery frame is attached.

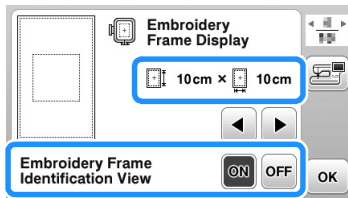

When “Embroidery Frame Identification View” is set to “OFF”.

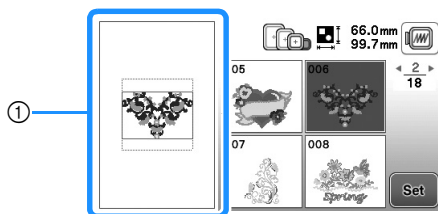

- ① The embroidering area for the extra large frame is displayed.

When “Embroidery Frame Identification View” is set to “ON”.

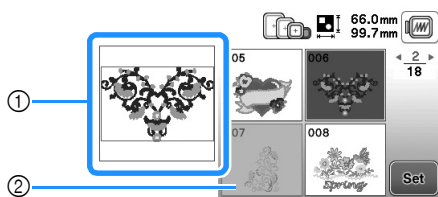

- ① The embroidering area for the selected frame is displayed.
② Patterns that will not fit in the selected frame appear shaded and cannot be selected.

Memo

- Patterns that cannot be sewn in the selected embroidery frame will not be available in the pattern selection screen.
- The pattern will be enlarged or reduced within the embroidering area for the selected embroidery frame.
- When enlarging the pattern by pressing on the editing screen, it is enlarged to 100% of the size for the selected embroidery frame.

Changing the background colors of the embroidery patterns

In the settings screen, the background colors can be changed for the embroidery pattern and pattern thumbnails. Depending on the pattern color, select the desired background color from the 66 settings available. Different background colors can be selected for the embroidery pattern and pattern thumbnails.

- ① Press to display the following screen.

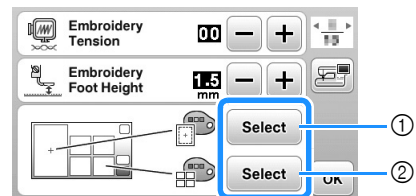

- ① Embroidery pattern background
② Pattern thumbnails background

- ② Press .

- ③ Select the background color from the 66 available settings.

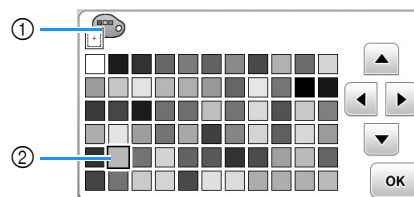

- ① Embroidery pattern background
② Selected color

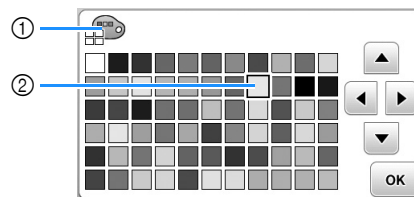

- ① Pattern thumbnails background
② Selected color

- ④ Press twice to return to the original screen.

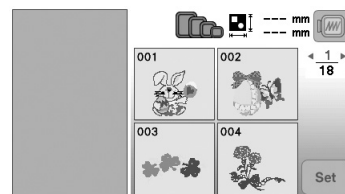

Memo



- The setting remains selected even if the machine is turned off.

Specifying the size of pattern thumbnails

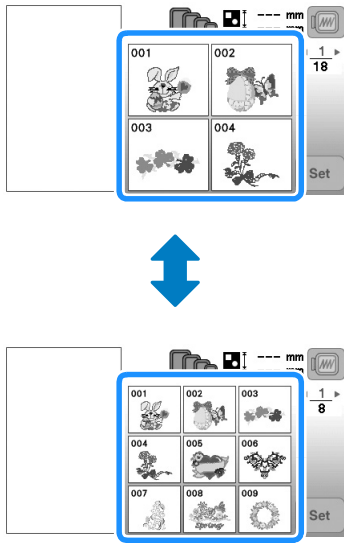
The thumbnails for selecting an embroidery pattern can be set to be displayed at the smaller size or a larger size. The larger size is 1.5 times the smaller size.



1 Press  to display the following screen.

2 Press  or  to select the desired thumbnail size.

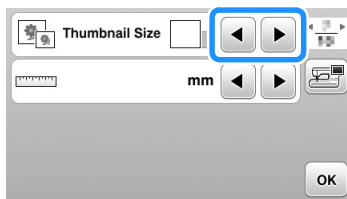

3 Press  to return to the original screen.

Using the Memory Function

Embroidery data precautions

Observe the following precautions when using embroidery data other than that created and saved in this machine.

CAUTION

- When using embroidery data other than our original patterns, the thread or needle may break when sewing with a stitch density that is too fine or when sewing three or more overlapping stitches. In that case, use one of our original data design systems to edit the embroidery data.

■ Types of embroidery data that can be used

- Only .pes, .phc, and .dst embroidery data files can be used with this machine. Using data other than that saved using our data design systems or machines may cause the embroidery machine to malfunction.

■ Types of USB media that can be used

Stitch data can be saved to or recalled from a USB flash drive of any size.



Note

- The processing speed may vary by quantity of data stored.
- Only a USB flash drive can be connected to the USB port on this machine.
- The access lamp will begin blinking after inserting USB flash drive, and it will take about 5 to 6 seconds to recognize the drive. (Time will differ depending on the USB flash drive).
- For additional information, refer to the instruction manual included with the USB flash drive that you have purchased.



Memo

- To create file folders, use a computer.

■ Precautions on using the computer to create and save data

- If the name of the embroidery data file/folder cannot be identified, for example, because the name contains special characters, the file/folder is not displayed. If this occurs, change the name of the file/folder. We recommend using the 26 letters of the alphabet (uppercase and lowercase), the numbers 0 through 9, "-", and "_".
- If embroidery data larger than 26 cm × 16 cm (approx. 10-1/4 inches × 6-1/4 inches) is selected, the pattern will be displayed rotated by 90 degrees when it is read out. Even after being rotated 90 degrees, embroidery data larger than 26 cm × 16 cm (approx. 10-1/4 inches × 6-1/4 inches) cannot be used. (All designs must be within the 26 cm × 16 cm (approx. 10-1/4 inches × 6-1/4 inches) design field size.)
- .pes files saved with the number of stitches or the number of colors exceeding the specified limits cannot be displayed. The combined design can not exceed a maximum number of 200,000 stitches or a maximum number of 125 color changes (Above numbers are approximate, depending on the overall size of the design). Use one of our design software programs to edit the embroidery pattern so that it meets these specifications.
- Embroidery data stored in a folder created in USB flash drive can be retrieved.
- Even if the embroidery unit is not attached, the machine will recognize embroidery data.

■ Tajima (.dst) embroidery data

- .dst data is displayed in the pattern list screen by file name (the actual image cannot be displayed). Only the first eight characters of the file name can be displayed.
- Since Tajima (.dst) data does not contain specific thread color information, it is displayed with our default thread color sequence. Check the preview and change the thread colors as desired.

Saving embroidery patterns in the machine's memory

You can save embroidery patterns that you have customized and will use often; for example, your name, patterns that have been rotated or had the size changed, patterns that have had the sewing position changed, etc. A total of about 1 MB of patterns can be saved in the machine's memory.



Note

- Do not turn the main power to OFF while the "Saving..." screen is displayed. You will lose the pattern you are saving.



Memo

- It takes a few seconds to save a pattern to the machine's memory.
- See page E-34 for information on retrieving a saved pattern.

- Press when the pattern you want to save is in the pattern editing screen or embroidery settings screen.

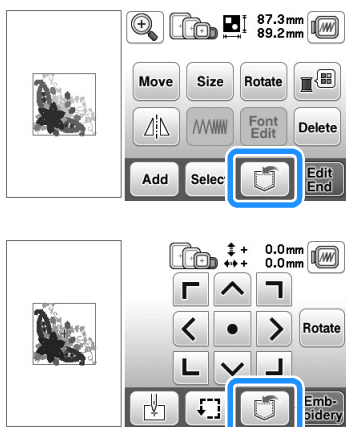

- Press .

- Press to return to the original screen without saving.



→ The "Saving..." screen is displayed. When the pattern is saved, the display returns to the original screen automatically.

If the memory is full

If the following screen appears, either the maximum number of patterns have been saved or the pattern you want to save uses a lot of memory, and the machine cannot save it. If you delete a previously saved pattern, you can save the current pattern.

- Press .

- Press to return to the original screen without saving.

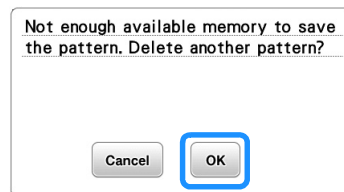

→ The machine displays the patterns currently saved.

- Select the pattern you want to delete.

- Press to move to the previous/next page.



- Press .

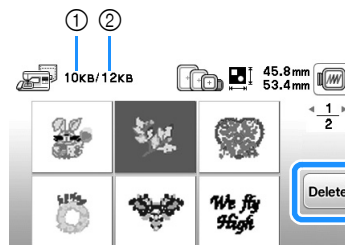

- Amount of memory used by the pattern to be deleted
- Amount of machine's memory

- Press .

- If you decide not to delete the pattern, press .



→ The "Saving..." screen displays. When the pattern is saved, the display returns to the original screen automatically.



Note

- Do not turn the main power to OFF while the "Saving..." screen is displayed. You will lose the pattern you are saving.

Memo

- If there is enough memory available after deleting the pattern, the pattern you want to save will be saved automatically. If there is not enough memory available after deleting the pattern, repeat the steps above to delete another pattern from the machine's memory.
- It takes a few seconds to save a pattern.
- See page E-34 for more information about retrieving saved patterns.

Saving embroidery patterns to USB flash drive

When sending embroidery patterns from the machine to USB flash drive, plug the USB flash drive into the machine's USB port.

Memo

- USB flash drive is commercially available, but some USB flash drive may not be usable with this machine. Please visit our website for more details.
- The USB flash drive can be inserted or removed at any time except while saving or deleting a pattern.

- 1 Press  when the pattern you want to save is in the pattern editing screen or embroidery settings screen.

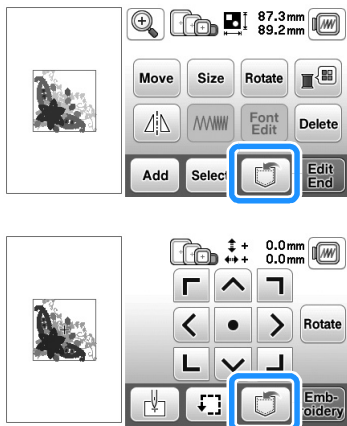

- 2 Insert the USB flash drive into the USB port on the machine.

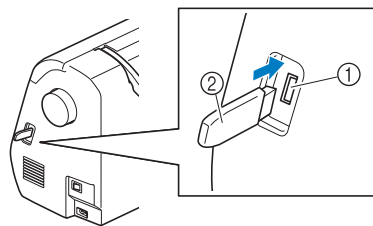

- ① USB port
- ② USB flash drive

Note

- The processing speed may vary by quantity of data.
- Do not insert anything other than USB flash drive into the USB port. Otherwise, the USB flash drive may be damaged.

- 3 Press .

- Press  to return to the original screen without saving.



→ The "Saving..." screen is displayed. When the pattern is saved, the display returns to the original screen automatically.

→ The pattern is saved in a folder labeled "bPocket".

Note

- Do not insert or remove USB flash drive while "Saving..." screen is displayed. You will lose some or all of the pattern you are saving.

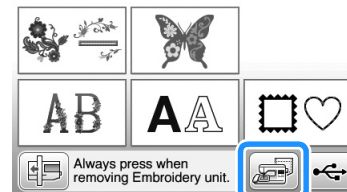

Retrieving patterns from the machine's memory

- 1 Press .



→ The machine displays the patterns currently in the memory.

- 2 Press the key of the pattern you want to retrieve.

- Press   to move to the previous/next page.
- Press  to return to the original screen.



Memo

- The selected pattern can be saved to USB flash drive directly by pressing .



3 Press .

→ Pattern editing screen is displayed.

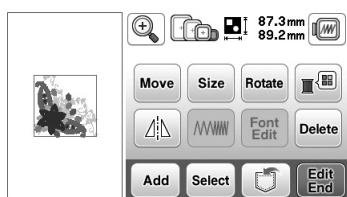

4 Adjust the pattern as desired, and then begin embroidering.

Recalling from USB flash drive

You can recall a specific embroidery pattern from either direct USB flash drive or a folder in the USB flash drive. If the pattern is in a folder, check each folder to find the embroidery pattern.

Note

- The processing speed may vary by quantity of data.

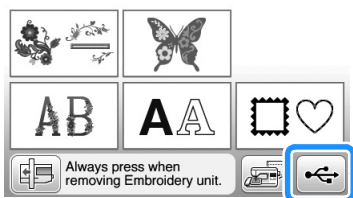

1 Insert the USB flash drive into the USB port on the machine (see page E-34).

2 Press .



→ Embroidery patterns and a folder in a top folder are displayed.

3 Select the pattern. If the stitch pattern to be retrieved is in a folder, press the key for that folder.

- Press   to move to the previous/next page.
- Press  to return to the original screen without recalling.

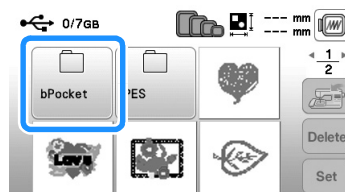

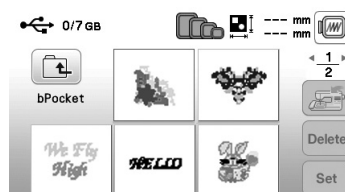

→ Stitch patterns within a folder are displayed.



- The folder name or the path to show the current folder is displayed under the folder icon. Embroidery patterns and subfolders within a folder are displayed.
- Press  to return to the previous screen.
- Use the computer to create folders. Folders cannot be created with the machine.

4 Press the key of the pattern you want to retrieve.

- Press   to move to the previous/next page.
- Press  to return to the original screen.

5 Press .



- Press  to delete the pattern. The pattern will be deleted from the USB flash drive.
- Pattern editing screen is displayed.

Memo

- The selected pattern can be saved to the machine's memory directly by pressing .



6 If necessary, edit the pattern, and press **Edit End**.

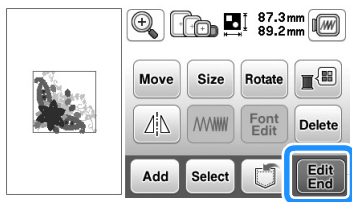

→ Embroidery settings screen is displayed.

7 Press **Embroidery**.

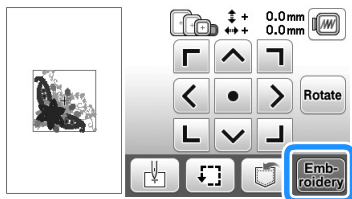

→ The embroidery screen is displayed.

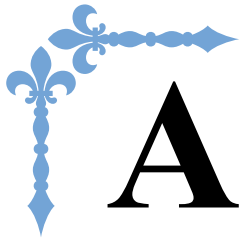

Appendix

This section provides important information for operating this machine. Please read this section to find troubleshooting tips and pointers as well as how to keep your machine in the best working order. Page number starts with "A" in this section.

Chapter1 MAINTENANCE AND TROUBLESHOOTING.....A-2

Chapter 1 MAINTENANCE AND TROUBLESHOOTING

Care and Maintenance

Restrictions on oiling

In order to prevent damaging this machine, it must not be oiled by the user.

This machine was manufactured with the necessary amount of oil applied to ensure correct operation, making periodic oiling unnecessary.

If problems occur, such as difficulty turning the handwheel or an unusual noise, immediately stop using the machine, and contact your authorized Brother dealer or the nearest Brother authorized service center.

Precautions on storing the machine

Do not store the machine in any of the locations described below, otherwise damage to the machine may result, for example, rust caused by condensation.

- Exposed to extremely high temperatures
- Exposed to extremely low temperatures
- Exposed to extreme temperature changes
- Exposed to high humidity or steam
- Near a flame, heater or air conditioner
- Outdoor or exposed to direct sunlight
- Exposed to extremely dusty or oily environments



Note

- In order to extend the life of this machine, periodically turn it on and use it. Storing this machine for an extended period of time without using it may reduce its efficiency.

Cleaning the LCD Screen

If the screen is dirty, gently wipe it with a soft, dry cloth. Do not use organic solvents or detergents.



Note

- Do not wipe the LCD screen with a damp cloth.



Memo

- Occasionally, condensation may form on the LCD screen or it may become fogged up; however, this is not a malfunction. After a while, the cloudiness will disappear.

Cleaning the machine surface

If the surface of the machine is dirty, lightly soak a cloth in neutral detergent, squeeze it out firmly, and then wipe the surface of the machine. After cleaning it once with a damp cloth, wipe it again with a dry cloth.

⚠ CAUTION

- **Unplug the power cord before cleaning the machine, otherwise injuries or an electric shock may occur.**

Cleaning the race

Sewing performance will suffer if lint and dust collects in the bobbin case, therefore, it should be cleaned regularly.

- 1 Press  (Needle position button) to raise the needle.
- 2 Turn off the machine.
- 3 Unplug the power cord from the power supply jack on the right side of the machine.

⚠ CAUTION

- **Unplug the power cord before cleaning the machine, otherwise injuries or an electric shock may occur.**

- 4 Remove the needle and embroidery foot.
 - For details, refer to "Replacing the needle" in the "Basic operations" section and "Replacing the embroidery foot" on page A-5.
- 5 Remove the embroidery unit.
- 6 Remove the needle plate cover.

■ **If there is a screw in the needle plate cover**

- 1 Use the L-shaped (or disc-shaped) screwdriver to remove the screw in the needle plate cover.

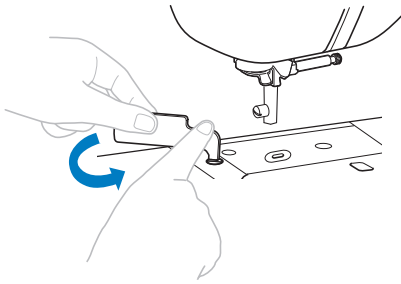

- 2 Grasp both sides of the needle plate cover, and then slide it toward you.

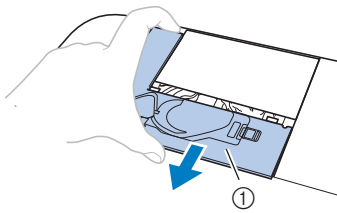

① Needle plate cover

■ **If there is no screw in the needle plate cover**

- 1 Grasp both sides of the needle plate cover, and then slide it toward you.

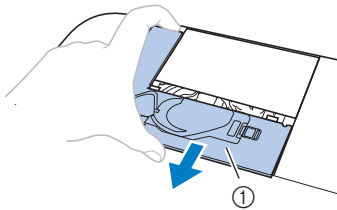

① Needle plate cover

7 Remove the bobbin case.

- 1 Grasp the bobbin case, and then pull it out.

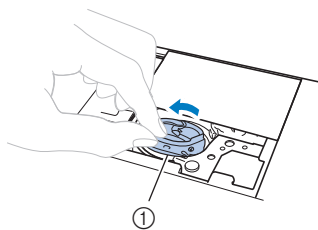

① Bobbin case

- 8 Use the cleaning brush or a vacuum cleaner to remove any lint and dust from the race and bobbin thread sensor and the surrounding area.

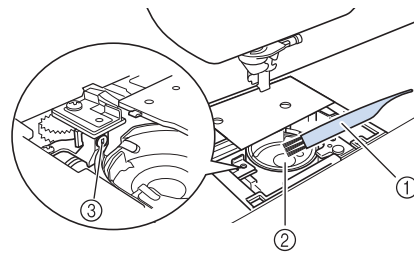

① Cleaning brush

② Race

③ Bobbin thread sensor

- Do not apply oil to the bobbin case.

- 9 Insert the bobbin case so that the ▲ mark on the bobbin case aligns with the ● mark on the machine.

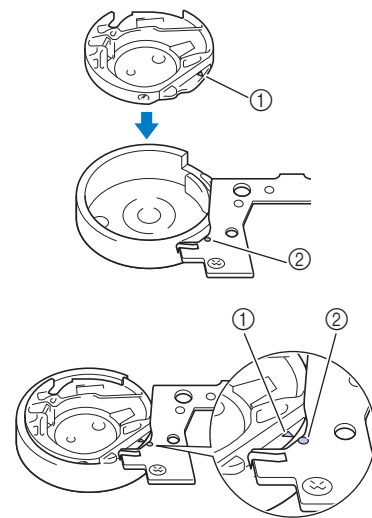

- Align the ▲ and ● marks.

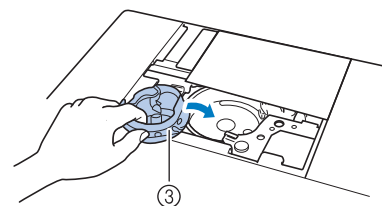

① ▲ mark

② ● mark

③ Bobbin case

- Make sure that the indicated points are aligned before installing the bobbin case.



- 10** Insert the tabs on the needle plate cover into the needle plate, and then slide the cover back on.

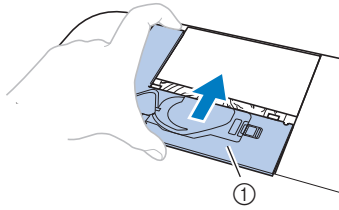

① Needle plate cover

⚠ CAUTION

- Never use a bobbin case that is scratched, otherwise the upper thread may become tangled, the needle may break or sewing performance may suffer. For a new bobbin case, contact your nearest Brother authorized service center.
- Be sure that the bobbin case is correctly installed, otherwise the needle may break.

About the maintenance message

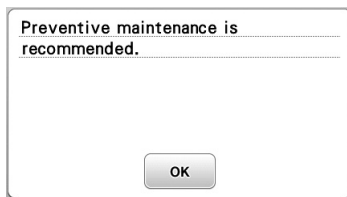

Once this message appears, it is recommended to take your machine to an authorized Brother dealer or nearest Brother authorized service center for a regular maintenance check. Although this message will disappear and the machine will continue to function once you press **OK**, the message will display several more times until the appropriate maintenance is performed.

Please take the time to arrange the maintenance your machine requires once this message appears. Such steps will help to ensure you receive continued, uninterrupted hours of machine operation for the future.

Touch panel is malfunctioning

If the screen does not respond correctly when you touch a key (the machine does not perform the operation or performs a different operation), follow the steps below to make the proper adjustments.

- 1** Holding your finger on the screen, turn the main power switch to OFF and back to ON.

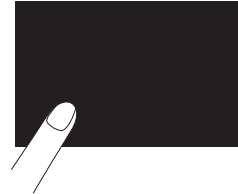

→ The touch panel adjustment screen is displayed.

- 2** Lightly touch the center of each +, in order from 1 to 5.



Note

- Do not press too hard on the screen. Otherwise, damage may result.

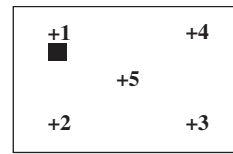

- 3** Turn the main power to OFF, then turn it back to ON.



Note

- If you finish the screen adjustment and the screen still does not respond, or if you cannot do the adjustment, contact your authorized Brother dealer.

Operation beep

Each time a key is pressed you will hear one beep. If an incorrect operation is performed you will hear two or four beeps.

- **If a key is pressed (correct operation)**
One beep sounds.
- **If an incorrect operation is performed**
Two or four beeps sound.
- **If the machine locks up, for example, because the thread is tangled**
The machine beeps for four seconds and the machine automatically stops.
Be sure to check for the cause of the error and correct it before continuing to sew.

■ Canceling the operation beep



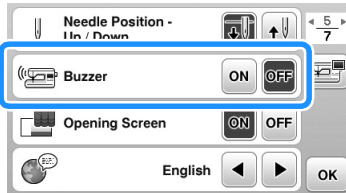

- 1 Press  to display the settings screen.
- 2 Display page 5.
- 3 Set "Buzzer" to "OFF."



Replacing the embroidery foot

⚠ CAUTION

- Only use embroidery feet designed specifically for this machine. Use of any other embroidery foot may result in injuries or damage to the machine.

- 1 Press  (Needle position button) once or twice to raise the needle.
- 2 Press .
 - When the message "OK to automatically lower the presser foot?" appears on the LCD screen, press  to continue.
 - The screen changes, and all keys and operation buttons are locked (except .

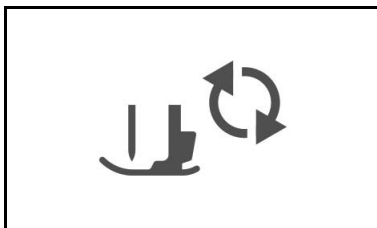

- 3 Raise the presser foot lever.

- 4 Use the included screwdriver to loosen the embroidery foot screw, and then remove the embroidery foot.

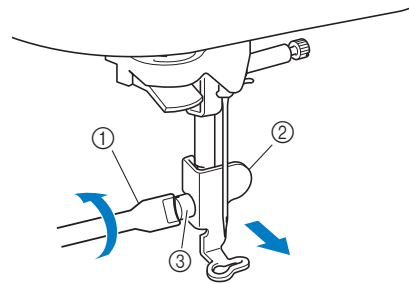

- ① Screwdriver
- ② Embroidery foot
- ③ Embroidery foot screw

- 5 Hold the embroidery foot in place with your right hand, and then use the included screwdriver to securely tighten the embroidery foot screw.

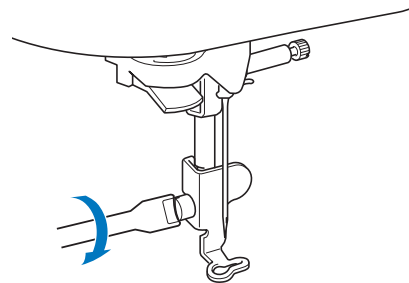

- 6 Slowly lower the presser foot lever.
- 7 Raise the presser foot lever to check that the embroidery foot is securely attached.
- 8 Press  to unlock all keys and buttons.

Troubleshooting

If the machine stops operating correctly, check the following possible problems before requesting service. You can solve most problems by yourself. If you need additional help, the Brother Solutions Center offers the latest FAQs and troubleshooting tips. Visit us at “ <http://support.brother.com/> ”.

If the problem persists, contact your Brother dealer or the nearest Brother authorized service center.

List of symptoms

■ Getting ready

Symptom	Probable Cause	Remedy	Reference
Cannot thread the needle.	Needle is not in the correct position.	Press the “Needle position” button to raise the needle.	B-4
	Needle is installed incorrectly.	Reinstall the needle correctly.	B-23
	Needle is turned, bent or the point is dull.	Replace the needle.	B-23
	Upper threading is incorrect.	Check the steps for threading the machine and rethread the machine.	B-19
	The needle threader hook is bent and does not pass through the eye of the needle.	Contact your authorized dealer or the nearest Brother authorized service center.	–
	The needle threader lever cannot be moved or returned to its original position.	Contact your authorized dealer or the nearest Brother authorized service center.	–
Cannot lower the presser foot with the presser foot lever.	Presser foot was raised using the “Presser foot lifter” button.	Press the “Presser foot lifter” button to lower the presser foot.	B-4
Bobbin thread does not wind neatly on the bobbin.	The thread is not passed through the bobbin winding thread guide correctly.	Correctly pass the thread through the bobbin winding thread guide.	B-16
	The thread that was pulled out was not wound onto the bobbin correctly.	Wind the thread that was pulled off around the bobbin 5 or 6 times clockwise.	B-16
	The empty bobbin was not set on the pin properly.	Set the empty bobbin on the pin and slowly turn the bobbin until you hear it click in place.	B-14
While winding the bobbin, the bobbin thread was wound below the bobbin winder seat.	You have not wound the bobbin thread properly. While initially winding thread on the bobbin the bobbin thread is not properly inserted into the guides.	After removing the thread wound below the bobbin winder seat, wind the bobbin correctly. Follow the drawn images on the top of the machine for guidance when threading the machine for bobbin winding.	B-14
The bobbin thread cannot be pulled up.	Bobbin is set incorrectly.	Reset the bobbin correctly.	B-17
Nothing appears in the LCD.	Main power switch is not turned on.	Turn the main power to ON.	B-8
	The plug of the power cord is not inserted into an electrical outlet.	Insert the plug of the power cord into an electrical outlet.	B-8
The LCD screen is fogged up.	Condensation has formed on the LCD screen.	After a while, the cloudiness will disappear.	–
The operation keys do not respond.	A glove is worn when the keys are pressed. The keys are pressed with a fingernail. A non-electrostatic touch pen is being used.	Directly touch the operation keys with your finger.	B-4
The operation keys do not respond, or the sensitivity is too strong.	The sensitivity of the operation keys is not set for the user.	Adjust the sensitivity of the operation keys.	B-12

Symptom	Probable Cause	Remedy	Reference
The sewing light does not come on.	The sewing light is damaged.	Contact your authorized dealer or the nearest Brother authorized service center.	–
	“Light” is set to “OFF” in the settings screen.	Change the setting to “ON”.	B-11
Embroidery unit does not operate.	Embroidery unit is not attached correctly.	Reattach the embroidery unit correctly.	B-26
	Embroidery frame was attached before the unit was initialized.	Remove the embroidery frame, and then perform the initialization process correctly.	B-27

■ While embroidering

Symptom	Probable Cause	Remedy	Reference
Machine does not operate.	“Start/Stop” button was not pushed.	Press the “Start/Stop” button.	B-4
	The bobbin winder shaft is pushed to the right.	Move the bobbin winder shaft to the left.	B-14
	There is no pattern selected.	Select a pattern.	B-34
	Presser foot is not lowered.	Lower the presser foot.	B-2
	Frame-securing lever was not lowered.	Lower frame-securing lever after installing embroidery frame.	B-33
Needle breaks.	Needle is installed incorrectly.	Reinstall the needle correctly.	B-23
	Needle clamp screw is not tightened.	Tighten the needle clamp screw.	B-23
	Needle is turned or bent.	Replace the needle.	B-23
	Using improper needle or thread for the selected fabric.	Check the information about the needle and thread to be used.	B-23
	Upper thread tension is too tight.	Adjust the thread tension.	E-26
	Spool cap is set incorrectly.	Check the method for attaching the spool cap, then reattach the spool cap.	B-14
	There are scratches around the opening in the needle plate.	Replace the needle plate, or consult your authorized Brother dealer.	–
	There are scratches around the opening in the presser foot.	Replace the presser foot, or consult your authorized Brother dealer.	A-5
	There are scratches on the bobbin case.	Replace the bobbin case, or consult your authorized Brother dealer.	A-2
	Needle is defective.	Replace the needle.	B-23
	A bobbin designed specifically for this machine is not used.	Incorrect bobbins will not work properly. Only use a bobbin designed specifically for this machine.	B-14
	Upper threading is incorrect.	Check the steps for threading the machine and rethread the machine.	B-19
	Bobbin is set incorrectly.	Reset the bobbin correctly.	B-17
Embroidery foot is attached incorrectly.	Attach the embroidery foot correctly.	A-5	
Needle breaks.	Stabilizer is not attached to fabric being embroidered.	Attach stabilizer.	B-29
	Bobbin thread is incorrectly wound.	Use a correctly wound bobbin.	B-14



Symptom	Probable Cause	Remedy	Reference
Upper thread breaks.	Machine is not threaded correctly (used the wrong spool cap, spool cap is loose, the thread did not catch the needle bar threader, etc.)	Rethread the machine correctly.	B-19
	Knotted or tangled thread is being used.	Remove any knots or tangles.	–
	Upper thread tension is too strong.	Adjust the thread tension.	E-26
	Thread is tangled.	Use scissors, etc., to cut the tangled thread and remove it from the race, etc.	A-2
	Needle is turned, bent or the point is dull.	Replace the needle.	B-23
	Needle is installed incorrectly.	Reinstall the needle correctly.	B-23
	There are scratches near the hole in the embroidery foot.	Replace the embroidery foot, or consult your authorized Brother dealer.	A-5
	There are scratches on the bobbin case.	Replace the bobbin case, or consult your authorized Brother dealer.	A-2
	Using improper needle or thread for the selected fabric.	Check the information about the needle and thread to be used.	B-23
	While embroidering, the thread became knotted or tangled.	Rethread upper and lower thread.	B-17, B-19
	A bobbin designed specifically for this machine is not used.	Incorrect bobbins will not work properly. Only use a bobbin designed specifically for this machine.	B-14
The thread is tangled on the wrong side of the fabric.	Upper threading is incorrect.	Check the steps for threading the machine and rethread the machine. Be sure that the embroidery foot is in the raised position when threading the machine so that the upper thread sets properly in the upper tension.	B-19
	Using improper needle or thread for the selected fabric.	Check the information about the needle and thread to be used.	B-23
The upper thread is too tight.	The bobbin thread is incorrectly installed.	Correctly install the bobbin thread.	B-17
Bobbin thread breaks.	Bobbin is set incorrectly.	Reset the bobbin correctly.	B-17
	Bobbin thread is incorrectly wound.	Use a correctly wound bobbin.	B-17
	There are scratches on the bobbin or it doesn't rotate properly.	Replace the bobbin.	B-14
	Thread is tangled.	Use scissors, etc. to cut the tangled thread and remove it from the race, etc.	A-2
	A bobbin designed specifically for this machine is not used.	Incorrect bobbins will not work properly. Only use a bobbin designed specifically for this machine.	B-14
Fabric puckers.	There is a mistake in the upper or bobbin threading.	Check the steps for threading the machine and rethread it correctly.	B-19
	Spool cap is set incorrectly.	Check the method for attaching the spool cap, then reattach the spool cap.	B-14
	Needle is turned, bent or the point is dull.	Replace the needle.	B-23
Skipped stitches	Machine is threaded incorrectly.	Check the steps for threading the machine and rethread it correctly.	B-19
	Needle is turned, bent or the point is dull.	Replace the needle.	B-23
	Needle is installed incorrectly.	Reinstall the needle correctly.	B-23
	The needle is worn/damaged.	Replace the needle.	B-23
	Dust or lint has collected under the needle plate.	Remove the dust or lint with the brush.	A-2

Symptom	Probable Cause	Remedy	Reference
No stitching	Needle is turned, bent or the point is dull.	Replace the needle.	B-23
	Bobbin is set incorrectly.	Reset the bobbin correctly.	B-17
	Upper threading is incorrect.	Check the steps for threading the machine and rethread the machine.	B-19
High-pitched sound while sewing	Pieces of thread are caught in the race.	Clean the race.	A-2
	Upper threading is incorrect.	Check the steps for threading the machine and rethread the machine.	B-19
	A bobbin designed specifically for this machine is not used.	Incorrect bobbins will not work properly. Only use a bobbin designed specifically for this machine.	B-14
	There are needle holes or friction scratches in the bobbin case.	Replace the bobbin case, or consult your authorized Brother dealer.	A-2
The needle contacts the needle plate.	The needle clamp screw is loose.	Firmly tighten the needle clamp screw. If the needle is bent or blunt, replace it with a new one.	B-23
	Needle is turned, bent or the point is dull.	Replace the needle.	B-23
The handwheel feels sluggish when it is turned.	Thread is tangled in the bobbin case.	Remove the tangled thread from the bobbin case. Re-install the bobbin case so it is correctly positioned.	A-2

■ After embroidering



Symptom	Probable Cause	Remedy	Reference
Thread tension is incorrect.	Upper threading is incorrect.	Check the steps for threading the machine and rethread the machine.	B-19
	Bobbin is set incorrectly.	Reset the bobbin.	B-17
	Using improper needle or thread for the selected fabric.	Check the information about the needle and thread to be used.	B-23
	Thread tension is set incorrectly.	Adjust the thread tension.	E-26
	Bobbin thread is incorrectly wound.	Use a correctly wound bobbin.	B-17
	Needle is turned, bent or the point is dull.	Replace the needle.	B-23
	A bobbin designed specifically for this machine is not used.	Incorrect bobbins will not work properly. Only use a bobbin designed specifically for this machine.	B-14
Embroidery pattern does not sew out correctly.	Thread is twisted.	Use scissors, etc., to cut the twisted thread and remove it from the bobbin case, etc.	-
	Thread tension is set incorrectly.	Adjust the thread tension.	E-26
	Fabric was not inserted into the frame correctly (fabric was loose, etc.).	If the fabric is not taut in the frame, the pattern may turn out poorly or there may be shrinkage of the pattern. Set the fabric into the frame correctly.	B-30
	Stabilizing material was not attached.	Always use stabilizing material, especially with stretch fabrics, lightweight fabrics, fabrics with a coarse weave, or fabrics that often cause pattern shrinkage. See your authorized Brother dealer for the proper stabilizer.	B-29
	There was an object placed near the machine, and the carriage or embroidery frame hit the object during sewing.	If the frame bumps something during sewing, the pattern will turn out poorly. Do not place anything in the area where the frame may bump it during sewing.	B-28

Symptom	Probable Cause	Remedy	Reference
Embroidery pattern does not sew out correctly.	Fabric outside the frame edges interferes with the sewing arm, so the embroidery unit cannot move.	Reinsert the fabric in the embroidery frame so that the excess fabric is away from the sewing arm, and rotate the pattern 180 degrees.	B-30
	Fabric is too heavy, so the embroidery unit cannot move freely.	Place a large thick book or similar object under the arm head to lightly lift the heavy side and keep it level.	–
	Fabric is hanging off the table.	If the fabric is hanging off the table during embroidery, the embroidery unit will not move freely. Place the fabric so that it does not hang off the table or hold the fabric to keep it from dragging.	B-28
	Fabric is snagged or caught on something.	Stop the machine and place the fabric so that it does not get caught or snagged.	–
	Embroidery frame was removed during sewing (for example, to reset the bobbin). The embroidery foot was bumped or moved while removing or attaching the embroidery frame, or the embroidery unit was moved.	If the embroidery foot is bumped or the embroidery unit is moved during sewing, the pattern will not turn out. Be careful when removing or reattaching the embroidery frame during sewing.	B-33
	Stabilizer is incorrectly attached, for example, it is smaller than the embroidery frame.	Attach the stabilizer correctly.	B-29
Loops appear on the surface of the fabric when embroidering.	The thread tension is incorrectly set.	Adjust the thread tension.	E-26
	The combination of the bobbin case and bobbin thread is incorrect.	Change the bobbin case or bobbin thread so that the correct combination is used.	B-28

Error messages

When erroneous operations are performed messages and advice on operation will be displayed on the LCD. Follow what is displayed. If you press or do the operation correctly while the error message is displayed, the message disappears.

	Error messages	Cause/solution
1	A malfunction occurred. Turn the machine off, then on again.	This message is displayed if some malfunction occurs. Turn the machine off, then back on again. If this message continues to appear, the machine may be malfunctioning. Please contact your authorized Brother dealer or the nearest Brother authorized service center.
2	Cannot change the configuration of the characters.	This message is displayed when there are too many characters and the curved character configuration is impossible.
3	Cannot change the font since some letters are not included to the selected font.	This message appears when the font of the embroidery character pattern is changed to one that does not include characters used in the pattern.
4	Cannot recognize the data for the selected pattern. The data may be corrupted. Please turn off the power and turn on again.	This message appears when you try to retrieve pattern data that is invalid. Since any of the following may be the cause, check the pattern data. <ul style="list-style-type: none"> The pattern data is damaged. The data that you tried to retrieve was created using another manufacturer's data design system. Turn the machine off, then on again to return it to its normal condition.
5	Check and rethread the upper thread.	This message is displayed when the upper thread is broken or not threaded correctly, and the "Start/Stop" button, etc. is pressed.
6	Data volume is too large for this pattern.	This message is displayed when the patterns you are editing take up too much memory, or if you are editing too many patterns for the memory.
7	Lower the presser foot lever.	This message is displayed when the "Presser foot lifter" button is pressed while the presser foot lever is raised/the needle is lowered.
8	Not enough available memory to save.	This message is displayed when the memory is full and the pattern cannot be saved.

	Error messages	Cause/solution
9	Not enough available memory to save the pattern. Delete another pattern?	This message is displayed when the memory is full and the pattern cannot be saved.
10	OK to recall and resume previous memory?	This message appears if the machine is turned off while embroidering, then turned on again. Press  to return the machine to the condition (pattern position and number of stitches) when it was turned off. Follow the procedure described in "If the thread breaks during sewing" on page E-24 to align the needle position and embroider the remainder of the pattern.
11	Pattern extends to the outside of embroidery frame.	This message appears when the embroidery character pattern is edited, for example, rotated, so that it no longer fits within the embroidery frame.
12	Pattern extends to the outside of embroidery frame. Add no additional characters.	This message appears when the embroidery character pattern is edited by adding a line feed so that it no longer fits within the embroidery frame.
13	Pattern extends to the outside of embroidery frame. This function cannot be used at this time.	This message appears when the embroidery character pattern is resized or switched between written vertically/horizontally so that it is too large for the embroidery frame.
14	Preventive maintenance is recommended.	This message is displayed when the machine needs to be maintained. (page A-3)
15	Selected pattern field extends to the outside of the embroidery frame.	This message appears when the selected embroidery pattern is larger than the extra large embroidery frame. Reduce the pattern size, or select a different pattern. This message appears when the selected embroidery pattern is larger than the embroidery frame selected when "Embroidery Frame Identification View" is set to "ON".
16	The bobbin thread is almost empty.	This message is displayed when the bobbin thread is running out. Follow the procedure described in "If the bobbin runs out of thread" on page E-23.
17	The bobbin winder safety device has activated. Is the thread tangled?	This message is displayed when the bobbin is being wound, and the motor locks because the thread is tangled, etc.
18	 The carriage of the embroidery unit will move. Keep your hands etc. away from the carriage.	This message appears before embroidery unit moves.
19	The pockets are full. Delete a pattern.	This message is displayed when the memory is full and a pattern must be deleted.
20	 The safety device has been activated. Is the thread tangled? Is the needle bent?	This message is displayed when the motor locks due to tangled thread or for other reasons related to thread delivery.
21	The USB media was changed. Do not change the USB media while it is being read.	This message is displayed when you attempt to select a pattern after the USB flash drive in which the pattern is saved has been changed.
22	There is a pattern included that cannot be saved to USB media. Save the pattern in the machine's memory.	Depending on the pattern, it may not be possible to save it to a USB flash drive.
23	This pattern cannot be used.	This message appears when you try to retrieve a pattern that cannot be used with this machine.
24	This USB media cannot be used.	This message is displayed when you try to use incompatible media.
25	USB media error	This message is displayed when an error occurs with the USB flash drive.
26	USB media is not loaded. Load USB media.	This message is displayed when you try to recall or save a pattern while no USB flash drive is loaded.
27	F**	If error message "F**" appears in the LCD while the machine is being used, the machine may be malfunctioning. Contact your authorized dealer or the nearest Brother authorized service center.



Specifications

■ Embroidery machine

Item	Specification
Dimensions of machine	Approx. 480 mm (W) × 300 mm (H) × 261 mm (D) (Approx. 18-7/8 inches (W) × 11-7/8 inches (H) × 10-1/4 inches (D))
Weight of machine	Approx. 8.8 kg (Approx. 19.4 lb)
Embroidering speed	70 to 850 stitches per minute
Needles	Home sewing machine needles (HA × 130)

■ Embroidery unit

Item	Specification
Dimensions of embroidery unit	Approx. 458 mm (W) × 131.8 mm (H) × 420.7 mm (D) (Approx. 18 inches (W) × 5-1/4 inches (H) × 16-1/2 inches (D))
Dimensions of machine with embroidery unit attached	Approx. 693 mm (W) × 300 mm (H) × 420.8 mm (D) (Approx. 27-1/4 inches (W) × 11-7/8 inches (H) × 16-1/2 inches (D))
Weight of embroidery unit	Approx. 3.5 kg (Approx. 7.7 lb)

* Please be aware that some specifications may change without notice.

Upgrading your machine's software using USB flash drive

You can use USB flash drive to upgrade software for your machine.
 When an upgrade program is available on our website at "<http://support.brother.com/>", please download the file(s) following the instructions on the website and steps listed below.

Note

- When using USB flash drive to upgrade the software, check that no data other than the upgrade file is saved on the USB flash drive being used before starting to upgrade.
- Upgrade file can be recalled from a USB flash drive of any size.
- Allow several seconds for machine to recognize flash drive connection.

Memo

- When the machine's software is upgraded, saved embroidery patterns will not be erased.

1 Turn on the machine while pressing and holding (Presser foot lifter button).

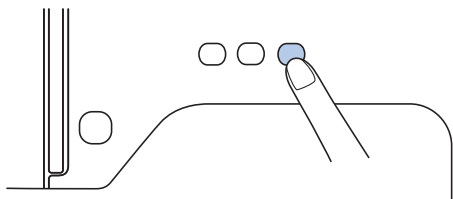

→ The following screen appears.

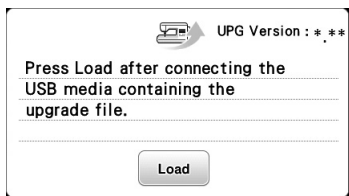

2 Insert the USB flash drive into the USB port on the machine. The media device should only contain the upgrade file.

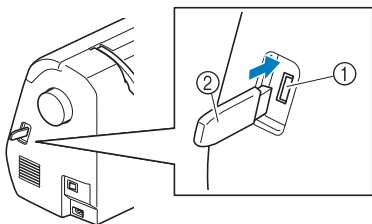

- ① USB port
- ② USB flash drive

Note

- When using USB flash drive equipped with an access indicator, the access indicator will begin flashing after the media is inserted into your machine, and may take about 5 to 6 seconds before the media is recognized. (The length of time varies depending on the USB flash drive.)

3 Press **Load**.

→ The following screen appears.

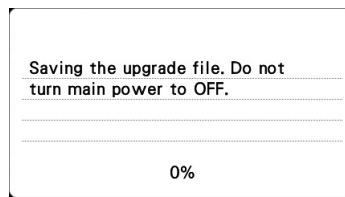

Note

- If an error occurred, a text error message will appear. At this time, turn the machine off, and then start the procedure again from step **1**.

4 When the following screen appears, upgrading is completed.

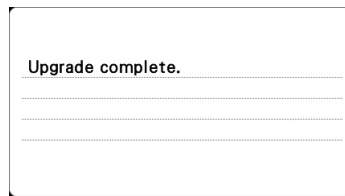

5 Remove the USB flash drive after turning off the machine, and then turn on the machine again.



Index

A

Accessories	
included accessories	B-5
optional accessories	B-6
Air vent	B-2
Aligning the position	E-15
Alphabet characters	
embroidery edit	E-2
Appliqué	
using an embroidery frame pattern	E-18
using frame pattern to make appliqué	E-20
Array key	E-12
Arrow keys	E-6, E-13

B

Back key	B-4
Beep	A-4
Bobbin	
runs out of thread	E-23
Bobbin case	B-3, B-28
Bobbin case removal	A-2
Bobbin cover	B-3, B-17
Bobbin installation	B-17
Bobbin winder	B-2
Bobbin winding	B-14
Bobbin winding thread guide	B-2, B-14
“bPocket” folder	E-34
Buzzer	A-4

C

Care	A-2
Character spacing key	E-10
Checking needle	B-23
Cleaning	
LCD screen	A-2
machine surface	A-2
race	A-2
Combining patterns	
embroidery patterns	E-13
Cut/Tension key	E-26

D

Density key	E-7
-------------	-----

E

Embroidering	B-36
Embroidering pattern	B-36
Embroidering steps	B-25
Embroidery	
automatic thread cutting function (END COLOR TRIM)	E-28
edges or corners	B-32
restarting from the beginning	E-24
resuming embroidery after turning off the power	E-24
ribbons or tape	B-32
small fabrics	B-32
thread color display	B-37
Embroidery edit	
changing the thread color	E-7
combined patterns	E-13, E-14
key functions	E-5
Embroidery frame display	E-29
Embroidery frames	
inserting fabric	B-30
removing	B-33
types	B-30

using the embroidery sheet	B-31
Embroidery key	B-4, E-8
Embroidery pattern selection	B-34
Embroidery pattern types	B-34
Embroidery patterns	
aligning the position	E-15
checking the position	B-35
combining	E-13
editing	E-5
patterns which use appliqué	E-18
retrieving	E-34, E-35
saving	E-33, E-34
selecting	E-2
using a frame pattern to make an appliqué	E-20, E-21
Embroidery sheet	B-31
Embroidery unit	B-3
attachment	B-26
carriage	B-26
removal	B-27
Error messages	A-10

F

Forward/Back key	E-24
Front view	B-2

H

Handle	B-2
Handwheel	B-2
Help key	B-4, B-13

I

Image key	B-35
Installing bobbin	B-17

K

Key functions	
embroidery settings	E-15
font edit	E-9
pattern edit	E-5

L

LCD	B-4
LCD messages	A-10
LCD operation	B-9
LCD screen	
cleaning	A-2

M

Machine surface cleaning	A-2
Main power switch	B-2
Maintenance	A-2
Manual needle threading	B-22
Mirror image key	E-7
Multi color key	E-9

N

Needle	
condition	B-23
replacement	B-23
threading	B-21
types, sizes & uses	B-23
Needle bar thread guide	B-3
Needle plate	B-3

Needle plate cover	B-3
Needle position button	B-4
Needle threader	B-21
Needle threader lever	B-2
Next page key	B-4

O

Operating procedures	B-13
Operation beep	A-4
Operation buttons	B-4
Operation keys	B-4
Operation panel	B-2, B-4
Operation problems	A-6
Optional accessories	B-6

P

Part names & functions	B-2
Pattern embroidery	B-36
Power supply jack	B-2
Power switch	B-2
Presser foot replacement	A-5
Presser foot/Needle exchange key	B-4
Previous page key	B-4

R

Race	A-2
Release button	B-27
Replacing needle	B-23
Replacing presser foot	A-5
Retrieving	
machine's memory	E-34
USB media	E-35
Rotate key	E-6

S

Saving	
machine's memory	E-33
USB media	E-34
Selecting embroidery patterns	B-34
Settings	
automatic thread cutting	E-28
display language	B-12
thread tension	E-26
Settings key	B-4
Size key	E-6
Solving operation problems	A-6
Spool net	B-15
Stabilizer	B-29
"Start/Stop" button	B-4
Starting point key	E-15

T

Thread color display	B-37
Thread cutter	B-2
Thread cutter button	B-4
Thread guide plate	B-2
Thread palette key	E-7
Thread tension	E-26
Threading	B-19
Threading needle	B-21
Threading needle manually	B-22
Top cover	B-2
Touch panel	B-4
Touch pen	B-4, B-12
Trial key	B-35
Troubleshooting	A-6

U

Upgrading	A-13
Upper thread	B-19
Upper thread spool	B-19
USB media	
recalling	E-35
saving	E-34
usable	E-32
USB port connector	B-2
for media	E-34

W

Winding bobbin	B-14
----------------------	------

Please visit us at <http://support.brother.com/> where you can get product support and answers to frequently asked questions (FAQs).

English
888-G90
Printed in Vietnam



XG8674-001