

brother®

Quick Reference Guide

Stichwortregister

Guide de référence rapide

Beknopte bedieningsgids

Guida di riferimento rapido

Guía de referencia rápida

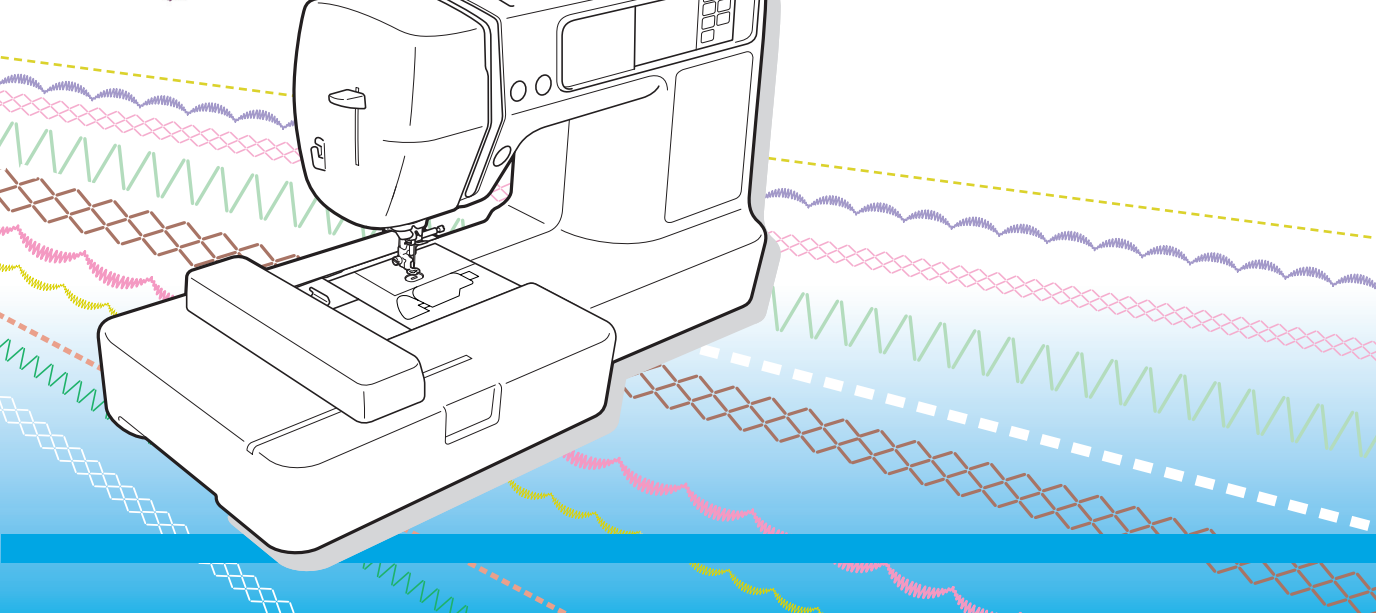
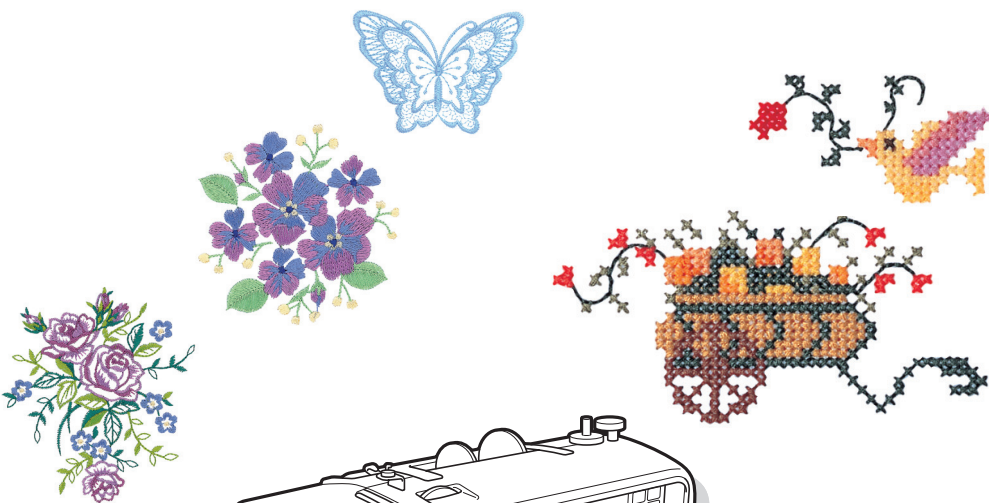
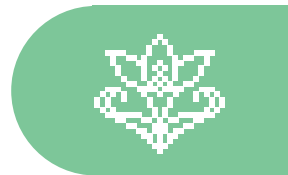
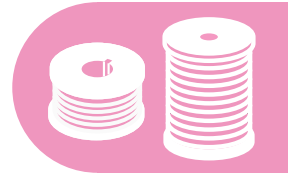

Refer to the operation manual for detailed instruction.

Also, there are differences in the keys and screens depending on the display language. In this guide, English screens are used for basic explanations.

Einzelheiten entnehmen Sie bitte der Bedienungsanleitung.

Je nachdem, welche Sprache für die Bildschirmanzeigen gewählt wurde, ergeben sich im Hinblick auf Tasten und Displaybildern eventuell Unterschiede.

Die grundlegende Bedienung der Maschine ist in dieser Anleitung am Beispiel von Displayabbildungen mit englischem Text erklärt.

Pour les instructions détaillées, voir le mode d'emploi.

Par ailleurs, il y a des différences dans les touches et les écrans en fonction de la langue d'affichage. Dans ce guide, les explications de base utilisent les écrans anglais.

Zie de gebruiksaanwijzing voor gedetailleerde instructies.

Er zijn verschillen in de toetsen en schermen afhankelijk van de ingestelde taal.

In de beschrijvingen in deze beknopte handleiding worden de Engelse schermen gebruikt.

Fare riferimento al manuale di impiego per istruzioni dettagliate.









Inoltre, ci sono differenze nei tasti e nelle schermate a seconda della lingua visualizzata.

In questa guida, le schermate in inglese sono usate per le spiegazioni basilari.

Consulte el manual de instrucciones para ver más detalles.

Además, dependiendo del idioma visualizado algunos botones y pantallas podrán ser diferentes.

En esta guía, para las explicaciones básicas se emplean pantallas en inglés.

	Machine Features Caractéristiques de l'appareil Caratteristiche della macchina	Eigenschaften der Maschine Kenmerken van de machine Características de la máquina	2
	Bobbin Winding and Setting Bobinage et réglage de la canette Avvolgimento spolina e caricamento	Afspulen des Unterfadens und Einstellung Opwinden en instellen van de spoel Bobinado y ajuste	4
	Upper Threading Enfilage supérieur Infilatura superiore	Einfädeln des Oberfadens Inrijgen van de bovendraad Hilo superior	6
	Preparing to Embroider Préparation de la broderie Preparativi per il ricamo	Vorbereitung zum Sticken Vorbereidingen voor borduren Preparativos para bordar	8
	Selecting Embroidery Patterns Sélection des motifs de broderie Selezione degli schemi di ricamo	Wählen von Stickmustern Kiezen van borduurpatronen Selección de diseños de bordados	10
	Alphanumeric Character Patterns Motifs de caractères alphanumériques Schemi dei caratteri alfanumerici	Alphanumerische Buchstabenmuster Patronen met alfanumerieke karakters Patrón de caracteres alfanumérico	13
	Frame Patterns Motifs cadres Motivi a cornicetta	Rahmenmuster Kaderpatronen Costuras de encuadre	15
	Embroidery Pattern Color Change Table Tableau de changement de couleur des motifs de broderie Tabella di cambiamento colori degli schemi di ricamo	Stickmuster-Farbtabelle Kleurwijzigingstabel voor de borduurpatronen Tabla de cambio de color para patrones de bordado	16
	Color Thread Conversion Chart Tableau de conversion des fils de couleur Tabella di conversione dei fili colorati	Stickgarn-Farbtabelle Omzettingstabel voor kleurgaren Tabla de conversión de hilos de color	20



Machine Features

Caractéristiques de l'appareil
Caratteristiche della macchina

Eigenschaften der Maschine

Kenmerken van de machine
Características de la máquina

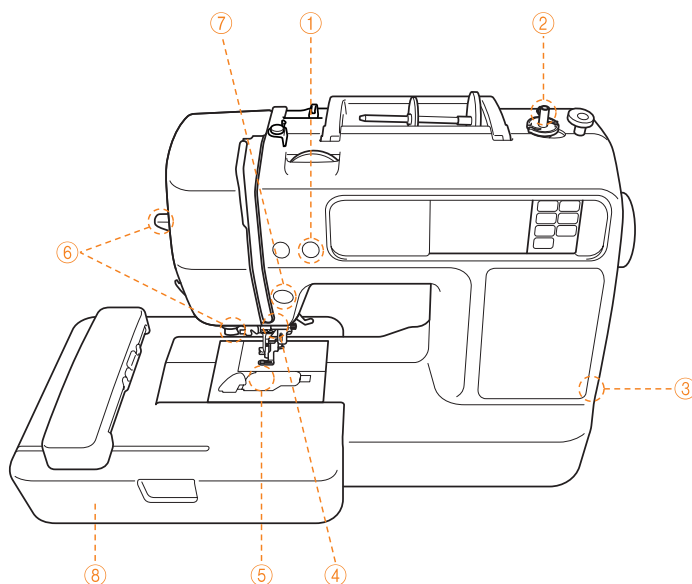

- ① **Automatic thread cutting:** The thread can be cut automatically after embroidering.
- ② **Fast bobbin winding system:** With the fast and simple bobbin winder, you can wind bobbins with one press of a button.
- ③ **USB port:** Various embroidery patterns on the website or saved in your PC become available by using the USB cable.
- ④ **Bright light:** The convenient LED lamp makes it easy to work on dark fabrics.
- ⑤ **Quick-set bobbin:** You can start embroidering without pulling up the bobbin thread.
- ⑥ **Easy-to-use needle threader:** You can thread the needle easily by one press of a lever.
- ⑦ **Lighting Start/Stop button:** When the green light is on, the machine is ready to embroider. A red or orange light indicates an error or that the machine is warming up.
- ⑧ **Embroidery:** You can embroider built-in embroidery patterns, alphanumeric characters, framed decorations, and designs from optional embroidery cards.

- ① **Automatischer Fadenabschneider:** Nach dem Sticken kann der Faden automatisch abgeschnitten werden.
- ② **Schnell-Aufspulsystem:** Mit der schnellen und einfachen Aufspulvorrichtung können Sie Spulen per Knopfdruck aufspulen.
- ③ **USB-Anschluss:** Durch die Verwendung des USB-Kabels können Sie auf die auf der Website vorhandenen oder auf Ihrem PC gespeicherten Stickmuster zugreifen.
- ④ **Helle Leuchte:** Die praktische LED-Leuchte erleichtert die Arbeit mit dunklen Stoffen.
- ⑤ **Unterfaden-Schnellautomatik:** Sie können mit dem Sticken beginnen, ohne den Unterfaden von Hand aufnehmen zu müssen.
- ⑥ **Praktischer Nadeleinfädler:** Sie können den Faden durch Betätigung eines Hebels einfädeln.
- ⑦ **Beleuchtete Start/Stopp-Taste:** Wenn die grüne Lampe brennt, ist die Maschine für den Stickvorgang bereit. Eine orangefarbene Leuchte zeigt einen Fehler an oder, dass die Maschine noch aufwärmt.
- ⑧ **Sticken:** Sie können gespeicherte Stickmuster, Buchstabenmuster, Randdekorationen und Motive von optionalen Stickmusterkarten sticken.

- ① **Découpe automatique du fil** : le fil peut être coupé automatiquement une fois la broderie terminée.
- ② **Système d'enroulement rapide des bobines** : vous pouvez bobiner les canettes d'un simple clic sur un bouton grâce au bobineur de canette simple et rapide.
- ③ **Port USB** : si vous utilisez le câble USB, vous pouvez accéder à plusieurs motifs de broderie sur le site Web ou sur votre ordinateur.
- ④ **Forte lumière** : la lampe à DEL est pratique et facilite votre travail sur des tissus sombres.
- ⑤ **Bobine à prise rapide** : vous pouvez commencer à broder sans cabrer le fil de la bobine.
- ⑥ **Enfileur d'aiguille facile à utiliser** : vous pouvez enfiler facilement l'aiguille d'un simple clic sur un levier.
- ⑦ **Bouton Marche/Arrêt de l'éclairage** : lorsque la lumière verte est allumée, la machine est prête à broder. Une lumière rouge ou orange indique une erreur ou signale le réchauffement de la machine.
- ⑧ **Broderie** : vous pouvez brocher des motifs de broderie, des caractères alphanumériques, des décorations encadrées et des dessins sur la base de patrons de broderie intégrés à la machine ou disponibles sur cartes livrées en option.

- ① **Automatisch draad afknippen**: de draad kan na het borduren automatisch worden afgeknipt.
- ② **Snel spoelopwindsysteem**: met de snelle en eenvoudige te bedienen spoelopwinder windt u spoelen op met één druk op de knop.
- ③ **USB-poort**: via de USB-kabel kunt u diverse borduurpatronen importeren vanaf de website of uw pc.
- ④ **Heldere verlichting**: de heldere LED-lamp vergemakkelijkt het werken met donkere stoffen.
- ⑤ **Snel instelbare spoel**: u kunt beginnen met borduren zonder eerst de spoeldraad omhoog te hoeven trekken.
- ⑥ **Gebruiksvriendelijke draaddoorhaler**: door de hendel één keer in te drukken haalt u de draad door de naald.
- ⑦ **Start/stop-knop met lampjes**: wanneer het groene lampje brandt, is de machine klaar voor borduren. Een rood of oranje lampje geeft aan dat er een fout is opgetreden of dat de machine aan het opwarmen is.
- ⑧ **Borduren**: u kunt werken met in de machine voorgeprogrammeerde borduurpatronen, karakters en decoraties, maar ook met ontwerpen op optionele borduurkaarten.

- ① **Taglio automatico del filo**: è possibile tagliare automaticamente il filo dopo il ricamo.
- ② **Sistema rapido di avvolgimento della spolina**: grazie all'avvolgitore spolina semplice e veloce, è possibile avvolgere le spoline premendo semplicemente un pulsante.
- ③ **Porta USB**: utilizzando il cavo USB è possibile accedere a diversi disegni per ricamo disponibili nel sito Web o salvati sul PC.
- ④ **Illuminazione intensa**: la lampada LED consente di lavorare con facilità su stoffe scure.
- ⑤ **Sistemazione rapida della spolina**: è possibile iniziare a ricamare senza fermare il filo della spolina.
- ⑥ **Infila ago facile da usare**: è possibile inserire il filo nell'ago premendo semplicemente una leva.
- ⑦ **Pulsanti di avvio/arresto luminosi**: quando la luce verde è accesa, la macchina è pronta per il ricamo. La luce rossa o arancione indica che si è verificato un errore o che la macchina è in fase di riscaldamento.
- ⑧ **Ricamo**: per il ricamo è possibile utilizzare i disegni per ricamo integrati, i personaggi, le decorazioni incorniciate e i disegni dalle schede di ricamo opzionali.

- ① **Corte automático del hilo**: El hilo se puede cortar automáticamente tras finalizar el bordado.
- ② **Sistema de devanado rápido de la bobina**: Con la rápida y simple devanadora, puede devanar bobinas con tan solo pulsar un botón.
- ③ **Puerto USB**: el cable USB permite acceder a patrones de bordado del sitio web o guardados en su ordenador personal.
- ④ **Illuminación brillante**: La lámpara LED facilita el trabajo con telas oscuras.
- ⑤ **Bobina de colocación rápida**: Puede empezar a bordar sin tener que tirar del hilo de la bobina.
- ⑥ **Enhebrador de aguja de uso fácil**: Puede enhebrar la aguja fácilmente con tan sólo presionar una palanca.
- ⑦ **Illuminación del botón iniciar/parar**: Cuando la luz verde está encendida, la máquina está lista para comenzar a bordar. Una luz roja o anaranjada indica que hay un error o que la máquina está en proceso de calentamiento.
- ⑧ **Bordado**: Puede bordar patrones incorporados, caracteres, motivos decorativos encuadrados y patrones incluidos en tarjetas de memoria de bordado opcionales.

Bobbin Winding and Setting

Aufspulen des Unterfadens und Einstellung

Bobinage et réglage de la canette

Opwinden en instellen van de spoel

Avvolgimento spolina e caricamento

Bobinado y ajuste



Follow the numbered steps below in order. Refer to the operation manual for detailed instruction.
 Führen Sie die folgenden Schritte in der angegebenen Reihenfolge aus. Ausführliche Hinweise finden Sie in der Bedienungsanleitung.
 Suivez, dans l'ordre, les étapes numérotées ci-dessous. Consultez le manuel d'instructions pour des procédures détaillées.
 Voer de genummerde stappen uit in de juiste volgorde. Uitvoerige aanwijzingen vindt u in de bedieningshandleiding.
 Seguire i passaggi numerati nell'ordine riportato di seguito. Fare riferimento al manuale d'istruzioni per le istruzioni dettagliate.
 Realice los siguientes pasos numerados en el orden indicado. Para obtener instrucciones detalladas, consulte el manual de instrucciones.

Use only the enclosed bobbin or bobbins of the same type.
 Verwenden Sie nur die im Lieferumfang enthaltene Spule oder Spulen vom selben Typ.
 N'utilisez que la canette fournie ou des canettes du même type.
 Gebruik alleen de bijgeleverde spoel of spoelen van hetzelfde type.
 Utilizzare solo la spolina inclusa o spoline dello stesso tipo.
 Utilice sólo la bobina incluida o bobinas del mismo tipo.

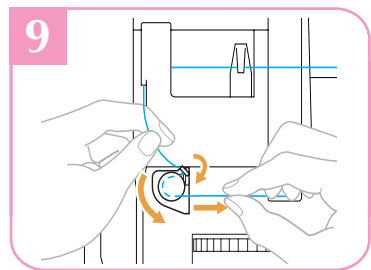
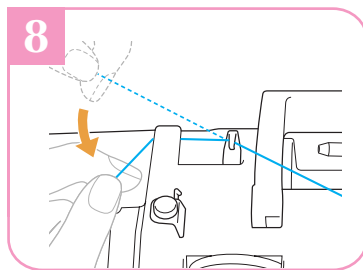
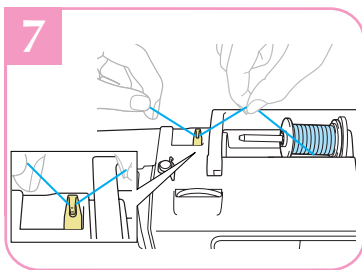
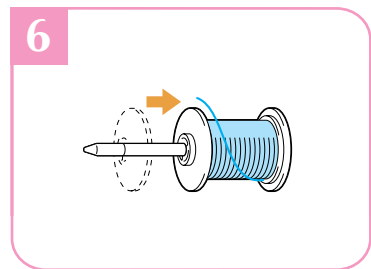
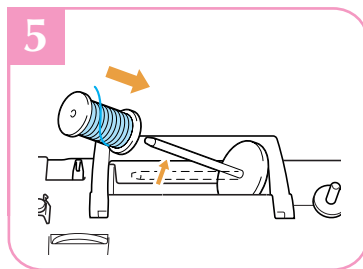
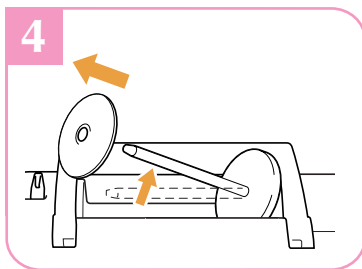
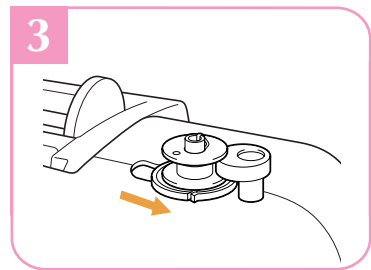
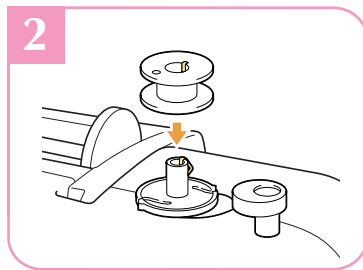
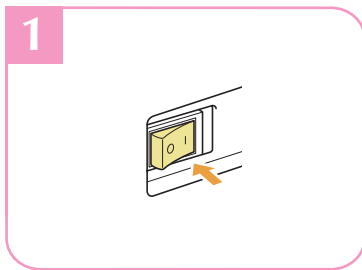
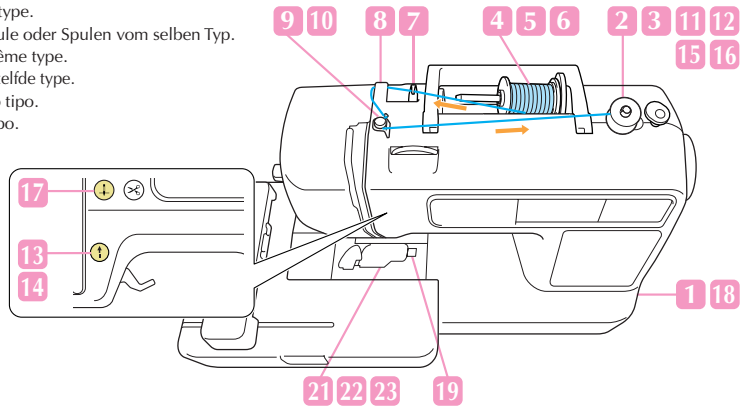
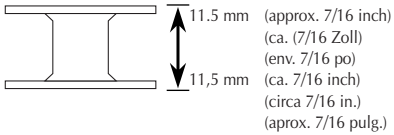

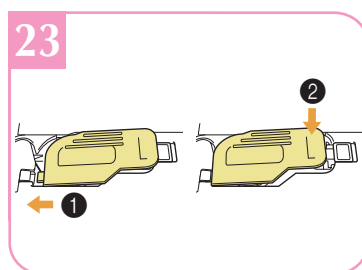
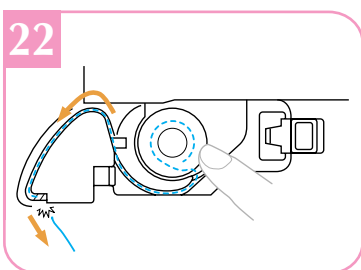
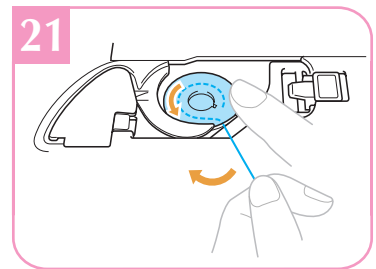
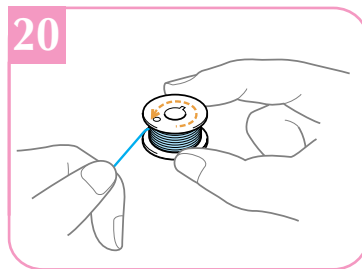
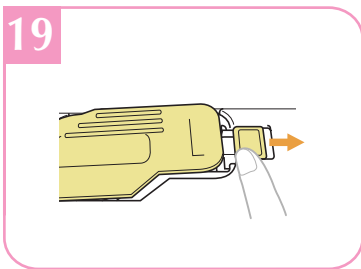
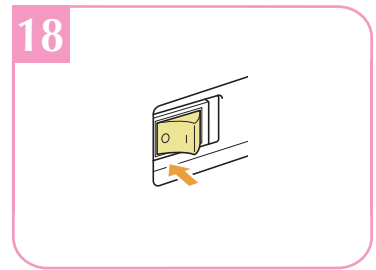
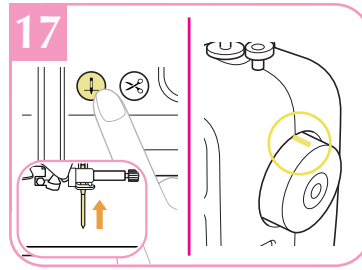
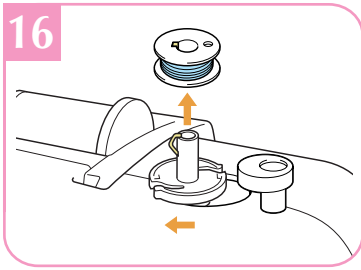
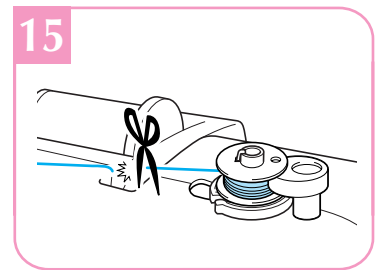
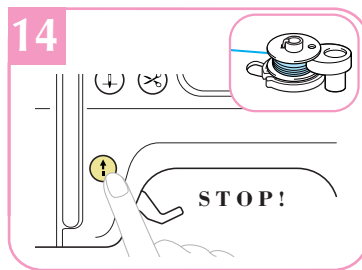
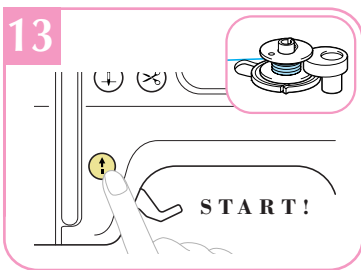
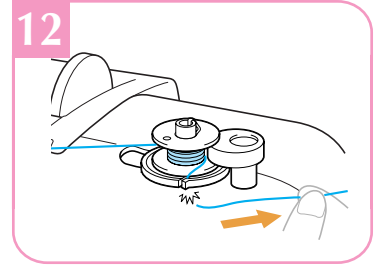
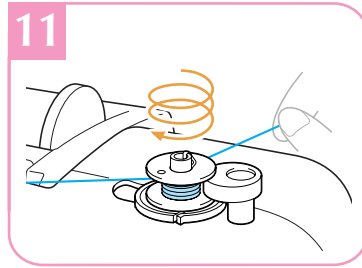
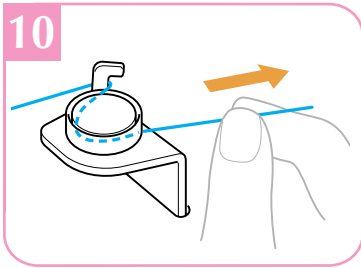

Upper Threading
 Einfädeln des Oberfadens
 Enfilage supérieur
 Inrijgen van de bovendraad
 Infilatura superiore
 Hilo superior

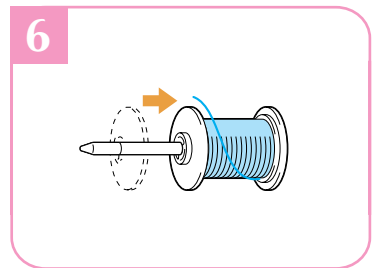
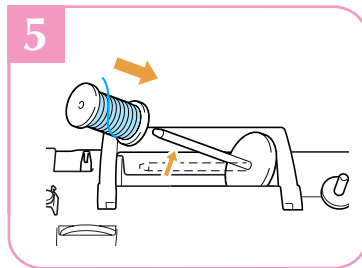
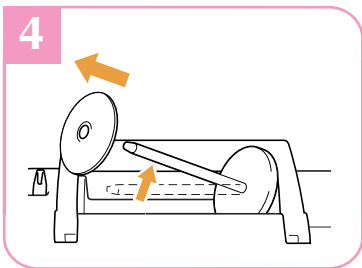
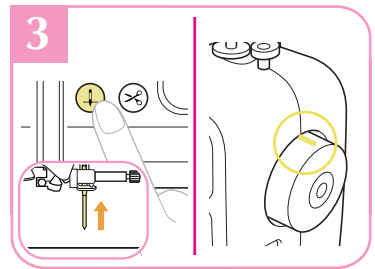
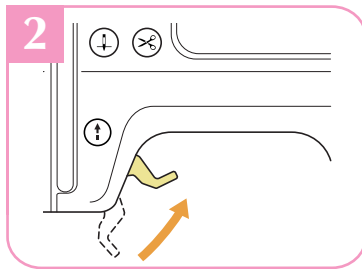
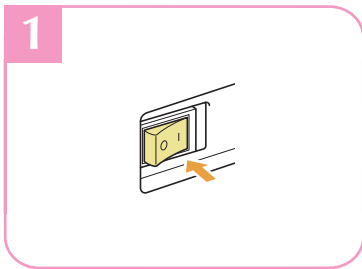
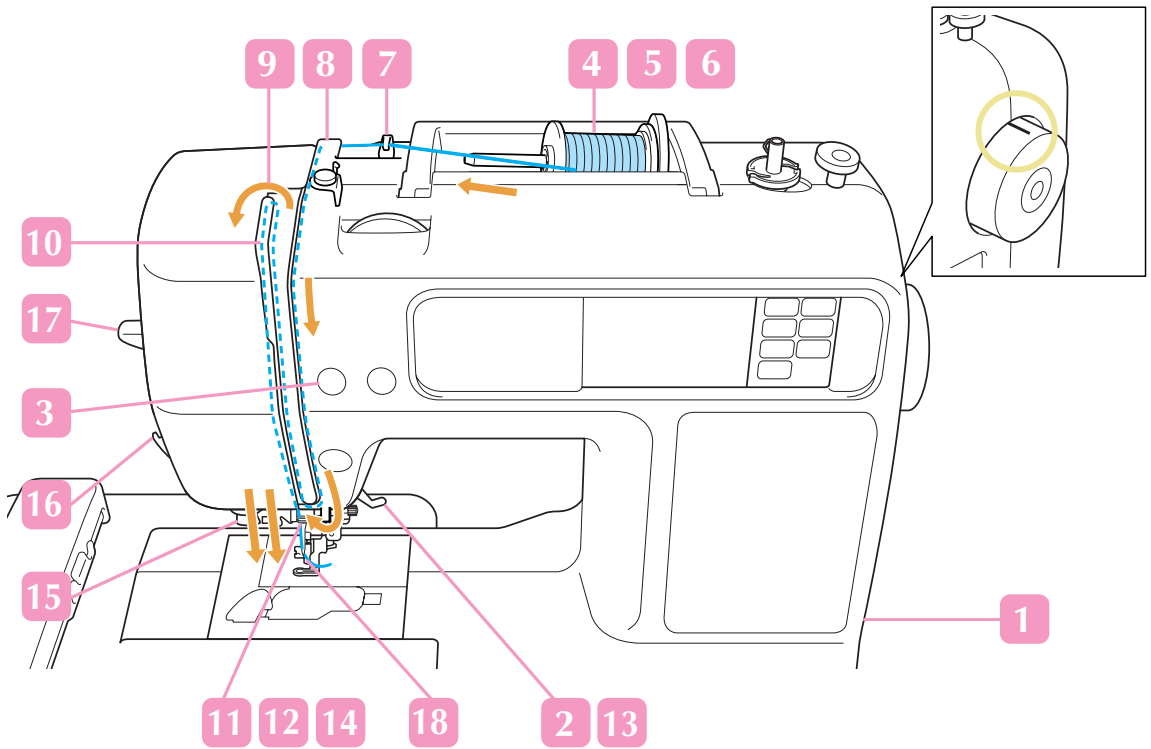

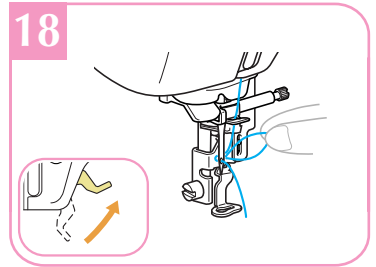
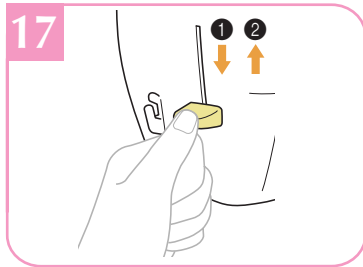
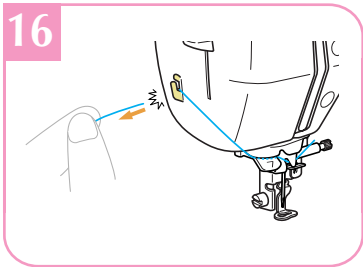
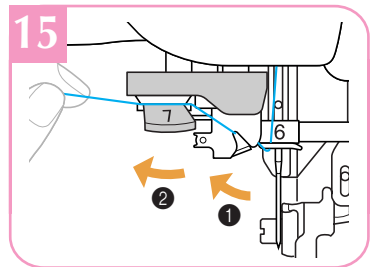
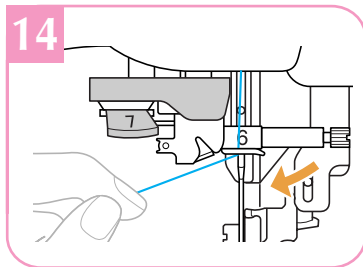
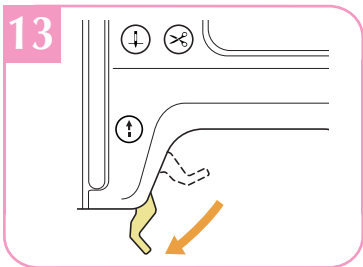
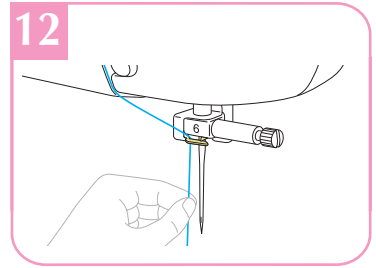
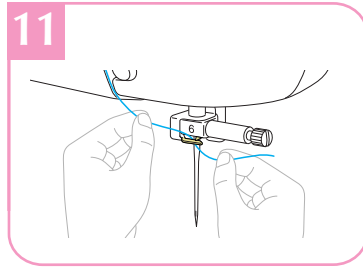
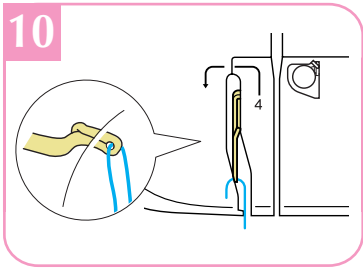
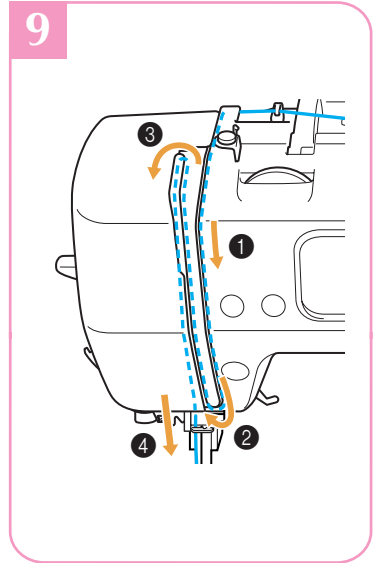
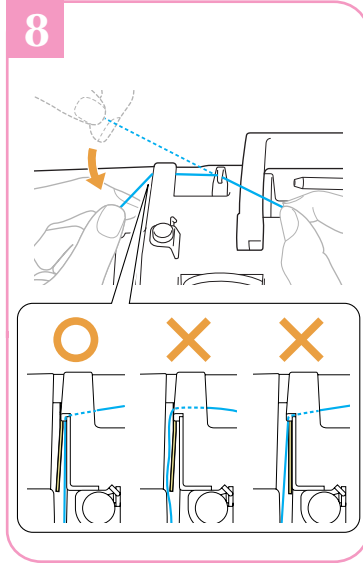
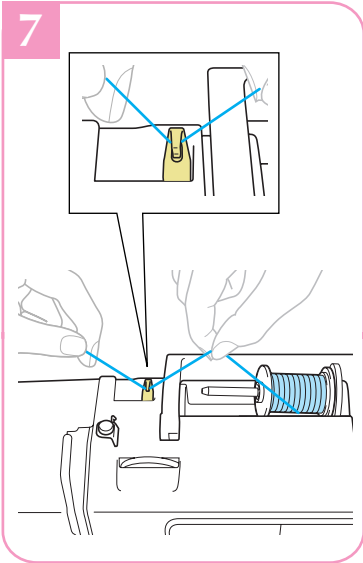

Preparing to Embroider
Vorbereitung zum Sticken
Préparation de la broderie
Vorbereidingen voor borduren
Preparativi per il ricamo
Preparativos para bordar

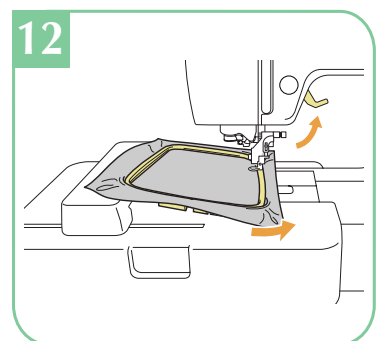
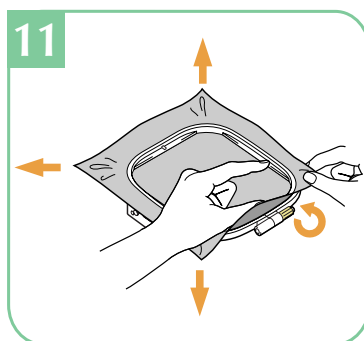
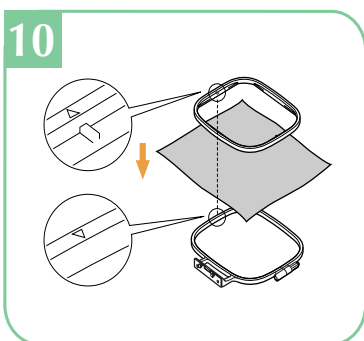
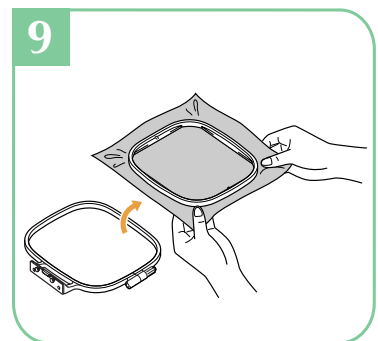
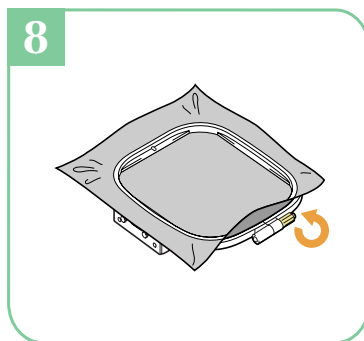
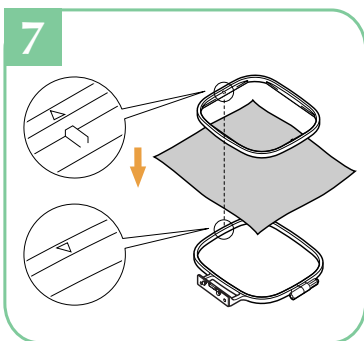
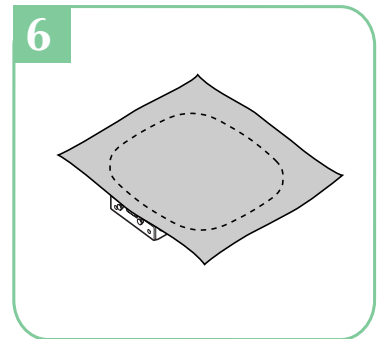
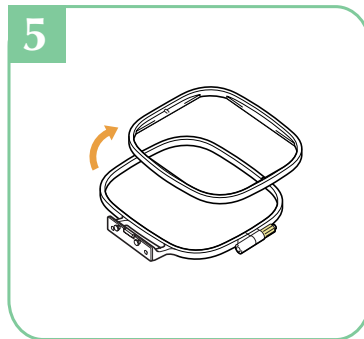
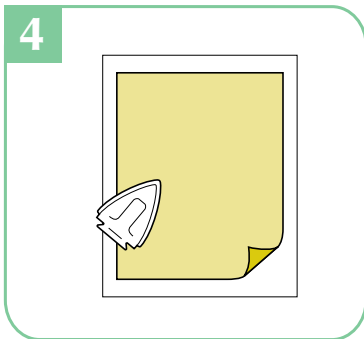
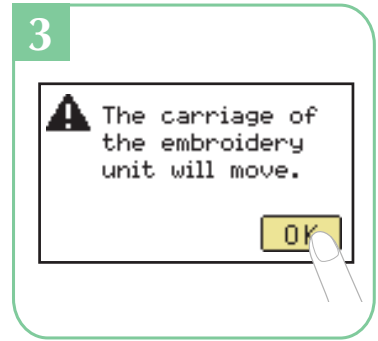
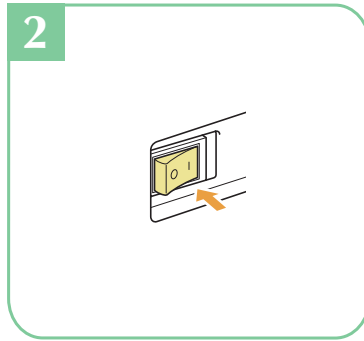
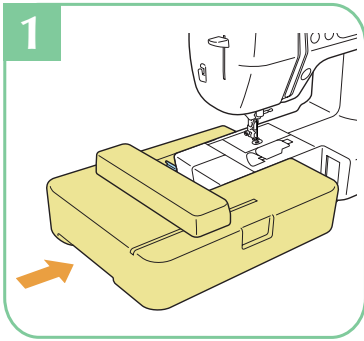

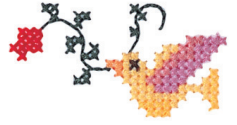

13

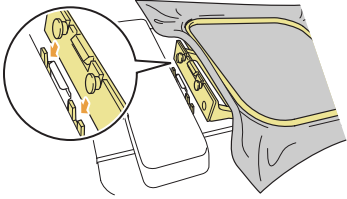

Selecting Embroidery Patterns
Wählen von Stickmustern
Sélection des motifs de broderie
Kiezen van borduurpatronen
Selezione degli schemi di ricamo
Selección de diseños de bordados

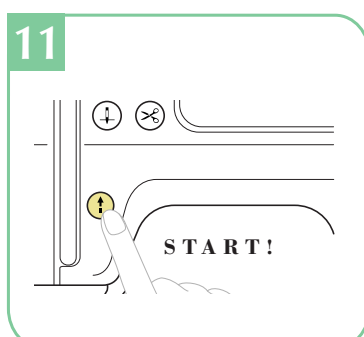
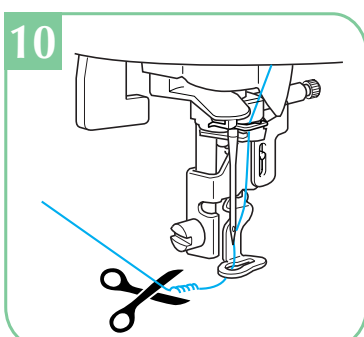
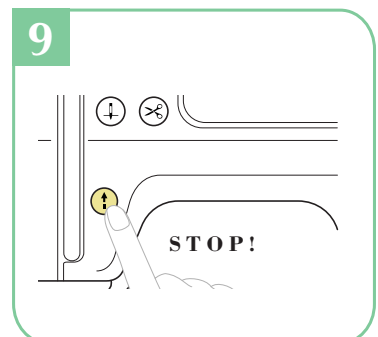
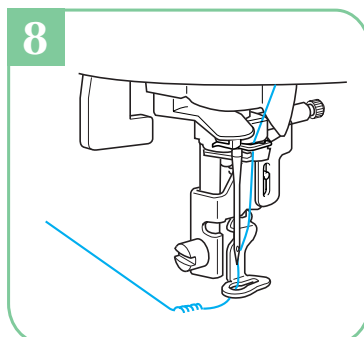
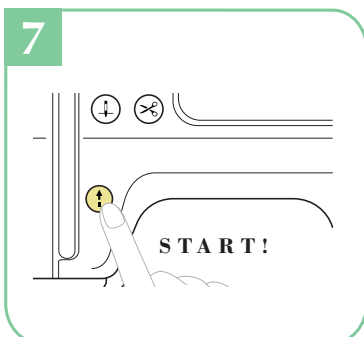
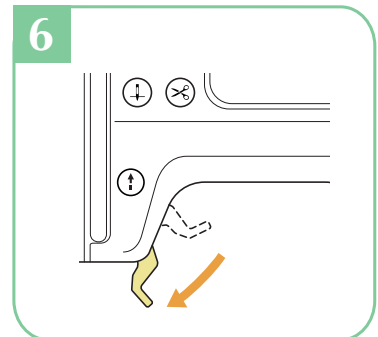
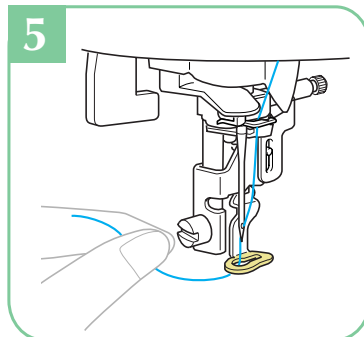
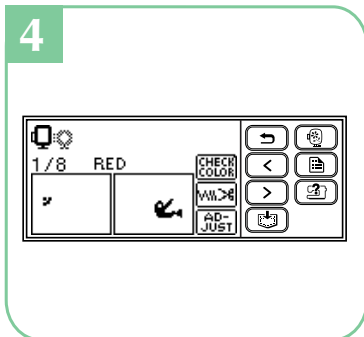
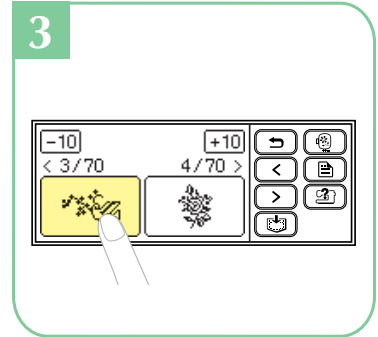
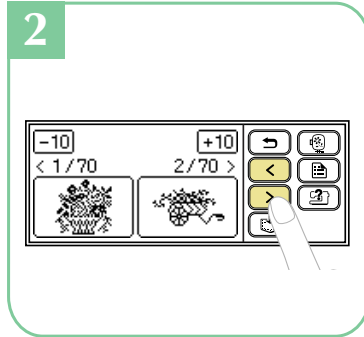
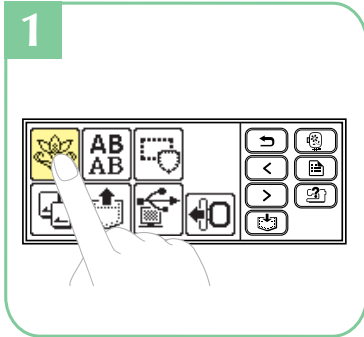

LCD Flow Chart
Schéma de procédé LCD
Diagramma di flusso LCD

LCD-Übersichtsdiagramm
Stroomschema op LCD
Diagrama de flujo del LCD

- ◆ Embroidery Patterns
- ◆ Borduurpatronen

- ◆ Stickmuster
- ◆ Schemi di ricamo

- ◆ Motifs de broderie
- ◆ Patrones de bordado

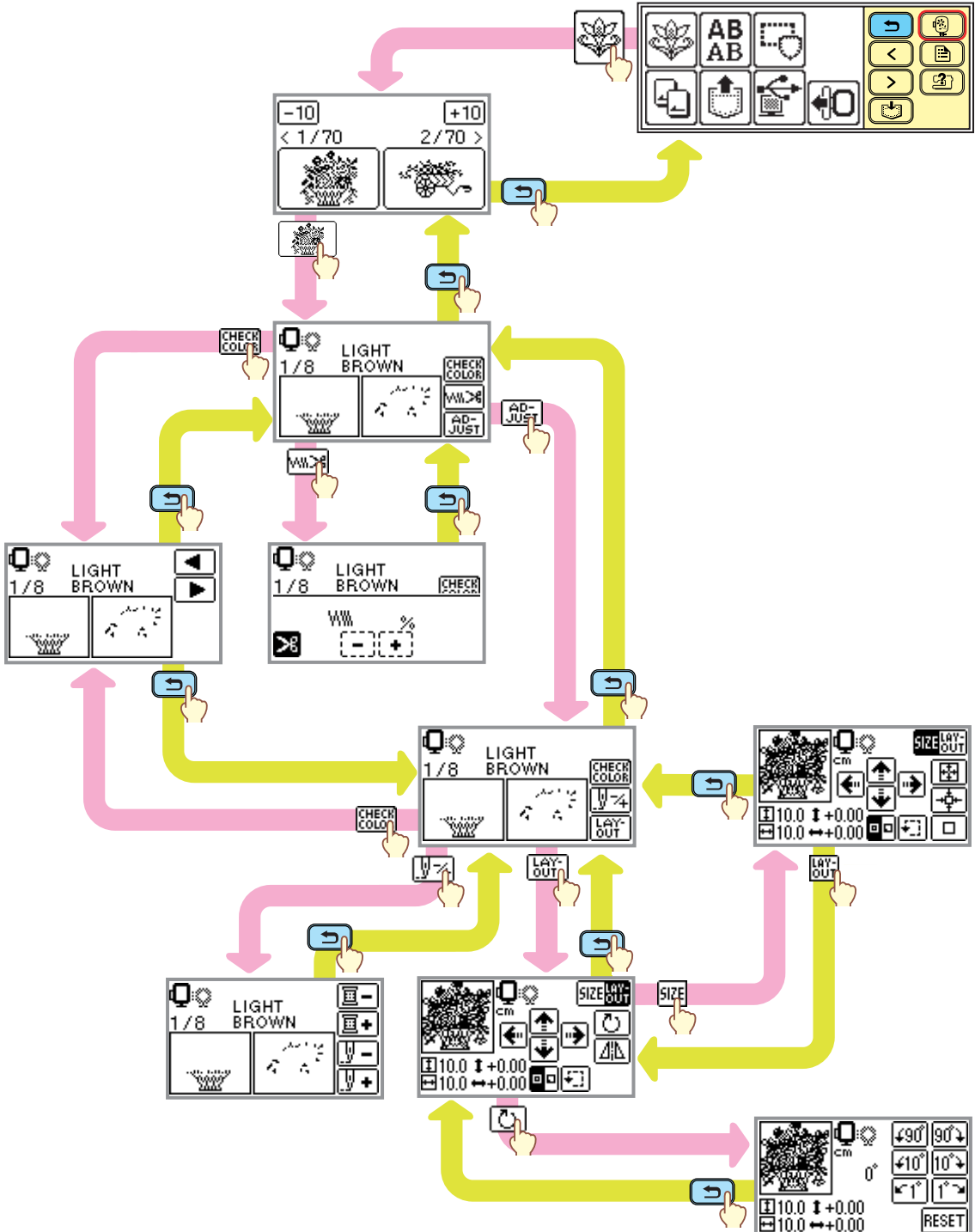

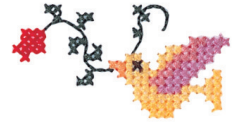

LCD Flow Chart
Schéma de procédé LCD
Diagramma di flusso LCD

LCD-Übersichtsdiagramm
Stroomschema op LCD
Diagrama de flujo del LCD

- ◆ Other Patterns ◆ Andere Muster ◆ Autres modèles
- ◆ Overige patronen ◆ Altre configurazioni ◆ Otros patrones

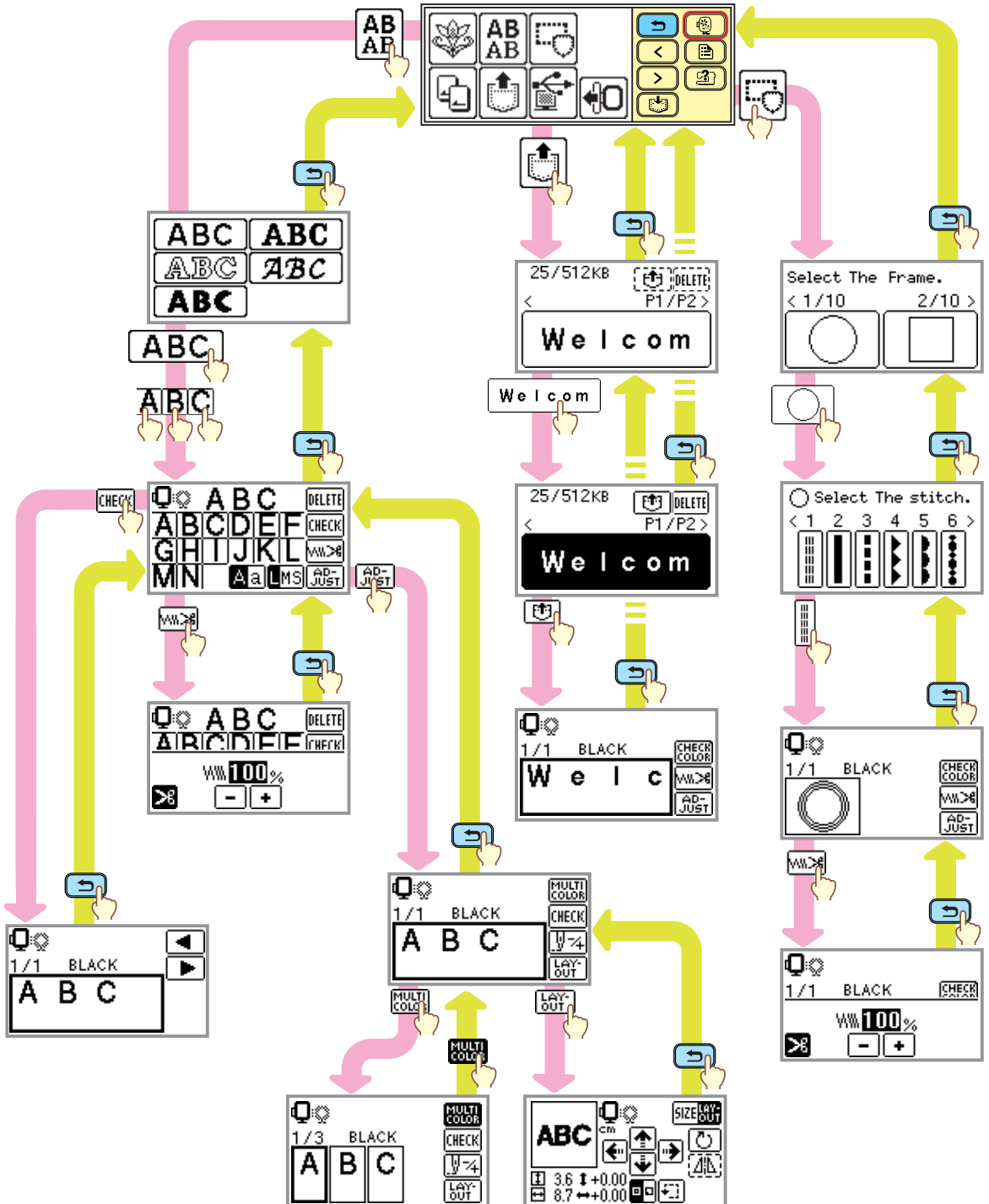

Alphanumeric Character Patterns
 Alphanumerische Buchstabenmuster
 Motifs de caractères alphanumériques
 Patronen met alfanumerieke karakters
 Schemi dei caratteri alfanumerici
 Patrón de caracteres alfanumérico



AB
AB

ABC

A B C D E F G H I J K L M N O P Q R S
 T U V W X Y Z
 a b c d e f g h i j k l m n o p q r s
 t u v w x y z
 0 1 2 3 4 5 6 7 8 9
 & ? ! - _ () ' . , /
 Ä Å Æ Æ Ñ Ö Ø Ç Ü
 ä à á â æ ë è é ê ñ ö ò ø ì ç ü ù ß

ABC

A B C D E F G H I J K L M N O P Q R S
 T U V W X Y Z
 a b c d e f g h i j k l m n o p q r s
 t u v w x y z
 0 1 2 3 4 5 6 7 8 9
 & ? ! - _ () ' . , /
 Ä Å Æ Æ Ñ ö Ø Ç Ü
 ä à á â æ ë è é ê ñ ö ò ø ì ç ü ù ß

ABC

A B C D E F G H I J K L M N O P Q R S
 T U V W X Y Z
 a b c d e f g h i j k l m n o p q r s
 t u v w x y z
 0 1 2 3 4 5 6 7 8 9
 & ? ! - _ () ' . , /
 Ä Å Æ Æ Ñ ö Ø Ç Ü
 ä à á â æ ë è é ê ñ ö ò ø ì ç ü ù ß



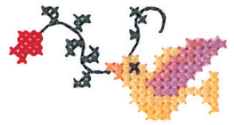

Alphanumeric Character Patterns
Alphanumerische Buchstabenmuster
Motifs de caractères alphanumériques
Patronen met alfanumerieke karakters
Schemi dei caratteri alfanumerici
Patrón de caracteres alfanumérico

ABC

A B C D E F G H I J K L M N O P Q R S
T U V W X Y Z
a b c d e f g h i j k l m n o p q r s
t u v w x y z
0 1 2 3 4 5 6 7 8 9
& ? ! - _ () ' . , /
Ä Å Ä Æ Ñ Ö Ø Ç Ü
ä å ä â æ ë è é ê ñ ö ò ø ï ç ü ù ß

ABC

A B C D E F G H I J K L M N O P Q R S
T U V W X Y Z
a b c d e f g h i j k l m n o p q r s
t u v w x y z
0 1 2 3 4 5 6 7 8 9
& ? ! - _ () ' . , /
Ä Å Ä Æ Ñ Ö Ø Ç Ü
ä å ä â æ ë è é ê ñ ö ò ø ï ç ü ù ß

Frame Patterns
Rahmenmuster
Motifs cadres
Kaderpatronen
Motivi a cornicetta
Costuras de encuadre



- Frame shapes ■ Rahmen-Formen ■ Formes de cadre
- Raamvormen ■ Forme cornici ■ Tipos de bastidores

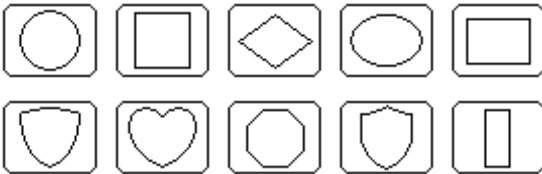



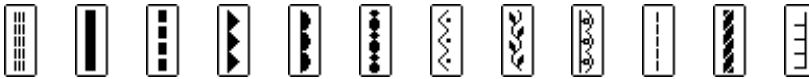

- Stitches ■ Stiche ■ Points
- Steken ■ Punti ■ Puntadas



- Sample at actual size ■ Muster in Originalgröße ■ Exemple en vraie grandeur
- Voorbeeld op ware grootte ■ Campione in dimensioni reali ■ Muestra en tamaño real

Sample combining  and  / Muster mit Kombination von  und  /

Exemple combinant  et  / Voorbeeld waarin  en  zijn gecombineerd /

Campione che combina  e  / Muestra combinando  y 

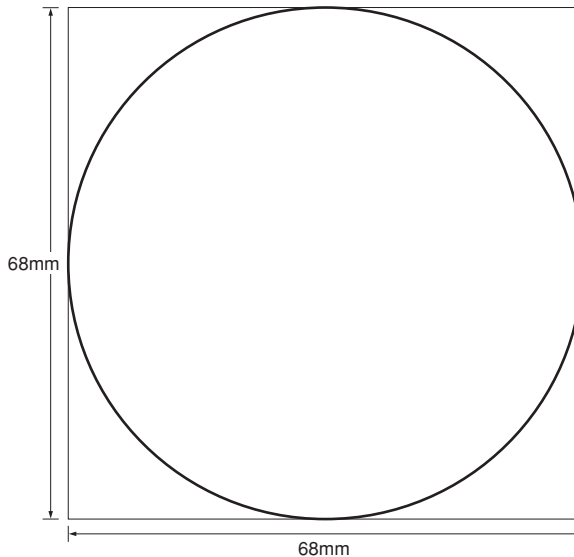

Embroidery Pattern Color Change Table

Stickmuster-Farbtabelle

Tableau de changement de couleur des motifs de broderie

Kleurwijzigingstabel voor de borduurpatronen

Tabella di cambiamento colori degli schemi di ricamo

Tabla de cambio de color para patrones de bordado



Order to embroider
Stickvorgang
Séquence pour broder
Borduurvolgorde
Sequenza operazioni di ricamo
Orden para el bordador



No.1

25 min

- 1 (255)
- 2 (463)
- 3 (444)
- 4 (155)
- 5 (024)
- 6 (224)
- 7 (334)
- 8 (485)

Time required for embroidering
Zeitaufwand beim Stickten
Durée requise pour broder
Tijd benodigd voor het borduren
Tempo di ricamo necessario
Tiempo requerido para el bordado

Embroidery thread color number
Stickgarn-Farbnnummer
Numéro de couleur du fil de broderie
Kleurnummer borduurdraad
Numero colori filo per ricamo
Número de color del hilo de bordado

10.0cm ↔ 10.0cm

COUNTRY

Embroidery thread color
Stickgarnfarbe
Couleur du fil de broderie
Kleur borduurdraad
Colore filo ricamo
Color del hilo de bordado

Embroidery size
Größe der Stickerei
Taille de la broderie
Borduurgrootte
Dimensioni del ricamo
Tecla de tamaño

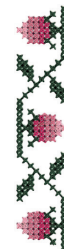

No.7

5 min

- 1 (476)
- 2 (126)
- 3 (024)
- 4 (122)

8.1cm ↔ 1.6cm

COUNTRY

No.8

23 min

- 1 (017)
- 2 (019)
- 3 (070)
- 4 (810)
- 5 (001)
- 6 (019)
- 7 (070)

9.4cm ↔ 9.4cm



No.2

10 min

- 1 (334)
- 2 (322)
- 3 (335)
- 4 (336)
- 5 (473)
- 6 (354)
- 7 (485)
- 8 (148)
- 9 (255)

4.8cm ↔ 9.4cm

COUNTRY

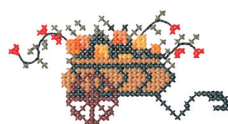

No.5

21 min

- 1 (126)
- 2 (155)
- 3 (152)
- 4 (122)
- 5 (625)
- 6 (624)
- 7 (623)
- 8 (476)
- 9 (485)
- 10 (463)
- 11 (461)
- 12 (446)
- 13 (444)
- 14 (354)
- 15 (404)
- 16 (370)
- 17 (126)
- 18 (636)
- 19 (224)
- 20 (476)

9.4cm ↔ 7.6cm

COUNTRY

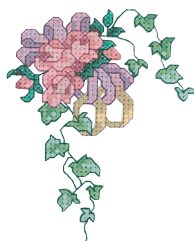

No.9

3 min

- 1 (019)
- 2 (017)
- 3 (070)

1.6cm ↔ 9.0cm

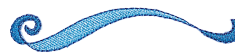

No.3

3 min

- 1 (149)
- 2 (370)
- 3 (334)
- 4 (133)
- 5 (624)
- 6 (322)
- 7 (717)
- 8 (485)

2.8cm ↔ 5.4cm

COUNTRY

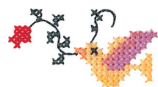

No.10

6 min

- 1 (001)
- 2 (810)
- 3 (017)
- 4 (019)
- 5 (070)

4.1cm ↔ 6.3cm



No.4

5 min

- 1 (024)
- 2 (152)
- 3 (444)
- 4 (473)
- 5 (623)

5.3cm ↔ 4.0cm

COUNTRY

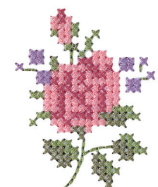

No.6

6 min

- 1 (588)
- 2 (000)
- 3 (126)
- 4 (024)
- 5 (255)
- 6 (354)
- 7 (586)

3.4cm ↔ 8.1cm

COUNTRY



No.11

21 min

- 1 (513)
- 2 (534)
- 3 (612)
- 4 (620)
- 5 (070)
- 6 (010)

9.6cm ↔ 8.6cm



No.12

17 min

1	(502)
2	(612)
3	(070)
4	(010)
5	(007)

↓7.4cm ↔ 7.4cm

No.17

6 min

1	(070)
2	(079)

↓6.9cm ↔ 6.3cm

No.23

1 min

1	(612)
---	-------

↓4.7cm ↔ 8.5cm

No.13

9 min

1	(502)
2	(010)
3	(208)

↓7.3cm ↔ 6.0cm

No.18

2 min

1	(124)
---	-------

↓2.7cm ↔ 3.0cm

No.24

1 min

1	(612)
---	-------

↓5.8cm ↔ 9.4cm

No.19

9 min

1	(017)
---	-------

↓5.9cm ↔ 8.3cm

No.25

3 min

1	(019)
2	(807)

↓4.9cm ↔ 6.2cm

No.14

20 min

1	(502)
2	(010)
3	(208)
4	(810)
5	(086)
6	(017)
7	(085)
8	(328)

↓9.6cm ↔ 6.7cm

No.20

8 min

1	(126)
---	-------

↓9.2cm ↔ 8.5cm

COUNTRY

No.26

5 min

1	(017)
2	(205)
3	(513)
4	(086)
5	(001)
6	(017)

↓3.2cm ↔ 3.4cm

No.15

4 min

1	(534)
2	(800)
3	(307)
4	(030)

↓2.7cm ↔ 4.1cm

No.21

6 min

1	(126)
---	-------

↓7.8cm ↔ 9.3cm

COUNTRY

No.27

4 min

1	(807)
2	(515)
3	(001)
4	(070)

↓3.0cm ↔ 7.9cm

No.16

10 min

1	(534)
2	(800)
3	(070)
4	(307)
5	(019)
6	(030)

↓8.9cm ↔ 9.0cm

No.22

2 min

1	(612)
---	-------

↓9.6cm ↔ 9.4cm

No.28

10 min

1	(208)
2	(205)
3	(900)
4	(620)
5	(001)
6	(515)

↓5.0cm ↔ 4.1cm

No.29

4 min

1	(337)
2	(030)
3	(058)

↓2.5cm ↔ 2.5cm



Embroidery Pattern Color Change Table
Stickmuster-Farbtabelle
Tableau de changement de couleur des motifs de broderie
Kleurwijzigingstabel voor de borduurpatronen
Tabella di cambiamento colori degli schemi di ricamo
Tabla de cambio de color para patrones de bordado

No.30 **11 min**



1	Red (800)
2	Blue (007)
3	Light Blue (307)
4	Light Blue (399)
5	Black (900)
6	Light Blue (017)
7	White (001)
8	Red (800)

↓5.6cm ↔9.0cm

No.31 **5 min**



1	Red (800)
2	Green (515)
3	Light Blue (017)
4	Light Blue (124)
5	Yellow (206)

↓3.7cm ↔3.6cm

No.32 **9 min**



1	Blue (586)
2	Light Blue (025)
3	Green (473)
4	Light Blue (242)
5	Brown (224)
6	Brown (255)
7	Black (747)

↓5.0cm ↔5.0cm

COUNTRY 

No.33 **20 min**



1	Green (513)
2	White (001)
3	Brown (323)
4	Red (800)
5	Light Blue (017)
6	Pink (810)
7	Black (900)
8	Green (513)
9	White (001)
10	Brown (323)
11	Blue (019)
12	Blue (070)
13	Black (900)
14	Brown (058)
15	Green (502)
16	Blue (704)
17	Black (900)

↓9.6cm ↔6.5cm

No.34 **3 min**



1	White (001)
2	Light Blue (307)
3	Black (707)

↓2.6cm ↔2.4cm

No.35 **5 min**



1	White (001)
2	Brown (323)
3	Light Blue (010)
4	Black (900)

↓3.4cm ↔3.8cm

No.36 **5 min**



1	White (001)
2	Light Blue (843)
3	Black (707)
4	Black (900)

↓4.0cm ↔2.7cm

No.37 **3 min**



1	White (001)
2	Blue (405)
3	Light Blue (017)
4	Red (800)

↓3.2cm ↔3.3cm

No.38 **1 min**



1	Red (800)
2	Light Blue (017)
3	Brown (339)

↓1.6cm ↔2.5cm

No.39 **3 min**



1	Grey (704)
---	------------

↓2.3cm ↔3.0cm

★ No.40 **3 min**



1	Red (107)
2	Red (107)
3	Red (107)
4	Black (328)

↓4.9cm ↔4.8cm

No.41 **5 min**



1	Red (800)
2	Yellow (205)
3	White (001)
4	Green (507)
5	Black (900)

↓2.4cm ↔5.7cm

No.42 **2 min**



1	Yellow (205)
2	Blue (405)
3	Green (507)
4	Red (800)
5	Black (900)

↓2.4cm ↔5.8cm

★ No.43 **7 min**



1	Red (019)
2	Blue (019)
3	Blue (019)
4	Yellow (205)
5	Green (507)
6	Blue (007)
7	Black (900)

↓5.6cm ↔5.7cm

★ No.44 **17 min**







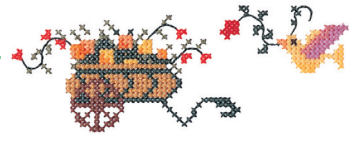

1	Red (800)
2	Red (800)
3	Red (800)
4	Blue (019)
5	Red (800)
6	Green (513)
7	Light Blue (124)
8	Pink (085)
9	Red (086)



↓6.2cm ↔6.2cm



- ★ Refer to the operation manual for the sewing machine for details on how to embroider appliqués.
- ★ Für Einzelheiten zum Sticken der Applikationen wird auf die Bedienungsanleitung der Nähmaschine verwiesen.
- ★ Se reporter au mode d'emploi de la machine à coudre pour la façon de broder les appliqués.
- ★ Zie de bedieningshandleiding van de naaimachine voor nadere bijzonderheden betreffende het borduren van de appliqués.
- ★ Per istruzioni dettagliate sul ricamo delle applique consultare il manuale d'istruzioni della macchina per cucire.
- ★ Consulte el manual de instrucciones de la máquina de coser para los detalles sobre cómo bordar los apliques.









No.45  
 1  (070)
 ⇅3.1cm ⇔3.9cm

No.54  
 1  (070)
 ⇅4.5cm ⇔3.1cm



No.63  
 1  (070)
 ⇅3.1cm ⇔2.9cm



No.46  
 1  (070)
 ⇅3.1cm ⇔3.6cm



No.55  
 1  (070)
 ⇅3.1cm ⇔4.0cm



No.64  
 1  (070)
 ⇅3.4cm ⇔3.4cm



No.47  
 1  (070)
 ⇅3.1cm ⇔2.9cm



No.56  
 1  (070)
 ⇅3.1cm ⇔3.1cm



No.65  
 1  (070)
 ⇅3.1cm ⇔3.7cm



No.48  
 1  (070)
 ⇅3.1cm ⇔3.1cm



No.57  
 1  (070)
 ⇅3.1cm ⇔4.6cm



No.66  
 1  (070)
 ⇅3.1cm ⇔3.5cm



No.49  
 1  (070)
 ⇅3.1cm ⇔2.8cm



No.58  
 1  (070)
 ⇅3.1cm ⇔4.3cm



No.67  
 1  (070)
 ⇅3.1cm ⇔5.3cm

No.50  
 1  (070)
 ⇅3.5cm ⇔3.2cm



No.59  
 1  (070)
 ⇅3.1cm ⇔2.6cm

No.68  
 1  (070)
 ⇅3.1cm ⇔3.8cm

No.51  
 1  (070)
 ⇅3.1cm ⇔2.4cm



No.60  
 1  (070)
 ⇅3.1cm ⇔3.2cm

No.69  
 1  (070)
 ⇅3.1cm ⇔2.9cm

No.52  
 1  (070)
 ⇅3.2cm ⇔4.2cm

No.61  
 1  (070)
 ⇅3.1cm ⇔2.6cm

No.70  
 1  (070)
 ⇅4.5cm ⇔3.3cm

No.53  
 1  (070)
 ⇅3.1cm ⇔2.7cm

No.62  
 1  (070)
 ⇅3.1cm ⇔3.7cm



Color Thread Conversion Chart

Stickgarn-Farbtabelle

Tableau de conversion des fils de couleur

Omzettingstabel voor kleurgaren

Tabella di conversione dei fili colorati

Tabla de conversión de hilos de color



	Color Name	Embroidery	Country	Madeira Polyneon	Madeira Rayon	Sulky Rayon	R.A. Polyester
1	Black / Schwarz / Noir / Zwart / Nero / Negro	900	100	1800	1000	1005	5596
2	White / Weiss / Blanc / Wit / Bianco / Blanco	001	000	1801	1002	1001	5597
3	Red / Rot / Rouge / Rood / Rosso / Rojo	800	149	1637	1037	1037	5678
4	Pink / Rosa / Rose / Rose / Rosa / Rosado	085	155	1921	1108	1224	5523
5	Deep Rose / Tiefrot / Rose fonce / Roserood / Rosa Intenso / Rosa Intenso	086	024	1721	1117	1154	9168
6	Flesh Pink / Fleisch Farben / Rose chair / Lichtrose / Rosa Carne / Rosa Claro	124	152	1915	1015	1064	5677
7	Dark Fuchsia / Dunkel Violett / Fuchsia fonce / Donker Fuchsia Paars / Fuchsia Scuro / Fuscia Oscuro	107	126	1984	1383	1533	5804
8	Vermilion / Zinnober Rot / Vermillon / Vermil Joen / Rosso Vermiglio / Bermellon	030	148	1779	1179	1184	9023
9	Carmine / Karminrot / Carmin / Karmijn / Rosso Carmino / Carmin	807	158	1986	1081	1511	5561
10	Royal Purple / Königs Purpur / Pourpre royal / Dieppaars / Rosso-Violeaceo / Violeta Real	869	636	1788	1188	1192	5681
11	Magenta / Magenta / Magenta / Magenta / Magenta	620	625	1710	1319	1191	5592
12	Salmon Pink / Lachsrosa / Rose saumon / Zalmrose / Rosa Salmore / Rosa Salmon	079	122	1816	1317	1225	5773
13	Amber Red / Bern Steinrot / Rouge ambre / Amber Rood / Rosso Ambr / Rojo Ambar	333	212	1942	1341	1119	5591
14	Lemon Yellow / Zitronen Gelb / Jaune citron / Citro Engeel / Giallo Limone / Amarillo Limon	202	342	1623	1023	1067	5625
15	Yellow / Gelb / Jaune / Geel / Giallo / Amarillo	205	043	1980	1068	1187	5860
16	Harvest Gold / Erntegold / Or ble / Oogst Kleurig Goud / Giallo Grano / Amarillo Trigo	206	334	1971	1024	1124	5770
17	Orange / Orange / Orange / Oranje / Arancio / Naranja	208	335	1951	1137	1024	5694
18	Pumpkin / Kürbis Gelb / Citrouille / Pompoen / Giallo Zucca / Calabaza	126	322	1952	1155	1065	5630
19	Tangerine / Mandari Nenorange / Tangerine / Felorange / Mandarino / Tangerina	209	336	1965	1078	1078	5518
20	Cream Brown / Braun Weiss / Brun creme / Creme Bruin / Nocciola / Marron Crema	010	331	1866	1022	1061	5761
21	Cream Yellow / Gelblich Weiss / Jaune creme / Cremegeel / Giallo Crema / Amarillo Crema	812	370	1861	1349	1135	5564
22	Khaki / Khaki Braun / Kaki / Khaki / Kaki / Caqui	348	242	1939	1255	1055	5636
23	Deep Gold / Tiefgold / Or fonce / Diepgoud / Oro Scuro / Amarillo Oro	214	354	1772	1172	1025	5770
24	Brass / Messin G Farben / Cuivre / Koper / Ottone / Bronze	328	404	1791	1192	1159	9109
25	Linen / Leinen Farbig / Drap / Linnen / Lino / Lino	307	025	1682	1149	1082	5635
26	Dark Brown / Dunkel Braun / Brun sombre / Donker Bruin / Marrone Scuro / Marron Oscuro	058	717	1859	1130	1129	5637
27	Reddish Brown / Rotbraun / Brun rougeatre / Rosing Bruin / Marrone Bruciato / Marron Rojizo	337	264	1753	1253	1021	5781
28	Clay Brown / Lehm Braun / Brun argile / Kleibruin / Marrone Argilla / Marron Tierra	339	224	1621	1021	1158	5590
29	Beige / Beige / Beige / Beige / Beige / Beige	843	012	1738	1138	1127	5598
30	Warm Gray / Warmgrau / Gris vif / Warm Grijs / Grigio Caldo / Gris Caliente	399	706	1860	1085	1218	9126
31	Russet Brown / Rotbraun / Brun rousatre / Roodbruin / Ruggine / Marron Bermejo	330	414	1726	1194	1126	5702
32	Light Brown / Hellbraun / Brun clair / Licht Bruin / Marrone Chiaro / Marron Claro	323	255	1729	1056	1128	5789
33	Seacrest / Blassgrün / Vert pale / Blauw Groen / Cresta Di Mare / Verde Celadon	542	505	1647	1219	1077	5578
34	Mint Green / Pfeffer Minzgrün / Vert menthe / Munt Groen / Verde Menta / Verde Menta	502	461	1702	1302	1047	5511
35	Leaf Green / Blattgrün / Vert feuille / Bladgroen / Verde Prato / Verde De Hoja	509	463	1749	1050	1510	5514
36	Olive Green / Olivgrün / Vert olive / Olijf Groen / Verde Oliva / Verde Oliva	519	476	1904	1396	1174	5502
37	Dark Olive / Dunkel Olivgrün / Olive fonce / Donker Olijf / Oliva Scuro / Verde Oliva Oscuro	517	473	1769	1156	1156	9122
38	Teal Green / Blaugrün / Vert sarcelle / Taling Groen / Verde Anatra / Verde Azulado	534	483	1879	1298	1503	5751
39	Emerald Green / Emerald Grün / Vert emeraude / Smaragd Groen / Verde Smeraldo / Verde Esmeralda	507	485	1750	1250	1079	5508
40	Deep Green / Dunkel Grün / Vert fonce / Diepgroen / Verde Intenso / Verde Intenso	808	467	1703	1370	1208	5615

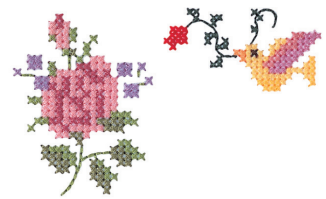

	Color Name	Embroidery	Country	Madeira Polyneon	Madeira Rayon	Sulky Rayon	R.A. Polyester	
41	Fresh Green / Frisch Grün / Vert frais / Licht Groen / Verde Mela / Verde Fresco	027	442	1706	1102	1209	9153	
42	Lime Green / Limonen Grün / Vert tilleul / Limoen Groen / Verde Tiglio / Verde Lima	513	444	1848	1049	1177	5622	
43	Moss Green / Moosgrün / Vert mousse / Mosgroen / Verde Muschio / Verde Musgo	515	446	1770	1369	1176	9091	
44	Blue / Blau / Bleu / Blauw / Azzurro / Azul	405	586	1829	1177	1076	5684	
45	Ultra Marine / Ultra Marin / Outremer / Ultra Marijn / Blu Oltremare / Azul De Ultramar	406	575	1842	1076	1042	5736	
46	Light Blue / Hellblau / Bleu clair / Licht Blauw / Celeste / Azul Claro	017	150	1932	1132	1074	5683	
47	Sky Blue / Himmel Blau / Bleu ciel / Hemels Blauw / Azzurro Cielo / Celeste	019	512	1828	1029	1196	5506	
48	Electric Blue / Elek-Trisch-Blau / Bleu électrique / Staal Blauw / Blu Elettrico / Azul Electrico	420	564	1797	1297	1250	5829	
49	Peacock Blue / Pfauen Blau / Bleu paon / Pauwen Blauw / Blu Pavone / Azul Pavo Real	415	057	1652	1252	1206	5810	
50	Prussian Blue / Berliner Blau / Bleu de Prusse / Pruisisch Blauw / Blu De Prussia / Azul De Prusia	007	588	1767	1166	1535	5737	
51	Cornflower Blue / Kornblu Menblau / Bleu centauree / Koren Bloemen Blauw / Blu Fior-Daliso / Azul Centaura	070	015	1830	1335	1028	5601	
52	Light Lilac / Helllila / Lilas clair / Licht Lila / Lilla Chiaro / Lila Suave	810	133	1911	1031	1121	9016	
53	Lilac / Lila / Lilas / Lila / Lilla / Lila	612	623	1831	1080	1080	9009	
54	Violet / Violett / Violet / Violet / Violetto / Violeta	613	624	1631	1033	1194	5588	
55	Purple / Purpur / Pourpre / Paars / Viola / Purpura	614	635	1880	1122	1122	5554	
56	Lavender / Lavendel / Lavande / Lavendel / Lavanda / Lavanda	804	604	1630	1261	1193	5586	
57	Wisteria Violet / Wistaria Violet / Violet glycine / Blauwe Regen Paars / Glicine / Violeta Vistaria	607	003	1943	1311	1032	5587	
58	Pewter / Zinngrau / Etain / Tinkleurig / Peltro / Peltre	704	745	1840	1041	1041	9114	
59	Dark Gray / Dunkel Grau / Gris sombre / Donker Grijs / Grigio Scuro / Gris Oscuro	707	747	1841	1241	1220	5565	
60	Silver / Silber / Argent / Zilver / Argento / Plata	005	020	1812	1087	1011	5640	
61	Gray / Grau / Gris / Grijs / Grigio / Gris	817	734	1640	1118	1219	5782	
62		-----✂						
63		-----						
64		~~~~~ 						
65	NOT DEFINED / NICHT DEFINIERT / NON DÉFINI / NIET GEDEFINIEERD / NON DEFINITO / SIN DEFINIR							

Note: The conversion chart is based on Embroidery thread. The color shades may vary with the different brands listed on the chart. If unsure of a particular color(s), please sew test. Robison Anton, Isacord, Maderia, Sulky and Gütermann are respectively registered trademarks. Actual colors may vary slightly from the chart.

Hinweis: Die Umrechnungstabelle basiert auf dem Stickgarn. Die Farbschattierungen können je nach unterschiedlichen in der Tabelle aufgeführten Marken abweichen. Wenn Sie sich bezüglich bestimmter Farben nicht sicher sind, nähern Sie bitte zur Probe. Robison Anton, Isacord, Maderia, Sulky und Gütermann sind eingetragene Warenzeichen. Die tatsächlichen Farben können leicht von der Tabelle abweichen.

Remarque: Le tableau de conversion est basé sur un fil de broderie. Les nuances de couleur peuvent varier en fonction des marques énumérées dans le tableau. En cas de doute sur un coloris, faites un essai de couture. "Robison Anton", "Isacord", "Maderia", "Sulky" et "Gütermann" sont des marques déposées respectives. Les couleurs réelles risquent d'être légèrement différentes de celles du tableau.

Opmerking: Het omzettingsschema is gebaseerd op het gebruik van borduurzijde. De kleurtinten kunnen ietwat verschillen voor de diverse merken in het schema. Als u niet zeker bent van de juiste kleur(en), borduurt u dan een stukje op proef. De namen Robison Anton, Isacord, Maderia, Sulky en Gütermann zijn allemaal gedeponeerde handelsmerken. De feitelijke kleurtinten kunnen iets afwijken van het getoonde schema.

Nota: la tabella di conversione è in funzione del filo da ricamo. Le tonalità cromatiche possono variare secondo le differenti marche elencate nella tabella. In caso di dubbio su un particolare colore o su più colori si raccomanda di eseguire una prova di cucito. Robison Anton, Isacord, Maderia, Sulky e Gütermann sono marchi di fabbrica registrati. I colori effettivi possono variare lievemente rispetto a quelli della tabella.

Nota: La tabla de conversión está basada en hilo de bordar. Los tonos de color podrán variar con las diferentes marcas listadas en la tabla. Si tiene dudas sobre un color(es) particular, haga un cosido de prueba. "Robison Anton", "Isacord", "Maderia", "Sulky" y "Gütermann" son marcas registradas respectivamente. Los colores verdaderos podrán variar ligeramente con respecto a los de la tabla.

