

brother

**TZe**  
**TAPE**

*P-touch* embellish

***PT-D215e***

**User's Guide**

**English**

brother

TZe  
TAPE

P-touch embellish

## PT-D215e User's Guide

English

Thank you for purchasing Brother's P-touch Embellish! Use your new Brother P-touch Embellish, a ribbon and tape printer, to create a wide variety of custom, self-adhesive labels and ribbons. This ribbon and tape printer uses Brother TZe tapes. TZe tape cassettes are available in many color and sizes. For a complete list of tapes compatible with your machine, visit us at: [www.brother.com](http://www.brother.com).

Please read this guide, including all Precautions, before using this machine. After reading this guide, keep it in a safe place.

Printed in China  
D00NU2001



## Safety Precautions

### ! WARNING

Indicates a potentially hazardous situation which, if not avoided, could result in death or serious injuries.

Follow these guidelines to avoid the risk of fire, burns, injury, electric shocks, rupture, overheating, abnormal odours or smoke.

- Always use the specified voltage and the suggested AC Adapter (AD-24ESA) for the P-touch ribbon/tape printer to prevent any damage or failure.
- Do not touch the P-touch ribbon/tape printer during a lightning storm.
- Do not use the P-touch ribbon/tape printer / AC Adapter in places of high humidity such as bathrooms.
- Do not overload the power cord.
- Do not place heavy objects on, or damage the power cord or plug. Do not forcibly bend or pull the power cord. Always hold the AC Adapter when disconnecting from the power outlet.
- Make sure that the plug is fully inserted to the power outlet. Do not use an outlet that is loose.
- Do not allow the P-touch ribbon/tape printer / AC Adapter / power plug / batteries to get wet, for example, by handling them with wet hands or spilling beverages on to them.
- Since loss of eyesight may result when leaked fluid from batteries gets into your eyes, immediately rinse your eyes with a large amount of clean water, and then seek medical attention.
- Do not disassemble or modify the P-touch ribbon/tape printer / AC Adapter / batteries.
- Do not allow a metal object to contact both the plus and minus ends of a battery.
- Do not use sharp objects, such as tweezers or a metallic pen, to change the batteries.
- Do not throw the batteries into fire or expose to heat.
- Disconnect the AC Adapter and remove batteries immediately and stop using the P-touch ribbon/tape printer if you notice abnormal odor, heat, discoloration, deformation or anything unusual while using or storing it.
- Do not use a damaged or leaking battery as the fluid may get on your hands.
- Do not use a deformed or leaking battery or one whose label is damaged. There is a possibility of generating heat.

## 1 GETTING STARTED

### Installing Power Supply and Ribbon Cassette or Tape Cassette

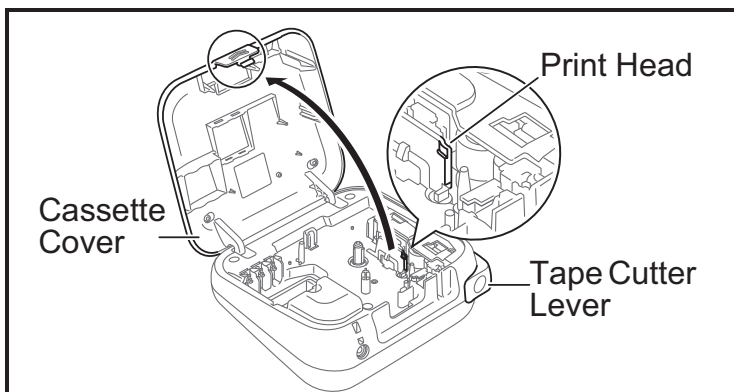

With the LCD facing down, open the Cassette Cover by pressing the grooved tab and pushing in the direction of the arrow, as illustrated.

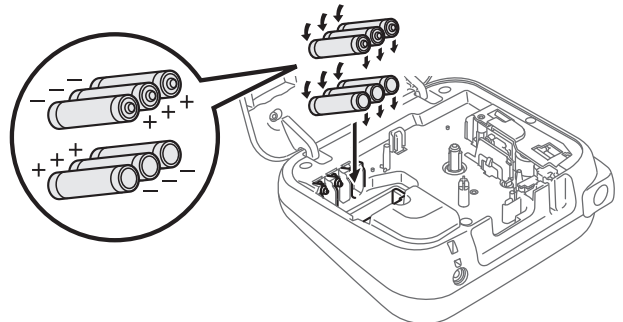

When replacing batteries or tape cassettes, make sure the power is turned off.

This ribbon/tape printer requires six (6) AAA alkaline batteries or six (6) fully-charged Ni-MH batteries, not included.

## ⚠ CAUTION

Indicates a potentially hazardous situation which, if not avoided, may result in minor or moderate injuries.

### Follow these guidelines to avoid personal injury, liquid leakage, burns or heat.

- When the P-touch ribbon/tape printer is not being used, store it out of the reach of children. In addition, do not allow children to put the P-touch ribbon/tape printer parts or ribbons/tapes in their mouths. If any object has been swallowed, seek medical attention.
- Do not touch metal parts around the print head immediately after printing.
- Do not touch the cutter blade.
- If leaked fluid from batteries gets on your skin or clothes, immediately rinse them with clean water.
- Remove the batteries and disconnect the AC Adapter if you do not intend to use the P-touch ribbon/tape printer.
- Do not use a battery other than that specified. Do not use combinations of old and new batteries or combinations of different types, different charging levels, different manufacturers or different models. Do not insert a battery with its plus and minus ends reversed.
- Do not drop or hit the P-touch ribbon/tape printer / AC Adapter.
- Do not press on the LCD display.
- Do not put your finger inside the P-touch ribbon/tape printer when you close the cassette cover.
- Before using Ni-MH rechargeable batteries, carefully read the instructions for the batteries and battery charger, and be sure to use them correctly.
- When using Ni-MH rechargeable batteries, charge the batteries with a specialized battery charger before using the batteries.

## General Precautions

- Depending on the location, material, and environmental conditions, the ribbon/tape may peel or become irremovable, the color of the ribbon/tape may change or be transferred to other objects. Before applying the ribbon/tape, check the environmental conditions and the material.
- Do not use the P-touch ribbon/tape printer in any way or for any purpose not described in this guide. Doing so may result in accidents or damage the P-touch ribbon/tape printer.
- Use only Brother TZe tapes with the P-touch ribbon/tape printer. Do not use tapes that do not have the **TZe** mark.
- Only use a soft, dry cloth to clean the ribbon/tape printer; never use alcohol or other organic solvents.
- Use a soft, lint free cloth to clean the print head. Never touch the print head directly with your hands.

- Do not put any foreign objects into the tape exit slot, AC Adapter connector, battery compartment, etc.
- Do not place the P-touch ribbon/tape printer / batteries / AC Adapter in direct sunlight or rain, near heaters or other hot appliances, in any location exposed to extremely high or low temperatures (e.g., on the dashboard or in the back of your car) or high humidity, or in dusty locations.
- Do not apply excessive pressure to the cutter lever.
- Do not try to print if the cassette is empty; it will damage the print head.
- Do not pull the tape while printing or feeding; it will damage the tape and the P-touch ribbon/tape printer.
- Any data stored in memory will be lost due to failure, repair of the P-touch ribbon/tape printer, or if the battery expires.
- The P-touch ribbon/tape printer is not equipped with a charging feature for rechargeable batteries.
- The printed text may differ from the text that appears on the LCD.
- The length of the printed ribbon/tape may differ from the displayed label length.
- A protective clear plastic sticker is placed over the display during manufacturing and shipping. This sticker should be removed prior to use.
- When power is disconnected for more than three minutes, all text, format settings and any text files stored in the memory will be cleared.

### Federal Communications Commission (FCC) Compliance Notice (For USA Only)

This equipment has been tested and found to comply with the limits for a Class B digital device, pursuant to Part 15 of the FCC Rules. These limits are designed to provide reasonable protection against harmful interference in a residential installation. This equipment generates, uses, and can radiate radio frequency energy and, if not installed and used in accordance with the instructions, may cause harmful interference to radio communications. However, there is no guarantee that interference will not occur in a particular installation. If this equipment does cause harmful interference to radio or television reception, which can be determined by turning the equipment off and on, the user is encouraged to try to correct the interference by one or more of the following measures:

- Reorient or relocate the receiving antenna
- Increase the separation between the equipment and receiver.
- Connect the equipment into an outlet on a circuit different from that to which the receiver is connected.
- Consult the dealer or an experienced radio / TV technician for help.

#### Important

Changes or modifications not expressly approved by Brother Industries, Ltd. could void the user's authority to operate the equipment.

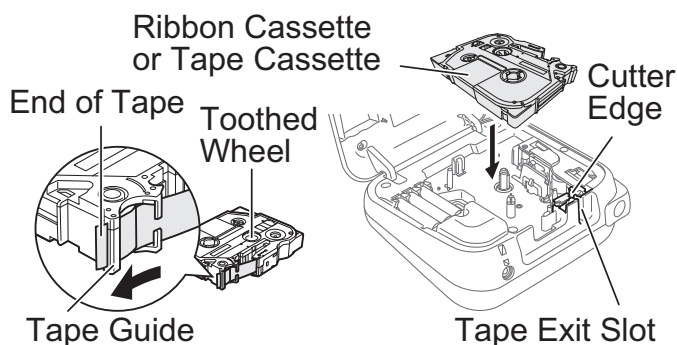

**Insert the Ribbon or Tape Cassette following the drawing marked inside the case. Gently press the Cassette into the ribbon/tape printer until it clicks into place.**

- Make sure your Ribbon or Tape Cassette is marked **TZe**.
- Use only tape widths of 3.5 mm, 6 mm, 9 mm, or 12 mm.
- If your TZe is packaged with protective plastic, be sure to remove the plastic before inserting the tape cassette.
- Use only Brother TZe tapes with this machine.

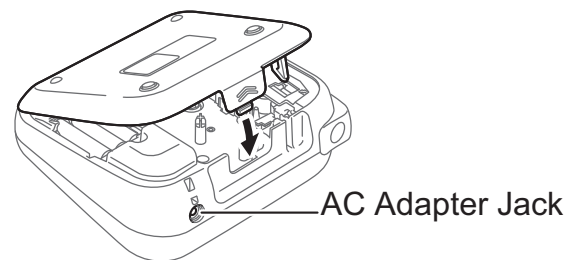

**Close the Cassette Cover and gently press until it clicks into place.**

#### NOTE

If you prefer to use the optional AC Adapter (AD-24ESA) instead of using batteries:

1. Insert the Power Adapter cord into the AC Adapter Jack on the side of the machine.
2. Insert the Power Adapter into a grounded AC electrical outlet.

*When running a memory backup, we recommend using both batteries AND the optional Power Adapter, in the event that one or the other power method fails.*

# LCD and Keyboard

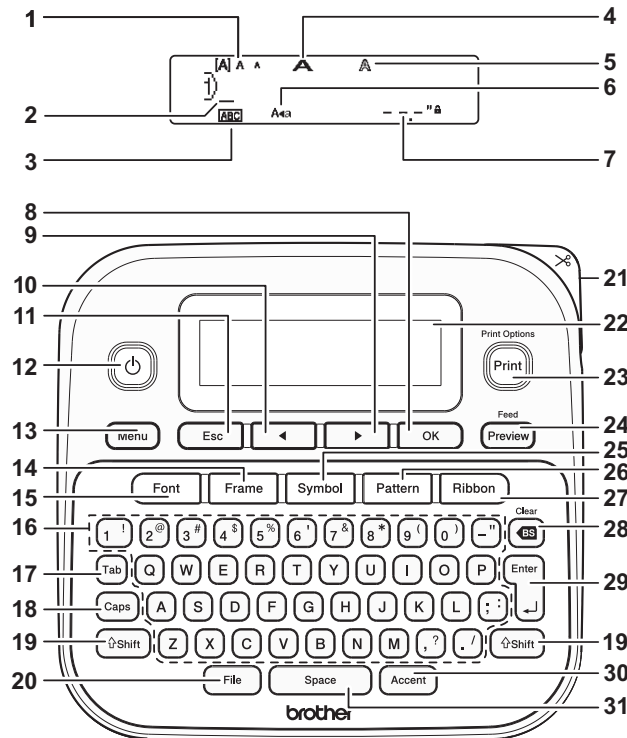

- |                       |                       |
|-----------------------|-----------------------|
| 1. Size               | 15. Font key          |
| 2. Cursor             | 16. Character key     |
| 3. Underline / Frame  | 17. Tab key           |
| 4. Width              | 18. Caps key          |
| 5. Style              | 19. Shift key         |
| 6. Caps               | 20. File key          |
| 7. Ribbon/Tape Length | 21. Tape cutter lever |
| 8. OK key             | 22. LCD               |
| 9. Cursor key : Right | 23. Print key         |
| 10. Cursor key : Left | 24. Preview key       |
| 11. Escape key        | 25. Symbol key        |
| 12. Power key         | 26. Pattern key       |
| 13. Menu key          | 27. Ribbon key        |
| 14. Frame key         | 28. Backspace key     |
|                       | 29. Enter key         |
|                       | 30. Accent key        |
|                       | 31. Space key         |

## NOTE

- The LCD displays one row of 15 characters; however, there is a maximum of 80 characters and spaces for a text label, and 50 characters and spaces if using templates.
- When selecting the settings, press  to return to the default item.

- Pressing the Preview key (24) displays a preview of the ribbon/tape, and may differ from the actual ribbon/tape when printed.
- Ribbon/Tape length shown on the LCD may differ slightly from the actual length when printed.

## Specifications

<b>Dimensions:</b> (W x D x H)	Approx. 6.2" X 5.9" X 2.7" (Approx. 157(W) x 150(D) x 68(H)mm)
<b>Weight:</b>	Approx. 1.1 lb. (Approx. 490 g) (without batteries and cassette)
<b>Power Supply:</b>	Six AAA alkaline batteries (LR03) Six AAA Ni-MH batteries (HR03) Optional AC Adapter (AD-24ESA)
<b>Tape Cassette:</b>	Brother TZe tape (width) 0.13" (3.5mm), 0.23" (6mm), 0.35" (9mm), 0.47" (12mm)
<b>Ribbon Cassette:</b>	Brother TZe ribbon (width) 0.47" (12mm)
<b>Pattern Tape Cassette:</b>	Brother TZe tape (width) 0.47" (12mm)

For FAQs, Troubleshooting, and to download software and manuals, visit: [support.brother.com](http://support.brother.com).

## Initial Settings

- 1 Turn your machine on.**  
Supply power by using six AAA batteries or the optional AC Adapter, and then press .



- 2 Set the language.**  
The default setting is [English].

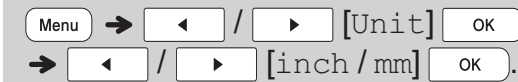

- 3 Set the unit of measurement.**  
The default setting is [inch].



### NOTE

- The machine automatically turns off if no keys are pressed within five minutes.
- To cancel any operation, press .
- After pressing , [Accepted] appears for approximately one second.

## Contrast

This function allows you to set the brightness of the LCD display. You can select from five levels of brightness. The default setting is [0].

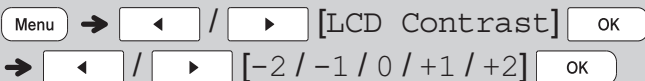

- To return to the default setting, press .

## Supplies and Accessories

- Cassettes:** See the included *Supplies and Accessories Guide*.
- AC Adapter:** AD-24ESA
- Cutter Unit:** TC-4 (replacement)

Over time, the Cutter Blade may become blunt from repetitive use. If the Cutter does not cut tape cleanly, replace the Cutter Unit. Contact your local authorized Brother reseller and order item TC-4, the Cutter Unit.

### ▶ Replacing the Cutter Unit

1. Remove the two sections of the Cutter Unit (green) in the direction of the arrows as illustrated below ①.
2. Install a new Cutter Unit. Push it in gently until it snaps into place.

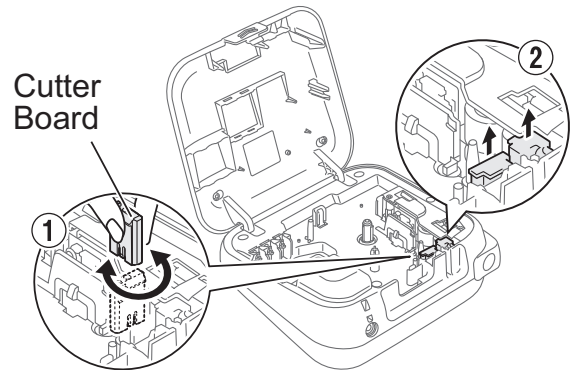

### ⚠ WARNING

Do not touch the cutter blade directly with your fingers.

## 2 BASIC USAGE

### Entering Text

You can enter a maximum of 80 characters and spaces for a text label, and 50 characters and spaces if using templates.

To cancel any operation, press **Esc**.

After pressing **OK**, [Accepted] appears on the LCD for approximately one second.

#### Switching Upper Case / Lower Case

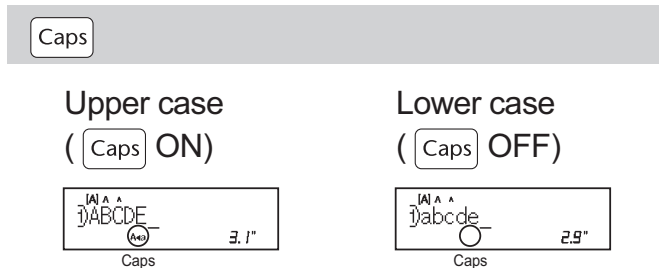

#### Creating Two-Line Ribbons / Tapes

Move the cursor to where you want to start the next line and press **Enter**. Use either 0.35" (9mm) or 0.47" (12mm) tape for two-line printing.

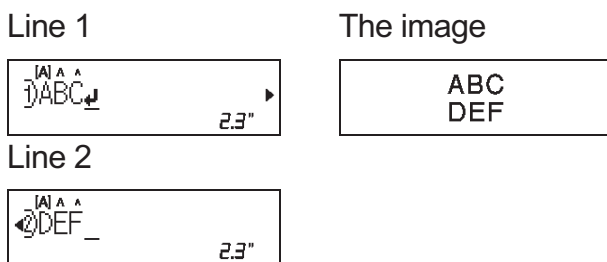

#### NOTE

- The return symbol (**↵**) appears when you press the Enter key.

#### Entering Tabs



- The tab symbol **␣** appears when you insert a tab in the text.

#### Changing Tab Length

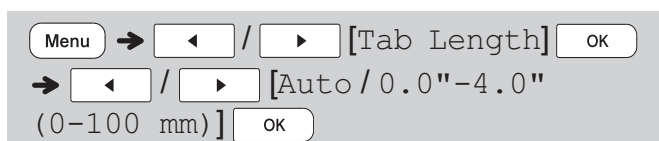

- To return to the default tab length, press **Space**.
- Please note : the default length varies based on your ribbon or tape size.

#### Cursor Keys

To move to the end of your text:



To move to the beginning of your text:



#### Entering Accented Characters



- Refer to the **Accented Characters** table in this guide.
- The order of accented characters varies based on the language you selected.

#### Changing Ribbon / Tape Length



#### NOTE

- After printing a ribbon, cut along the printed dots (:) with scissors so the ribbon length matches what is shown on the LCD.
- The lock symbol **🔒** appears when you set a specific ribbon/tape length.
- To return to the default length (automatic, based on text length), press **Space**, and [Auto] appears on the LCD.

#### Clearing Text and Settings

To delete individual letters and spaces, press **BS**.  
To delete all text :



To delete all text and settings :





# Printing Ribbons / Tapes

## ► Preview

Preview

- Pressing the Preview key displays a preview of the ribbon/tape, and may differ from the actual one when printed.
- If the LCD cannot display all the text at once, press / to display the hidden text.
- Press / / to exit Preview mode.

## ► Feeding (Tape Feed)

+

- This function feeds approximately 1" (25mm) of blank tape.
- Do not pull the tape, as this may damage the Tape Cassette.

## ► Printing

→ [Copies: ] / / 1 - 9 (

- If you need only one copy of the ribbon/tape, press after you press .
- You can print up to nine copies of each ribbon/tape.
- Press a number key to specify the number of copies you wish to print.
- DO NOT touch the Tape Cutter Lever while the message [Please Wait] appears on the LCD.
- **To cut tape:** When printing ends, push the Tape Cutter Lever after the message [Please Cut] appears.
- **To cut ribbon:** When printing ends, press + to feed the ribbon, and then cut with scissors.
- To remove tape backing, fold the ribbon/tape lengthwise (with the text facing inward), to expose the inside edges that run down the center of the tape backing. Peel and apply.

## ► Using Print Options

+

### [Numbering]

You can print a series of up to nine ribbons/tapes using auto-numbering. Use this feature to automatically increase a selected number by 1 after each one is printed.

**Ex:** Print copies of a ribbon/tape containing a serial number (0123, 0124 and 0125)

(Enter numbers) → / by moving the cursor to the number you wish to

increment. → + →

/ [Numbering] →

/ Set 3-5

- Select the highest number you wish to print when setting the number.

### [Mirror]

**Ex:** To Mirror Print "J.SMITH", follow the instructions below after entering "J.SMITH".

J.SMITH

(Enter text or characters) → + →

/ [Mirror] → [Mirror Print?]

- Use clear tape when using this function, so the labels can be read correctly from the opposite side when attached on glass, windows, or other transparent surfaces.

## Printing Ribbons / Tapes (cont)

### ► Setting Margins



#### [Full] / [Half] / [Narrow]



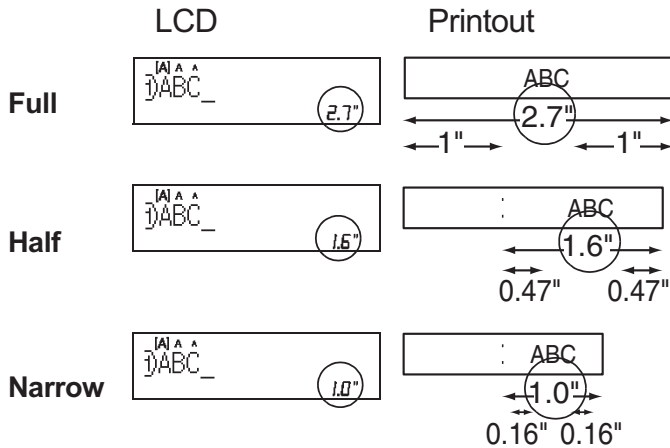

Use one of these options to customize margin length before and after your text.

- The printed dots (:) indicate the end of the label. Cut along the printed dots (:) with scissors.





#### [Chain Print] (ribbon/tape-saving option)

Use this option to print multiple different labels with narrow margins. This option saves ribbon/tape.

1. Enter your text.
2. Press . [Copies] appears on the LCD.
3. Press the number keys to enter the number of copies you want of this text.
4. Press  to start printing.
5. When [Feed OK?] appears on the LCD, press  to change the text.
6. Clear the text, enter the text you want on the next ribbon/tape, and then press .
7. After your last ribbon/tape prints, when [Feed OK?] appears on the LCD, press .

### ● NOTE

- When you use [Chain Print], feed the ribbon/tape before using the cutter ( + ), otherwise part of the text may be cut off.
- Do not pull the tape, as this may damage the Tape Cassette.
- The printed dots (:) indicate the end of the label. Cut along the printed dots (:) with scissors.



## Saving Ribbons / Tapes Files

You can save and reuse the text and settings for up to 20 different labels. Each ribbon/tape holds up to 80 characters (including spaces). Assign a number (1-20) to each saved file so you can reuse it, and edit or overwrite stored files as needed.

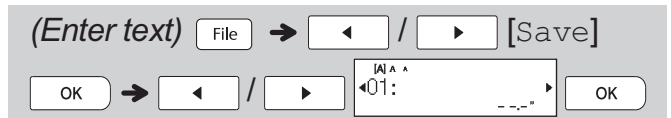
### ► Saving a new file



### ● NOTE

- When saving a file, if you reuse a number that is already assigned to another file, [Overwrite OK?] appears on the LCD. To overwrite the previously-saved file, press . To cancel without saving, press .

### ► Printing a saved file

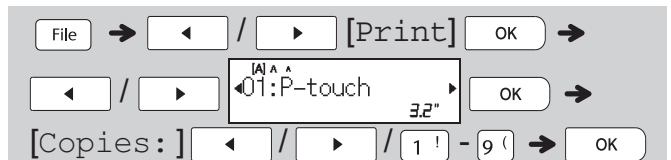

### ► Opening a saved file





### 3 USING TEMPLATES

#### Text

Use Text templates to repeat text without having to retype it. Enter your own text or use the built-in two-line Text templates. Refer to the **Text Samples** table in this guide.

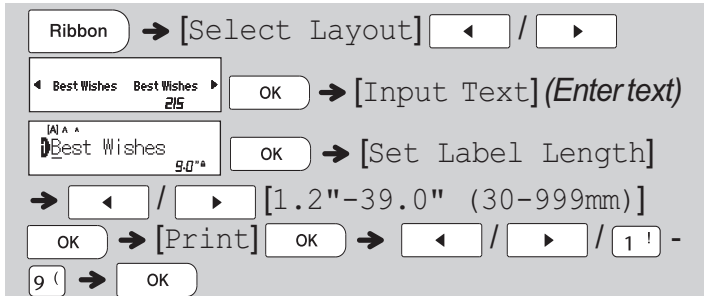

#### NOTE

- Press **Font** to select font, size, and style after entering your text.
- Press **Frame** to select a frame after entering your text.

#### Initial Marks

Use Initial Marks to add personality to your ribbons/tapes. Refer to the **Initial Marks** table in this guide.

Ex.: 

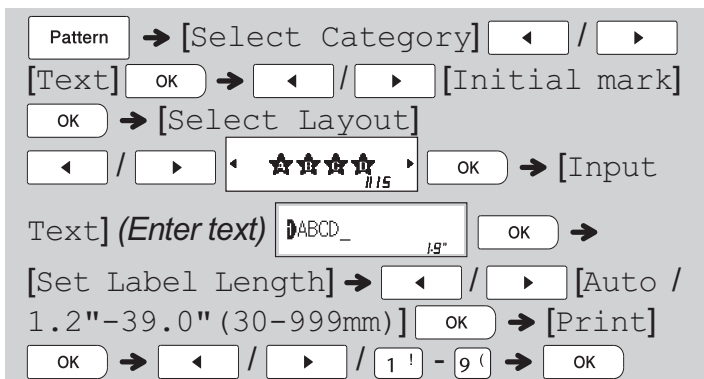

#### Continuous Frame

Use Continuous Frame to create upper and lower borders on ribbons/tapes. Refer to the **Continuous Frame** table in this guide.

Ex.: 

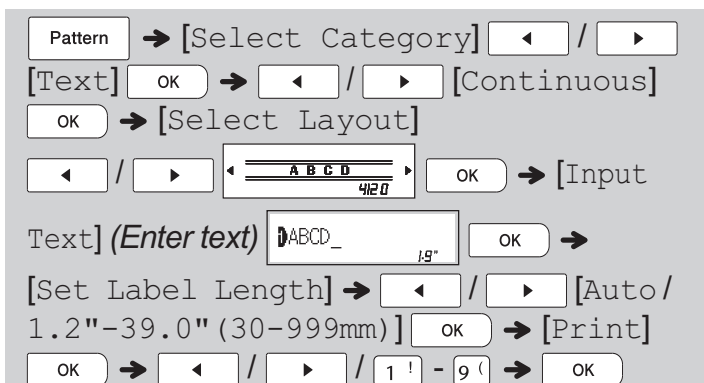

#### Patterns

Use Patterns to add visual texture to your ribbons/tapes. Please note that you cannot enter text when using Patterns. Refer to the **Patterns** table in this guide.

Ex.: 

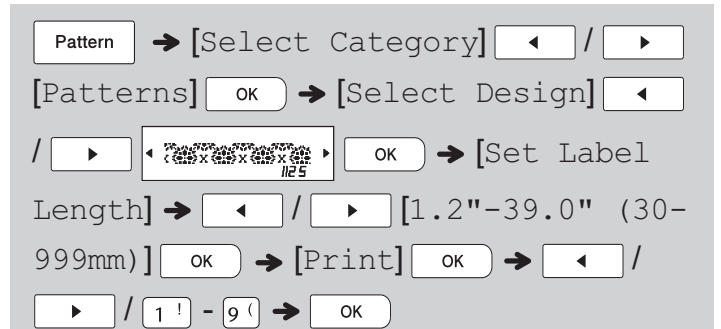

#### NOTE

##### ► For Initial Marks and Continuous Frame

- To preview ribbons/tapes, press **Preview** when **[Print]** is displayed on the LCD.
- If you set the label length to longer than the default length (**[AUTO]**), the text prints repeatedly within the length you set. If the text length exceeds the label length you have set, text may not print completely.
- The available label length setting changes depending on the length of your text.
- Press **Font** to select font after entering your text (for Continuous Frame templates, you can select size and style, also).

##### ► For Patterns

- Press **Space** to return to the default setting (**[3.9" (100mm)]**) for **[Label Length]**.

##### ► For All Templates

- Templates can be used **ONLY** with 0.47"(12mm) tape cassettes.
- Templates cannot be edited.
- To exit a template and return to the text entry screen, press **Esc** when **[Print]** appears on the LCD.
- Ribbon/tape files created using templates cannot be saved.
- When you access templates, your most recent label created with a template opens automatically.
- After pressing **OK**, **[Please Cut]** appears on the LCD for two seconds.

## 4 FORMATTING KEYS

### Font Key

Font

1 Press **Font** to change the font settings.

Font → ◀ / ▶ (Select an item)

OK

2 Press ◀ / ▶ to select the settings you want, and then press **OK**.

Font	A A	Helsinki	A 1
		Atlanta	A 1
		Brussels	A 1
		US	A 1
		Belgium	A 1
		Adams	A 1
		San Diego	A 1
		Florida	A 1
		Istanbul	A 1
		Sofia	A 1
		Bolivia	A 1
		Calgary	A 1
		Berlin	A 1
		Venezia	A 1
Size	A A A	Large	A
		Medium	A
		Small	A
Width	A A	Normal	A
		× 2	A
		× 1/2	A

Style	A A	Normal	A
		Bold	A
		Outline	A
		Shadow	A
		Solid	A
		Italic	A
		I+Bold	A
		I+Outline	A
		I+Shadow	A
Vertical	A		
Alignment	=	Left	=
		Center	≠
		Right	=
		Justify	≡

#### NOTE

- Refer to the **Font Samples** table illustrated in this guide.
- The actual printed font size depends on the tape width, number of characters and number of input lines. Once characters reach a minimum size, the selected font will default to a custom font which is based on the Helsinki style. This allows ribbons/tapes to be printed using the smallest text possible on narrow or multi-line ribbon and tapes.

## Frame Key

Frame

Press **Frame** to select the frame design. Refer to the **Frame Designs** table section in this guide.

Frame → ◀ / ▶ / 1 ! - 9 { (Select a frame) OK

### NOTE

- To cancel operations, press **Esc**.
- If the message **0.47" TAPE** (**12mm TAPE**) appears on the right side of the LCD when selecting a frame, it means that frame is available only when using 0.47" (12mm) cassettes.
- Select the Frame Design template by pressing the number key of the Frame Design you want. Refer to the **Frame Designs** table section in this guide.

## Symbol Key

Symbol

Press **Symbol** to select various symbols. Refer to the **Basic Symbols** and **Pictograph Symbols** table sections in this guide.

Symbol → ◀ / ▶ [History / Basic / Pictograph] OK → ◀ / ▶ (Select category) OK → ◀ / ▶ (Choose a symbol) OK

### NOTE

- Once you select symbols, up to seven recently used symbols are added to History.
- If you choose History, you cannot select the category.
- You can also select from the Basic Symbols and Pictograph Symbols categories by pressing the shortcut keys under (5) **Helpful Hints, Shortcuts**.

### ► Basic

Punctuation	Space	Fractions	(E)
Mathematics	(A)	Roman Numerals	(F)
Brackets	(B)	Shapes	(G)
Arrows	(C)	Number	(H)
Unit	(D)		

### ► Pictograph

Emojis	Space	Events	(I)
Music	(A)	Kitchen	(J)
Clothes	(B)	Food & Bev	(K)
Travel	(C)	Crafts	(L)
Sports	(D)	Baby	(M)
Animals	(E)	School	(N)
Decorative	(F)	Home Office	(O)
Astrology	(G)	Audio Visual	(P)
Holiday	(H)		

## 5 HELPFUL HINTS

### Shortcuts

File	Menu → 1 !
Tab	Menu → 2 @
Unit	Menu → 3 #
LCD Contrast	Menu → 4 \$
Ribbon/Tape Length	Menu → 5 %
Margin	Menu → 6 '
Tab Length	Menu → 7 &
Clear	Menu → BS
Language	Menu → Space

### Helpful Tips

Clear	⇧Shift → BS
Feed	⇧Shift → Preview
Print Options	⇧Shift → Print

### Resetting the P-touch

Reset your P-touch ribbon/tape printer when you want to initialize the settings, or in the event it is not working properly. Resetting clears all the text, settings, and stored files.

- 1 Turn off the P-touch ribbon/tape printer, hold down ⇧Shift and R, and then press  to turn the P-touch ribbon/tape printer back on.
- 2 First release the power button, and then release ⇧Shift and R.

The P-touch ribbon/tape printer turns on with the internal memory reset.

If you have questions or need information about your Brother product, please visit us online or call.

For FAQs, Troubleshooting, and to download software and manuals, visit [support.brother.com](http://support.brother.com).

To order supplies and accessories, visit [www.brothermall.com](http://www.brothermall.com) or call 1-877-552-6255.

For USA Customer Service, call 1-877-BROTHER (1-877-276-8437)  
Fax: 1-901-379-1210

### ⚠ CAUTION

USING A COMBINATION OF DIFFERENT BATTERIES (SUCH AS ALKALINE WITH Ni-MH), MAY RESULT IN AN EXPLOSION. DISPOSE OF USED BATTERIES ACCORDING TO THE INSTRUCTIONS.

### ● NOTE

- Remove the batteries if you do not intend to use the ribbon/tape printer for an extended period of time.
- Dispose of batteries at an appropriate collection point, not in the general waste stream. Be sure to observe all applicable federal, state, and local regulations.
- When storing or discarding a battery, wrap it with cellophane tape to prevent it from short-circuiting. (see illustration)



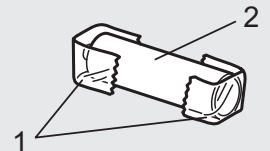





1. Cellophane tape
2. Alkaline or Ni-MH battery

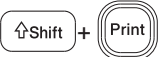







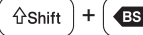

*Do not mix old and new batteries. Replace all six batteries at the same time.*

# Troubleshooting

## ► Error messages

Message	Cause / Remedy
Battery Low!	The batteries are weak. If using AAA alkaline batteries, replace them with new ones. If using Ni-MH batteries, charge them fully.
Battery Empty!	The installed batteries are running low and need to be replaced for continued operation.
Invalid!	<ul style="list-style-type: none"> <li>There is no text above the cursor when you selected [Numbering].</li> <li>An invalid character was selected for [Numbering].</li> <li>An invalid value was selected for [Tab Length] or [Label Length].</li> <li>An invalid value was entered as the ribbon/tape length while using templates.</li> </ul>
No Text!	<ul style="list-style-type: none"> <li>You tried to print a text file when there is no data stored in the memory.</li> <li> is pressed when no text is entered.</li> <li> is pressed when no text is entered.</li> <li> is pressed when no text is entered.</li> <li> or  was pressed when no text was entered while using templates.</li> </ul>
2 Line Limit!/ 1 Line Limit!	<ul style="list-style-type: none"> <li>You tried to enter a 3rd line by pressing .</li> <li>You tried to print or preview two lines of text while 0.13" (3.5mm) or 0.23" (6 mm) tape is installed. Install a larger tape size.</li> </ul>
No Cassette!	There is no cassette installed.
Cutter Pressed	The Tape Cutter Lever was pressed in the middle of the printing process.
Text Full!	The maximum number of characters (80 characters for text, 50 characters for templates) have already been entered.
Change Length	You may have exceeded ribbon/tape length. Reduce the text or select [Auto] as the ribbon/tape length.
No Frame OK?	<ul style="list-style-type: none"> <li>You have used a frame or Frame settings are ON, but a cassette narrower than 0.47"(12mm) is installed (Frames for use ONLY with 0.47"(12mm) cassettes).</li> <li>Select  to print with no Frame, press  to cancel.</li> </ul>
Feed OK?	Feeding tape after printing when [Chain Print] is selected. Refer to the <b>Setting Margin</b> section in this guide.
Insert 0.47"	Make sure you are using a 0.47"(12mm) cassette.
Use TZe Tape!	Use a cassette with the  mark.

## ► What to do when...

Problem	Solution
The display stays blank after you have turned on the machine.	<ul style="list-style-type: none"> <li>Check that the batteries are correctly inserted.</li> <li>The batteries may be weak. Replace them.</li> <li>Check that the AD-24ESA adapter is correctly connected.</li> </ul>
When the ribbon/tape is printed out, there is too much margin (space) on both sides of the text.	<ul style="list-style-type: none"> <li>Refer to the <b>Setting Margin</b> section in this guide and select [Half], [Narrow] or [Chain] to have smaller margins for your ribbon/tape.</li> </ul>
The machine does not print, or the printed characters are not formed properly.	<ul style="list-style-type: none"> <li>Check that the cassette is inserted correctly.</li> <li>If the cassette is empty, replace it.</li> <li>Check the Tape Cassette Cover is closed correctly.</li> </ul>
The setting has cleared on its own.	<ul style="list-style-type: none"> <li>The batteries may be weak. Replace them.</li> <li>When power is disconnected for more than three minutes, all text and formats in the display settings are cleared.</li> </ul>
A blank horizontal line appears through the printed ribbon/tape.	<ul style="list-style-type: none"> <li>There may be some dust on the Print Head. Remove the cassette and use a dry cotton swab to gently wipe the Print Head with an up-and-down motion.</li> </ul>
The machine has "locked up" (i.e., nothing happens when a key is pressed, even though the machine is on.)	<ul style="list-style-type: none"> <li>Refer to the <b>Resetting the P-Touch</b> section in this guide.</li> </ul>
The power turns off when you try to print.	<ul style="list-style-type: none"> <li>The batteries may be weak. Replace them.</li> <li>Check that the batteries are correctly inserted.</li> <li>The wrong AC Adapter is used. We recommend using the AD-24ESA Adapter.</li> </ul>
The tape does not feed properly or the tape gets stuck inside the machine.	<ul style="list-style-type: none"> <li>Check that the end of the tape feeds under the tape guides.</li> <li>The Cutter Lever is pressed while printing. Do not touch the Cutter Lever during printing.</li> </ul>
All text and format settings need to be cleared to create a new ribbon/tape.	<ul style="list-style-type: none"> <li>Press  and select [Text&amp;Format].</li> <li>Press  →  /  [Clear]</li> <li> →  / </li> <li>[Text&amp;Format] </li> </ul>
To change language setting.	<ul style="list-style-type: none"> <li>Refer to the <b>Initial Settings</b> section in this guide.</li> </ul>





Patterns					
01		10		19	
02		11		20	
03		12		21	
04		13		22	
05		14		23	
06		15		24	
07		16		25	
08		17			
09		18			

Continuous Frame					
01	ABCD ABCD	08	ABCD ABCD	15	ABCD ABCD
02	ABCD ABCD	09	ABCD ABCD	16	ABCD ABCD
03	ABCD ABCD	10	ABCD ABCD	17	ABCD ABCD
04	ABCD ABCD	11	ABCD ABCD	18	ABCD ABCD
05	ABCD ABCD	12	ABCD ABCD	19	ABCD ABCD
06	ABCD ABCD	13	ABCD ABCD	20	ABCD ABCD
07	ABCD ABCD	14	ABCD ABCD		

Accented Characters					
A	Á Â Ã Ä Å Æ Æ Æ Æ Æ	a	á à â ã ä å æ ã ç å ā ã		
C	Ç Ć Ć Ć Ć Ć Ć Ć	D	Đ Đ Đ Đ Đ Đ Đ Đ Đ	c	ç ċ ċ ċ ċ ċ ċ ċ ċ ċ
E	É È Ê Ë Ì Í Î Ï Ñ Ñ Ñ Ñ Ñ	e	é è ê ë ě ě ě ě ě ě ě	d	d' ð ð ð ð ð ð ð ð ð
G	Ğ Ğ Ğ Ğ Ğ Ğ Ğ Ğ Ğ Ğ	g	ğ ğ ğ ğ ğ ğ ğ ğ ğ ğ	i	í î ï ï ï ï ï ï ï ï ï
K	Ķ Ķ Ķ Ķ Ķ Ķ Ķ Ķ Ķ	k	ķ ķ ķ ķ ķ ķ ķ ķ ķ ķ	l	ł ł ł ł ł ł ł ł ł ł
N	Ñ Ñ Ñ Ñ Ñ Ñ Ñ Ñ Ñ	n	ñ ñ ñ ñ ñ ñ ñ ñ ñ ñ	r	ř ř ř ř ř ř ř ř ř ř
O	Ó Ò Ô Ø Ö Õ Œ Õ	o	ó ò ô ø ö õ œ õ		
S	Š Š Š Š Š Š Š Š Š Š	s	š š š š š š š š š š	t	t' † † † † † † † † †
U	Ú Û Ü Ů Ů Ů Ů Ů Ů Ů	u	ú ù û ü ů ů ů ů ů ů ů		
Y	Ý Ÿ Ÿ Ÿ Ÿ Ÿ Ÿ Ÿ Ÿ Ÿ	y	ý ŷ ŷ ŷ ŷ ŷ ŷ ŷ ŷ ŷ	z	ž ž ž ž ž ž ž ž ž ž

Font Samples

Helsinki	ABC\$£€39	Florida	<b>ABC\$£€39</b>
Atlanta	ABC\$£€39	Istanbul	<b>ABC\$£€39</b>
Brussels	ABC\$£€39	Sofia	<b>ABC\$£€39</b>
US	ABC\$£€39	Bolivia	ABC\$£€39
Belgium	ABC\$£€39	Calgary	<i>ABC\$£€39</i>
Adams	ABC\$£€39	Berlin	<i>ABC\$£€39</i>
San Diego	<b>ABC\$£€39</b>	Venezia	<b>ABC\$£€39</b>

Initial Marks

01		06		11	
02		07		12	
03		08		13	
04		09		14	
05		10		15	











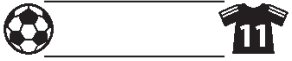





















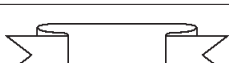
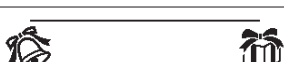
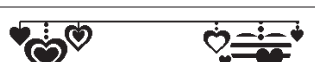
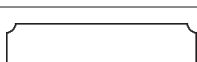
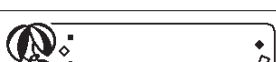
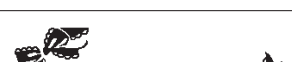
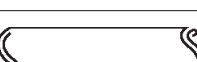
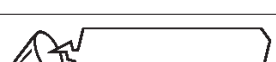
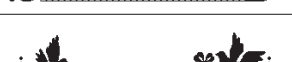
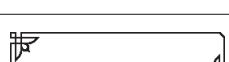

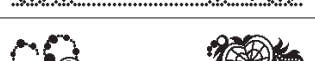

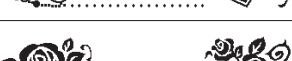
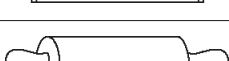
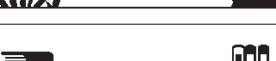
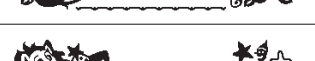
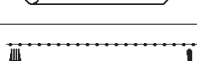
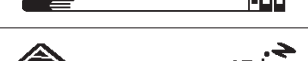

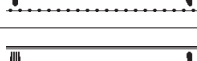
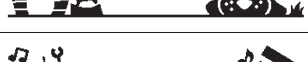
Frame Designs \*

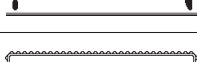
01	Off	11		21	
02	12345	12		22	
03		13		23	
04		14		24	
05		15		25	
06		16		26	
07		17		27	
08		18		28	
09		19		29	
10		20		30	

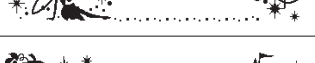
Note: Images are for illustrative purposes only.

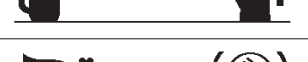
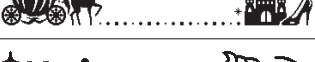
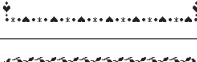
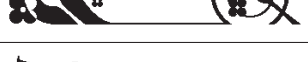
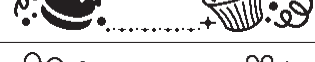
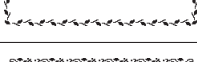
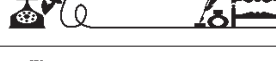
\* Not applicable Frame Designs with numbers highlighted in gray can be used ONLY with 0.47"(12mm) wide tape cassettes.

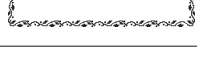
Frame Designs \*

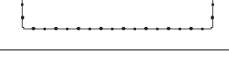
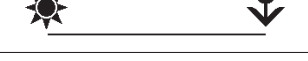
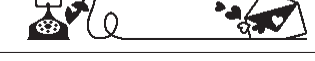
31		53		75	
32		54		76	
33		55		77	
34		56		78	
35		57		79	
36		58		80	
37		59		81	
38		60		82	
39		61		83	
40		62		84	
41		63		85	
42		64		86	
43		65		87	
44		66		88	
45		67		89	
46		68		90	
47		69		91	
48		70		92	
49		71		93	
50		72		94	
51		73		95	
52		74		96	