

Innov-ís

DISNEY DESIGN GUIDE
GUIDE DE MODELES DISNEY
DISNEY-DESIGNANLEITUNG
DISNEY ONTWERPENGLIDS
GUÍA DE DISEÑO DISNEY
GUIDA AI DISEGNI DISNEY

Disney

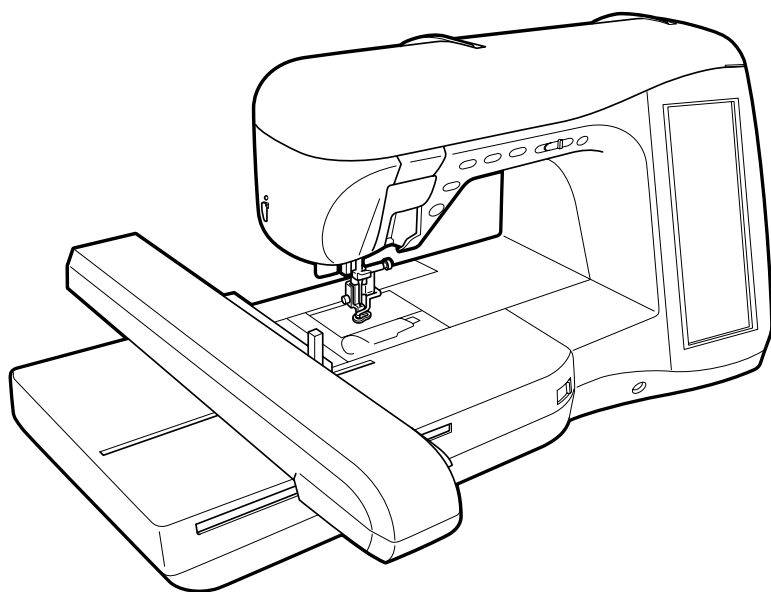

©Disney

brother®
at your side

WARNING
WARNUNG
ADVERTENCIA

AVERTISSEMENT
WAARSCHUWING
AVVERTIMENTO

The embroidery patterns contained in this product are for personal non-commercial use only. No license is granted for any commercial use of these patterns and any such use is strictly prohibited.

Les motifs de broderie contenus dans ce produit sont exclusivement destinés à une utilisation personnelle non commerciale. Aucune licence n'est accordée en vue d'une utilisation commerciale de ces motifs, qui est strictement interdite.

Die in diesem Produkt enthaltenen Stickdesigns sind nur für den persönlichen, nicht-kommerziellen Bedarf. Für die kommerzielle Nutzung dieser Stickdesigns wird keine Lizenz gewährt und jegliche kommerzielle Nutzung ist strengstens untersagt.

De borduurpatronen in dit product zijn uitsluitend bedoeld voor niet-commercieel privégebruik. Er wordt geen licentie verstrekt voor commercieel gebruik van deze patronen. Dergelijk gebruik is ten strengste verboden.

Los patrones de bordado incluidos en este producto son exclusivamente para uso personal no comercial. No se concede licencia para uso comercial de estos patrones y dicho uso queda estrictamente prohibido.

I motivi di ricamo contenuti in questo prodotto sono solo per uso personale, non commerciale. Non si concede alcuna licenza per l'eventuale uso commerciale di questi motivi e qualsiasi uso di questo tipo è severamente vietato.

Refer to the operation manual for detailed instruction.

Also, there are differences in the keys and screens depending on the display language. In this guide, English screens are used for basic explanations.

Pour les instructions détaillées, voir le manuel d'instructions.

Par ailleurs, il y a des différences dans les touches et les écrans en fonction de la langue d'affichage.

Dans ce guide, les explications de base utilisent les écrans anglais.

Einzelheiten entnehmen Sie bitte der Bedienungsanleitung.

Je nachdem, welche Sprache für die Bildschirmanzeigen gewählt wurde, ergeben sich im Hinblick auf Tasten Schirmbilder eventuell Unterschiede.

Die grundlegende Bedienung der Maschine ist in dieser Anleitung am Beispiel von Schirmbildern mit englischem Text erklärt.

Zie de bedieningshandleiding voor gedetailleerde instructies.

Er zijn verschillen in de toetsen en schermen afhankelijk van de ingestelde taal.

In de beschrijvingen in deze beknopte handleiding worden de Engelse schermen gebruikt.

Consulte el manual de instrucciones para ver más detalles.

Además, dependiendo del idioma visualizado algunos botones y pantallas podrán ser diferentes.

En esta guía, para las explicaciones básicas se emplean pantallas en inglés.

Fara riferimento al manuale d'istruzioni per istruzioni dettagliate.

Inoltre, ci sono differenze nei tasti e nelle schermate a seconda della lingua visualizzata.

In questa guida, le schermate in inglese sono usate per le spiegazioni basilari.

Before Use
Vor der Inbetriebnahme
Antes de usar

Avant l'utilisation
Alvorens te gebruiken
Prima dell'uso

When this unit's power is turned on, the screen will display Disney opening screen. Touch the display to move on to further machine functions.

Lorsque cette machine est mise sous tension, une scène représentant Pooh et ses amis s'affiche en continu. Pour passer à l'affichage des fonctions de la machine, effleurer l'affichage.

Wenn dieses Gerät eingeschaltet wird, erscheint eine Szene mit Pooh und seinen Freunden. Berühren Sie die Anzeige, um andere Funktionen zu bedienen.

Wanneer dit apparaat wordt ingeschakeld, wordt een scène getoond van Pooh en zijn vrienden. Druk op de display om door te gaan naar de overige machinefuncties.

Cuando sea encendida esta unidad, continuará viéndose una escena de Pooh y sus amigos. Toque la pantalla para cambiar a otras funciones de la máquina.

Quando questa unità viene accesa, rimane visualizzata una scena dell'orsetto Pooh con i suoi amici. Sfioccare il display per andare avanti sulle altre funzioni della macchina.

Selecting Disney characters
Einstellen von Disney-Charakter
Seleccionando a Disney.

Sélection des caractrés Disney.
Kiezen van Disney karakters
Selezione dei caratteri Disney

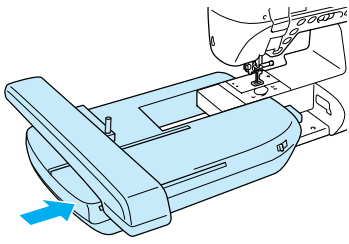



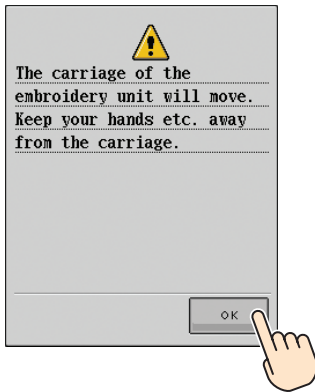

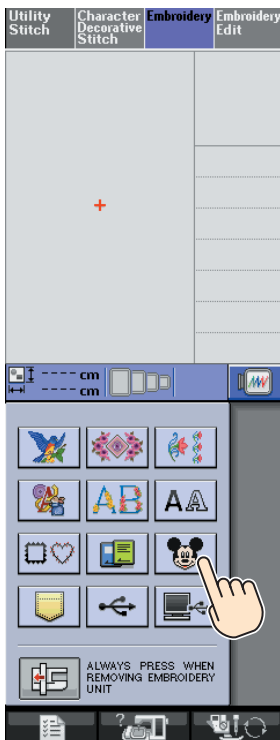

- 1** Turn off the power and make preparations for embroidery.
Mette la machine hors tension et effectuer les préparatifs pour la broderie.
Schalten Sie die Maschine aus und nehmen Sie die Vorbereitungen zum Sticken vor.
Schakel de machine uit en maak de voorbereidingen voor het borduurwerk.
Apague la alimentación y prepárese para bordar.
Spegner e l'unità ed eseguire i preparativi per il ricamo.
- Please see the machine's operation manual.
 - Se reporter au manuel d'instructions de la machine.
 - Dazu wird auf die Bedienungsanleitung der Nähmaschine verwiesen.
 - Zie de bedieningshandleiding van de machine.
 - Consulte el manual de instrucciones de la máquina.
 - Leggere il manuale d'istruzioni della macchina.



- 2** Turn on the power switch and touch the screen. The screen at left will be displayed.
Mette l'interrupteur d'alimentation sous tension et effleurer l'écran. L'écran de gauche s'affiche.
Schalten Sie den Netzschalter ein und berühren Sie die Bildschirmanzeige. Der linksstehende Bildschirm wird angezeigt.
Schakel de aan/uit schakelaar in en druk op het scherm. Het scherm links zal worden getoond.
Conecte el interruptor principal y toque la pantalla. Se exhibirá la pantalla a la izquierda.
Accendere l'interruttore di alimentazione e sfiorare lo schermo. Appare lo schermo a sinistra.





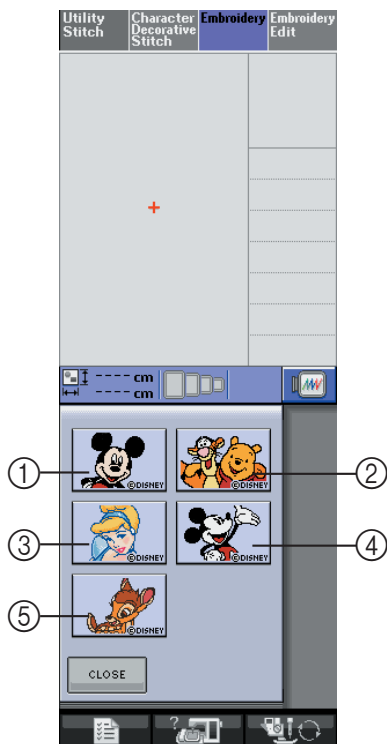



- 3** Press . The carriage of the embroidery unit will move to the initial setting position.
Effleurer . Le chariot de l'unité de broderie se place á la position du réglage initial.
Drücken Sie auf . Der Wagen der Stickereivorrichtung wird in die Ausgangsposition bewegt.
Druk op . De wagen van de borduureenheid zal naar de beginpositie verplaatst worden.
Toque . El carro de la unidad de bordado se moverá a la posición de ajuste inicial.
Sfiorare . Il carrello dell'unità di ricamo si sposta nella posizione di impostazione iniziale.
- 4** The pattern type selection screen will be displayed as shown at left. Press .
L'écran de sélection du motif s'affiche comme indiqué à gauche. Effleurer .
Der Musterart-Wahlbildschirm erscheint, wie in der Abbildung links gezeigt. Drücken Sie auf .
Het patroontype-keuzescherms verschijnt zoals links hiernaast is getoond. Druk op .
Se visualizará la pantalla de selección de tipo de diseño como se muestra a la izquierda. Toque .
La schermata di selezione del tipo di disegno viene visualizzata come mostrato a sinistra. Sfiore .



5 The Disney category screen will be displayed. Select the type of pattern.
 L'écran de la catégorie Disney s'affiche. Sélectionner le type du motif.
 Der Disney-Kategorie-Bildschirm wird angezeigt. Wählen Sie die Stickmusterart.
 Het Disney-categoriescherm verschijnt. Selecteer het type patroon.
 Se visualizará la pantalla de categoría Disney. Seleccione el tipo de patrón.
 Viene visualizzata la schermata della categoria Disney. Selezionare il tipo di disegno.

- ① Standard / Standard / Standard / Standaard / Normal / Moderno
- ② Pooh and friends / Pooh et ses amis / Pooh und Freunde / Poeh en zijn vrienden / Pooh y sus amigos / Pooh e amici
- ③ Princesses / Princesses / Prinzessinnen / Prinsessen / Princesas / Principesse
- ④ Vintage / Classique / Traditionell / Klassiek / Clásico / D'époque
- ⑤ Film property / Propriété du film / Filmrechte / Film-eigendom / Propiedad de la película / Proprietà film

6 Press .
 Effleurer .
 Drücken Sie auf .
 Druk op .
 Toque .
 Sfiurare .

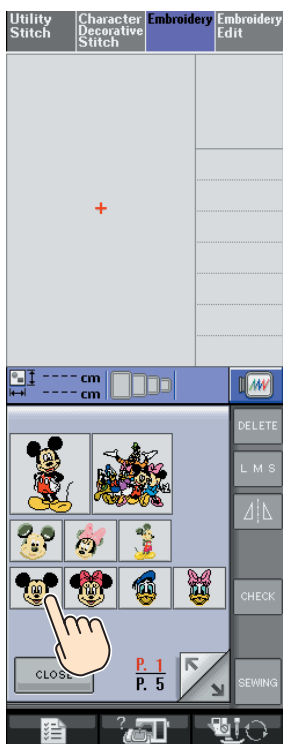

7 Select the desired pattern.
 Sélectionner le motif désiré.
 Wählen Sie das gewünschte Stickmuster.
 Selecteer het gewenste patroon.
 Seleccione el patrón deseado.
 Selezionare il disegno desiderato.

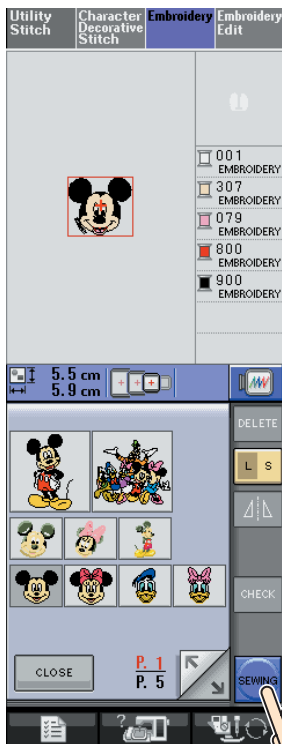

8 The selected pattern will be displayed in the top part of the screen.

Le motif sélectionné s'affiche en haut de l'écran.

Das eingestellte Stickmuster wird oben auf dem Bildschirm angezeigt.

Het geselecteerde patroon zal op het bovenste gedeelte van het scherm wordengetoond.

El patrón seleccionado se exhibirá en la parte superior de la pantalla.

Il disegno desiderato viene visualizzato nella parte superiore dello schermo.

- You can change the size of some patterns. If you would like to change the size of the pattern, press **L S** until the highlighted display matches the size you would like to select.
- La taille de certains motifs peut être changée. Pour changer la taille du motif, effleurer **L S** jusqu'à ce que l'affichage mis en valeur corresponde à la taille devant être sélectionnée.
- Die Größe von gewissen Mustern lässt sich einstellen. Drücken Sie zum Einstellen der Mustergröße auf **L S**, um die hervorgehobene Anzeige auf die gewünschte Größe einzustellen.
- U kunt het formaat van bepaalde patronen wijzigen. Als u het formaat van het patroon wilt wijzigen, op **L S** drukken totdat de verlichte display overeenkomt met het formaat dat u wilt selecteren.
- Puede cambiar el tamaño de algunos patrones. Si desea cambiar el tamaño del patrón, toque **L S** hasta que la exhibición destacada esté de acuerdo con el tamaño que desea seleccionar.
- È possibile cambiare la grandezza di alcuni disegni. Se si desidera cambiare la grandezza del disegno, sfiorare **L S** fino a che il display evidenziato corrisponde alla grandezza che si desidera selezionare.

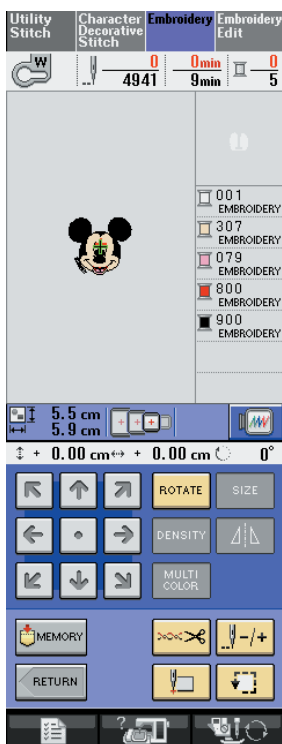

9 After making the selection, press **SEWING**.

Après avoir effectué la selection, effleurer **COUDRE**.

Drücken Sie nach der Auswahl auf **NAHEN**.

Druk na het maken van de selectie op **NAAIEN**.

Después de realizar la selección, toque **COSES**.

Dopo aver eseguito la selezione, sfiorare **CUCCIRI**.

10 The sewing screen will be displayed.

L'écran de broderie s'affiche.

Der Stickereibildschirm wird angezeigt.

Het borduurscherm zal worden getoond.

Se exhibirá la pantalla de bordado.

La schermata di ricamo viene visualizzata.

Color Change Table
Farbänderungstabelle
Tabla de cambio de color

Tableau des changements de couleur
Kleurveranderingstabel
Tabella di cambiamento colori

- The figures in shaded areas indicate the estimated time needed for the pattern to be embroidered. They do not include the time required to change and automatically trim threads.
- Les chiffres contenus dans les zones grisées indiquent le temps estimé nécessaire pour le motif à broder. Ils ne prennent pas en compte le temps nécessaire pour changer et couper automatiquement les fils.
- Die Angaben in den schattierten Feldern beziehen sich auf die voraussichtliche Zeit, die zum Sticken des Musters benötigt wird. In dieser Zeit ist das Wechseln und automatische Abschneiden der Fäden nicht eingeschlossen.
- De getallen in de gearceerde gedeelten geven bij benadering de tijd aan die voor het borduren van het patroon nodig is. Hierbij is de tijd die nodig is voor het verwisselen en automatisch afknippen van het garen niet inbegrepen.
- Los números sombreados indican el tiempo estimado necesario para bordar el patrón. No incluye el tiempo necesario para cambiar y recortar automáticamente los hilos.
- I numeri nelle parti tratteggiate indicano il tempo stimato necessario al ricamo del disegno. Essi non includono il tempo necessario a cambiare e tagliare automaticamente i fili.

Refer to the operation manual for details on how to embroider the pattern.
 Se reporter au manuel d'instructions pour les détails concernant la façon de broder le motif.
 Für das Sticken des Musters wird auf die Bedienungsanleitung verwiesen.
 Zie de bedieningshandleiding voor nadere bijzonderheden betreffende het borduren van het patroon.
 Consulte el manual de instrucciones por detalles sobre como bordar el patrón.
 Per i dettagli su come ricamare il disegno, far riferimento al manuale d'istruzioni.

Note: The Disney character patterns built into this unit cannot be resized or flipped.
 Remarque : Les motifs des personnages de Disney intégrés dans l'unité ne peuvent être ni redimensionnés ni orientés différemment.
 Hinweis: Die in dieser Einheit eingebauten Disney-Figuren können nicht in der Größe verändert oder umgedreht werden.
 Opmerking: De Disney-figuren die in deze borduureenheid zijn ingebouwd, kunnen niet van grootte worden veranderd of worden omgedraaid.
 Nota: Los diseños de personajes de Disney incorporados en esta unidad no podrán ser cambiados de tamaño ni darles la vuelta.
 Nota: I motivi con personaggi Disney inclusi in questa unità non possono essere ridimensionati o invertiti.

Patterns with ★ are embroidery patterns which use appliqués: No.71, No.93, No.94
 Les motifs marqués d'un ★ sont des motifs de broderie qui utilisent des appliqués : n° 71, n° 93, n° 94
 Muster mit ★ sind Stickmuster, die die folgenden Stickerei-Applikationen verwenden: Nr. 71, Nr. 93, Nr. 94
 Patronen met het ★ tekenje zijn borduurpatronen die appliqué gebruiken: Nr. 71, Nr. 93, Nr. 94
 Los diseños con ★ son diseños de bordados que se utilizan con apliques: N° 71, N° 93, N° 94
 I motivi contrassegnati da ★ sono motivi di ricamo che fanno uso di riporti: n. 71, n. 93 e n. 94

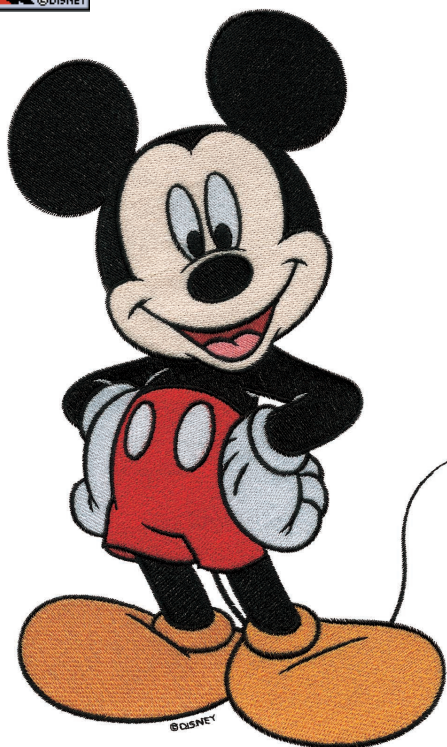

No.1 **92min**

1	(800)
2	(001)
3	(900)
4	(208)
5	(900)
6	(001)
7	(900)
8	(307)
9	(900)
10	(079)
11	(800)
12	(001)
13	(900)

↓28.6cm ↔17.1cm

Embroidery

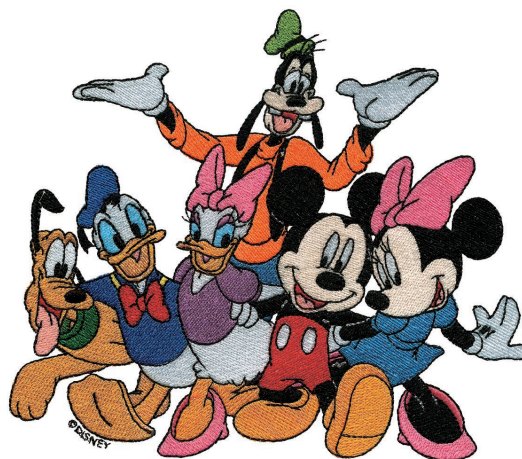

No.2 **81min**

1	(405)
2	(214)
3	(079)
4	(017)
5	(001)
6	(205)
7	(800)
8	(515)
9	(507)
10	(079)
11	(208)
12	(612)
13	(900)
14	(001)
15	(209)
16	(019)
17	(001)
18	(800)
19	(079)
20	(307)
21	(513)
22	(900)
23	(001)
24	(612)
25	(214)
26	(017)
27	(079)
28	(208)
29	(086)
30	(085)
31	(058)
32	(019)
33	(900)
34	(019)
35	(208)
36	(800)
37	(085)
38	(086)
39	(001)
40	(900)
41	(307)
42	(085)
43	(001)
44	(800)
45	(079)
46	(900)
47	(001)

↓19.7cm ↔17.2cm



No.3

17min

1	(000)
2	(747)
3	(020)
4	(100)
5	(158)
6	(122)
7	(133)
8	(000)
9	(242)
10	(025)
11	(000)
12	(745)
13	(747)
14	(100)
15	(242)

Country

↓7.6cm ↔7.7cm

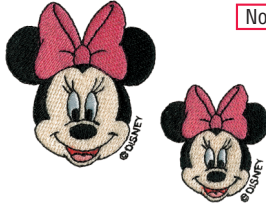

No.7

10min/6min

1	(001)
2	(307)
3	(079)
4	(800)
5	(086)
6	(900)

L: ↓6.3cm ↔5.7cm
S: ↓4.5cm ↔4.1cm



No.14

31min

1	(205)
2	(209)
3	(405)
4	(030)
5	(001)
6	(307)
7	(405)
8	(800)
9	(214)
10	(900)

↓11.5cm ↔10.6cm

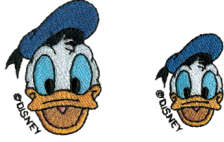

No.8

6min/4min

1	(017)
2	(001)
3	(079)
4	(214)
5	(208)
6	(405)
7	(900)

L: ↓5.1cm ↔3.6cm
S: ↓3.8cm ↔2.5cm



No.15

27min

1	(001)
2	(307)
3	(800)
4	(405)
5	(017)
6	(513)
7	(900)

↓12.1cm ↔11.0cm



No.4

19min

1	(747)
2	(745)
3	(020)
4	(122)
5	(024)
6	(133)
7	(158)
8	(122)
9	(133)
10	(000)
11	(242)
12	(025)
13	(000)
14	(745)
15	(747)
16	(100)

Country

↓9.1cm ↔7.8cm

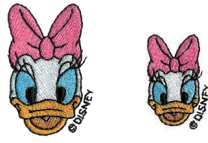

No.9

6min/4min

1	(017)
2	(001)
3	(079)
4	(214)
5	(208)
6	(085)
7	(900)

L: ↓5.0cm ↔3.2cm
S: ↓3.6cm ↔2.4cm

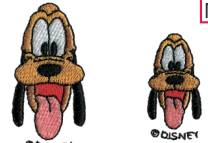

No.10

5min/3min

1	(001)
2	(800)
3	(079)
4	(214)
5	(900)

L: ↓5.6cm ↔2.7cm
S: ↓4.0cm ↔1.9cm

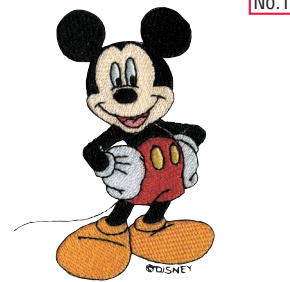

No.16

16min/11min

1	(208)
2	(205)
3	(800)
4	(001)
5	(079)
6	(307)
7	(900)
8	(001)

L: ↓10.4cm ↔7.7cm
S: ↓7.7cm ↔5.7cm



No.5

43min

1	(747)
2	(745)
3	(334)
4	(335)
5	(354)
6	(331)
7	(734)
8	(745)
9	(747)
10	(020)
11	(149)
12	(158)
13	(126)
14	(000)
15	(020)
16	(000)
17	(745)
18	(747)
19	(020)
20	(100)
21	(000)
22	(242)
23	(025)
24	(000)
25	(747)
26	(100)
27	(264)

Country

↓17.1cm ↔10.2cm

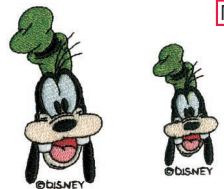

No.11

7min/4min

1	(001)
2	(307)
3	(800)
4	(079)
5	(513)
6	(900)

L: ↓6.9cm ↔3.5cm
S: ↓4.9cm ↔2.4cm

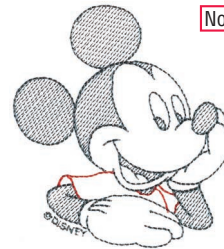

No.12

4min

1	(704)
2	(800)

↓9.2cm ↔8.2cm

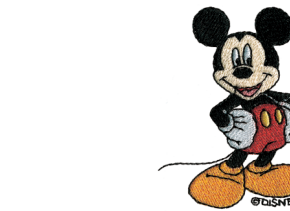

No.17

16min/10min

1	(001)
2	(307)
3	(019)
4	(085)
5	(900)
6	(001)

L: ↓10.9cm ↔5.9cm
S: ↓7.9cm ↔4.2cm

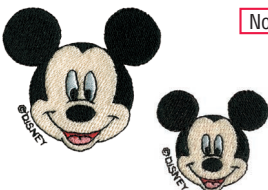

No.6

19min/55min

1	(001)
2	(307)
3	(079)
4	(800)
5	(900)

L: ↓5.5cm ↔5.9cm
S: ↓3.9cm ↔4.2cm

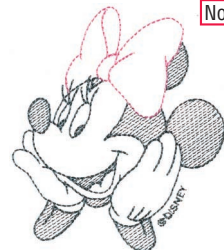

No.13

4min

1	(704)
2	(085)

↓9.1cm ↔7.9cm

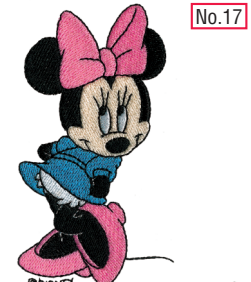



No.18

16min

- 1 (017)
 - 2 (001)
 - 3 (079)
 - 4 (214)
 - 5 (205)
 - 6 (208)
 - 7 (405)
 - 8 (800)
 - 9 (900)
- ↓9.9cm ↔7.9cm

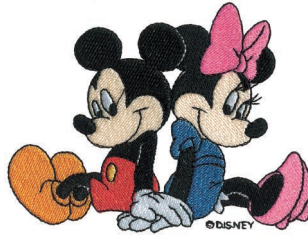

No.23

25min

- 1 (001)
 - 2 (307)
 - 3 (019)
 - 4 (085)
 - 5 (800)
 - 6 (205)
 - 7 (900)
 - 8 (800)
 - 9 (001)
- ↓8.8cm ↔11.5cm



No.29

14min

- 1 (513)
 - 2 (001)
 - 3 (800)
 - 4 (079)
 - 5 (307)
 - 6 (209)
 - 7 (405)
 - 8 (058)
 - 9 (900)
- ↓11.5cm ↔7.2cm

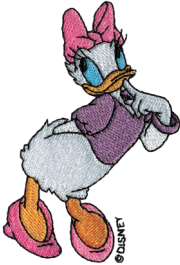

No.19

13min

- 1 (017)
 - 2 (001)
 - 3 (612)
 - 4 (208)
 - 5 (085)
 - 6 (900)
- ↓9.9cm ↔6.7cm

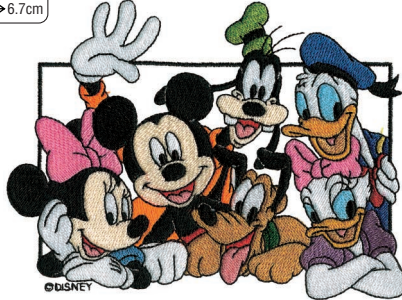

No.24

60min

- 1 (209)
 - 2 (214)
 - 3 (507)
 - 4 (001)
 - 5 (307)
 - 6 (019)
 - 7 (017)
 - 8 (405)
 - 9 (612)
 - 10 (085)
 - 11 (800)
 - 12 (079)
 - 13 (513)
 - 14 (205)
 - 15 (208)
 - 16 (900)
 - 17 (001)
- ↓11.4cm ↔15.3cm



No.30

9min

- 1 (001)
 - 2 (214)
 - 3 (507)
 - 4 (800)
 - 5 (079)
 - 6 (019)
 - 7 (900)
- ↓10.3cm ↔6.4cm



No.20

14min

- 1 (800)
 - 2 (079)
 - 3 (001)
 - 4 (507)
 - 5 (214)
 - 6 (900)
- ↓9.9cm ↔10.3cm



No.25

11min

- 1 (205)
 - 2 (208)
 - 3 (800)
 - 4 (079)
 - 5 (001)
 - 6 (307)
 - 7 (507)
 - 8 (612)
 - 9 (900)
 - 10 (001)
- ↓10.4cm ↔5.2cm



No.31

6min

- 1 (800)
 - 2 (900)
- ↓1.7cm ↔8.8cm



No.32

6min

- 1 (800)
 - 2 (900)
- ↓1.8cm ↔8.9cm



No.21

25min

- 1 (001)
 - 2 (800)
 - 3 (079)
 - 4 (307)
 - 5 (513)
 - 6 (209)
 - 7 (405)
 - 8 (058)
 - 9 (900)
- ↓14.9cm ↔10.9cm

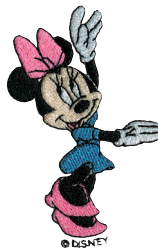

No.26

10min

- 1 (001)
 - 2 (800)
 - 3 (079)
 - 4 (307)
 - 5 (019)
 - 6 (085)
 - 7 (900)
 - 8 (001)
- ↓9.2cm ↔5.8cm

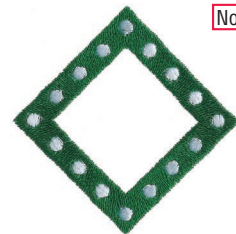

No.33

12min

- 1 (507)
 - 2 (001)
- ↓8.7cm ↔8.7cm



No.27

8min

- 1 (017)
 - 2 (001)
 - 3 (079)
 - 4 (214)
 - 5 (208)
 - 6 (085)
 - 7 (612)
 - 8 (900)
- ↓7.5cm ↔6.4cm



No.34

12min

- 1 (900)
 - 2 (001)
- ↓7.5cm ↔7.5cm

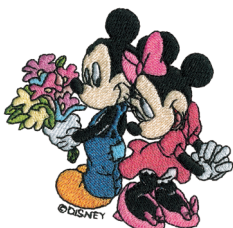

No.22

22min

- 1 (513)
 - 2 (010)
 - 3 (124)
 - 4 (810)
 - 5 (017)
 - 6 (085)
 - 7 (001)
 - 8 (307)
 - 9 (085)
 - 10 (086)
 - 11 (208)
 - 12 (019)
 - 13 (017)
 - 14 (800)
 - 15 (079)
 - 16 (900)
 - 17 (001)
- ↓8.4cm ↔8.9cm



No.28

10min

- 1 (017)
 - 2 (001)
 - 3 (205)
 - 4 (079)
 - 5 (214)
 - 6 (208)
 - 7 (405)
 - 8 (085)
 - 9 (900)
- ↓10.5cm ↔5.4cm

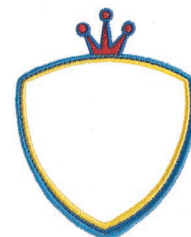

No.35

5min

- 1 (800)
 - 2 (405)
 - 3 (205)
 - 4 (019)
 - 5 (405)
- ↓8.8cm ↔6.8cm

No.36 4min

1	(015)
2	(575)

↓12.6cm ↔12.6cm

Country

No.37 4min

1	(133)
2	(155)

↓12.5cm ↔12.5cm

Country

No.38 6min

1	(001)
2	(307)
3	(800)
4	(208)
5	(900)
6	(001)
7	(513)

↓5.2cm ↔3.8cm

2.2cm

No.39 7min

1	(001)
2	(307)
3	(086)
4	(085)
5	(019)
6	(900)
7	(001)
8	(513)

↓6.4cm ↔3.9cm

2.2cm

No.40 9min

1	(001)
2	(019)
3	(007)
4	(800)

↓2.4cm ↔9.0cm

No.41 8min

1	(010)
2	(205)
3	(614)
4	(017)
5	(086)
6	(209)

↓2.5cm ↔9.0cm

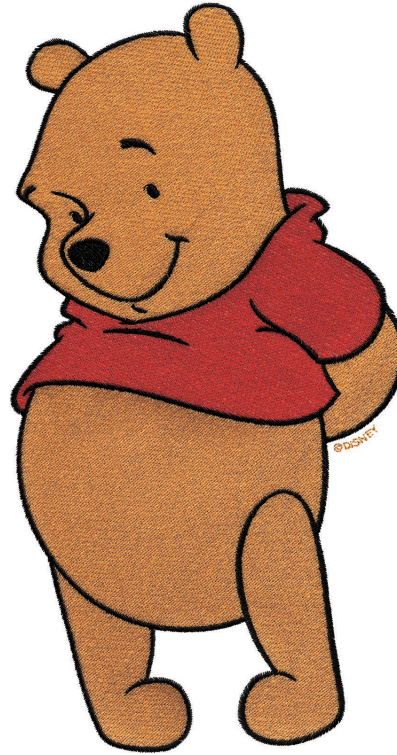

No.42 75min

1	(214)
2	(900)
3	(800)
4	(900)
5	(214)
6	(900)

↓28.6cm ↔15.1cm

No.43 71min

1	(070)
2	(209)
3	(620)
4	(307)
5	(010)
6	(612)
7	(001)
8	(900)
9	(209)
10	(010)
11	(124)
12	(900)
13	(339)
14	(070)
15	(085)
16	(107)
17	(900)
18	(214)
19	(800)
20	(070)
21	(323)
22	(339)
23	(107)
24	(079)
25	(900)
26	(612)
27	(019)
28	(086)
29	(900)
30	(086)
31	(124)
32	(085)
33	(107)
34	(339)
35	(900)

↓22.9cm ↔17.2cm

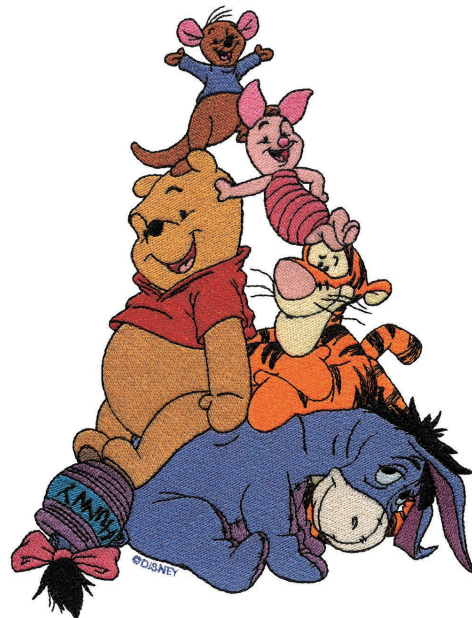



- No.44** **19min**
- 1 (335)
 - 2 (370)
 - 3 (354)
 - 4 (000)
 - 5 (100)
 - 6 (212)
 - 7 (158)
 - 8 (126)
- L: \updownarrow 7.4cm \leftrightarrow 6.6cm

Country



- No.49** **11min/6min**
- 1 (214)
 - 2 (323)
 - 3 (800)
 - 4 (900)
- L: \updownarrow 8.7cm \leftrightarrow 4.7cm
S: \updownarrow 5.3cm \leftrightarrow 2.7cm



- No.55** **9min**
- 1 (085)
 - 2 (339)
 - 3 (900)
- \updownarrow 8.1cm \leftrightarrow 6.6cm



- No.45** **3min/2min**
- 1 (214)
 - 2 (107)
 - 3 (900)
- L: \updownarrow 3.7cm \leftrightarrow 2.8cm
S: \updownarrow 2.8cm \leftrightarrow 2.0cm



- No.50** **4min/2min**
- 1 (085)
 - 2 (124)
 - 3 (086)
 - 4 (900)
- L: \updownarrow 5.8cm \leftrightarrow 2.8cm
S: \updownarrow 3.5cm \leftrightarrow 1.7cm

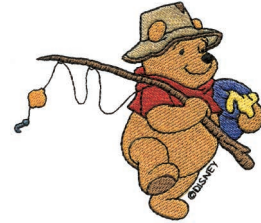

- No.56** **14min**
- 1 (843)
 - 2 (323)
 - 3 (214)
 - 4 (070)
 - 5 (205)
 - 6 (800)
 - 7 (208)
 - 8 (704)
 - 9 (900)
- \updownarrow 8.3cm \leftrightarrow 9.5cm



- No.51** **14min/7min**
- 1 (010)
 - 2 (124)
 - 3 (209)
 - 4 (900)
- L: \updownarrow 8.6cm \leftrightarrow 5.7cm
S: \updownarrow 5.1cm \leftrightarrow 3.4cm

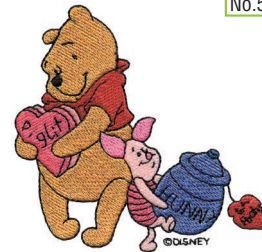

- No.57** **19min**
- 1 (085)
 - 2 (124)
 - 3 (086)
 - 4 (214)
 - 5 (070)
 - 6 (405)
 - 7 (800)
 - 8 (900)
- \updownarrow 9.4cm \leftrightarrow 9.6cm



- No.46** **3min/2min**
- 1 (085)
 - 2 (124)
 - 3 (107)
 - 4 (900)
- L: \updownarrow 3.8cm \leftrightarrow 2.7cm
S: \updownarrow 2.8cm \leftrightarrow 2.0cm



- No.52** **12min**
- 1 (019)
 - 2 (214)
 - 3 (800)
 - 4 (323)
 - 5 (900)
- \updownarrow 9.6cm \leftrightarrow 5.7cm

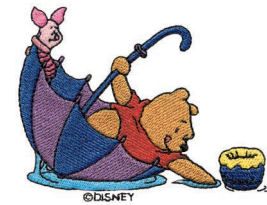

- No.58** **18min**
- 1 (017)
 - 2 (085)
 - 3 (612)
 - 4 (124)
 - 5 (086)
 - 6 (214)
 - 7 (800)
 - 8 (205)
 - 9 (405)
 - 10 (900)
- \updownarrow 7.5cm \leftrightarrow 9.6cm



- No.47** **3min/2min**
- 1 (010)
 - 2 (107)
 - 3 (209)
 - 4 (124)
 - 5 (900)
- L: \updownarrow 3.4cm \leftrightarrow 3.4cm
S: \updownarrow 2.5cm \leftrightarrow 2.5cm

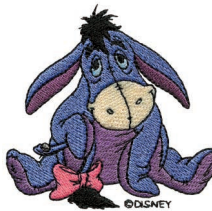

- No.53** **19min**
- 1 (001)
 - 2 (307)
 - 3 (005)
 - 4 (086)
 - 5 (620)
 - 6 (612)
 - 7 (070)
 - 8 (900)
- \updownarrow 7.8cm \leftrightarrow 7.9cm



- No.59** **27min**
- 1 (010)
 - 2 (107)
 - 3 (214)
 - 4 (209)
 - 5 (124)
 - 6 (800)
 - 7 (323)
 - 8 (900)
- \updownarrow 9.3cm \leftrightarrow 11.0cm



- No.48** **5min/4min**
- 1 (001)
 - 2 (620)
 - 3 (307)
 - 4 (070)
 - 5 (900)
- L: \updownarrow 4.4cm \leftrightarrow 4.0cm
S: \updownarrow 3.2cm \leftrightarrow 2.9cm



- No.54** **4min**
- 1 (800)
 - 2 (205)
 - 3 (507)
 - 4 (085)
 - 5 (070)
 - 6 (339)
 - 7 (900)
- \updownarrow 3.5cm \leftrightarrow 4.6cm



- No.60** **20min**
- 1 (010)
 - 2 (085)
 - 3 (124)
 - 4 (086)
 - 5 (323)
 - 6 (214)
 - 7 (800)
 - 8 (209)
 - 9 (107)
 - 10 (900)
- \updownarrow 6.6cm \leftrightarrow 9.6cm



- No.61** 21min
- 1 (214)
 - 2 (070)
 - 3 (507)
 - 4 (323)
 - 5 (058)
 - 6 (339)
 - 7 (800)
 - 8 (107)
 - 9 (405)
 - 10 (010)
 - 11 (900)
- ↓9.6cm ↔7.3cm



- No.65** 5min
- 1 (323)
- ↓9.1cm ↔5.6cm



- No.70** 19min
- 1 (010)
 - 2 (107)
 - 3 (209)
 - 4 (124)
 - 5 (800)
 - 6 (323)
 - 7 (214)
 - 8 (900)
 - 9 (507)
 - 10 (513)
- ↓7.4cm ↔9.6cm



- No.62** 46min
- 1 (001)
 - 2 (612)
 - 3 (307)
 - 4 (085)
 - 5 (124)
 - 6 (086)
 - 7 (010)
 - 8 (620)
 - 9 (070)
 - 10 (209)
 - 11 (107)
 - 12 (058)
 - 13 (513)
 - 14 (205)
 - 15 (030)
 - 16 (420)
 - 17 (339)
 - 18 (900)
- ↓11.4cm ↔16.3cm



- No.66** 3min
- 1 (323)
- ↓7.4cm ↔3.3cm



- No.71** 13min
- 1 (085)
 - 2 (085)
 - 3 (085)
 - 4 (085)
 - 5 (214)
 - 6 (800)
 - 7 (900)
- ↓9.0cm ↔9.5cm



- No.72** 1min
- 1 (513)
- ↓1.3cm ↔1.8cm



- No.67** 8min
- 1 (323)
- ↓11.1cm ↔5.1cm



- No.73** 1min
- 1 (085)
- ↓1.9cm ↔1.8cm



- No.74** 1min
- 1 (800)
- ↓1.6cm ↔1.5cm



- No.75** 1min
- 1 (085)
- ↓1.5cm ↔1.6cm



- No.76** 1min
- 1 (612)
- ↓1.7cm ↔1.7cm



- No.77** 1min
- 1 (019)
- ↓1.2cm ↔1.7cm



- No.78** 6min
- 1 (214)
 - 2 (800)
 - 3 (900)
 - 4 (086)
- ↓5.0cm ↔4.0cm

2.6cm

- No.79** 11min
- 1 (502)
 - 2 (017)
 - 3 (010)
 - 4 (001)
 - 5 (205)
 - 6 (214)
 - 7 (019)
- ↓3.2cm ↔11.0cm



© DISNEY.
Based on the "Winnie the Pooh" works
by A.A.Milne and E.H. Shepard.



No.80

- 14min
- 1 (307)
 - 2 (208)
 - 3 (205)
 - 4 (001)
 - 5 (107)
 - 6 (086)
 - 7 (019)
 - 8 (405)
 - 9 (086)
 - 10 (900)
 - 11 (001)
 - 12 (507)
 - 13 (107)
- ↓9.9cm ↔5.6cm

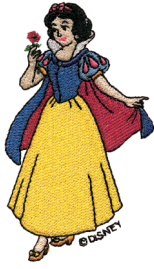

No.84

- 10min
- 1 (001)
 - 2 (307)
 - 3 (030)
 - 4 (502)
 - 5 (507)
 - 6 (612)
 - 7 (086)
 - 8 (007)
- ↓7.9cm ↔5.2cm

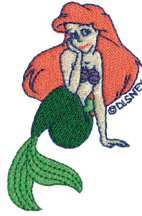

No.87

- 22min
- 1 (810)
 - 2 (001)
 - 3 (010)
 - 4 (070)
 - 5 (017)
 - 6 (019)
 - 7 (208)
 - 8 (019)
- ↓4.9cm ↔14.6cm



No.81

- 18min
- 1 (307)
 - 2 (205)
 - 3 (017)
 - 4 (001)
 - 5 (019)
 - 6 (086)
 - 7 (007)
- ↓9.9cm ↔8.1cm



No.85

- 13min
- 1 (800)
 - 2 (339)
 - 3 (107)
 - 4 (001)
 - 5 (030)
 - 6 (079)
 - 7 (007)
 - 8 (001)
 - 9 (205)
 - 10 (019)
 - 11 (405)
 - 12 (800)
 - 13 (007)
- ↓4.8cm ↔8.7cm



No.88

- 4min
- 1 (612)
 - 2 (620)
 - 3 (502)
 - 4 (534)
 - 5 (620)
 - 6 (612)
 - 7 (017)
- ↓2.2cm ↔9.4cm



No.82

- 14min
- 1 (086)
 - 2 (085)
 - 3 (001)
 - 4 (507)
 - 5 (307)
 - 6 (205)
 - 7 (214)
 - 8 (323)
 - 9 (800)
 - 10 (085)
 - 11 (058)
- ↓10.8cm ↔6.2cm

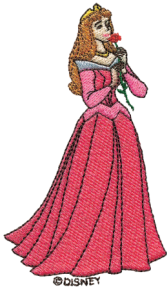

No.86

- 12min
- 1 (001)
 - 2 (307)
 - 3 (027)
 - 4 (017)
 - 5 (534)
 - 6 (502)
 - 7 (214)
 - 8 (030)
 - 9 (900)
 - 10 (001)
- ↓8.1cm ↔7.6cm



No.90

- 7min
- 1 (307)
 - 2 (010)
 - 3 (017)
 - 4 (070)
 - 5 (124)
 - 6 (085)
 - 7 (086)
 - 8 (027)
 - 9 (502)
- ↓2.6cm ↔8.1cm



No.83

- 38min
- 1 (214)
 - 2 (001)
 - 3 (307)
 - 4 (010)
 - 5 (405)
 - 6 (058)
 - 7 (323)
 - 8 (085)
 - 9 (843)
 - 10 (339)
 - 11 (205)
 - 12 (086)
 - 13 (900)
 - 14 (001)
- ↓12.2cm ↔9.4cm

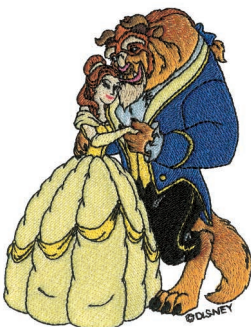

No.91

- 7min
- 1 (027)
 - 2 (502)
 - 3 (010)
 - 4 (307)
 - 5 (208)
 - 6 (017)
 - 7 (085)
 - 8 (086)
 - 9 (070)
 - 10 (086)
- ↓3.0cm ↔7.4cm



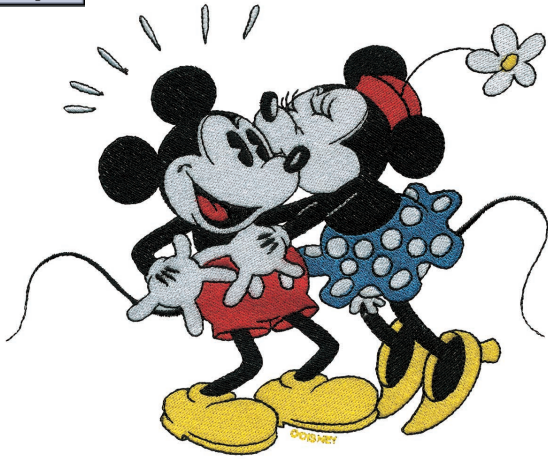

- No.92** **55min**
- 1 (205)
 - 2 (900)
 - 3 (001)
 - 4 (019)
 - 5 (900)
 - 6 (800)
 - 7 (900)
 - 8 (001)
 - 9 (205)
 - 10 (800)
 - 11 (900)
 - 12 (001)
 - 13 (800)
 - 14 (900)
 - 15 (001)
 - 16 (900)
- ↕20.4cm ↔17.0cm



- No.97** **7min**
- 1 (001)
 - 2 (214)
 - 3 (800)
 - 4 (205)
 - 5 (900)
 - 6 (001)
- ↕5.8cm ↔3.9cm



- No.98** **5min**
- 1 (001)
 - 2 (214)
 - 3 (800)
 - 4 (900)
 - 5 (001)
- ↕5.5cm ↔3.6cm

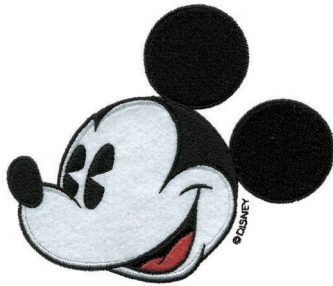

- ★ **No.93** **19min**
- 1 (001)
 - 2 (001)
 - 3 (001)
 - 4 (800)
 - 5 (900)
- ↕10.7cm ↔12.4cm

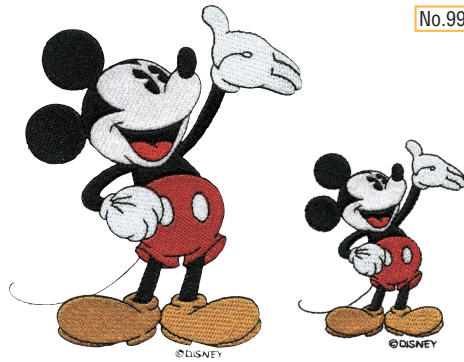

- No.99** **26min/11min**
- 1 (001)
 - 2 (800)
 - 3 (214)
 - 4 (900)
- L: ↕13.5cm ↔11.0cm
S: ↕7.9cm ↔6.3cm

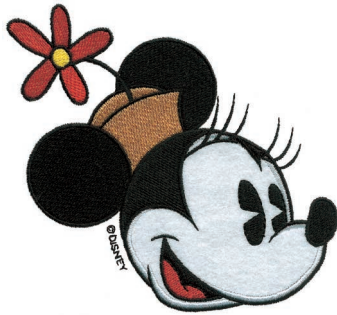

- ★ **No.94** **25min**
- 1 (001)
 - 2 (001)
 - 3 (001)
 - 4 (214)
 - 5 (800)
 - 6 (205)
 - 7 (900)
- ↕11.7cm ↔12.6cm

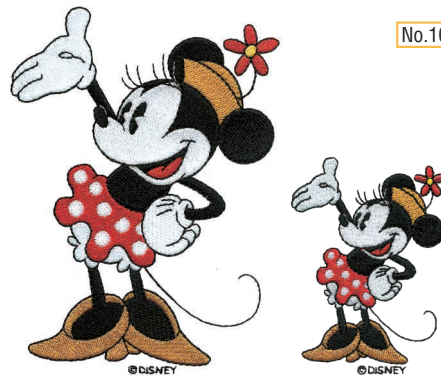

- No.100** **29min/13min**
- 1 (001)
 - 2 (800)
 - 3 (205)
 - 4 (214)
 - 5 (900)
 - 6 (001)
- L: ↕14.0cm ↔10.2cm
S: ↕8.3cm ↔5.9cm



- No.95** **4min**
- 1 (001)
 - 2 (800)
 - 3 (900)
- ↕3.9cm ↔4.0cm

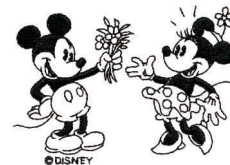

- No.101** **7min**
- 1 (900)
 - 2 (001)
- ↕6.0cm ↔8.5cm



- No.96** **5min**
- 1 (001)
 - 2 (214)
 - 3 (800)
 - 4 (205)
 - 5 (900)
- ↕4.3cm ↔4.1cm



- No.102** **6min**
- 1 (900)
- ↕6.2cm ↔8.6cm



No.103

53min

- 1 (001)
 - 2 (307)
 - 3 (612)
 - 4 (328)
 - 5 (208)
 - 6 (513)
 - 7 (339)
 - 8 (900)
 - 9 (323)
 - 10 (328)
 - 11 (001)
 - 12 (208)
 - 13 (307)
 - 14 (513)
 - 15 (612)
 - 16 (339)
 - 17 (900)
- ↓11.6cm ↔ 14.1cm



No.108

24min

- 1 (017)
 - 2 (810)
 - 3 (620)
 - 4 (001)
 - 5 (208)
 - 6 (307)
 - 7 (704)
 - 8 (800)
 - 9 (214)
 - 10 (323)
 - 11 (900)
 - 12 (001)
- ↓14.2cm ↔ 7.7cm

No.113

25min

- 1 (843)
 - 2 (010)
 - 3 (001)
 - 4 (085)
 - 5 (323)
 - 6 (339)
 - 7 (704)
 - 8 (800)
 - 9 (070)
 - 10 (086)
 - 11 (515)
 - 12 (058)
- ↓9.2cm ↔ 9.5cm



No.104

12min

- 1 (001)
 - 2 (010)
 - 3 (124)
 - 4 (614)
 - 5 (339)
 - 6 (107)
 - 7 (900)
 - 8 (323)
- ↓10.9cm ↔ 5.3cm

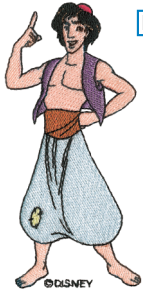

No.109

10min

- 1 (515)
 - 2 (513)
 - 3 (058)
 - 4 (214)
 - 5 (001)
 - 6 (307)
 - 7 (030)
 - 8 (339)
 - 9 (507)
 - 10 (900)
- ↓10.3cm ↔ 4.4cm



No.114

19min

- 1 (001)
 - 2 (843)
 - 3 (079)
 - 4 (704)
 - 5 (307)
 - 6 (214)
 - 7 (339)
 - 8 (019)
 - 9 (328)
 - 10 (058)
- ↓9.6cm ↔ 6.9cm



No.110

18min

- 1 (001)
 - 2 (079)
 - 3 (010)
 - 4 (323)
 - 5 (339)
 - 6 (214)
 - 7 (058)
 - 8 (900)
 - 9 (001)
 - 10 (124)
 - 11 (843)
 - 12 (704)
 - 13 (339)
 - 14 (513)
 - 15 (010)
 - 16 (208)
 - 17 (086)
 - 18 (900)
- ↓7.8cm ↔ 9.9cm



No.115

24min

- 1 (001)
 - 2 (339)
 - 3 (843)
 - 4 (307)
 - 5 (030)
 - 6 (323)
 - 7 (900)
- ↓10.0cm ↔ 8.7cm



No.105

29min

- 1 (019)
 - 2 (001)
 - 3 (214)
 - 4 (800)
 - 5 (070)
 - 6 (019)
 - 7 (900)
- ↓14.3cm ↔ 11.6cm

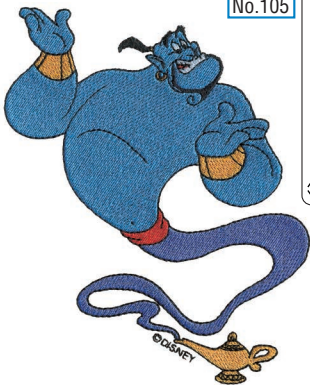

No.111

14min

- 1 (843)
 - 2 (001)
 - 3 (323)
 - 4 (405)
 - 5 (010)
 - 6 (513)
 - 7 (208)
 - 8 (086)
 - 9 (900)
 - 10 (001)
- ↓6.3cm ↔ 5.8cm



No.116

19min

- 1 (005)
 - 2 (001)
 - 3 (019)
 - 4 (205)
 - 5 (079)
 - 6 (017)
 - 7 (800)
 - 8 (124)
 - 9 (900)
- ↓7.2cm ↔ 9.7cm

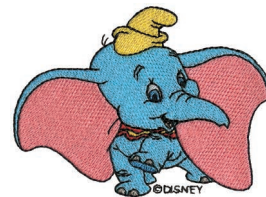

No.106

15min

- 1 (001)
 - 2 (307)
 - 3 (019)
 - 4 (085)
 - 5 (205)
 - 6 (086)
 - 7 (058)
 - 8 (900)
- ↓8.1cm ↔ 8.6cm



No.112

32min

- 1 (124)
 - 2 (001)
 - 3 (800)
 - 4 (019)
 - 5 (208)
 - 6 (900)
- ↓12.5cm ↔ 10.4cm



No.117

46min

- 1 (058)
 - 2 (010)
 - 3 (323)
 - 4 (339)
 - 5 (214)
 - 6 (079)
 - 7 (086)
 - 8 (001)
 - 9 (900)
- ↓11.7cm ↔ 11.7cm

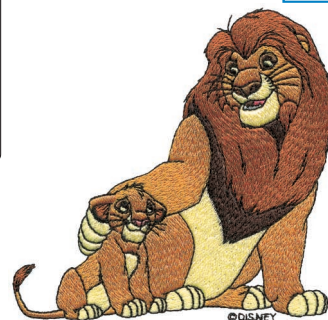

No.107

8min

- 1 (017)
 - 2 (019)
 - 3 (307)
 - 4 (001)
 - 5 (502)
 - 6 (205)
 - 7 (086)
 - 8 (900)
- ↓8.5cm ↔ 5.4cm



Examples of Combinations
Kombinationsbeispiele
Ejemplos de combinaciones

Exemples de combinaisons
Voorbeelden van combinaties
Esempi di combinazioni

Using the various patterns in combination will expand your world of enjoyment.

En utilisant les différents motifs en combinaisons, vous aurez encore plus de plaisir à coudre.

Durch die Verwendung der verschiedenen Muster und deren Kombinationen werden die Anwendungsmöglichkeiten stark erweitert.

Het in combinatie gebruiken van de verschillende patronen bidet vele leuke nieuwe mogelijkheden.

Usando diferentes patrones combinados podrá expandir el mundo de diversión.

L'uso dei vari disegni in combinazione fra loro espande esponenzialmente le possibilità di divertirsi cucendo.

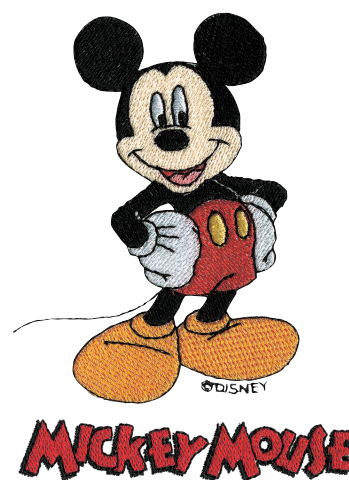
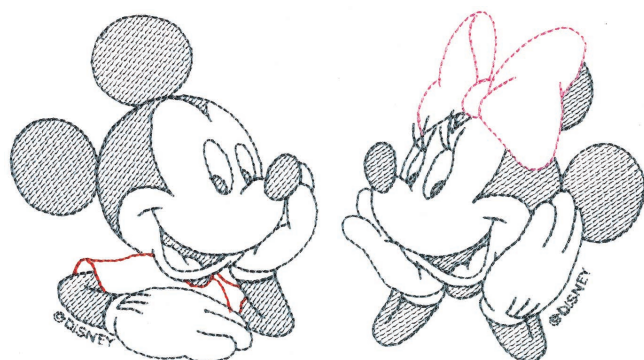
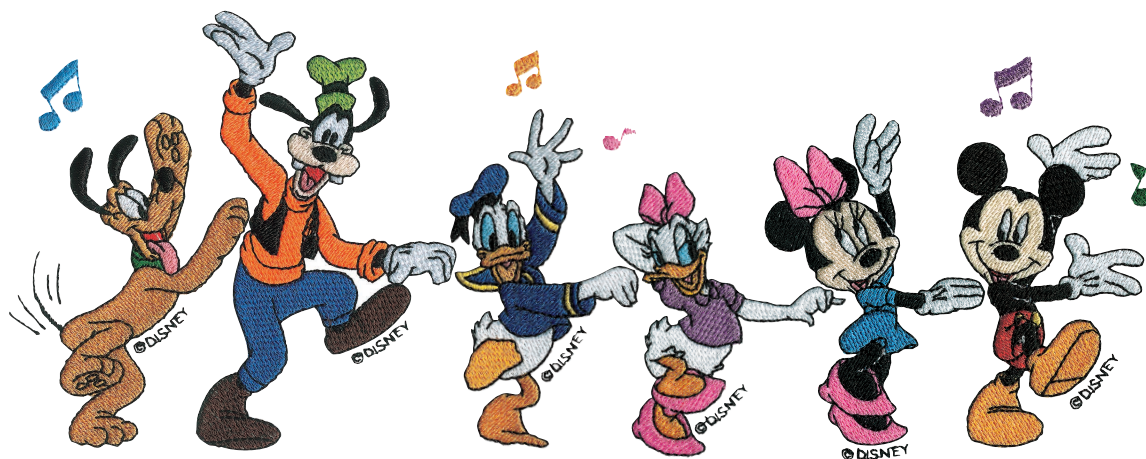

English
German
French
Dutch
Italian
Spanish

882-S85/S90/S94
Printed in Taiwan



XC8171-251②