

brother[®]

Version 4.0
Installation Guide

ENGLISH

Version 4.0
Installationsanleitung

DEUTSCH

Guide d'installation
version 4.0

FRANÇAIS

Versie 4.0
Installatiegids

NEDERLANDS

Guida all'installazione
della versione 4.0

ITALIANO

Guía de instalación
versión 4.0

ESPAÑOL

Innov-is

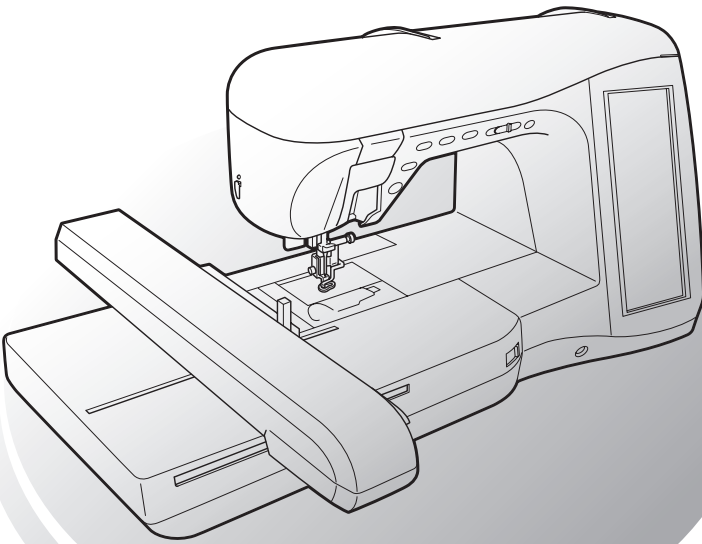

- Read this guide before installing.
- Lesen Sie diese Anleitung vor der Installation durch.
- Lisez ce guide avant de procéder à l'installation.
- Lees deze gids alvorens te installeren.
- Leggere il presente guida prima dell'installazione.
- Antes de instalar, lea este guía.

Thank you for choosing our product.

For additional product information and updates, visit our web site at www.brother.com.
The contents of this guide and specifications of this product are subject to change without notice.

This upgrade is for sewing machines installed with version 3.0 or later.
Before upgrading to version 4.0, check the version of your sewing machine.

Vielen Dank, dass Sie sich für unser Produkt entscheiden haben.

Zusätzliche Produktinformationen und Aktualisierungen finden Sie auf unserer Website unter www.brother.com.

Änderungen am Inhalt dieser Anleitung und den Produktspezifikationen vorbehalten.

Diese Aktualisierung ist für Nähmaschinen geeignet, die mit Version 3.0 oder später ausgestattet sind.
Überprüfen Sie die Version Ihrer Nähmaschine bevor Sie auf Version 4.0 aktualisieren.

Nous vous remercions d'avoir choisi notre produit.

Pour plus d'informations sur le produit et les mises à jour, visitez notre site Web à l'adresse www.brother.com.

Le contenu de ce guide et les spécifications de ce produit peuvent être modifiés sans avis préalable.

Cette mise à niveau concerne les machines à coudre sur lesquelles la version 3.0 ou une version ultérieure est installée.
Avant de mettre à niveau à la version 4.0, vérifiez la version installée sur votre machine à coudre.

Gefeliciteerd met de aanschaf van dit product.

Meer informatie over onze producten en updates vindt u op onze website www.brother.com.
De inhoud van deze gids en de specificaties van dit product kunnen zonder kennisgeving worden gewijzigd.

Deze upgrade is voor naaimachines die met versie 3.0 of recenter zijn geïnstalleerd.
Controleer de versie van uw naaimachine voordat u de upgrade tot versie 4.0 uitvoert.

Grazie per aver acquistato il nostro prodotto.

Per ulteriori informazioni sui prodotti e per gli aggiornamenti, visitare il nostro sito Web all'indirizzo www.brother.com.

Il contenuto del guida e le specifiche del prodotto sono soggetti a modifiche senza preavviso.

Questo aggiornamento è per macchine da cucire con versione 3.0 o successiva.
Prima di effettuare l'aggiornamento alla versione 4.0, controllare la versione della propria macchina da cucire.

Le agradecemos que haya elegido nuestro producto.

Para obtener información adicional del producto y actualizaciones, visite nuestro sitio Web en www.brother.com.

El contenido de este guía y las especificaciones de este producto pueden sufrir cambios sin previo aviso.

Esta actualización es para máquinas de coser con la versión 3.0 o superior instalada.
Antes de actualizar a la versión 4.0, compruebe la versión de su máquina de coser.

CONTENTS

Accessories	2
Contents of CD-ROM	2
Installation Overview	2
Verifying the Operating Environment	3
Installation Procedure.....	3

Accessories

Check that the following items are provided. If anything is missing or damaged, contact your authorized dealer or Brother Customer Service.

- CD-ROM (For details on the contents, refer to the following.)



- Installation Guide (this guide)

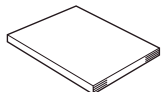

In addition, this kit contains the border embroidery frame and embroidery sheet for easy reference when hooping the fabric.

- Border embroidery frame
Since the sewing area can easily be changed when the border embroidery frame is used, repeated patterns can be sewn simply by sliding the fabric. An area of 10 cm × 18 cm (approx. 4 inches × 7 inches) can be embroidered.

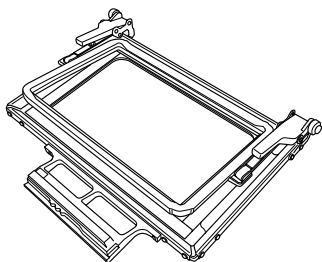

- Embroidery sheet
This embroidery sheet is for the border embroidery frame. It is used to position the fabric after the embroidering location is determined.

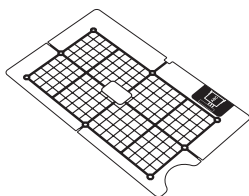

- Embroidery Pattern Color Change Table
This is the color change table for the embroidery patterns on the CD-ROM. Most of the patterns on the CD-ROM are either single patterns or repeated patterns.





Contents of CD-ROM

- Certification Key Issuing Wizard
- Version 4.0 Upgrade Kit Operation Manual (PDF)
 - * Adobe® Reader® or Adobe® Acrobat® Reader® is required for viewing and printing the Operation Manual.
- Upgrade application for version 4.0
- Update application for version 2.03 or later
 - * For the newest version of 2.03 or later, visit www.brother.com.
- Update application for version 3.10 or later
 - * For the newest version of 3.10 or later, visit www.brother.com.
- Embroidery patterns for border embroidery frame

Installation Overview

First, use the Certification Key Issuing Wizard on the enclosed CD-ROM to obtain a certification key. Then, use the certification key to install the upgrade application for version 4.0 on the sewing machine.

In the procedure area,  indicates operations performed with the sewing machine and  indicates operations performed with the computer.



[Step 1] Make a note of the machine number (NO.).



[Step 2] Insert the CD-ROM into the computer's CD-ROM drive, and then start the Certification Key Issuing Wizard.



[Step 3] Follow the wizard directions to obtain the certification key.



[Step 4] Install the upgrade application for version 4.0 on the sewing machine.



[Step 5] Restart the sewing machine, and then enter the certification key.



[Step 6] When the upgrade is finished, the sewing machine automatically restarts.

Verifying the Operating Environment

Before starting the Certification Key Issuing Wizard, check that the computer to be connected meets the following operating conditions.

Computer	IBM-PC or compatible computer
Operating System	Windows® 98SE* ¹ , Me, 2000, XP or Vista
CD-ROM drive	Required for installation
Others	Internet connection available and one available USB port (required to upgrade the sewing machine)

* IBM is a registered trademark of IBM Corporation in the United States and other countries.

* Windows is a registered trademark of Microsoft Corporation in the United States and other countries.

*¹ Windows 98SE requires a driver. Download the driver from our web site (www.brother.com). In addition, only Windows 98 Second Edition can use the driver.

Installation Procedure

The following procedure describes how to upgrade your sewing machine to version 4.0.



Note

- If the procedure described below is not fully completed, your sewing machine cannot be upgraded to version 4.0.
- Access to the Internet is required in order to obtain a certification key.



1

Make a note of the 10-digit number (machine number) displayed beside “NO.” on P.3 of the settings screen.



Note

- Confirm the version is 3.0 or later. If the version is not 3.0 or later, contact your authorized dealer or Brother Customer Service for version 3.0.



Memo

- Since this number will be entered when a certification key is obtained, be sure to write it down correctly.



Machine number (NO.)

Version number



Note

- The number that appears beside “NO.” is different from the serial number (SER. NO.) on the label attached to the back of the sewing machine.



- 2 Insert the CD-ROM into the computer's CD-ROM drive.



Memo

In Windows Vista, when the **AutoPlay** dialog box appears, click **Open folder to view files**.



- 3 Open drive D (when drive D is the CD-ROM drive) of **My Computer**, double-click , and then start the **Certification Key Issuing Wizard**.



Memo

The following procedure can be used to start the Certification Key Issuing Wizard.

1. Click **Start**.
2. Click **Run**.

→ The **Run** dialog box appears.

3. Type in the path (D:\KeyWizard4.exe) to the application file, and then click **OK**.

→ The **Select Language** dialog box automatically appears.



- 4 Select the desired language, and then click **OK**.



→ **Version 4.0 Certification Key Issuing Wizard** appears.



- 5 Read the information that appears, and then click **Next**.



- 6 Type in the 15-digit CD key found on the label attached to the CD case of the upgrade kit, and then click **Next**.



If the following message appears

Check for the following. To close the message, click **OK**.

- Are symbols or characters other than letters and numbers entered?
- Has the number "1" or the uppercase letter "l" been incorrectly entered?
- Has the number "0" or the uppercase letter "O" been incorrectly entered?





7 Type in the machine number (NO.) written down in step **1**, and then click **Next**.

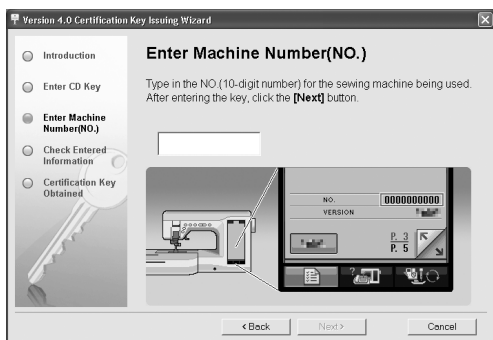

If the following message appears

Check that symbols or characters other than numbers have not been entered. To close the message, click **OK**.



8 Check the entered information, and then click **Certify** if it has been entered correctly. To change the entered information, click **Back**.



Note

- In order to obtain a certification key, a connection to the Internet must be established.

→ Connect to the certification server, and then obtain the upgrade certification key.

If the following message appears

Important:

- The CD key is valid for only one sewing machine. Check that the CD key has been entered correctly, and then repeat the procedure from step **3**. To close the message, click **OK**.

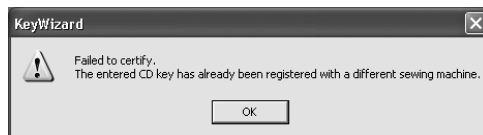

- Check that the CD key and machine number (NO.) have been entered correctly, and then repeat the procedure from step **3**. To close the message, click **OK**.



- Check the Internet connection, and then click **Certify** again. To close the message, click **OK**.

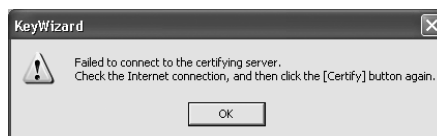

9 Write down the 8-digit certification key that appears.



Note

- After upgrading the sewing machine to version 4.0, the certification key must be entered in the sewing machine screen.



10 Click **Finish**.



11 While pressing the "Automatic Threading" button, turn the sewing machine on.

Use USB media or a computer to install the upgrade application for version 4.0 on the sewing machine.

If **USB media** is to be used, refer to the instructions that follow.

If a **computer** is to be used, refer to page 7.

When using USB media to perform the installation



12 Copy **Upgrade application for version 4.0** from the CD-ROM to the USB media.



Note

- Do not copy any file other than **Upgrade application for version 4.0** to the USB media.



13 Press  .

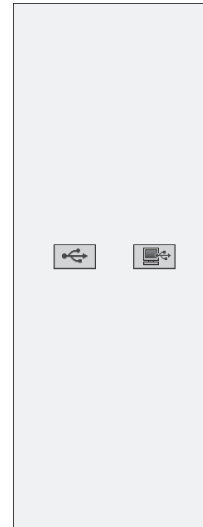

14 Insert the USB media into the USB port connector on the machine.

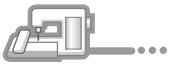

15 Press **LOAD**.

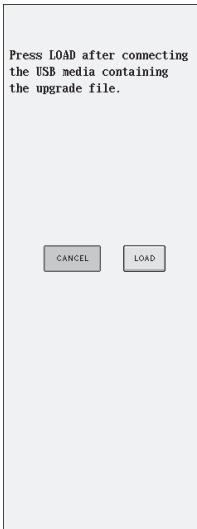

Note

When the message **“Upgrade complete”** appears, installation of the upgrade application is completed. (If an error occurred, a message appears in red.)



16 Remove the USB media.

Continue with step 17 on page 8.

When using a computer to perform the installation



12 Press .

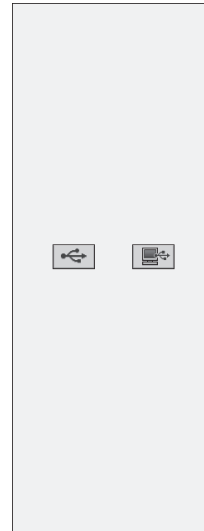

13 Plug the USB cable connectors into the corresponding USB port connectors for the computer and for the machine.

→ **Removable Disk** appears in **My Computer**.



- 14** Copy **Upgrade application for version 4.0** from the CD-ROM to **Removable Disk**.

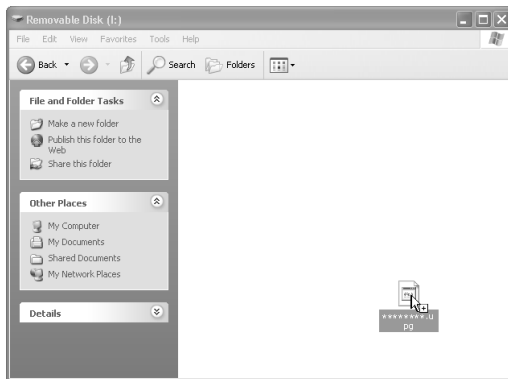

Note

The **“Connected to PC. Do not disconnect the USB cable”**. message appears on the sewing machine LCD screen.



- 15** Press **LOAD**.

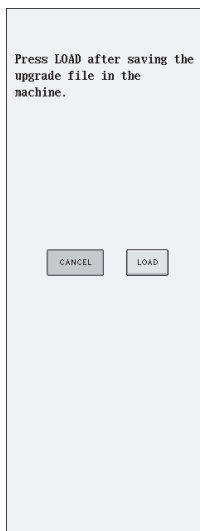

Note

When the message **“Upgrade complete”**. appears, installation of the upgrade application is completed. (If an error occurred, a message appears in red.)



- 16** Unplug the USB cable.



- 17** Turn the sewing machine off, then on again.
→ The following screen appears on the LCD.



- 18** Type in the 8-digit certification key written down in step **9**, and then press **SET**.



→ When the version 4.0 certification number is set, the sewing machine automatically restarts.



Note

- If the message **The certification key is incorrect**. appeared, write down the 10-digit number that appears beside “NO.” at the top of the screen, and then repeat steps **2** through **10** to obtain the certification key.
- If the certification key is lost, repeat steps **2** through **10** to obtain the certification key.
- When trying to upgrade a version 2.0 machine to version 4.0, the message “This upgrade is not applicable. Please upgrade the machine to version 3.0 first.” appears. Use the file on the CD-ROM to return the machine to version 2.0.
- This upgrade kit (version 4.0) is for machine installed with version 3.0 or later. A machine installed with version 2.0 cannot be upgraded to version 4.0 with this upgrade kit. Please contact your authorized dealer or Brother Customer Service for version 3.0.

INHALT

Zubehör	10
Inhalt der CD-ROM.....	10
Installationsübersicht.....	10
Überprüfen der Betriebsumgebung.....	11
Installation	11

Zubehör

Überprüfen Sie, ob folgende Bauteile vorhanden sind. Sollte etwas fehlen oder beschädigt sein, wenden Sie sich bitte an Ihren Brother-Fachhändler oder den Brother-Kundenservice.

- CD-ROM (Einzelheiten zu den Inhalten finden Sie im Folgenden.)



- Installationsanleitung (diese Anleitung)

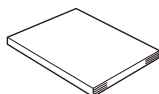

Dieses Upgrade-Kit enthält außerdem einen Bordüren-Stickrahmen mit Stickschablone zum einfachen Einspannen von Stoffen.

- Bordüren-Stickrahmen
Da es mit dem Randmuster-Stickrahmen leicht ist, den Stickbereich zu ändern, können wiederholte Stickmuster einfach durch Verschieben des Stoffes gestickt werden. Der Stickbereich ist 10 x 18 cm groß (ca. 4 x 7 Zoll).

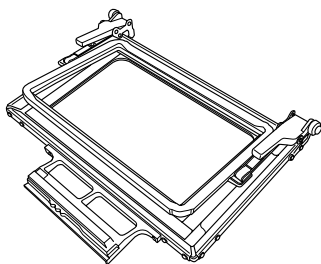

- Stickschablone
Diese Stickschablone ist für den Bordüren-Stickrahmen. Sie wird verwendet, um den Stoff nach Festlegung des Stickbereichs zu positionieren.

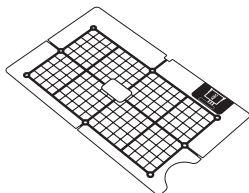

- Stickmuster-Farbtabelle
Dies ist die Farbtabelle für die Stickmuster auf der CD-ROM. Die meisten Stickmuster auf der CD-ROM sind entweder Einfach- oder Mehrfachmuster.





Inhalt der CD-ROM

- Assistent zur Erzeugung eines Bestätigungsschlüssels
- Bedienungsanleitung (PDF) für das Upgrade-Kit Version 4.0
 - * Um diese Bedienungsanleitung anzusehen und auszudrucken, benötigen Sie Adobe® Reader® oder Adobe® Acrobat® Reader®.
- Upgrade-Anwendung für Version 4.0
- Aktualisierungsanwendung für Version 2.03 oder später
 - * Die neueste Version von 2.03 oder später finden Sie auf www.brother.com.
- Aktualisierungsanwendung für Version 3.10 oder später
 - * Die neueste Version von 3.10 oder später finden Sie auf www.brother.com.
- Stickmuster für den Bordüren-Stickrahmen

Installationsübersicht

Zuerst müssen Sie den Assistenten zur Erzeugung eines Bestätigungsschlüssels auf der mitgelieferten CD-ROM benutzen, um den Bestätigungsschlüssel zu erhalten. Benutzen Sie danach diesen Bestätigungsschlüssel zur Installation der Upgrade-Anwendung für die Version 4.0 auf Ihrer Nähmaschine.

Bei diesen Vorgängen weist  auf Handlungen an der Nähmaschine und  auf Handlungen am Computer hin.



[Schritt 1] Notieren Sie die Maschinenummer (NO.).



[Schritt 2] Legen Sie die CD-ROM in das CD-ROM-Laufwerk des Computers ein und starten Sie den Assistenten zur Erzeugung eines Bestätigungsschlüssels.



[Schritt 3] Befolgen Sie die Anweisungen des Assistenten, um den Bestätigungsschlüssel zu erhalten.



[Schritt 4] Installieren Sie die Upgrade-Anwendung für die Version 4.0 auf Ihrer Nähmaschine.



[Schritt 5] Starten Sie die Nähmaschine neu und geben Sie den Bestätigungsschlüssel ein.



[Schritt 6] Wenn das Upgrade beendet ist, startet die Nähmaschine automatisch neu.

Überprüfen der Betriebsumgebung

Bevor Sie den Assistenten zur Erzeugung eines Bestätigungsschlüssels starten, vergewissern Sie sich, dass der anzuschließende Computer die folgenden Systemvoraussetzungen erfüllt.

Computer	IBM-PC oder ein kompatibler Computer
Betriebssystem	Windows® 98SE* ¹ , Me, 2000, XP oder Vista
CD-ROM-Laufwerk	Für die Installation erforderlich
Sonstige	Internetverbindung und ein freier USB-Anschluss (erforderlich für das Upgrade der Nähmaschine)

- * IBM ist ein eingetragenes Warenzeichen der IBM Corporation in den USA und anderen Ländern.
- * Windows ist ein eingetragenes Warenzeichen der Microsoft Corporation in den USA und anderen Ländern.
- *¹ Für Windows 98SE ist ein Treiber erforderlich. Sie können den Treiber von unserer Website (www.brother.com) herunterladen. Dieser Treiber eignet sich ausschließlich für Windows 98 Second Edition.

Installation

Im Folgenden wird die Vorgehensweise für das Upgrade Ihrer Nähmaschine auf Version 4.0 beschrieben.



Hinweis

- Wird die im Folgenden beschriebene Vorgehensweise nicht vollständig durchgeführt, kann das Upgrade Ihrer Nähmaschine auf Version 4.0 nicht erfolgen.
- Ein Internetzugang ist erforderlich, damit Sie den Bestätigungsschlüssel erhalten.



1

Notieren Sie sich die 10-stellige Nummer (Maschinennummer), die neben „NO.“ auf P.3 des Einstellungsbildschirms angezeigt wird.



Hinweis

Achten Sie darauf, dass es die Version 3.0 oder höher ist. Ist dies nicht der Fall, wenden Sie sich an Ihren Brother-Fachhändler oder den Brother-Kundendienst, um die Version 3.0 zu beziehen.



Anmerkung

- Da diese Nummer eingegeben wird, wenn Sie den Bestätigungsschlüssel erhalten, vergewissern Sie sich, dass Sie die Nummer korrekt notiert haben.



Maschinennummer (NO.)

Versionsnummer



Hinweis

- Die Nummer neben „NO.“ unterscheidet sich von der Seriennummer (SER. NO.) auf dem Etikett auf der Rückseite der Nähmaschine.



- 2 Legen Sie die CD-ROM in das CD-ROM-Laufwerk des Computers ein.



Anmerkung

Wenn in Windows Vista das Dialogfeld **Automatische Wiedergabe** erscheint, klicken Sie auf **Ordner öffnen, um Dateien anzuzeigen**.



- 3 Öffnen Sie Laufwerk D (wenn Laufwerk D das CD-ROM-Laufwerk ist) unter **Arbeitsplatz**, doppelklicken Sie auf  und starten Sie dann den **Assistenten zur Erzeugung eines Bestätigungsschlüssels**.



Anmerkung

- Die folgende Vorgehensweise kann zum Starten des Assistenten zur Erzeugung eines Bestätigungsschlüssels benutzt werden.
 - Klicken Sie auf **Start**.
 - Klicken Sie auf **Ausführen**.

→ Das Dialogfenster **Ausführen** erscheint.

- Geben Sie den Pfad (D:\KeyWizard4.exe) der Anwendungsdatei ein und klicken Sie auf **OK**.

→ Das Dialogfenster **Select language (Sprache auswählen)** erscheint automatisch.



- 4 Wählen Sie die gewünschte Sprache aus und klicken Sie **OK**.



→ **Assistent zur Erzeugung eines Bestätigungsschlüssels für Version 4.0** erscheint.



- 5 Lesen Sie die angezeigten Informationen und klicken Sie dann **Weiter**.

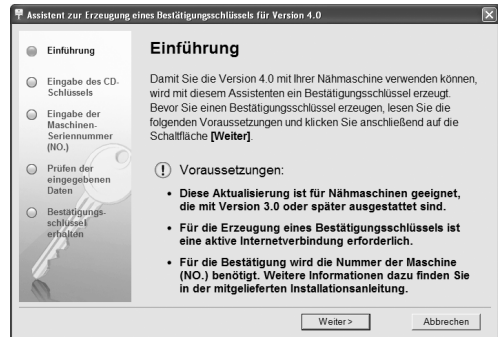

- 6 Geben Sie den auf dem Etikett der CD-Hülle des Upgrade-Kits gedruckten 15-stelligen CD-Schlüssel ein und klicken Sie auf **Weiter**.

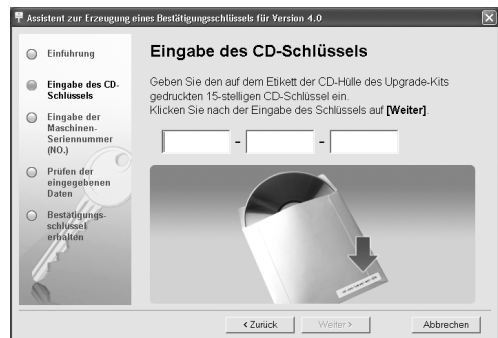

Wenn die folgende Meldung erscheint

Überprüfen Sie Folgendes. Zum Schließen der Meldung, klicken Sie **OK**.

- Wurden Symbole oder Zeichen eingegeben, die nicht Buchstaben und Nummern sind?
- Wurden die Nummer „1“ und der Großbuchstabe „I“ richtig eingegeben?
- Wurden die Nummer „0“ und der Großbuchstabe „O“ richtig eingegeben?





- 7 Geben Sie die Maschinenummer (NO.) ein, die Sie in Schritt 1 notiert haben und klicken Sie auf **Weiter**.

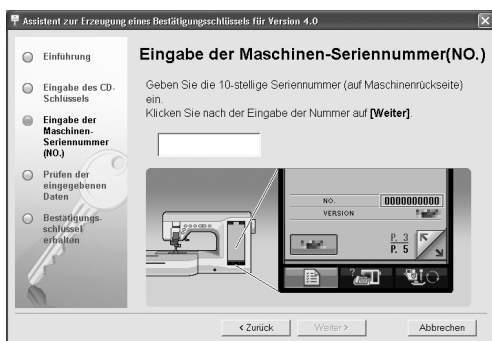

Wenn die folgende Meldung erscheint
Vergewissern Sie sich, dass nur Nummern und Buchstaben eingegeben wurden. Zum Schließen der Meldung, klicken Sie **OK**.



- 8 Überprüfen Sie die eingegebenen Informationen und klicken Sie auf **Bestätigen**, wenn alles korrekt eingegeben wurde. Um die eingegebenen Informationen zu ändern, klicken Sie auf **Zurück**.

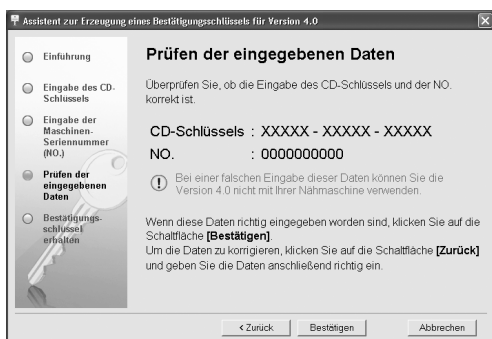

Hinweis
• Für die Erzeugung eines Bestätigungsschlüssels ist eine aktive Internetverbindung erforderlich.

→ Stellen Sie eine Verbindung mit dem Bestätigungs-Server her, um den Bestätigungsschlüssel für das Upgrade zu erhalten.

Wenn die folgende Meldung erscheint

Wichtig:

- Der CD-Schlüssel ist nur für eine Nähmaschine gültig. Vergewissern Sie sich, dass der CD-Schlüssel richtig eingegeben wurde und wiederholen Sie den Vorgang von Schritt 3. Zum Schließen der Meldung, klicken Sie **OK**.

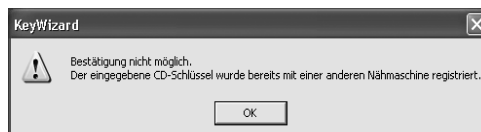

- Überprüfen Sie, ob der CD-Schlüssel und die Maschinenummer (NO.) richtig eingegeben wurden und wiederholen Sie den Vorgang von Schritt 3. Zum Schließen der Meldung, klicken Sie **OK**.



- Überprüfen Sie die Internetverbindung und klicken Sie anschließend erneut auf **Bestätigen**. Zum Schließen der Meldung, klicken Sie **OK**.



- 9 Notieren Sie sich den nun erscheinenden 8-stelligen Bestätigungsschlüssel.

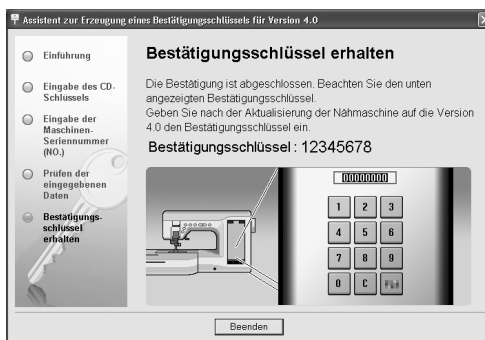

Hinweis
• Nach dem Upgrade der Nähmaschine auf Version 4.0 muss der Bestätigungsschlüssel am Nähbildschirm eingegeben werden.



- 10 Klicken Sie **Beenden**.



- 11 Halten Sie die Taste „Automatisches Einfädeln“ gedrückt und schalten Sie die Nähmaschine ein.

Benutzen Sie danach ein USB-Medium oder einen Computer zur Installation der Upgrade-Anwendung für die Version 4.0 auf Ihrer Nähmaschine.

Wenn ein **USB-Medium** benutzt wird, folgen Sie den nachstehenden Anweisungen.

Wenn ein **Computer** benutzt wird, siehe Seite 15.

Wenn ein USB-Medium für die Installation benutzt

wird 



- 12 Kopieren Sie **die Upgrade-Anwendung für Version 4.0** von der CD-ROM auf das USB-Medium.



Hinweis

- Kopieren Sie außer der **Upgrade-Anwendung für Version 4.0** keine anderen Dateien auf das USB-Medium.



- 13 Drücken Sie  .

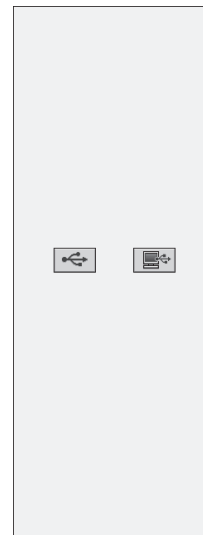

- 14 Stecken Sie das USB-Medium in die USB-Medienanschlussbuchse der Maschine ein.



15 Drücken Sie **LADEN** .



Hinweis

Wenn die Meldung „**Aktualisierung abgeschlossen**“ erscheint, ist die Installation des Upgrades fertiggestellt.
(Wenn ein Fehler aufgetreten ist, wird eine Fehlermeldung in rot angezeigt.)



16 Entfernen Sie das USB-Medium.

Fahren Sie mit Schritt 17 auf Seite 16 fort.

Wenn eine Computer zur Installation benutzt wird



12 Drücken Sie  .

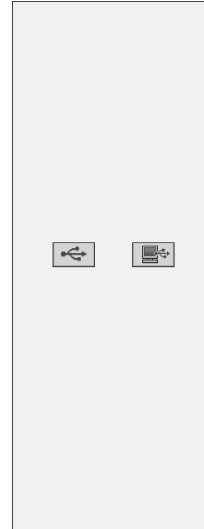

13 Stecken Sie das USB-Kabel in die entsprechenden USB-Anschlussbuchsen am Computer und an der Maschine ein.

→ **Wechseldatenträger** erscheint in **Arbeitsplatz**.



- 14** Kopieren Sie die **Upgrade-Anwendung für Version 4.0** von der CD-ROM auf **Wechseldatenträger**.

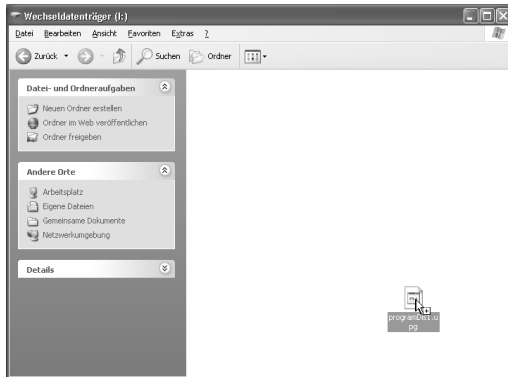

Hinweis

Die Meldung „**Aktive PC-Verbindung. Das USB-Kabel nicht trennen.**“ erscheint auf dem LCD-Bildschirm der Nähmaschine.



- 15** Drücken Sie **LADEN**.



Hinweis

Wenn die Meldung „**Aktualisierung abgeschlossen**“ erscheint, ist die Installation des Upgrades fertiggestellt. (Wenn ein Fehler aufgetreten ist, wird eine Fehlermeldung in rot angezeigt.)



- 16** Ziehen Sie das USB-Kabel aus der USB-Anschlussbuchse.



- 17** Schalten Sie die Maschine aus und wieder ein.
→ Der folgende Bildschirm wird angezeigt.



- 18** Geben Sie den 8-stelligen **Bestätigungsschlüssel** ein, den Sie in **Schritt 9** notiert haben, und drücken Sie dann **EINSTELLEN**.



→ Wenn die Bestätigungsnummer für Version 4.0 eingestellt ist, startet die Nähmaschine automatisch neu.



Hinweis

- Wenn die Meldung **Der Bestätigungsschlüssel ist falsch** erscheint, notieren Sie sich die 10-stellige Nummer neben „NO.“ in der oberen Bildschirmhälfte und wiederholen Sie die Schritte **2** bis **10**, um den Bestätigungsschlüssel zu erhalten.
- Wenn der Bestätigungsschlüssel verloren geht, wiederholen Sie die Schritte **2** bis **10**, um den Bestätigungsschlüssel zu erhalten.
- Wenn Sie versuchen, eine Maschine mit der Version 2.0 auf die Version 4.0 zu aktualisieren, wird die Meldung „Diese Aktualisierung ist nicht anwendbar. Aktualisieren Sie das Gerät zuerst auf Version 3.0.“ angezeigt. Verwenden Sie die Datei auf der CD-ROM, um die Version 2.0 in der Maschine wiederherzustellen.
- Dieses Upgrade-Kit (Version 4.0) ist für Maschinen, auf denen die Version 3.0 oder höher installiert ist. Mit diesem Upgrade-Kit können Maschinen, auf denen die Version 2.0 läuft, nicht auf die Version 4.0 aktualisiert werden. Bitte wenden Sie sich an Ihren Brother-Fachhändler oder den Brother-Kundendienst, um die Version 3.0 zu beziehen.

TABLE DES MATIÈRES

Accessoires	18
Contenu du CD-ROM	18
Vue d'ensemble de l'installation.....	18
Vérification de l'environnement d'utilisation	19
Procédure d'installation.....	19

Accessoires

Vérifiez que les éléments suivants sont fournis. Si un élément est manquant ou endommagé, contactez votre revendeur agréé ou le service client Brother.

- CD-ROM (pour plus d'informations sur le contenu, reportez-vous aux indications suivantes)



- Guide d'installation (ce guide)

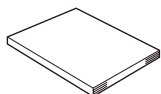

Ce kit comprend également le cadre de broderie de bord et la feuille de broderie pour vous permettre de mettre le tissu en place facilement.

- Cadre de broderie de bord
Etant donné que la zone de couture peut aisément être modifiée lorsque vous utilisez le cadre de bordure, il est possible de coudre un même motif en faisant simplement glisser le tissu. Vous pouvez broder une zone de 10 cm × 18 cm (env. 4 × 7 de pouce).

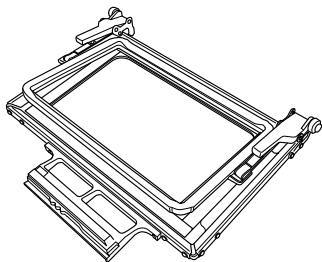

- Feuille de broderie
Cette feuille de broderie est destinée au cadre de broderie de bord. Elle est utilisée pour placer le tissu une fois que la zone à broder est déterminée.

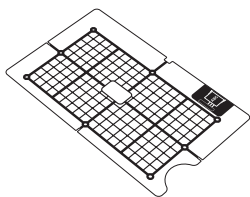



- Tableau de modification des couleurs du motif de broderie
Il s'agit du tableau de modification des couleurs pour les motifs de broderie sur CD-ROM. La plupart des motifs repris sur le CD-ROM sont soit des motifs simples, soit des motifs répétés.



Contenu du CD-ROM

- Assistant de délivrance de code de certification
- Manuel d'instructions du kit de mise à niveau version 4.0 (PDF)
 - * Adobe® Reader® ou Adobe® Acrobat® Reader® est requis pour consulter et imprimer le Manuel d'instructions.
- Application de mise à niveau pour la version 4.0
- Application de mise à jour pour la version 2.03 ou supérieure
 - * Pour la dernière version de 2.03 ou supérieure, visitez le site Web à l'adresse www.brother.com.
- Application de mise à jour pour la version 3.10 ou supérieure
 - * Pour la dernière version de 3.10 ou supérieure, visitez le site Web à l'adresse www.brother.com.
- Motifs de broderie pour le cadre de broderie de bord

Vue d'ensemble de l'installation

Commencez par lancer l'assistant de délivrance de code de certification figurant sur le CD-ROM fourni afin d'obtenir un code de certification. Puis, utilisez le code de certification pour installer l'application de mise à niveau pour la version 4.0 sur la machine à coudre. Dans les procédures,  indique les opérations effectuées avec la machine à coudre et  indique les opérations effectuées avec l'ordinateur.



[Etape 1] Notez le numéro de la machine (NO.).



[Etape 2] Insérez le CD-ROM dans le lecteur correspondant de l'ordinateur, puis lancez l'assistant de délivrance de code de certification.



[Etape 3] Suivez les instructions de l'assistant pour obtenir le code de certification.



[Etape 4] Installez l'application de mise à niveau pour la version 4.0 sur la machine à coudre.



[Etape 5] Redémarrez la machine à coudre, puis entrez le code de certification.



[Etape 6] Une fois la mise à niveau terminée, la machine à coudre redémarre automatiquement.

Vérification de l'environnement d'utilisation

Avant de lancer l'assistant de délivrance de code de certification, vérifiez que l'ordinateur à connecter répond aux conditions d'utilisation suivantes.

Ordinateur	PC IBM ou ordinateur compatible
Système d'exploitation	Windows® 98 Deuxième Edition* ¹ , Me, 2000, XP ou Vista
Lecteur de CD-ROM	Requis pour l'installation
Autres	Connexion Internet disponible et un seul port USB disponible (requis pour la mise à niveau de la machine à coudre)

* IBM est une marque déposée de IBM Corporation aux Etats-Unis et dans d'autres pays.

* Windows est une marque déposée de Microsoft Corporation aux Etats-Unis et dans d'autres pays.

*¹ Windows 98 Deuxième Edition nécessite un pilote. Téléchargez le pilote sur notre site Web (www.brother.com). Par ailleurs, seul Windows 98 Deuxième Edition peut utiliser le pilote.

Procédure d'installation

La procédure suivante décrit la mise à niveau de votre machine à coudre vers la version 4.0.



Remarque

- Si la procédure décrite ci-dessous n'est pas entièrement effectuée, il est impossible de mettre à niveau votre machine à coudre vers la version 4.0.
- L'accès à Internet est requis pour obtenir un code de certification.



1

Notez le numéro à 10 chiffres (numéro de la machine) affiché en regard de l'option "NO." à la P.3 de l'écran des réglages.



Remarque

Confirmez qu'il s'agit de la version 3.0 ou d'une version supérieure. Si ce n'est pas le cas, contactez votre revendeur agréé ou le service client Brother pour obtenir la version 3.0.



Mémo

- Ce numéro est entré une fois le code de certification obtenu ; veillez donc le noter correctement.



Numéro de la machine (NO.)

Numéro de la version



Remarque

- Le numéro qui apparaît en regard de l'option "NO." est différent du numéro de série (NO. SER.) figurant sur l'étiquette apposée à l'arrière de la machine à coudre.



- 2 Insérez le CD-ROM dans le lecteur correspondant de l'ordinateur.



Mémo

Dans Windows Vista, cliquez sur **Ouvrir le dossier et afficher les fichiers** lorsque la boîte de dialogue **Exécution automatique** s'affiche.



- 3 Ouvrez le lecteur D (si D est le lecteur de CD-ROM) de **Poste de travail**, double-cliquez sur , puis lancez l'**Assistant de délivrance de code de certification**.



Mémo

- Procédez comme suit pour lancer l'Assistant de délivrance de code de certification :
 - Cliquez sur **Démarrer**.
 - Cliquez sur **Exécuter**.

→ La boîte de dialogue **Exécuter** s'affiche.

- Tapez le chemin d'accès (D:\KeyWizard4.exe) au fichier d'application, puis cliquez sur **OK**.

→ La boîte de dialogue **Select Language (Sélectionner une langue)** s'affiche automatiquement.



- 4 Sélectionnez la langue souhaitée, puis cliquez sur **OK**.



→ L'**Assistant de délivrance de code de certification version 4.0** apparaît.



- 5 Lisez les informations qui s'affichent, puis cliquez sur **Suivant**.

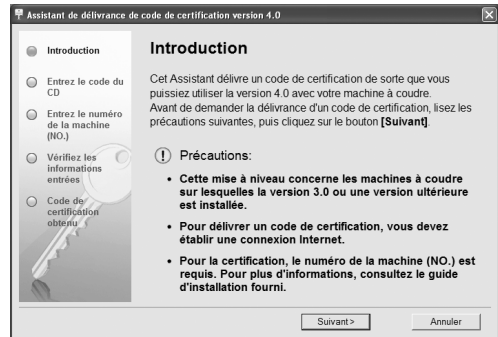

- 6 Tapez le code du CD à 15 chiffres figurant sur l'étiquette apposée sur le boîtier du CD du kit de mise à niveau, puis cliquez sur **Suivant**.



Si le message suivant s'affiche

Vérifiez les points suivants. Pour fermer le message, cliquez sur **OK**.

- Des symboles ou des caractères autres que des lettres et des numéros ont-ils été entrés ?
- Le chiffre "1" ou la majuscule "I" a-t-elle été entrée de manière incorrecte ?
- Le chiffre "0" ou la majuscule "O" a-t-elle été entrée de manière incorrecte ?

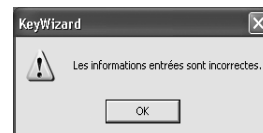



- 7 Tapez le numéro de la machine (NO.) noté à l'étape 1, puis cliquez sur **Suivant**.

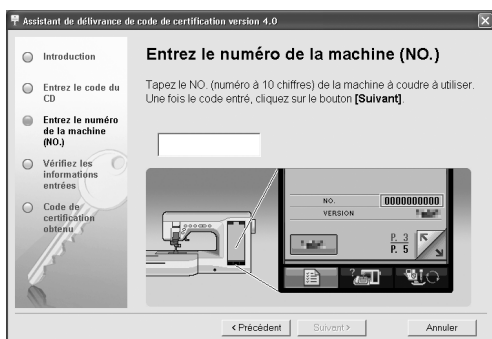

Si le message suivant s'affiche

Vérifiez que des symboles ou des caractères autres que des numéros n'ont pas été entrés. Pour fermer le message, cliquez sur **OK**.

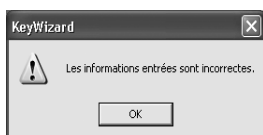

- 8 Vérifiez les informations entrées, puis cliquez sur **Certifier** si elles ont été entrées correctement. Pour modifier les informations entrées, cliquez sur **Précédent**.

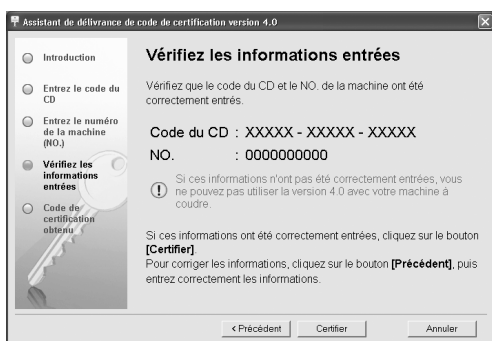

Remarque

- Pour obtenir un code de certification, vous devez établir une connexion Internet.

→ Connectez-vous au serveur de certification pour obtenir le code de certification de mise à niveau.

Si le message suivant s'affiche

Important :

- Le code du CD n'est valide que pour une seule machine à coudre. Vérifiez que le code du CD a été entré correctement, puis répétez la procédure à partir de l'étape 3. Pour fermer le message, cliquez sur **OK**.

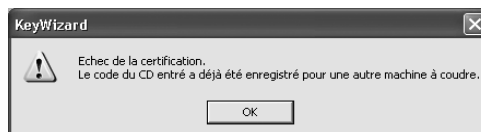

- Vérifiez que le code du CD et le numéro de la machine (NO.) ont été entrés correctement, puis répétez la procédure à partir de l'étape 3. Pour fermer le message, cliquez sur **OK**.

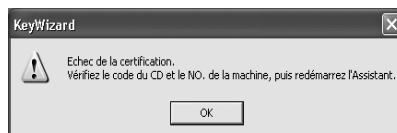

- Vérifiez la connexion Internet, puis cliquez de nouveau sur **Certifier**. Pour fermer le message, cliquez sur **OK**.

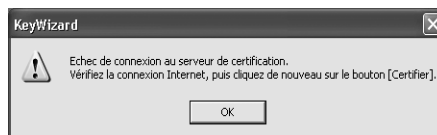

- 9 Notez le code de certification à 8 chiffres qui apparaît.



Remarque

- Après la mise à niveau de la machine à coudre vers la version 4.0, le code de certification doit être entré sur l'écran de la machine à coudre.



- 10 Cliquez sur **Terminer**.



- 11 Mettez la machine à coudre sous tension tout en appuyant sur la touche "Enfilage automatique".

Utilisez le support USB ou un ordinateur pour installer l'application de mise à niveau pour la version 4.0 sur la machine à coudre.

Si le **support USB** doit être utilisé, reportez-vous aux instructions suivantes.

Si un **ordinateur** doit être utilisé, reportez-vous à la page 23.

Utilisation du support USB pour exécuter

l'installation



- 12 Copiez le fichier **Application de mise à niveau vers la version 4.0** du CD-ROM sur le support USB.



Remarque

- Ne copiez pas un fichier autre que l'**application de mise à niveau pour la version 4.0** sur le support USB.



- 13 Appuyez sur  .

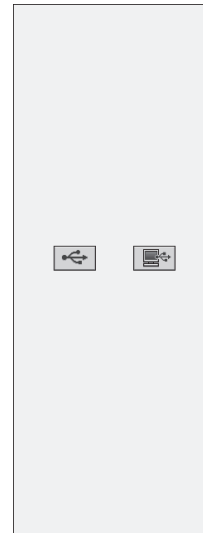

- 14 Insérez le support USB dans le connecteur de port USB de la machine.



15 Appuyez sur **CHARGER**.

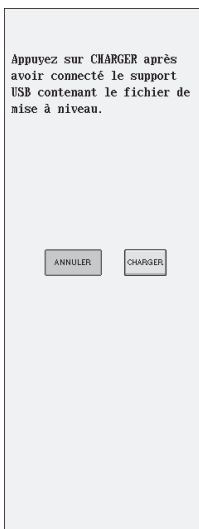

Remarque

Lorsque le message **“Mise à niveau terminée”** s'affiche, l'installation de l'application de mise à niveau est terminée.
(en cas d'erreur, un message s'affiche en rouge.)



16 Retirez le support USB.

Passez à l'étape 17 à la page 24.

Utilisation d'un ordinateur pour exécuter

l'installation



12 Appuyez sur

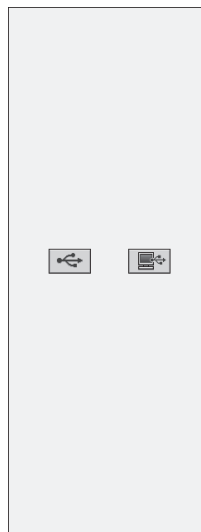

13 Branchez les connecteurs du câble USB dans les connecteurs de port USB correspondants de l'ordinateur et de la machine.

→ **Disque amovible** apparaît dans **Poste de travail**.



- 14 Copiez le fichier **Application de mise à niveau pour la version 4.0** du CD-ROM sur **Disque amovible**.

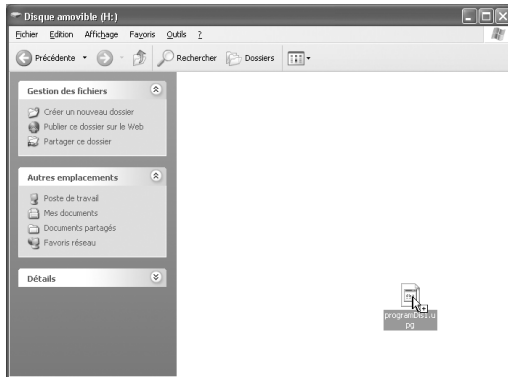

Remarque

Le message **“Connecté à un PC. Ne déconnectez pas le câble USB”** s'affiche sur l'écran LCD de la machine à coudre.



- 15 Appuyez sur **CHARGER**.

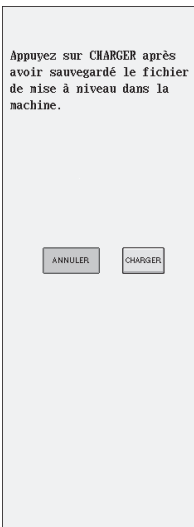

Remarque

Lorsque le message **“Mise à niveau terminée”** s'affiche, l'installation de l'application de mise à niveau est terminée. (en cas d'erreur, un message s'affiche en rouge.)



- 16 Débranchez le câble USB.



- 17 Mettez la machine à coudre hors tension, puis de nouveau sous tension.

→ L'écran suivant apparaît sur l'écran LCD.



- 18 Tapez le code de certification à 8 chiffres noté à l'étape 9, puis appuyez sur **REGLER**.



→ Une fois le numéro de certification de la version 4.0 défini, la machine à coudre redémarre automatiquement.



Remarque

- Si le message **Le code de certification est incorrect.** s'affiche, notez le numéro à 10 chiffres qui apparaît en regard de l'option “NO.” en haut de l'écran, puis répétez les étapes 2 à 10 pour obtenir le code de certification.
- Si vous avez perdu le code de certification, répétez les étapes 2 et 10 pour l'obtenir de nouveau.
- Lorsque vous essayez de mettre à niveau une machine de la version 2.0 vers la version 4.0, le message “Cette mise à niveau n'est pas applicable. Veuillez d'abord installer la version 3.0 sur la machine.” s'affiche. Utilisez le fichier du CD-ROM pour que la machine revienne à la version 2.0.
- Ce kit de mise à niveau (version 4.0) est destiné aux machines équipées de la version 3.0 ou supérieure. Une machine équipée de la version 2.0 ne peut faire l'objet d'une mise à niveau vers la version 4.0 avec ce kit de mise à niveau. Veuillez contacter votre revendeur agréé ou le service client Brother pour obtenir la version 3.0.

INHOUDSOPGAVE

Accessoires	26
Inhoud van de cd-rom	26
Installatieoverzicht	26
De bedieningsomgeving controleren	27
Installatieprocedure	27

Accessoires

Controleer of de volgende artikelen aanwezig zijn. Als er iets ontbreekt of beschadigd is, neem dan contact op met de officiële dealer of de klantenservice van Brother.

- Cd-rom (voor details over de inhoud, zie het volgende gedeelte.)



- Installatiegids (deze gids)

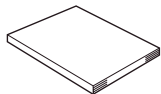

Bovendien omvat dit pakket het randborduurraam en het borduurvel om de stof gemakkelijk in de ring te plaatsen.

- Randborduurraam
Aangezien het naaigebied gemakkelijk kan worden gewijzigd wanneer u het randborduurraam gebruikt, kunt u herhaalde patronen naaien door de stof gewoon te schuiven. U kunt een gebied van 10 cm x 18 cm (ca. 4 inch x 7 inch) borduren.

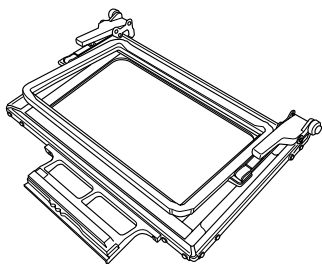

- Borduurvel
Dit borduurvel is bestemd voor het randborduurraam. Hiermee plaatst u de stof nadat u de borduurlocatie hebt vastgesteld.

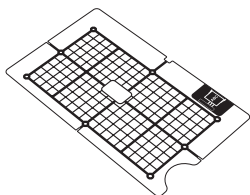

- Kleurwijzigingstabel voor de borduurpatronen
Dit is de kleurwijzigingstabel voor de borduurpatronen op de cd-rom. De meeste patronen op de cd-rom zijn enkele patronen of herhaalpatronen.

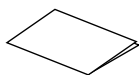



Inhoud van de cd-rom

- Wizard uitgifte certificatiesleutel
- Handleiding upgradepakket versie 4.0 (PDF)
 - * U hebt Adobe® Reader® of Adobe® Acrobat® Reader® nodig om de handleiding te bekijken en af te drukken.
- Upgrade-applicatie voor versie 4.0
- Update-applicatie voor versie 2.03 of later
 - * Voor de nieuwste versie van 2.03 of later, bezoek www.brother.com.
- Update-applicatie voor versie 3.10 of later
 - * Voor de nieuwste versie van 3.10 of later, bezoek www.brother.com.
- Borduurpatronen voor randborduurraam

Installatieoverzicht

Met de Wizard uitgifte certificatiesleutel op de cd-rom haalt u de certificatiesleutel op. Met de certificatiesleutel installeert u de upgrade-applicatie voor versie 4.0 op de naaimachine.

In de procedures geeft  aan dat bewerkingen worden uitgevoerd met de naaimachine en  dat bewerkingen worden uitgevoerd met de computer.



[Stap 1] Noteer het naaimachinenummer (NO.).



[Stap 2] Plaats de cd-rom in het cd-romstation van de computer en start de Wizard uitgifte certificatiesleutel.



[Stap 3] Volg de aanwijzingen van de wizard om de certificatiesleutel op te halen.



[Stap 4] Installeer de upgrade-applicatie voor versie 4.0 op de naaimachine.



[Stap 5] Start de naaimachine opnieuw op en typ de certificatiesleutel in.



[Stap 6] Wanneer u de upgrade hebt voltooid, start de naaimachine automatisch opnieuw op.

De bedieningsomgeving controleren

Alvorens u de Wizard uitgifte certificatiesleutel start, controleert u of de computer voldoet aan de volgende vereisten.

Computer	IBM-pc of compatibele computer
Besturingssysteem	Windows® 98SE* ¹ , Me, 2000, XP of Vista
Cd-rom-station	Vereist voor installatie
Andere vereisten	Internetverbinding en één beschikbare USB-poort (vereist voor het upgraden van de naaimachine)

* IBM is een gedeponeerd handelsmerk van IBM Corporation in de Verenigde Staten en andere landen.

* IBM is een gedeponeerd handelsmerk van Microsoft Corporation in de Verenigde Staten en andere landen.

¹ Windows 98SE vereist een stuurprogramma. Download het stuurprogramma van onze website (www.brother.com). Bovendien kunt u het stuurprogramma alleen gebruiken met Windows 98 Second Edition.

Installatieprocedure

In onderstaande procedure wordt beschreven hoe u een upgrade van uw naaimachine naar versie 4.0 uitvoert.



Opmerking

- Als u onderstaande procedure niet volledig uitvoert, kunt u de upgrade naar versie 4.0 niet voltooien.
- U hebt een internetverbinding nodig om de certificatiesleutel op te halen.



1

Noteer het 10-cijferige nummer (machinenummer) dat wordt weergegeven naast NO. op P.3 van het instellingscherm.



Opmerking

Controleer of het versie 3.0 of later is. Als het niet versie 3.0 of later is, neem dan contact op met uw officiële dealer of de klantenservice van Brother om versie 3.0 te verkrijgen.



Memo

- Let op dat u dit nummer juist noteert, aangezien u dit nummer intypt om de certificatiesleutel op te halen.

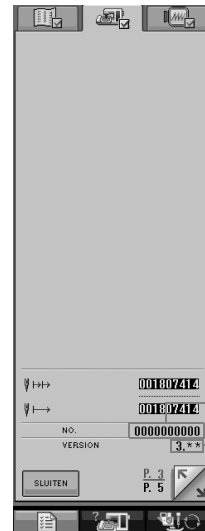

Machinenummer (NO.)

Versienummer



Opmerking

- Het nummer dat verschijnt naast NO. is niet hetzelfde als het serienummer (SER. NO.) op het etiket op de achterkant van de naaimachine.



- 2 Plaats de cd-rom in het cd-romstation van de computer.



Memo

In Windows Vista: wanneer het dialoogvenster **Automatisch afspelen** verschijnt, klikt u op **Map openen en bestanden weergeven**.



- 3 Open station D (wanneer station D het cd-rom-station is) of **Deze computer**, dubbelklik op , en start vervolgens de **Wizard uitgifte certificatiesleutel**.



Memo

- U kunt de Wizard uitgifte certificatiesleutel als volgt starten.
 1. Klik op **Start**.
 2. Klik op **Uitvoeren**.
- Het dialoogvenster **Uitvoeren** verschijnt.
3. Typ het pad (D:\KeyWizard4.exe) naar het applicatiebestand en klik vervolgens op **OK**.

→ Het dialoogvenster **Select Language (Selecteer taal)** verschijnt automatisch.



- 4 Selecteer de gewenste taal en klik vervolgens op **OK**.



→ **Wizard uitgifte certificatiesleutel versie 4.0** verschijnt.



- 5 Lees de informatie die verschijnt en klik op **Volgende**.

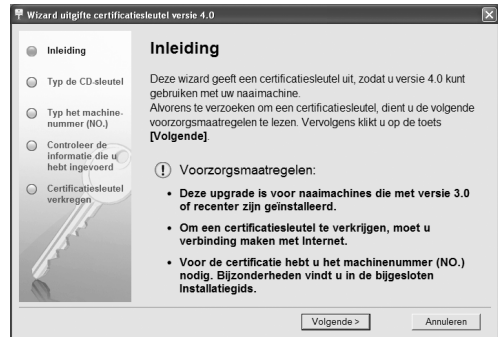

- 6 Typ de 15-cijferige cd-sleutel over van het etiket op het cd-doesje van het upgradepakket en klik op **Volgende**.



Als de volgende boodschap verschijnt

Controleer het volgende. Als u het bericht wilt sluiten, klikt u op **OK**.

- Hebt u andere symbolen of tekens ingevoerd dan letters of cijfers?
- Is het cijfer "1" of de hoofdletter "l" juist getypt?
- Is het cijfer "0" of de hoofdletter "O" juist getypt?





- 7 Typ het machinenummer (NO.) dat u hebt genoteerd in stap 1 en klik op **Volgende**.



Als de volgende boodschap verschijnt
Controleer of alleen cijfers - geen andere symbolen of letters - zijn opgegeven. Als u het bericht wilt sluiten, klikt u op **OK**.



- 8 Controleer de informatie die u hebt ingevoerd en klik op **Certificatie** als deze juist is ingevoerd. Als u de opgegeven informatie wilt wijzigen, klikt u op **Vorige**.

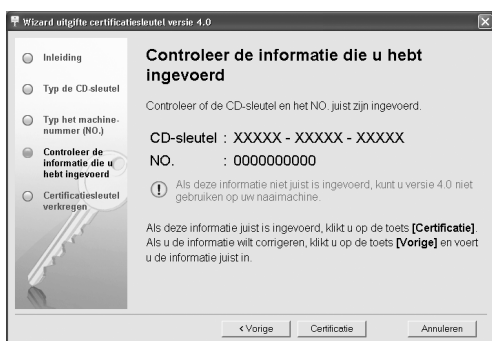

Opmerking

- U moet verbinding maken met Internet om de certificatiesleutel op te halen.

→ Maak verbinding met de certificatieserver en haal de upgradecertificatiesleutel op.

Als de volgende boodschap verschijnt

Belangrijk:

- De cd-sleutel is slechts geldig voor één naaimachine. Controleer of de cd-sleutel juist is ingevoerd en herhaal de procedure vanaf stap 3. Als u het bericht wilt sluiten, klikt u op **OK**.

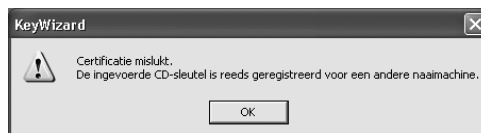

- Controleer of de cd-sleutel en het machinenummer (NO.) juist zijn ingevoerd en herhaal de procedure vanaf stap 3. Als u het bericht wilt sluiten, klikt u op **OK**.



- Controleer de internetverbinding en klik opnieuw op **Certificatie**. Als u het bericht wilt sluiten, klikt u op **OK**.

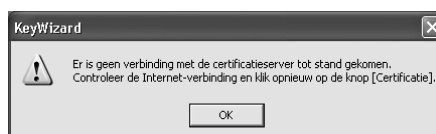

- 9 Noteer de 8-cijferige certificatiesleutel die verschijnt.



Opmerking

- Nadat u de upgrade van de naaimachine naar versie 4.0 hebt uitgevoerd, moet u de certificatiesleutel opgeven op het scherm van de naaimachine.



- 10 Klik op **Voltooien**.



- 11 Zet de machine aan terwijl u op de "Automatisch inrijgtoets" drukt.

Gebruik een USB-medium of een computer om de upgrade-applicatie voor versie 4.0 te installeren op de naaimachine.

Als u een **USB-medium** gebruikt, zie onderstaande aanwijzingen.

Als u een **computer** gebruikt, zie pagina 31.

Wanneer u een USB-medium gebruikt om de installatie uit te voeren 



- 12 Kopieer **Upgrade-applicatie voor versie 4.0** van de cd-rom naar het USB-medium.



Opmerking

- Kopieer geen ander bestand dan **Upgrade-applicatie voor versie 4.0** naar het USB-medium.



- 13 Druk op  .

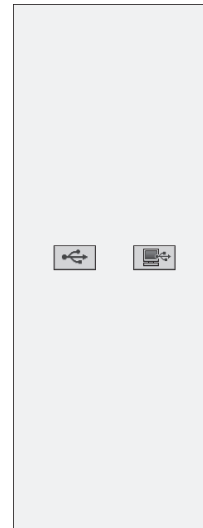

- 14 Plaats het USB-medium in de USB-poortansluiting op de machine.



15 Druk op **LADEN**.

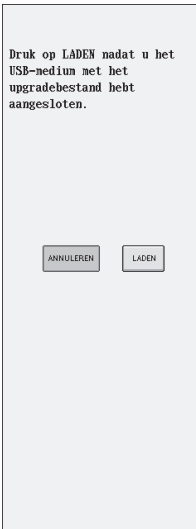

Opmerking

Wanneer het bericht **“Upgrade voltooid”** verschijnt, is de installatie van de upgrade-applicatie voltooid. (Als zich een fout heeft voorgedaan, verschijnt een foutmelding in rode letters.)



16 Verwijder het USB-medium.

Ga verder met stap 17 op pagina 32.

Wanneer u een computer gebruikt om de installatie uit te voeren



12 Druk op .

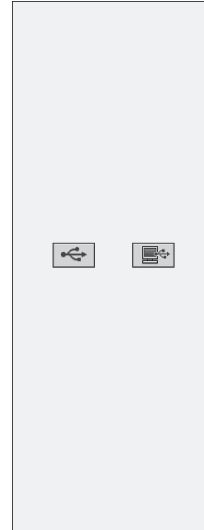

13 Sluit de USB-kabel aan op de betreffende USB-poortaanpluiging op de computer en op de machine.

→ **Verwisselbare schijf** verschijnt in **Deze computer**.



- 14 Kopieer **Upgrade-applicatie voor versie 4.0** van de CD-ROM naar **Verwisselbare schijf**.

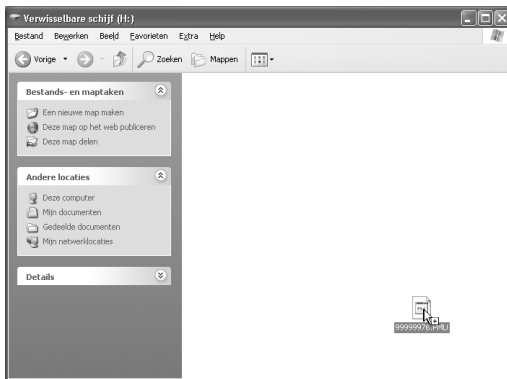

Opmerking

Het bericht **“Aangesloten op pc. Maak de USB-kabel niet los”**. verschijnt op de display van de naaimachine.



- 15 Druk op **LADEN**.



Opmerking

Wanneer het bericht **“Upgrade voltooid”**. verschijnt, is de installatie van de upgrade-applicatie voltooid. (Als zich een fout heeft voorgedaan, verschijnt een foutmelding in rode letters.)



- 16 Verwijder de USB-kabel.



- 17 Zet de naaimachine uit en weer aan.

→ Het volgende scherm verschijnt op de display:



- 18 Typ de 8-cijferige certificatiesleutel die u hebt genoteerd in stap 9 en druk vervolgens op



→ Wanneer het certificatienummer van versie 4.0 is ingesteld, start de naaimachine automatisch opnieuw op.



Opmerking

- Als het bericht **De certificatiesleutel is onjuist**. verschijnt, noteert u het 10-cijferige nummer naast NO. boven in het scherm en herhaalt u stap 9 t/m 10 om de certificatiesleutel op te halen.
- Als u de certificatiesleutel kwijt bent, herhaalt u stap 9 t/m 10 om de certificatiesleutel op te halen.
- Wanneer u probeert een machine met versie 2.0 wilt te upgraden naar versie 4.0, verschijnt het bericht “Deze upgrade is niet van toepassing. Voer eerst de upgrade tot versie 3.0 uit.”. Met het bestand op de cd-rom zet u de machine terug naar versie 2.0.
- Dit upgradepakket (versie 4.0) is een machine waarop versie 3.0 of later is geïnstalleerd. Een machine waarop versie 2.0 is geïnstalleerd kan met dit upgradepakket niet worden geactualiseerd naar versie 4.0. Neem contact op met uw officiële dealer of de klantenservice van Brother om versie 3.0 te verkrijgen.

SOMMARIO

Accessori.....	34
Contenuto del CD-ROM.....	34
Panoramica sull'installazione	34
Controllo dell'ambiente operativo	35
Procedura d'installazione	35

Accessori

Controllare che i seguenti componenti siano presenti nella fornitura. In caso di componenti mancanti o danneggiati, contattare il rivenditore o il Servizio di assistenza clienti Brother autorizzato.

- CD-ROM (per i dettagli sul contenuto, fare riferimento a quanto indicato di seguito)



- Guida all'installazione (la presente guida)

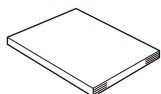

Inoltre, questo kit contiene il telaio da ricamo per bordi e il foglio per ricamo per un inserimento del tessuto più agevole.

- Telaio da ricamo per bordi
Poiché è possibile modificare agevolmente l'area di cucitura quando si utilizza il telaio da ricamo per bordi, si possono cucire disegni ripetuti facendo semplicemente scorrere il tessuto. È possibile ricamare un'area di 10 cm x 18 cm (circa 4 in x 7 in).

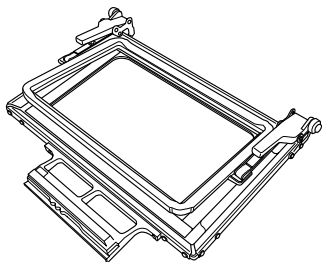

- Foglio per ricamo
Il foglio per ricamo si utilizza con il telaio da ricamo per bordi. Serve per posizionare il tessuto dopo aver determinato la posizione di ricamo.

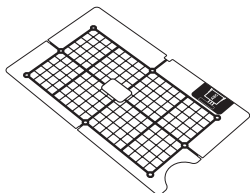

- Tabella di modifica dei colori del disegno da ricamo
È la tabella di modifica dei colori per i disegni da ricamo sul CD-ROM. La maggior parte dei disegni sul CD-ROM sono disegni singoli o ripetuti.





Contenuto del CD-ROM

- Procedura guidata per il rilascio del codice di autenticazione
- Manuale d'istruzioni del kit di aggiornamento per la versione 4.0 (PDF)
 - * Occorre disporre di Adobe® Reader® o Adobe® Acrobat® Reader® per visualizzare e stampare il Manuale d'istruzioni.
- Applicazione di aggiornamento per la versione 4.0
- Applicazione di aggiornamento per la versione 2.03 o successiva
 - * Per l'aggiornamento più recente della versione 2.03 o successiva, visitare il sito www.brother.com.
- Applicazione di aggiornamento per la versione 3.10 o successiva
 - * Per l'aggiornamento più recente della versione 3.10 o successiva, visitare il sito www.brother.com.
- Disegni da ricamo per telaio da ricamo per bordi

Panoramica sull'installazione

Innanzitutto, utilizzare la Procedura guidata per il rilascio del codice di autenticazione contenuta nel CD-ROM allegato per ottenere un codice di autenticazione. Quindi, utilizzare il codice di autenticazione per installare l'applicazione di aggiornamento per la versione 4.0 sulla macchina da cucire.

Nella procedura,  indica le operazioni eseguite con la macchina da cucire, mentre  indica le operazioni eseguite con il computer.



[Passaggio 1] Annotare il numero di macchina (NO.).



[Passaggio 2] Inserire il CD-ROM nell'unità CD-ROM del computer e avviare la Procedura guidata per il rilascio del codice di autenticazione.



[Passaggio 3] Seguire le indicazioni della procedura guidata per ottenere il codice di autenticazione.



[Passaggio 4] Installare l'applicazione di aggiornamento per la versione 4.0 sulla macchina da cucire.



[Passaggio 5] Riavviare la macchina da cucire e inserire il codice di autenticazione.



[Passaggio 6] Una volta terminato l'aggiornamento, la macchina da cucire si riavvia automaticamente.

Controllo dell'ambiente operativo

Prima di avviare la Procedura guidata per il rilascio del codice di autenticazione, controllare che il computer da collegare sia conforme alle seguenti condizioni operative.

Computer	PC IBM o computer compatibile
Sistema operativo	Windows® 98SE* ¹ , Me, 2000, XP o Vista
Unità CD-ROM	Necessaria per l'installazione
Varie	Disponibilità di una connessione Internet e di una porta USB libera (necessarie per l'aggiornamento della macchina da cucire)

* IBM è un marchio di fabbrica registrato di IBM Corporation negli Stati Uniti e in altri Paesi.

* Windows è un marchio di fabbrica registrato di Microsoft Corporation negli Stati Uniti e in altri Paesi.

*¹ Windows 98SE richiede un driver. Scaricare il driver dal nostro sito Web (www.brother.com). Inoltre, solo Windows 98 Second Edition può utilizzare il driver.

Procedura d'installazione

La seguente procedura descrive come aggiornare la macchina da cucire alla versione 4.0.



Nota

- Se non si completa la procedura descritta di seguito, non è possibile aggiornare la macchina da cucire alla versione 4.0.
- Per ottenere il codice di autenticazione occorre un accesso a Internet.



1

Annotare il numero di 10 cifre (numero di macchina) visualizzato vicino a "NO." in P.3 della schermata delle impostazioni.



Nota

Confermare che la versione utilizzata è 3.0 o successiva. In caso contrario, contattare il rivenditore o il Servizio di assistenza clienti Brother autorizzato per richiedere la versione 3.0.



Promemoria

- Poiché occorre inserire questo numero quando si ottiene il codice di autenticazione, assicurarsi di averlo annotato correttamente.



Numero di macchina (NO.)

Numero di versione



Nota

- Il numero visualizzato vicino a "NO." è diverso dal numero di serie (N. SER.) sull'etichetta applicata alla parte posteriore della macchina da cucire.



- 2 Inserire il CD-ROM nell'unità CD-ROM del computer.



Promemoria

In Windows Vista, quando viene visualizzata la finestra **AutoPlay**, fare clic su **Apri cartella per visualizzare i file**.



- 3 Aprire l'unità D (se l'unità D è l'unità CD-ROM) in **Risorse del computer**, fare doppio clic su  e avviare la **Procedura guidata per il rilascio del codice di autenticazione**.



Promemoria

- È possibile utilizzare la seguente procedura per avviare la Procedura guidata per il rilascio del codice di autenticazione.
 - Fare clic su **Start**.
 - Fare clic su **Esegui**.

→ Viene visualizzata la finestra di dialogo **Esegui**.

- Digitare il percorso (D:\KeyWizard4.exe) del file dell'applicazione e fare clic su **OK**.

→ La finestra di dialogo **Select Language (Seleziona lingua)** viene visualizzata automaticamente.



- 4 Selezionare la lingua desiderata e fare clic su **OK**.



→ Viene visualizzata la **Procedura guidata per il rilascio del codice di autenticazione della versione 4.0**.



- 5 Leggere le informazioni visualizzate e fare clic su **Avanti**.

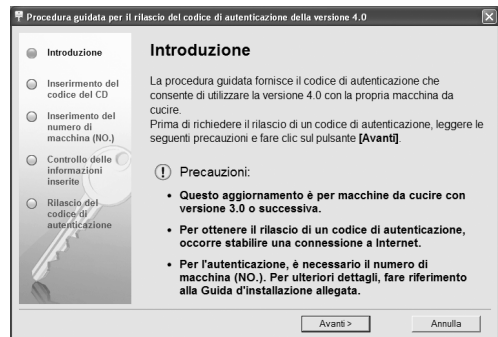

- 6 Digitare il codice del CD di 15 cifre indicato sull'etichetta apposta sulla custodia del CD del kit di aggiornamento e fare clic su **Avanti**.



Se viene visualizzato il seguente messaggio

Controllare le indicazioni riportate di seguito. Per chiudere il messaggio, fare clic su **OK**.

- Sono stati inseriti simboli o caratteri diversi da lettere e numeri?
- Il numero "1" o la lettera maiuscola "I" sono stati digitati correttamente?
- Il numero "0" o la lettera maiuscola "O" sono stati digitati correttamente?

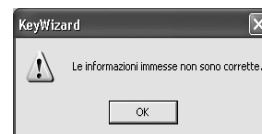



- 7 Digitare il numero di macchina (NO.) annotato al passaggio 1 e fare clic su **Avanti**.

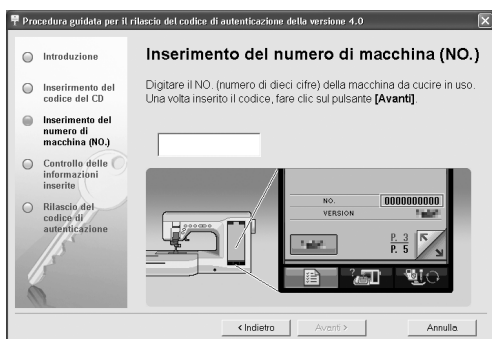

Se viene visualizzato il seguente messaggio

Controllare di aver inserito solo numeri e non simboli o caratteri diversi. Per chiudere il messaggio, fare clic su **OK**.

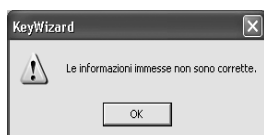

- 8 Controllare le informazioni inserite e fare clic su **Autentica** se sono state digitate correttamente. Per modificare le informazioni inserite, fare clic su **Indietro**.

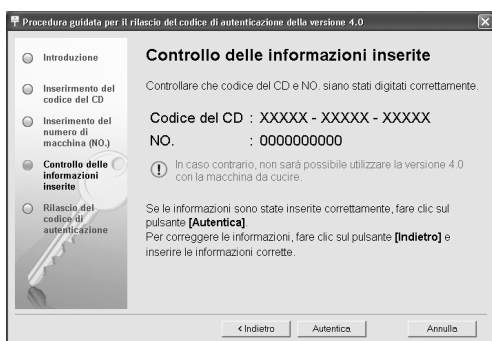

- Per ottenere il codice di autenticazione, occorre stabilire una connessione a Internet.

→ Collegarsi al server di autenticazione per ottenere il codice di autenticazione dell'aggiornamento.

Se viene visualizzato il seguente messaggio

Importante:

- Il codice del CD è valido per una sola macchina da cucire. Controllare che il codice del CD sia stato inserito correttamente e ripetere la procedura dal passaggio 3. Per chiudere il messaggio, fare clic su **OK**.

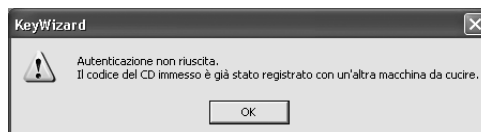

- Controllare che codice del CD e numero di macchina (NO.) siano stati inseriti correttamente e ripetere la procedura dal passaggio 3. Per chiudere il messaggio, fare clic su **OK**.

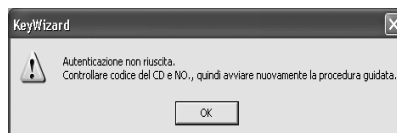

- Controllare la connessione Internet e fare nuovamente clic su **Autentica**. Per chiudere il messaggio, fare clic su **OK**.



- 9 Annotare il codice di autenticazione di 8 cifre visualizzato.

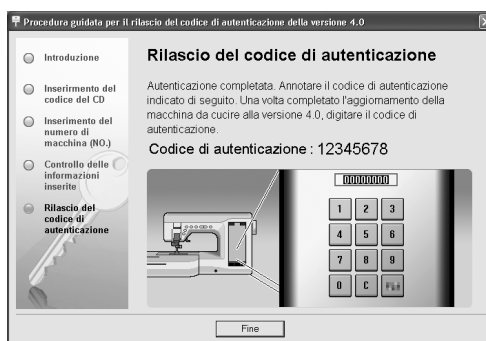

- Una volta completato l'aggiornamento della macchina da cucire alla versione 4.0, occorre digitare il codice di autenticazione nella schermata della macchina da cucire.



10 Fare clic su **Fine**.



11 Accendere la macchina da cucire premendo il pulsante "Infilatura automatica".

Utilizzare un supporto USB o un computer per installare l'applicazione di aggiornamento per la versione 4.0 sulla macchina da cucire.

Se si utilizza un **supporto USB**, fare riferimento alle seguenti istruzioni.

Se si utilizza un **computer**, fare riferimento alla pagina 39.

Utilizzo di un supporto USB per l'installazione



12 Copiare **Applicazione di aggiornamento per la versione 4.0** dal CD-ROM sul supporto USB.



Nota

- Non copiare file diversi da **Applicazione di aggiornamento per la versione 4.0** sul supporto USB.



13 Premere  .

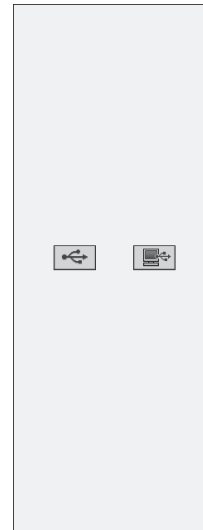

14 Inserire il supporto USB nel connettore della porta USB della macchina.



15 Premere **CARICA**.

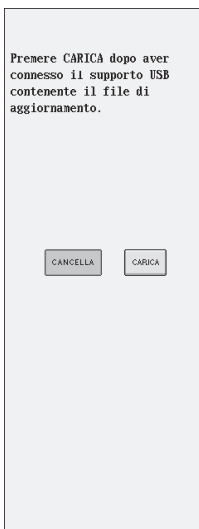

Nota

Quando viene visualizzato il messaggio **"Aggiornamento terminato"**, l'installazione dell'applicazione di aggiornamento è completata (in caso di errore, viene visualizzato un messaggio scritto in rosso).



16 Rimuovere il supporto USB.

Continuare con il passaggio 17 a pagina 40.

Utilizzo di un computer per l'installazione



12 Premere .

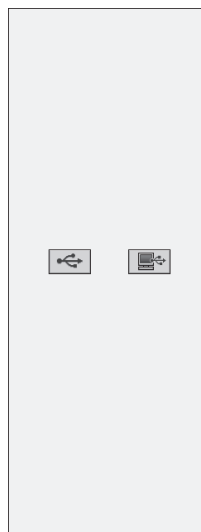

13 Inserire i connettori del cavo USB nei connettori delle porte USB corrispondenti sul computer e sulla macchina.

→ **Disco rimovibile** viene visualizzato in **Risorse del computer**.



- 14** Copiare **Applicazione di aggiornamento per la versione 4.0** dal CD-ROM su **Disco rimovibile**.

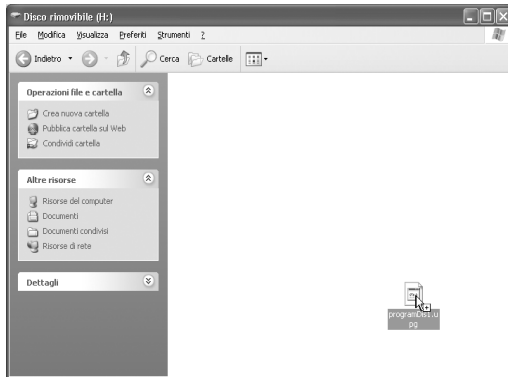

Nota

Sarà visualizzato il messaggio **“Connesso al PC. Non disconnettere il cavo USB.”** sul display LCD della macchina da cucire.



- 15** Premere **CARICA**.

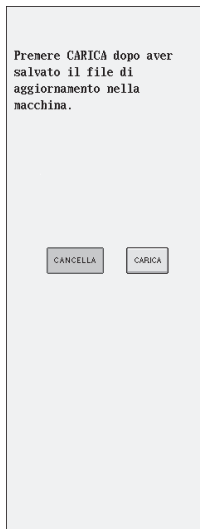

Nota

Quando viene visualizzato il messaggio **“Aggiornamento terminato”**, l'installazione dell'applicazione di aggiornamento è completata (in caso di errore, viene visualizzato un messaggio scritto in rosso).



- 16** Scollegare il cavo USB.



- 17** Spegner e riaccendere la macchina da cucire.
→ Viene visualizzata la schermata seguente sul display LCD.



- 18** Digitare il codice di autenticazione di 8 cifre annotato al passaggio **9** e premere **IMPOSTA**.



→ Una volta impostato il codice di autenticazione della versione 4.0, la macchina da cucire si riavvia automaticamente.



Nota

- Se viene visualizzato il messaggio **Il codice di autenticazione non è corretto.**, annotare il numero di 10 cifre visualizzato vicino a “NO.” sulla parte superiore della schermata e ripetere i passaggi da **9** a **10** per ottenere il codice di autenticazione.
- In caso di smarrimento del codice di autenticazione, ripetere i passaggi da **9** a **10** per ottenere il codice di autenticazione.
- Durante l'aggiornamento da una versione 2.0 alla versione 4.0, viene visualizzato il messaggio “Questo aggiornamento non è applicabile. È necessario prima aggiornare la macchina alla versione 3.0.”. Utilizzare il file sul CD-ROM per ripristinare la versione 2.0 sulla macchina.
- Questo kit di aggiornamento (versione 4.0) è per macchine su cui è installata la versione 3.0 o successiva. Questo kit non consente l'aggiornamento di una macchina dalla versione 2.0 alla versione 4.0. Contattare il rivenditore o il Servizio di assistenza clienti Brother autorizzato per richiedere la versione 3.0.

CONTENIDO

Accesorios.....	42
Contenido del CD-ROM.....	42
Introducción a la instalación	42
Comprobación del entorno de funcionamiento	43
Procedimiento de instalación	43

Accesorios

Compruebe que se proporcionan los siguientes componentes. Si falta o está dañado alguno, póngase en contacto con su distribuidor autorizado o con el Servicio de atención al cliente de Brother.

- CD-ROM (Para obtener más información sobre el contenido, consulte lo siguiente).



- Guía de instalación (esta guía)

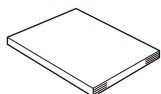

Además, este kit contiene el bastidor de bordado para bordes y la hoja de bordado para colocar fácilmente la tela.

- Bastidor de bordado para bordes
Dado que la zona de costura se puede cambiar fácilmente cuando se utiliza el bastidor de bordado para bordes, es posible coser patrones repetidos con sólo deslizar la tela. Puede bordarse una zona de 10 cm x 18 cm (aprox. 4 pulg. x 7 pulg.).

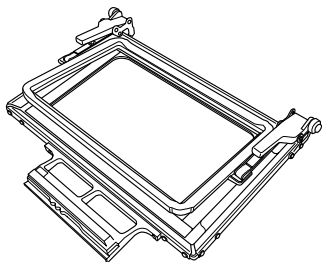

- Hoja de bordado
Esta hoja de bordado es para el bastidor de bordado para bordes. Sirve para colocar la tela una vez determinada la ubicación del bordado.

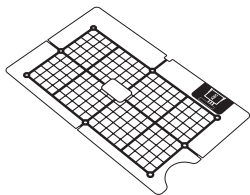

- Tabla de cambios de color para patrones de bordado
Es la tabla de cambios de color para los patrones de bordado incluidos en el CD-ROM. La mayoría de los patrones que contiene el CD-ROM son patrones individuales o repetidos.

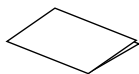



Contenido del CD-ROM

- Asistente para la emisión de claves de certificaciones
- Manual de instrucciones del kit de actualizaciones versión 4.0 (PDF)
 - * Es necesario Adobe® Reader® o Adobe® Acrobat® Reader® para poder ver e imprimir el Manual de instrucciones.
- Aplicación de actualización para la versión 4.0
- Aplicación de actualización para la versión 2.03 o posteriores
 - * Para la versión más reciente de 2.03 o posteriores, visite www.brother.com.
- Aplicación de actualización para la versión 3.10 o posteriores
 - * Para la versión más reciente de 3.10 o posteriores, visite www.brother.com.
- Patrones de bordado para el bastidor de bordado para bordes

Introducción a la instalación

En primer lugar, utilice el Asistente para la emisión de claves de certificaciones del CD-ROM que se incluye para obtener una clave de certificación. A continuación, utilice la clave de certificación para instalar la aplicación de actualización para la versión 4.0 de la máquina de coser.

En los procedimientos,  indica las operaciones realizadas con la máquina de coser y  indica las operaciones realizadas con el ordenador.



[Paso 1] Anote el número de la máquina (NO.).



[Paso 2] Inserte el CD-ROM en la unidad de CD-ROM del ordenador y, a continuación, inicie el Asistente para la emisión de claves de certificaciones.



[Paso 3] Siga las instrucciones del asistente para obtener la clave de certificaciones.



[Paso 4] Instale la aplicación de actualización para la versión 4.0 de la máquina de coser.



[Paso 5] Reinicie la máquina de coser y, a continuación, introduzca la clave de certificaciones.



[Paso 6] Cuando haya terminado la actualización, la máquina de coser se reinicia automáticamente.

Comprobación del entorno de funcionamiento

Antes de iniciar el Asistente para la emisión de claves de certificaciones, compruebe que el ordenador al que se va a conectar cumple las siguientes condiciones de funcionamiento.

Ordenador	PC IBM u ordenador compatible
Sistema operativo	Windows® 98SE* ¹ , Me, 2000, XP o Vista
Unidad de CD-ROM	Se necesita para la instalación
Otros	Disponible la conexión a Internet y un puerto USB disponible (necesario para actualizar la máquina de coser)

* IBM es una marca registrada de IBM Corporation en Estados Unidos y otros países.

* Windows es una marca registrada de Microsoft Corporation en Estados Unidos y otros países.

*¹ Windows 98SE necesita un controlador. Descargue el controlador de nuestro sitio Web (www.brother.com). Además, sólo se puede utilizar el controlador con Windows 98 Second Edition.

Procedimiento de instalación

En el siguiente procedimiento se describe cómo actualizar la máquina de coser a la versión 4.0.



Nota

- Si el procedimiento que se describe a continuación no se realiza totalmente, la máquina de coser no se podrá actualizar a la versión 4.0.
- Para obtener una clave de certificaciones, es necesario tener acceso a Internet.



1

Anote el número de 10 dígitos (número de la máquina) que se muestra al lado de "NO." en P.3 de la pantalla de ajustes.



Nota

Confirme que la versión es 3.0 o posterior. En caso contrario, póngase en contacto con su distribuidor autorizado o con el Servicio de atención al cliente de Brother para obtener la versión 3.0.



Recuerde

- Puesto que este número se va a introducir cuando se obtiene una clave de certificaciones, asegúrese de escribirlo correctamente.



Número de máquina (NO.)

Número de versión



Nota

- El número que aparece al lado de "NO." es diferente del número de serie (NO. SER.) de la etiqueta de la parte trasera de la máquina.



- 2 Inserte el CD-ROM en la unidad de CD-ROM del ordenador.



Recuerde

En Windows Vista, cuando aparezca el cuadro de diálogo **Reproducción automática**, haga clic en **Abrir la carpeta para ver los archivos**.



- 3 Abra la unidad D (cuando la unidad D es la unidad de CD-ROM) de **Mi PC**, haga doble clic en  y, a continuación, inicie el **Asistente para la emisión de claves de certificaciones**.



Recuerde

- El procedimiento siguiente se puede utilizar para iniciar el Asistente para la emisión de claves de certificaciones.
 - Haga clic en **Inicio**.
 - Haga clic en **Ejecutar**.

→ Aparecerá el cuadro de diálogo **Ejecutar**.

- Escriba la ruta (D:\KeyWizard4.exe) en el archivo de la aplicación y, a continuación, haga clic en **Aceptar**.

→ Aparece automáticamente el cuadro de diálogo **Select Language (Elegir idioma)**.



- 4 Seleccione el idioma deseado y, a continuación, haga clic en **OK**.



→ Aparece el **Asistente para la emisión de claves de certificaciones, versión 4.0**.



- 5 Lea la información que aparece y, a continuación, haga clic en **Siguiente**.

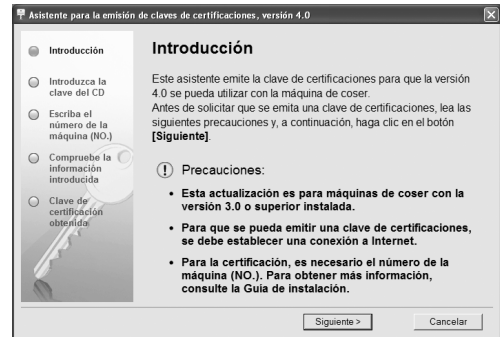

- 6 Escriba la clave del CD de 15 dígitos en la etiqueta que se proporciona con el estuche del CD del kit de actualizaciones y, a continuación, haga clic en **Siguiente**.



Si aparece el siguiente mensaje

Compruebe lo siguiente. Para cerrar el mensaje, haga clic en **Aceptar**.

- ¿Hay símbolos o caracteres introducidos que no son letras ni números?
- ¿Se ha introducido incorrectamente el número "1" o la letra mayúscula "I"?
- ¿Se ha introducido incorrectamente el número "0" o la letra mayúscula "O"?

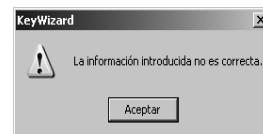



- 7 Escriba el número de la máquina (NO.) que se ha escrito en el paso 1 y, a continuación, haga clic en **Siguiente**.

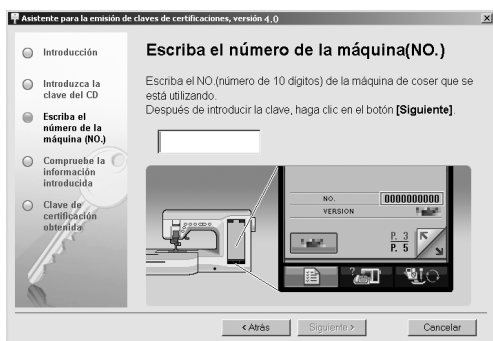

Si aparece el siguiente mensaje

Compruebe que no se han introducido símbolos ni caracteres que no sean números. Para cerrar el mensaje, haga clic en **Aceptar**.

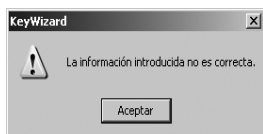

- 8 Compruebe la información introducida y, a continuación, haga clic en **Certificar** si se ha introducido correctamente. Para cambiar la información introducida, haga clic en **Atrás**.

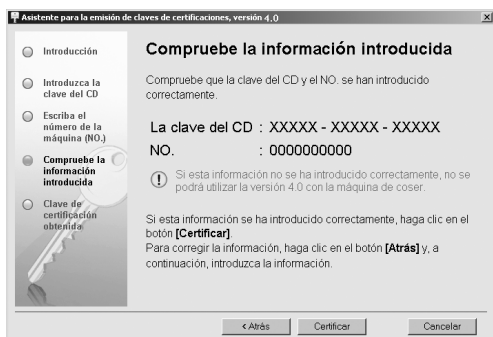

Nota

- Para que se pueda emitir una clave de certificaciones, se debe establecer una conexión a Internet.

→ Conecte con el servidor de certificaciones y, a continuación, obtenga la clave de certificaciones actualizada.

Si aparece el siguiente mensaje

Importante:

- La clave del CD es válida sólo para una máquina de coser. Compruebe que la clave del CD se ha introducido correctamente y, a continuación, repita el procedimiento desde el paso 3. Para cerrar el mensaje, haga clic en **Aceptar**.

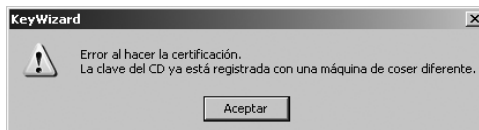

- Compruebe que la clave del CD y el número de la máquina (NO.) se han introducido correctamente y, a continuación, repita el procedimiento desde el paso 3. Para cerrar el mensaje, haga clic en **Aceptar**.

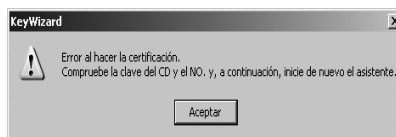

- Compruebe la conexión a Internet y, a continuación, haga clic de nuevo en **Certificar**. Para cerrar el mensaje, haga clic en **Aceptar**.

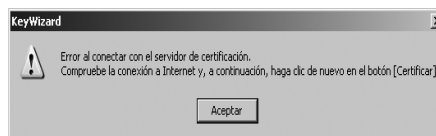

- 9 Escriba la clave de certificaciones de 8 dígitos que aparece.

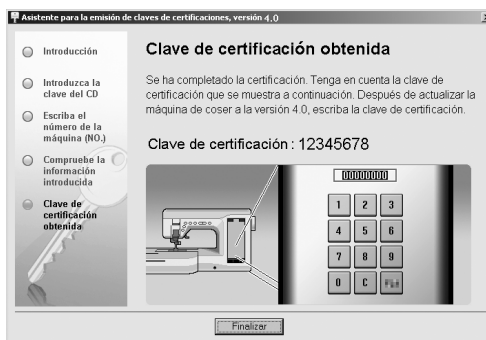

Nota

- Después de actualizar la máquina de coser a la versión 4.0, se debe escribir la clave de certificaciones en la pantalla de la máquina de coser.



10 Haga clic en **Finalizar**.



11 Encienda la máquina de coser mientras pulsa el botón de “enhebrado automático”.

Utilice un dispositivo USB o un ordenador para instalar la aplicación de actualización para la versión 4.0 de la máquina de coser.

Si se va a utilizar un **dispositivo USB**, consulte las instrucciones siguientes.

Si se va a utilizar un **ordenador**, consulte la página 47.

Al utilizar un dispositivo USB para realizar la instalación



12 Copie **Aplicación de actualización para la versión 4.0** de la unidad de CD-ROM al dispositivo USB.



Nota

- No copie ningún archivo que no sea **Aplicación de actualización para la versión 4.0** en el dispositivo USB.



13 Pulse  .

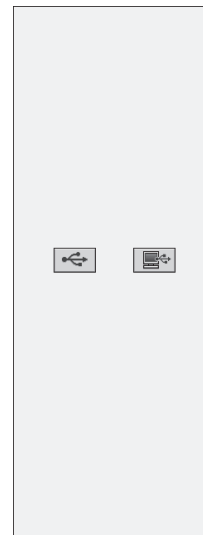

14 Inserte el dispositivo USB en el conector del puerto USB de la máquina.



15 Pulse **CARGAR**.



Nota

Cuando aparece el mensaje “**Actualización terminada.**”, la instalación de la aplicación de actualización se ha completado. (Si ha ocurrido algún error, aparecerá un mensaje en rojo).



16 Extraiga el dispositivo USB.

Siga con el paso 17 de la página 48.

Al utilizar un ordenador para realizar la instalación



12 Pulse .

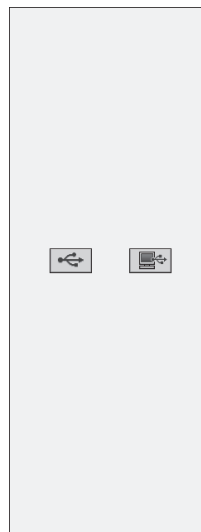

13 Conecte el cable USB a los correspondientes conectores USB en el ordenador y en la máquina.

→ **Disco extraíble** aparece en **Mi PC**.



- 14** Copie **Aplicación de actualización para la versión 4.0** de la unidad de CD-ROM a **Disco extraíble**.

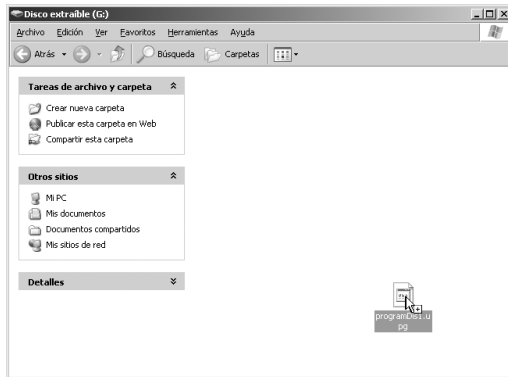

Nota

Aparece en la pantalla LCD de la máquina de coser el mensaje **“Conectado al PC. No desconecte el cable USB.”**.



- 15** Pulse **CARGAR**.

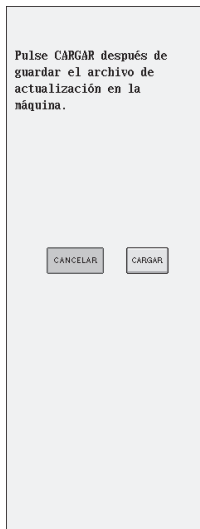

Nota

Quando aparece el mensaje **“Actualización terminada.”**, la instalación de la aplicación de actualización se ha completado. (Si ha ocurrido algún error, aparecerá un mensaje en rojo).



- 16** Desenchufe el cable USB.



- 17** Apague la máquina de coser y, a continuación, enciéndela de nuevo.
→ Aparecerá la pantalla siguiente en la LCD.



- 18** Escriba la clave de certificaciones de 8 dígitos que se ha escrito en el paso **9** y, a continuación, pulse **CONFIGURAR**.



→ Cuando se ha establecido el número de certificación de la versión 4.0, la máquina de coser se reinicia automáticamente.



Nota

- Si ha aparecido el mensaje **La clave de certificación no es correcta.**, escriba el número de 10-dígitos que aparece al lado de “NO.” en la parte superior de la pantalla y, a continuación, repita los pasos **2** a **10** para obtenerla.
- Si se ha perdido la clave de certificación, repita los pasos **2** a **10** para obtenerla.
- Al intentar actualizar una máquina con la versión 2.0 a la versión 4.0, aparece el mensaje “Esta actualización no es aplicable. Actualice primero la máquina a la versión 3.0.”. Utilice el archivo incluido en el CD-ROM para regresar a la versión 2.0.
- Este kit de actualizaciones (versión 4.0) es para máquinas que tengan instalada la versión 3.0 o posteriores. Con este kit de actualizaciones no es posible actualizar a la versión 4.0 una máquina con la versión 2.0. Póngase en contacto con su distribuidor autorizado o con el Servicio de atención al cliente de Brother para obtener la versión 3.0.

