



**Quick reference guide**  
**Kurzanleitung**  
**Guide de référence rapide**  
**Beknopte bedieningsgids**  
**Guida di riferimento rapido**  
**Guía de referencia rápida**

Refer to the operation manual for detailed instruction.

Also, there are differences in the keys and screens depending on the display language. In this guide, English screens are used for basic explanations.

Einzelheiten entnehmen Sie bitte der Bedienungsanleitung.

Je nachdem, welche Sprache für die Bildschirmanzeigen gewählt wurde, ergeben sich im Hinblick auf Bildschirmbilder eventuell Unterschiede.

Die grundlegende Bedienung der Maschine ist in dieser Anleitung am Beispiel von Bildschirmbildern mit englischem Text erklärt.

Pour les instructions détaillées, voir le mode d'emploi.

Par ailleurs, il y a des différences dans les touches et les écrans en fonction de la langue d'affichage.

Dans ce guide, les explications de base utilisent les écrans anglais.

Zie de gebruiksaanwijzing voor gedetailleerde instructies.

Er zijn verschillen in de toetsen en schermen afhankelijk van de ingestelde taal.

In de beschrijvingen in deze beknopte handleiding worden de Engelse schermen gebruikt.

Fare riferimento al manuale di impiego per istruzioni dettagliate.

Inoltre, ci sono differenze nei tasti e nelle schermate a seconda della lingua visualizzata.

In questa guida, le schermate in inglese sono usate per le spiegazioni basilari.

Consulte el manual de instrucciones para ver más detalles.

Además, dependiendo del idioma visualizado algunos botones y pantallas podrán ser diferentes.

En esta guía, para las explicaciones básicas se emplean pantallas en inglés.

<English display>  
<Englische Anzeige>  
<Affichage en anglais>  
<Engels scherm>  
<Schermata in inglese>  
<Visualización en inglés>

<Example: German>  
<Beispiel: Deutsch>  
<Exemple : allemande>  
<Voorbeeld: Duits>  
<Esempio: Tedesco>  
<Ejemplo: Alemán>

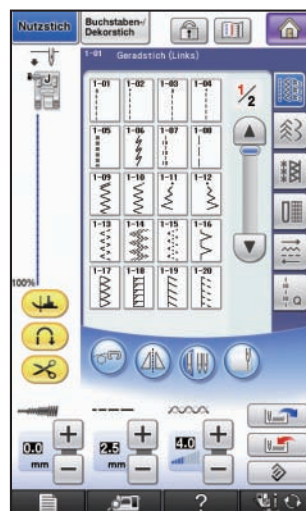
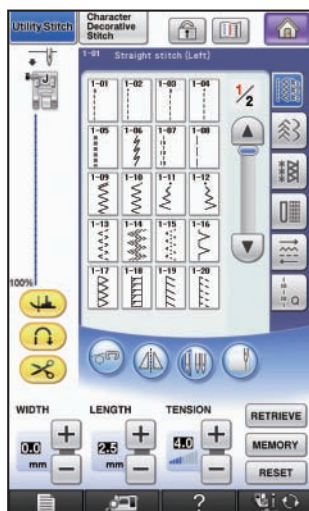

## Contents

- 2 Winding the Bobbin
- 4 Setting the Bobbin
- 5 Upper Threading
- 6 Preparing to Embroider
- 8 Selecting Stitch Patterns
  - 8 LCD Flow Chart
  - 9 Utility Stitches
  - 10 Character/Decorative Stitches
  - 10 Embroidery Patterns
  - 11 Embroidery Edit Patterns
  - 12 Others
- 13 Summary of Stitch Patterns
  - 13 Utility Stitches
  - 14 Character/Decorative Stitches
  - 20 Embroidery Patterns
- 30 Embroidery Pattern Color Change Table
  - 30 Embroidery patterns
  - 37 Brother "Exclusives" Vintage designs
  - 41 Brother "Exclusives" Monogram designs
  - 43 Brother "Exclusives" New European designs
  - 48 Brother "Exclusives" Japanese designs
  - 50 Brother "Exclusives" Quilt designs
  - 52 Greek alphabet patterns
  - 54 Floral alphabet patterns
  - 57 Utility embroidery patterns
- 61 Examples of Combinations
- 69 Color Thread Conversion Chart

## Table des matières

- 2 Bobinage de la canette
- 4 Mise en place de la canette
- 5 Enfilage supérieur
- 6 Préparation de la broderie
- 8 Sélection des configurations de point
  - 8 Organigramme de l'écran à cristaux liquides
  - 9 Points utilitaires
  - 10 Caractères/points décoratifs
  - 10 Motif de broderie
  - 11 Motifs de modification de broderie
  - 12 Autres
- 13 Sommaire des motifs de point
  - 13 Points utilitaires
  - 14 Caractères/points décoratifs
  - 20 Motif de broderie
- 30 Tableau de changement de couleur des motifs de broderie
  - 30 Motif de broderie
  - 37 Motifs classiques Brother « exclusifs »
  - 41 Motifs monogrammes Brother « exclusifs »
  - 43 Motifs européens nouveauté Brother « exclusifs »
  - 48 Motifs japonais Brother « exclusifs »
  - 50 Motifs piqués Brother « exclusifs »
  - 52 Motifs alphabet grec
  - 54 Motifs alphabet floral
  - 57 Motifs de broderie courants
- 61 Exemples de combinaisons
- 69 Tableau de conversion des fils de couleur

## Sommario

- 2 Avvolgimento della spolina
- 4 Impostazione della spolina
- 5 Infilatura superiore
- 6 Preparativi per il ricamo
- 8 Selezione degli schemi punto
  - 8 Schema di flusso LCD
  - 9 Punti utili
  - 10 Punti per caratteri/decorazioni
  - 10 Schemi di ricamo
  - 11 Schemi di modifica ricamo
  - 12 Altro
- 13 Sommario degli schemi punto
  - 13 Punti utili
  - 14 Punti per caratteri/decorazioni
  - 20 Schemi di ricamo
- 30 Tabella di cambiamento colori degli schemi di ricamo
  - 30 Schemi di ricamo
  - 37 Disegni Vintage "Esclusivi" Brother
  - 41 Disegni monogramma "Esclusivi" Brother
  - 43 Disegni novità europee "Esclusivi" Brother
  - 48 Disegni giapponesi "Esclusivi" Brother
  - 50 Disegni per trapuntatura "Esclusivi" Brother
  - 52 Disegni alfabeto greco
  - 54 Alfabeto floreale
  - 57 Disegni da ricamo utili
- 61 Esempi di combinazioni
- 69 Tabella di conversione dei fili colorati

## Inhalt

- 2 Aufspulen des Unterfadens
- 4 Einsetzen der Spule
- 5 Einfädeln des Oberfadens
- 6 Vorbereitung zum Sticken
- 8 Wahl des Nähmusters
  - 8 LCD-Übersichtsdiagramm
  - 9 Nutztische
  - 10 Buchstaben/Dekorative Stichmuster
  - 10 Stickmuster
  - 11 Editieren von Stickmustern
  - 12 Sonstiges
- 13 Nähmuster-Übersicht
  - 13 Nutztische
  - 14 Buchstaben/Dekorative Stichmuster
  - 20 Stickmuster
- 30 Stickmuster-Farbtabelle
  - 30 Stickmuster
  - 37 Brother-„Auswahl“: Klassische Designs
  - 41 Brother-„Auswahl“: Monogramdesigns
  - 43 Brother-„Auswahl“: Neue europäische Designs
  - 48 Brother-„Auswahl“: Japanische Designs
  - 50 Brother-„Auswahl“: Quilt designs
  - 52 Buchstabenmuster des griechischen Alphabets
  - 54 Blumenalphabet
  - 57 Nutztisch-Stickmuster
- 61 Kombinationsbeispiele
- 69 Stickgarn-Farbtabelle

## Inhoudsopgave

- 2 Spoel opwinden
- 4 Aanbrengen van het spoeltje
- 5 Inrijgen van de bovendraad
- 6 Voorbereidingen voor borduren
- 8 Kiezen van de steekpatronen
  - 8 LCD-stroomschema
  - 9 Naaisteken
  - 10 Letter/decoratieve steken
  - 10 Borduurpatronen
  - 11 Borduurbewerkingspatronen
  - 12 Overige
- 13 Overzicht van de steekpatronen
  - 13 Naaisteken
  - 14 Letter/decoratieve steken
  - 20 Borduurpatronen
- 30 Kleurwijzigingstabel voor de borduurpatronen
  - 30 Borduurpatronen
  - 37 "Exclusief" nostalgische ontwerpen van Brother
  - 41 "Exclusief" monogramontwerpen van Brother
  - 43 "Exclusief" nieuwe Europese ontwerpen van Brother
  - 48 "Exclusief" Japanse ontwerpen van Brother
  - 50 "Exclusief" quiltontwerpen van Brother
  - 52 Griekse alfabetpatronen
  - 54 Bloemletterpatronen
  - 57 Borduurnaaipatronen
- 61 Voorbeelden van combinaties
- 69 Omzettingstabel voor kleurgaren

## Contenido

- 2 Devanado de la bobina
- 4 Colocación de la bobina
- 5 Hilo superior
- 6 Preparativos para bordar
- 8 Selección de tipos de puntada
  - 8 Diagrama de flujo del LCD
  - 9 Puntadas útiles
  - 10 Puntadas de letras/decorativas
  - 10 Patrones de bordado
  - 11 Patrones de edición de bordado
  - 12 Otros
- 13 Resumen de tipos de puntada
  - 13 Puntadas útiles
  - 14 Puntadas de letras/decorativas
  - 20 Patrones de bordado
- 30 Tabla de cambio de color para patrones de bordado
  - 30 Patrones de bordado
  - 37 Diseños de época "exclusivos" de Brother
  - 41 Diseños de monogramas "exclusivos" de Brother
  - 43 Diseños de la Nueva Europa "exclusivos" de Brother
  - 48 Diseños japoneses "exclusivos" de Brother
  - 50 Diseños de acolchado "exclusivos" de Brother
  - 52 Costuras de caracteres alfabéticos griegos
  - 54 Patrones alfabéticos en motivo floral
  - 57 Patrones de bordado de utilidad
- 61 Ejemplos de combinaciones
- 69 Tabla de conversión de hilos de color



# Winding the Bobbin Bobinage de la canette Avvolgimento della spolina

# Aufspulen des Unterfadens Spoel opwinden Devanado de la bobina

Follow the numbered steps below in order. Refer to the operation manual for detailed instruction.  
Führen Sie die folgenden Schritte in der angegebenen Reihenfolge aus. Ausführliche Hinweise finden Sie in der Bedienungsanleitung.  
Suivez les étapes numérotées ci-dessous dans l'ordre. Consultez le manuel d'instructions pour des procédures détaillées.  
Voer de genummerde stappen uit in de juiste volgorde. Uitvoerige aanwijzingen vindt u in de bedieningshandleiding.  
Seguire i passaggi numerati nell'ordine riportato di seguito. Fare riferimento al manuale d'istruzioni per le istruzioni dettagliate.  
Realice los siguientes pasos numerados en el orden indicado. Para obtener instrucciones detalladas, consulte el manual de instrucciones.

Use only the enclosed bobbin or bobbins of the same type.  
Verwenden Sie nur die im Lieferumfang enthaltene Spule oder Spulen vom selben Typ.  
N'utilisez que la canette fournie ou des canettes du même type.  
Gebruik alleen de bijgeleverde spoel of spoelen van hetzelfde type.  
Utilizzare solo la spolina inclusa o spoline dello stesso tipo.  
Utilice sólo la bobina incluida o bobinas del mismo tipo.

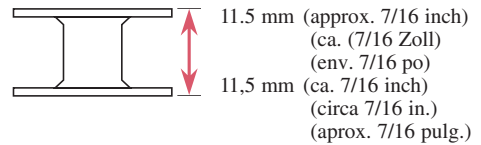

## Using the Supplemental Spool Pin

You can wind the bobbin during sewing.

## Verwendung des zusätzlichen Garnrollenstifts

Sie können den Unterfaden während des Nähens aufspulen.

## Utilisation du porte-bobine supplémentaire

Vous pouvez bobiner la canette pendant la couture.

## Gebruik van de klospen

U kunt de spoel opwinden tijdens het naaien.

## Utilizzo del portarocchetto supplementare

È possibile avvolgere la spolina durante la cucitura.

## Uso del portacarrete suplementario

Puede devanar la bobina mientras está cosiendo.

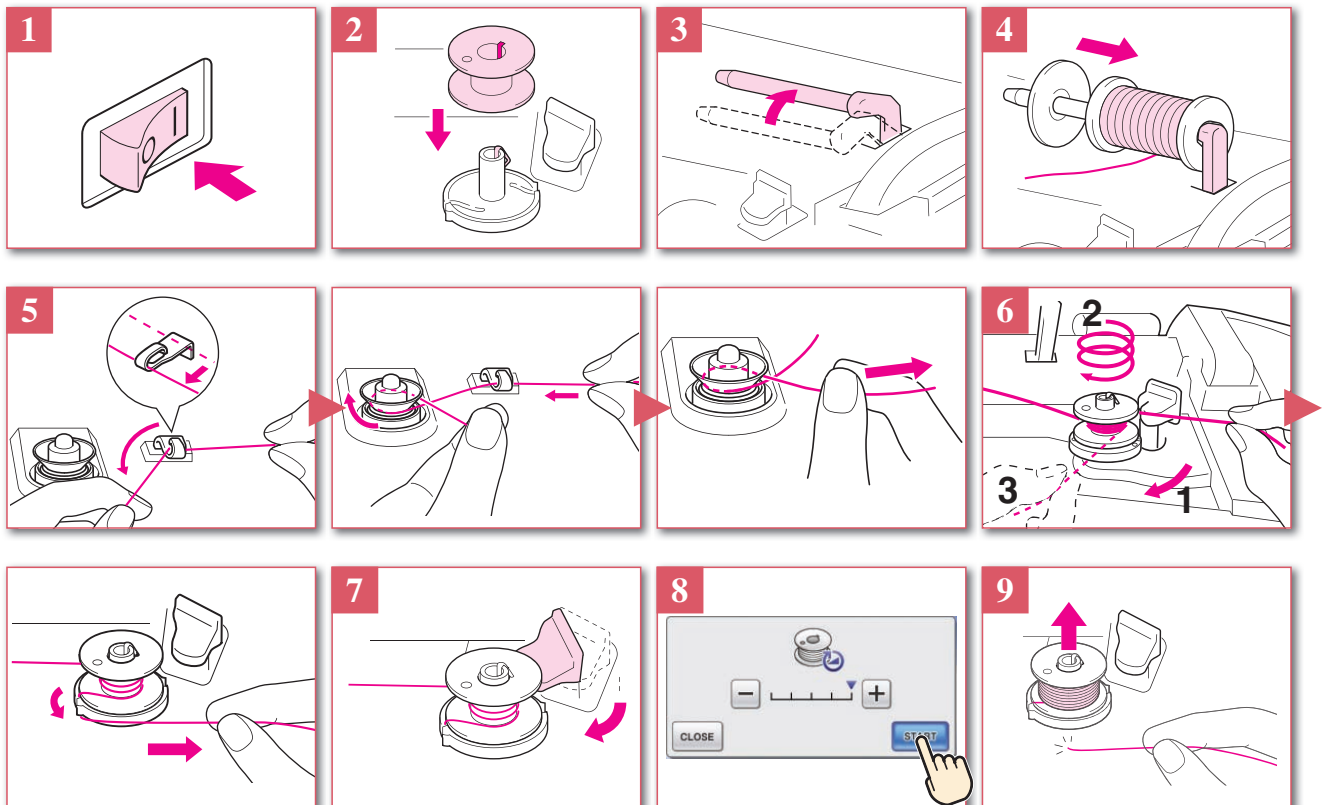
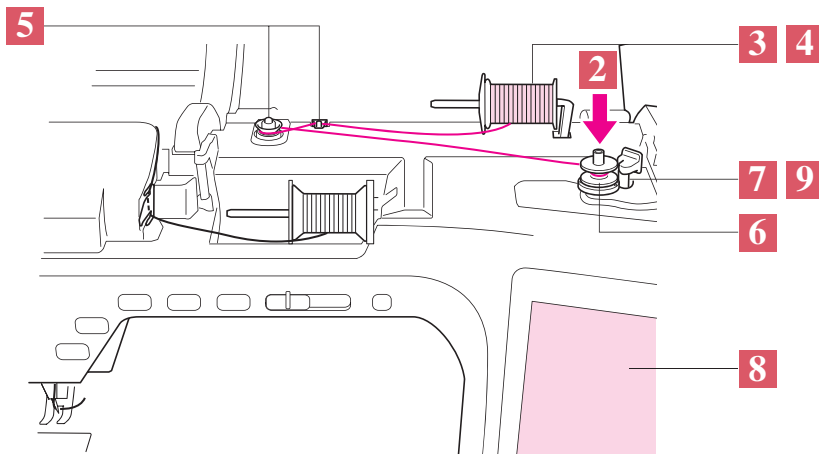





### Using the Spool Pin

You can use the main spool pin to wind the bobbin before sewing.

### Gebruik van de klossen

Voordat u gaat naaien kunt u met de hoofdklossen de spoel opwinden.

### Verwendung des Garnrollenstifts

Mit dem Hauptgarnrollenstift können Sie vor dem Nähen den Unterfaden aufspulen.

### Utilizzo del portarocchetto

È possibile utilizzare il portarocchetto principale per avvolgere la spolina prima di cucire.

### Utilisation du porte-bobine

Vous pouvez bobiner la canette avant de coudre à l'aide du porte-bobine principal.

### Uso del portacarrete

Puede utilizar el portacarrete principal para devanar la bobina antes de coser.

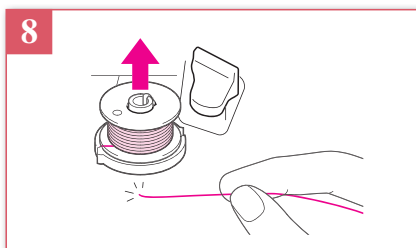
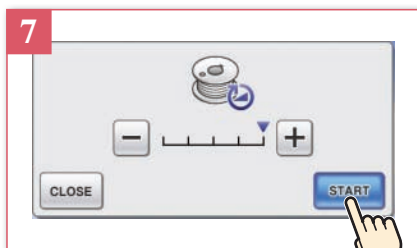
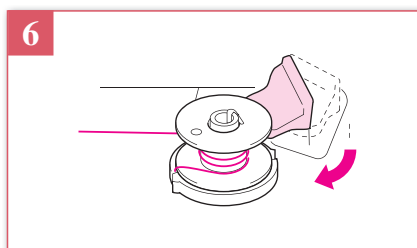
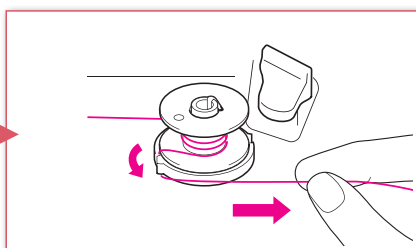
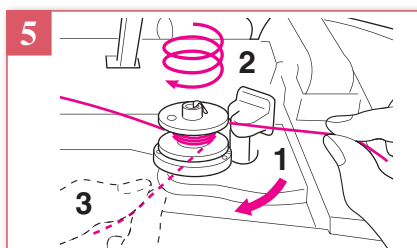
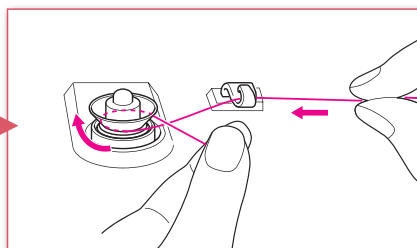
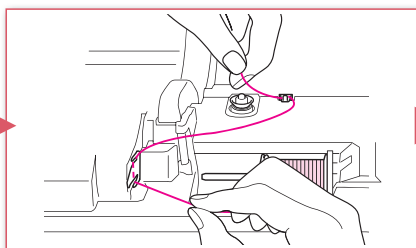
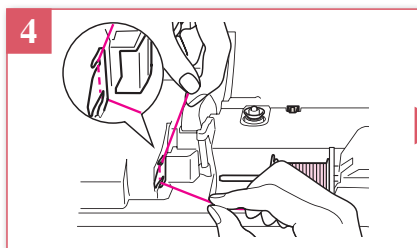
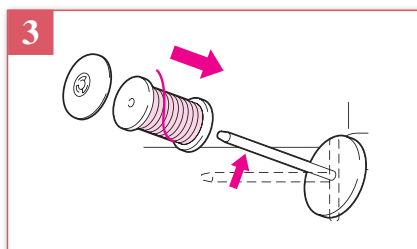
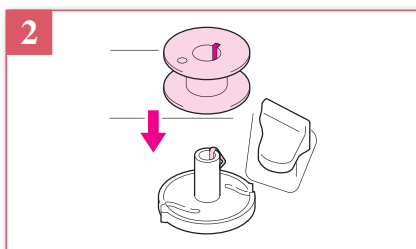
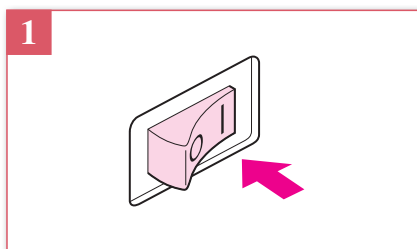
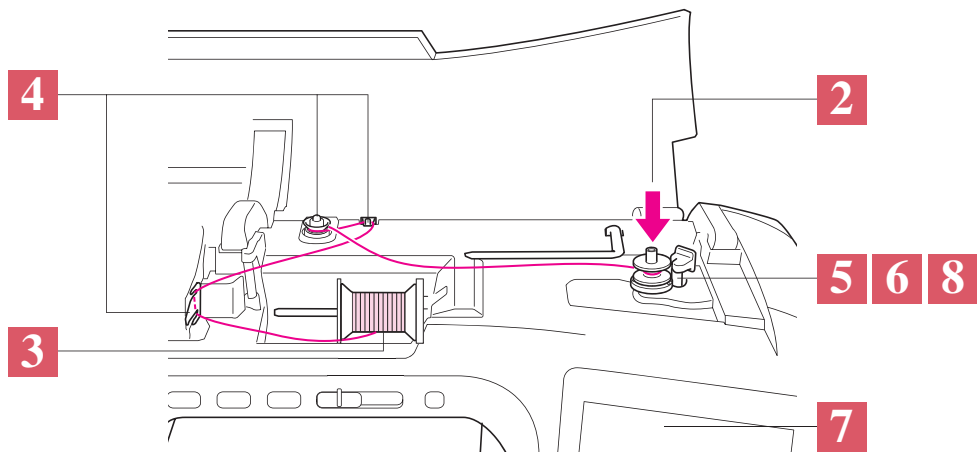

# Setting the Bobbin

## Mise en place de la canette

### Impostazione della spolina

# Einsetzen der Spule

## Aanbrengen van het spoeltje

### Colocación de la bobina

Refer to the operation manual for detailed instruction.

Einzelheiten hierzu entnehmen Sie bitte der Bedienungsanleitung.

Pour les instructions détaillées, voir le mode d'emploi.

Zie de gebruiksaanwijzing voor gedetailleerde instructies.

Fare riferimento al manuale di impiego per istruzioni dettagliate.

Consulte el manual de instrucciones para ver más detalles.

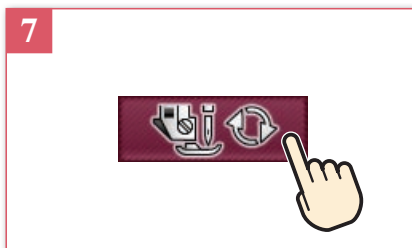
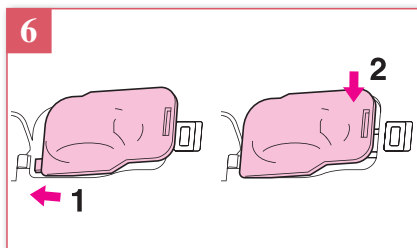
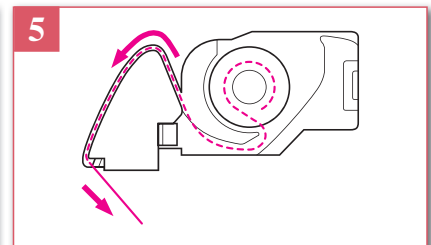
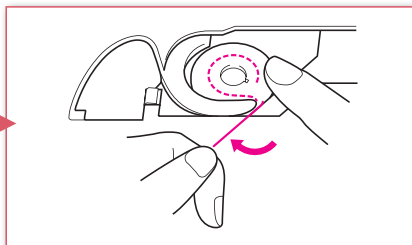
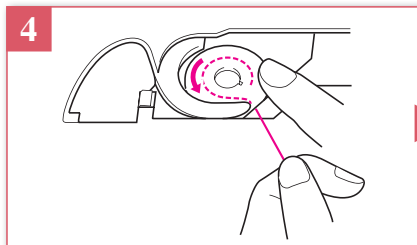
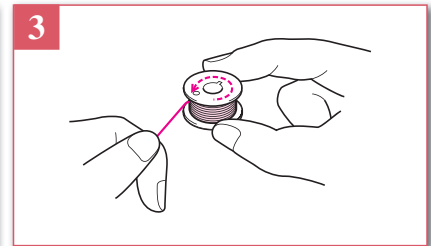
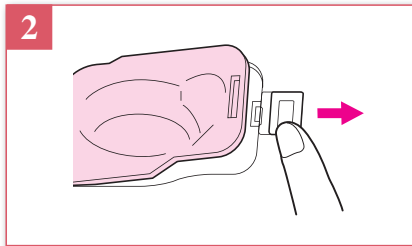
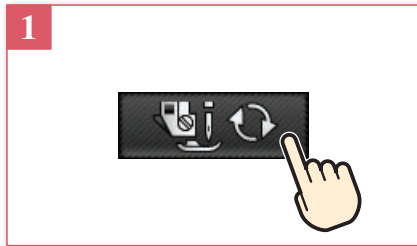

**Upper Threading**  
**Enfilage supérieur**  
**Infilatura superiore**

**Einfädeln des Oberfadens**  
**Inrijgen van de bovendraad**  
**Hilo superior**

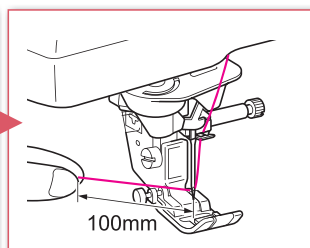
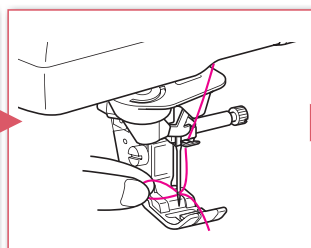
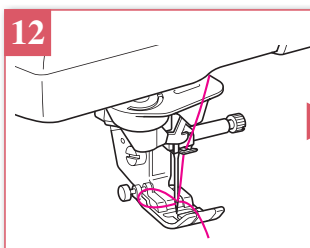
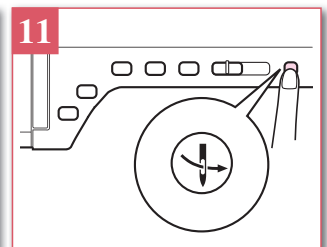
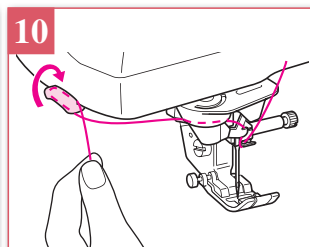
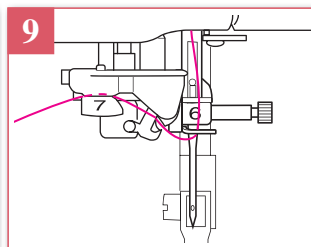
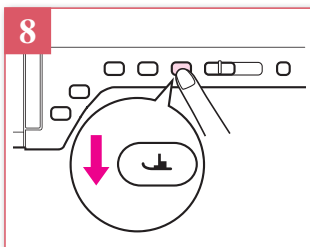
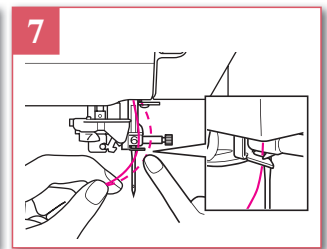
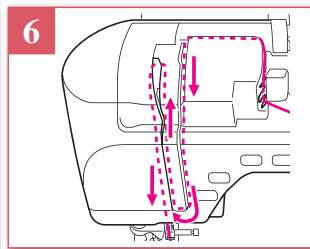
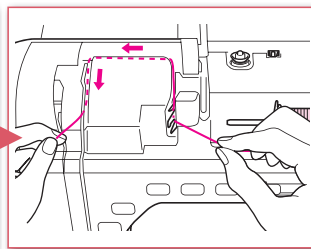
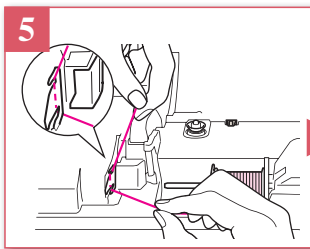
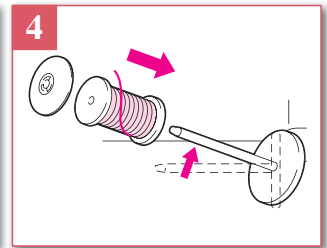
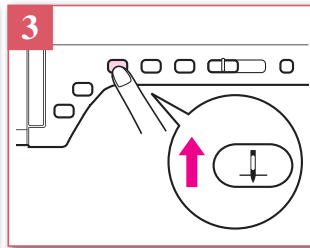
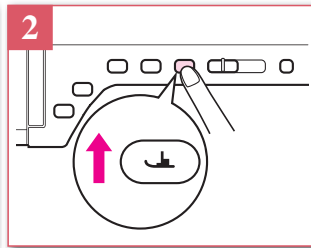
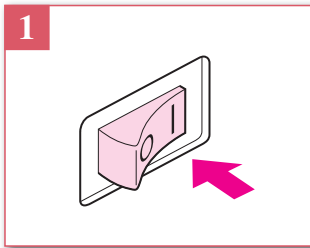
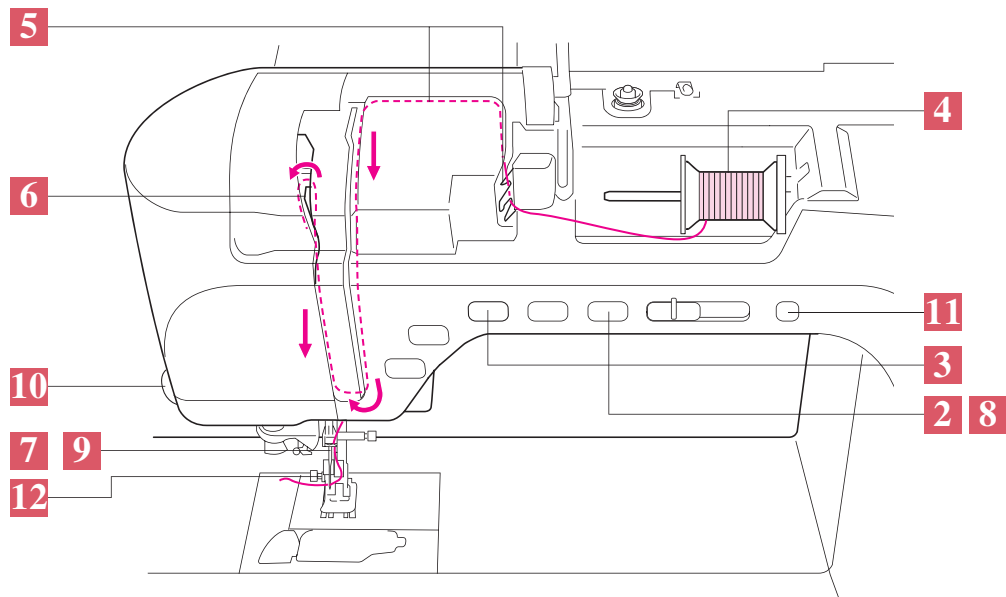



Preparing to Embroider  
 Préparation de la broderie  
 Preparativi per il ricamo

Vorbereitung zum Sticken  
 Voorbereidingen voor borduren  
 Preparativos para bordar

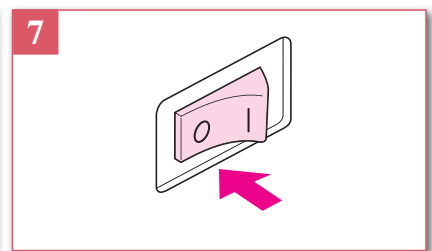
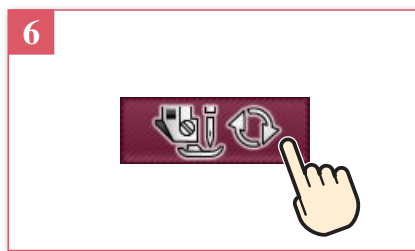
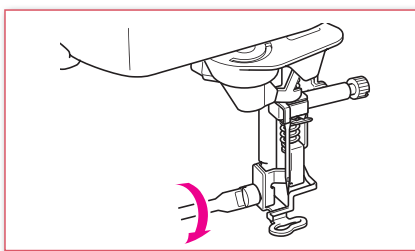
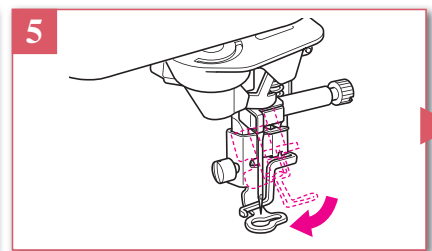
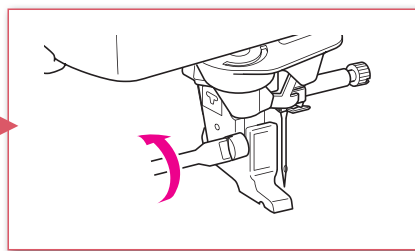
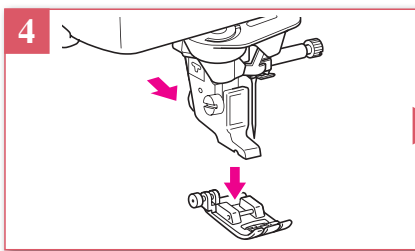
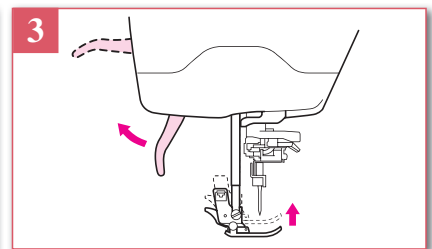
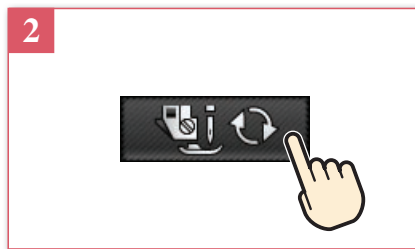
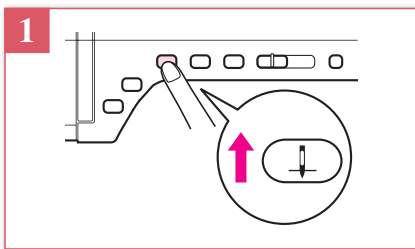
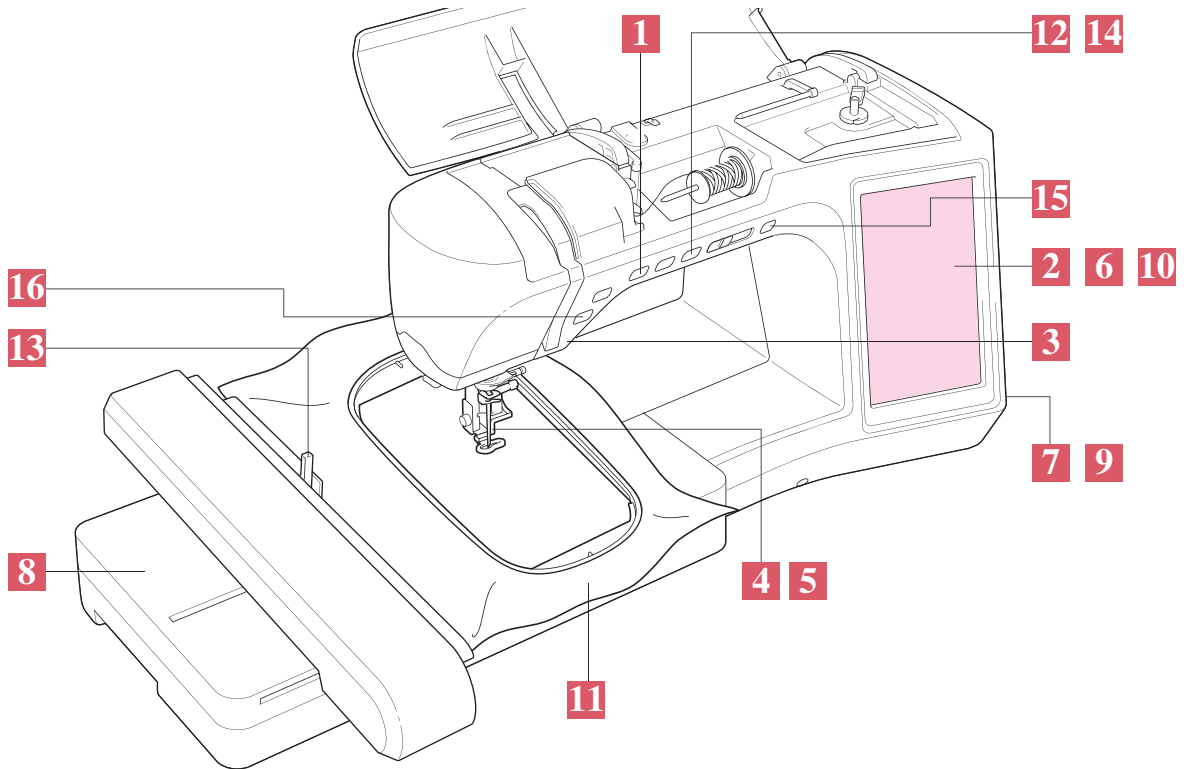

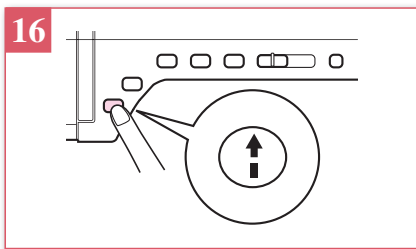
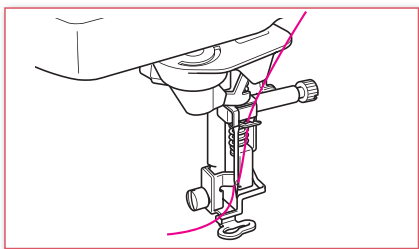
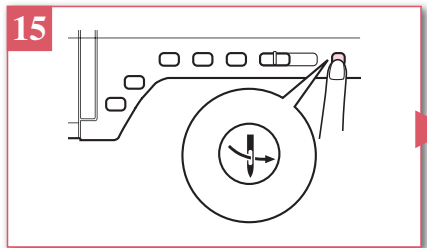
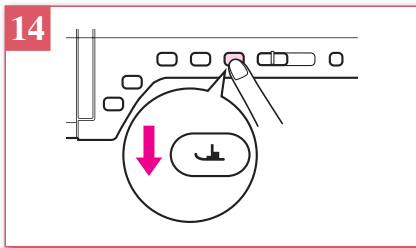
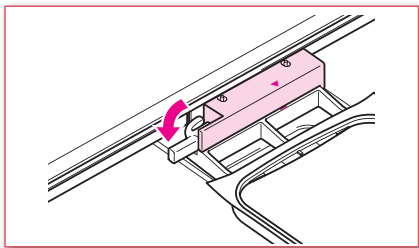
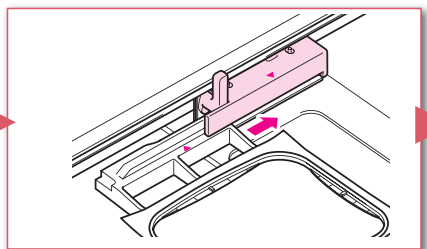
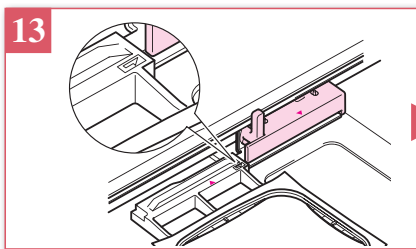
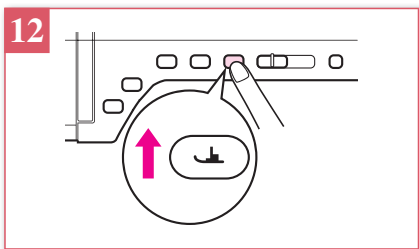
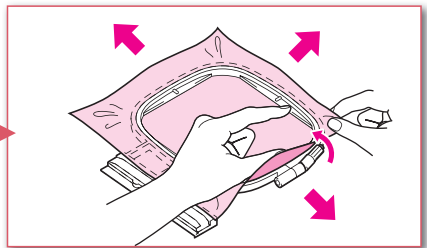
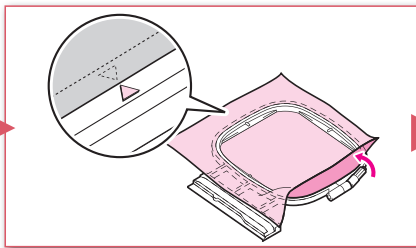
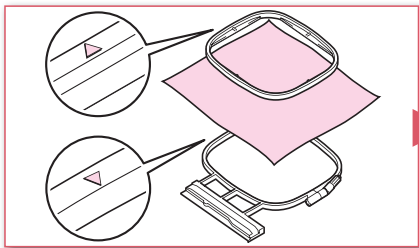
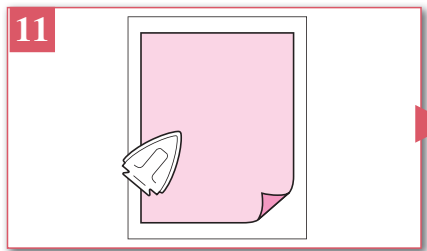
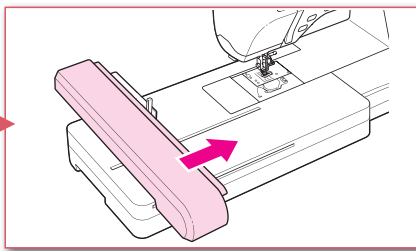
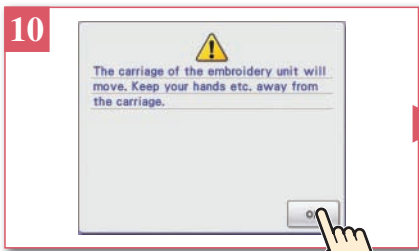
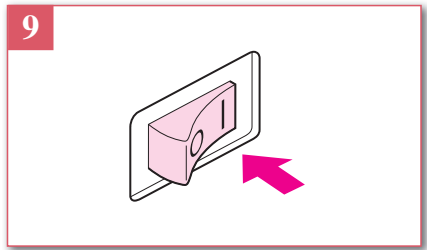
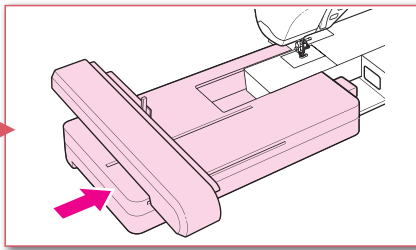
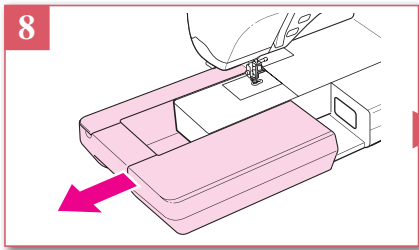
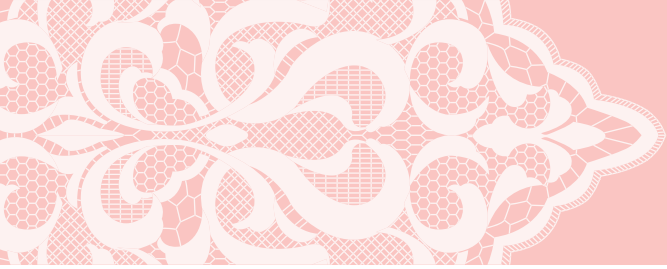

Selecting Stitch Patterns  
 Sélection des configurations de point  
 Selezione degli schemi punto

Wahl des Nähmusters  
 Kiezen van de steekpatronen  
 Selección de tipos de puntada

- ◁ LCD Flow Chart ..... ▷ LCD-Übersichtsdiagramm ..... ▷ Organigramme de l'écran à cristaux liquides
- ◁ LCD-stroomschema ..... ▷ Schema di flusso LCD ..... ▷ Diagrama de flujo del LCD

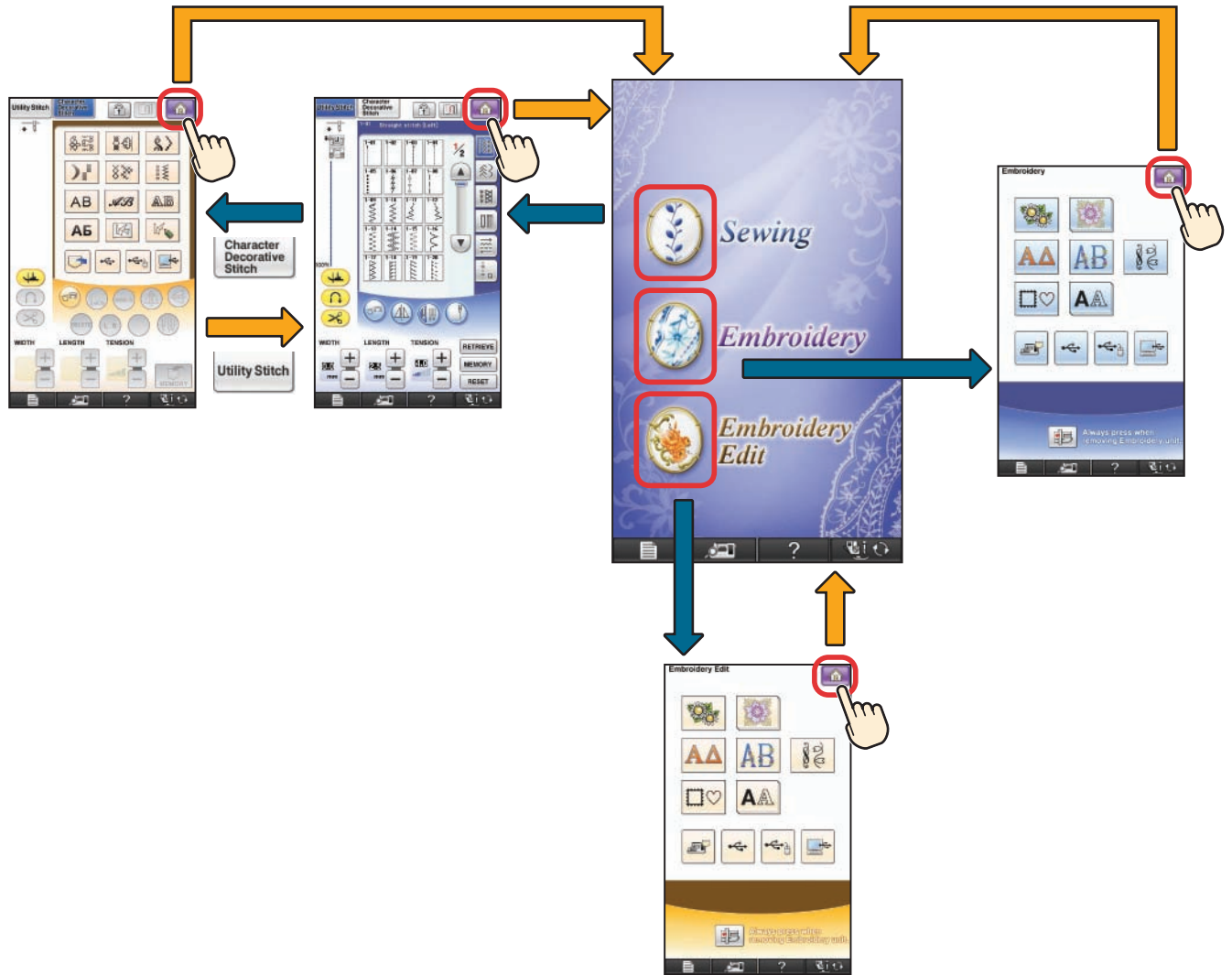



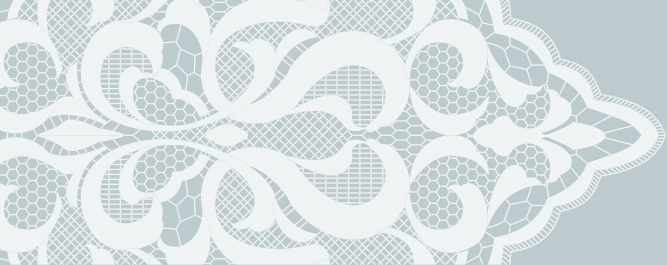



### Utility Stitches

When the machine is turned on, the home screen is displayed after the opening movie is played. Press  to display the utility stitch. Either "1-01 Straight stitch (Left)" or "1-03 Straight stitch (Middle)" is selected, depending on the setting selected in the setting screen.

### Naaisteken

Wanneer u de machine aanzet, verschijnt het startscherm nadat het openingsfilmpje is vertoond. Druk op  om de naaistek te tonen. Ofwel "1-01 Rechte steek (links)" of "1-03 Rechte steek (midden)" is geselecteerd, naar gelang de instelling die is geselecteerd in het instellingscherm.

### Nutzstiche

Bei Einschalten der Maschine erscheint nach Abspielen des Eröffnungsfilms der Startbildschirm. Drücken Sie  zur Anzeige der Nutzstiche. Je nach Einstellung im Einstellbildschirm ist "1-01 Geradstich (links)" oder "1-03 Geradstich (Mitte)" ausgewählt.

### Punti utili

Quando si accende la macchina, la schermata iniziale viene visualizzata dopo la riproduzione del film di apertura. Premere  per visualizzare il punto utile. Viene selezionato "1-01 Punto diritto (sinistra)" o "1-03 Punto diritto (centrale)", a seconda dell'impostazione selezionata nella schermata delle impostazioni.

### Points utiles

Lorsque la machine est mise sous tension, l'écran d'accueil s'affiche après la lecture de la vidéo de démarrage. Appuyez sur  pour afficher le point de couture courant. « 1-01 point droit (gauche) » ou « 1-03 point droit (milieu) » est sélectionné, en fonction du réglage choisi sur l'écran de réglages.

### Puntadas utiles

Cuando encienda la máquina y, una vez visualizada la película de presentación, aparecerá la pantalla principal. Pulse  para ver la costura de utilidad. Se seleccionará la "Puntada recta 1-01 (izquierda)" o la "Puntada recta 1-03 (medio)", según el ajuste seleccionado en la pantalla de ajustes.

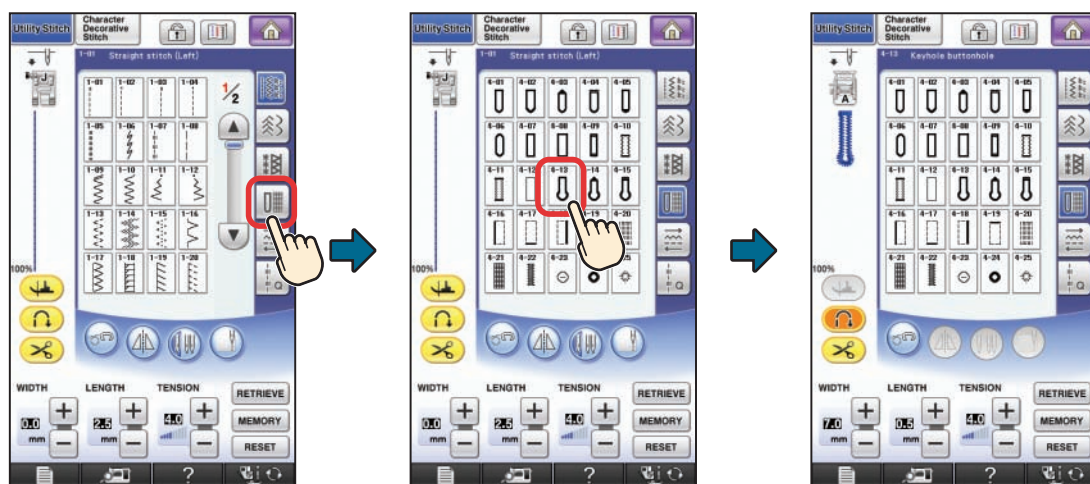

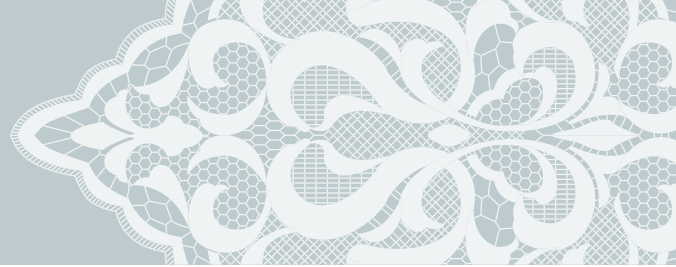

Character/Decorative Stitches

Buchstaben/Dekorative Stichmuster

Caractères/points décoratifs

Letter/decoratieve steken

Punti per caratteri/decorazioni

Puntadas de letras/decorativas

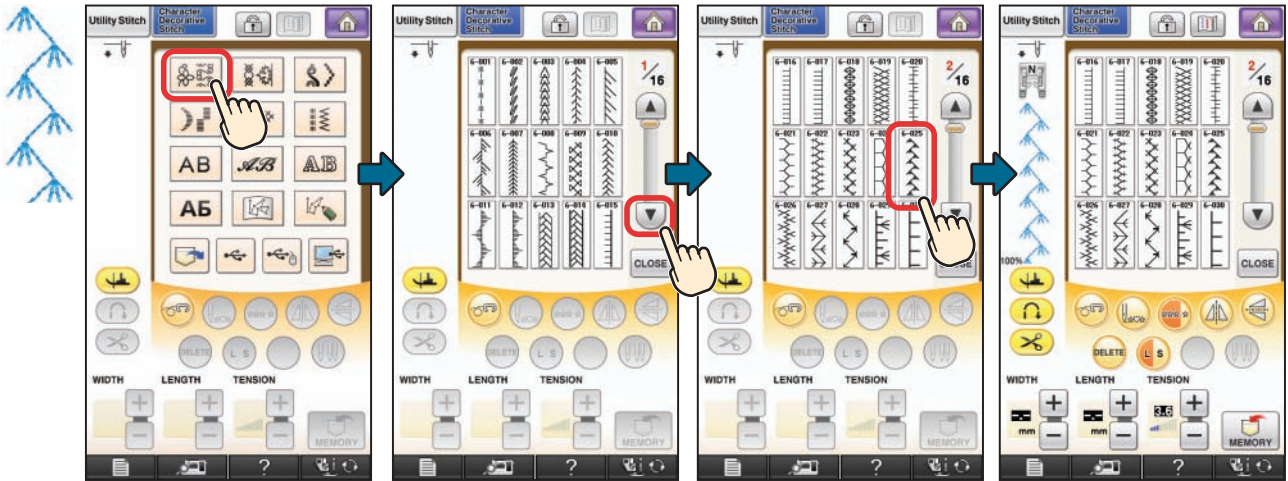

Embroidery Patterns

Stickmuster

Motifs de broderie

Borduurpatronen

Schemi di ricamo

Patrones de bordado

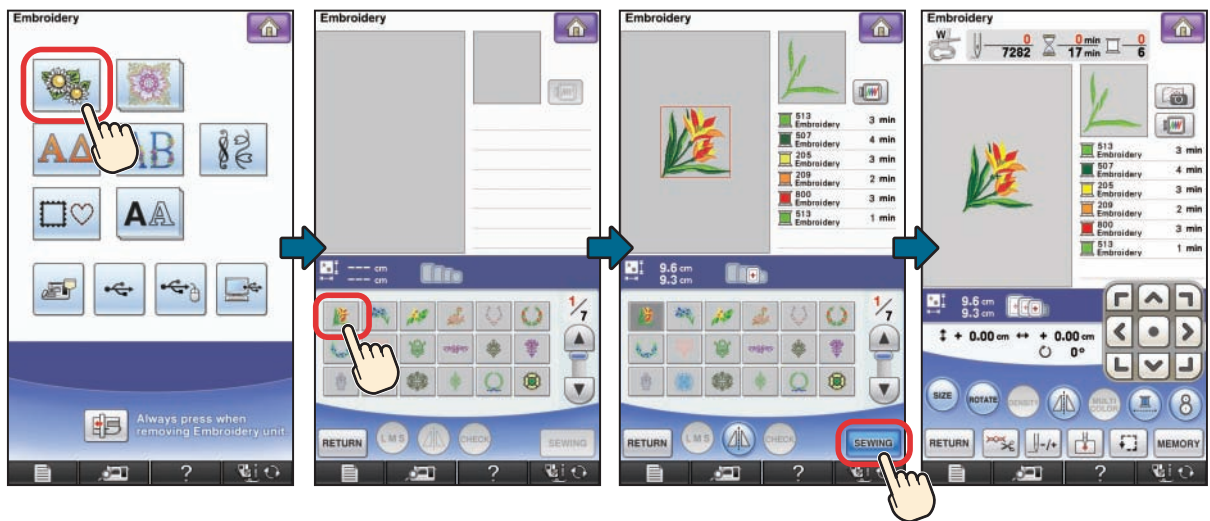



Embroidery Edit Patterns  
 Borduurbewerkingspatronen

Editieren von Stickmustern  
 Schemi di modifica ricamo

Motifs de modification de broderie  
 Patrones de edición de bordado

**FLOWER**



The sequence of screenshots illustrates the following steps:

- Pattern Selection:** The user selects a flower pattern from a grid of options.
- Character Entry:** The user enters the characters 'A', 'B', and 'G' into the pattern's designated fields.
- Character Confirmation:** The user confirms the character entry by pressing the 'F' key on the keyboard.
- Pattern Preview:** The machine displays the selected pattern with the characters 'A', 'B', and 'G' overlaid on it.
- Pattern Confirmation:** The user presses the 'SET' button to confirm the pattern.
- Pattern Editing:** The user adjusts the pattern's size and position using the touch screen controls.
- Pattern Sewing:** The user presses the 'SEWING' button to start the embroidery process.



Others

Sonstiges

Autres

Overige

Altro

Otros

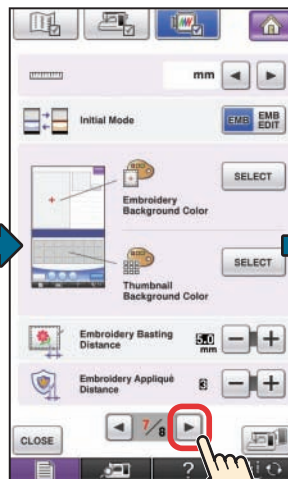
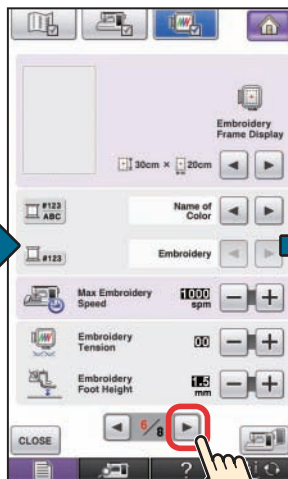
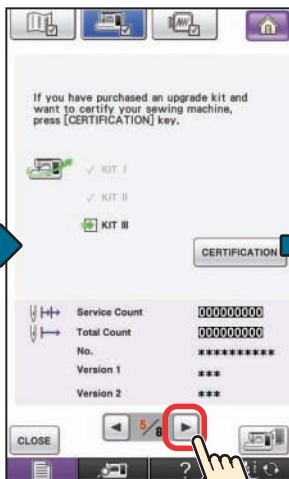
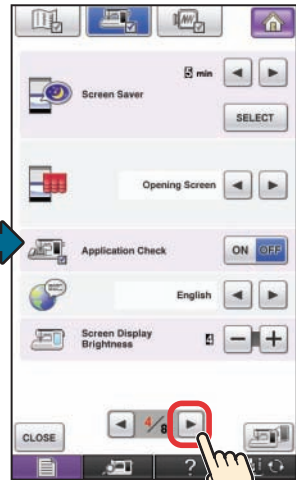
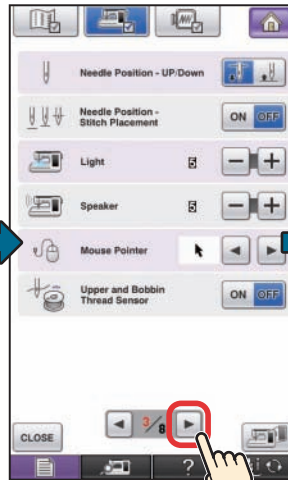
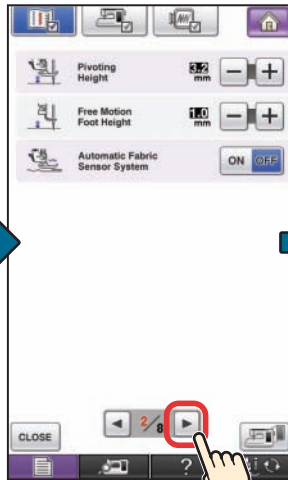
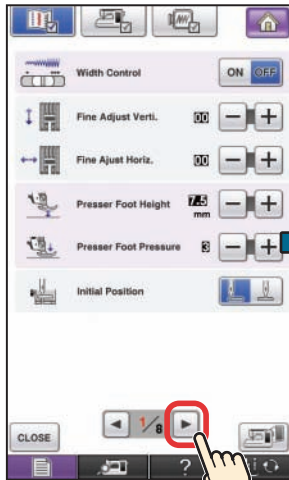

# Summary of Stitch Patterns

## Sommaire des motifs de point

## Sommario degli schemi punto

# Nähmuster-Übersicht

## Overzicht van de steekpatronen

## Resumen de tipos de puntada

### Utility Stitches

### Naaisteken

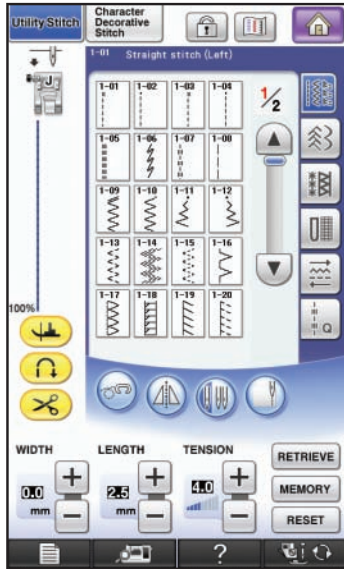

### Nutzstiche

### Punti utili

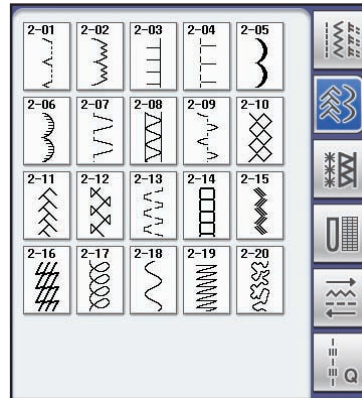
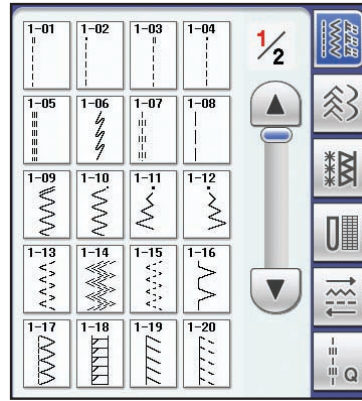

### Points utilitaires

### Puntadas utiles

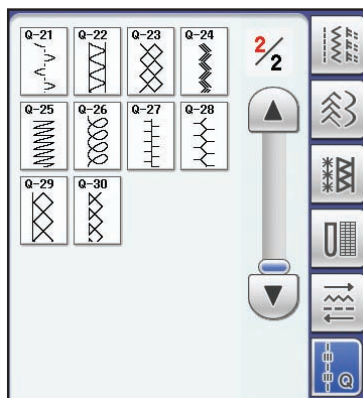
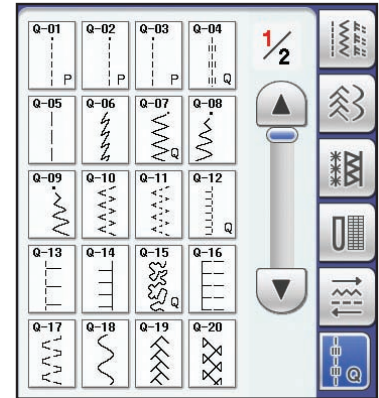
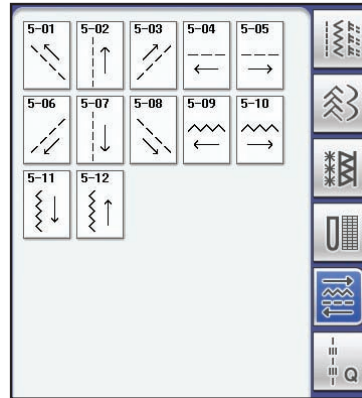
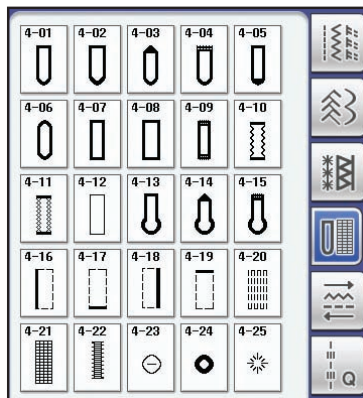
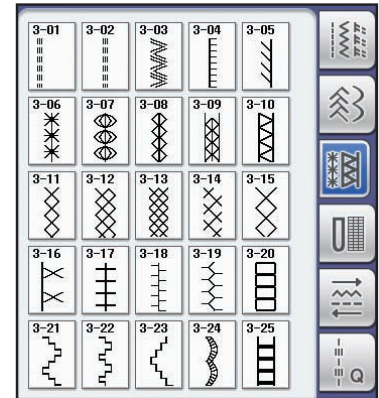
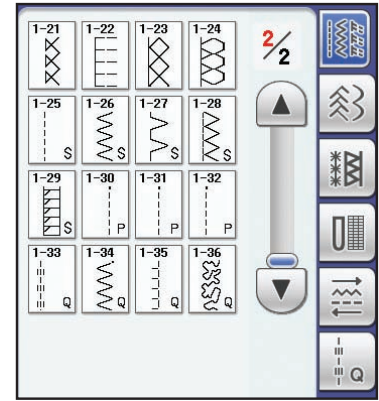



Character/Decorative Stitches

Buchstaben/Dekorative Stichmuster

Caractères/points décoratifs

Letter/decoratieve steken

Punti per caratteri/decorazioni

Puntadas de letras/decorativas

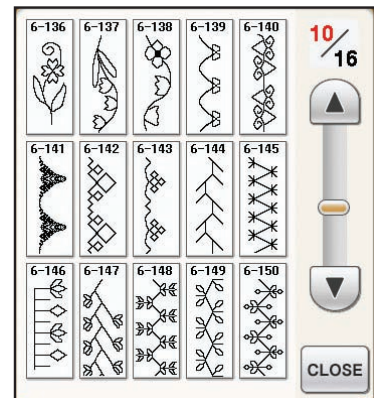
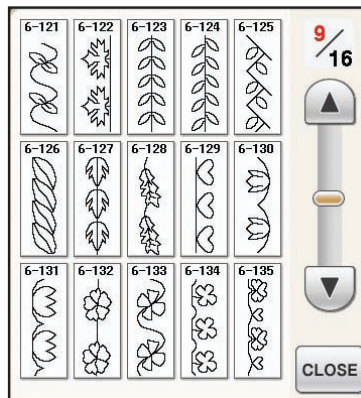
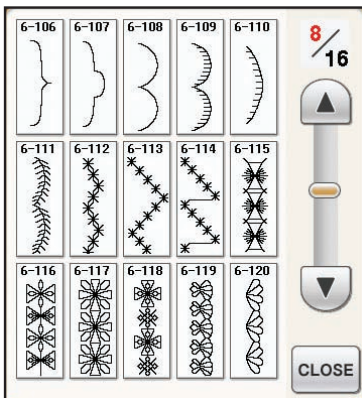
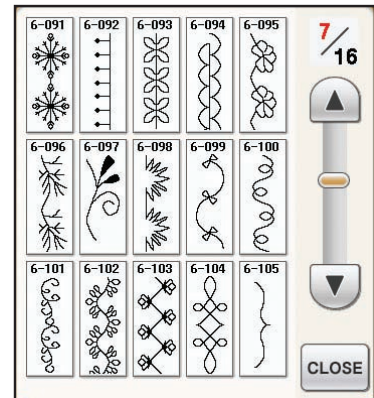
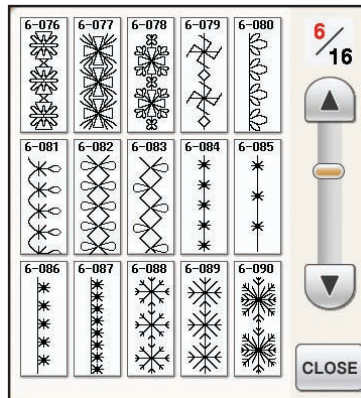
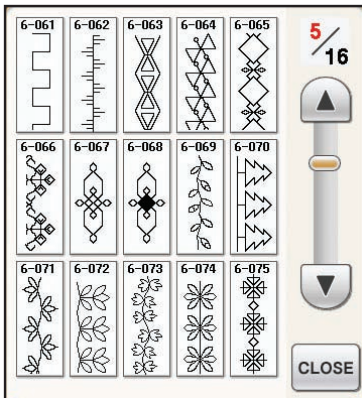
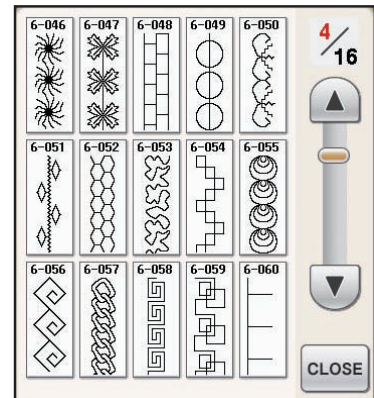
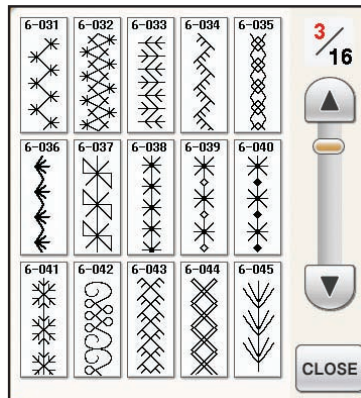
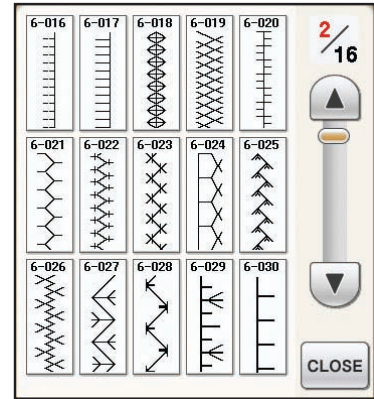
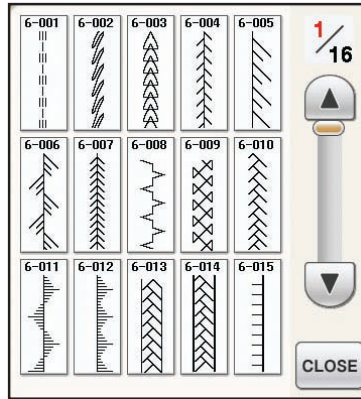
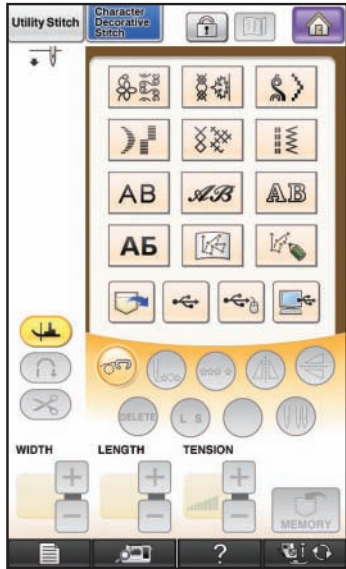



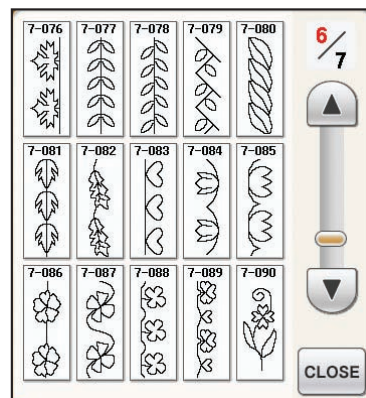
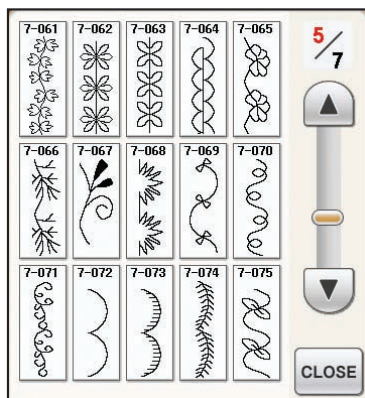
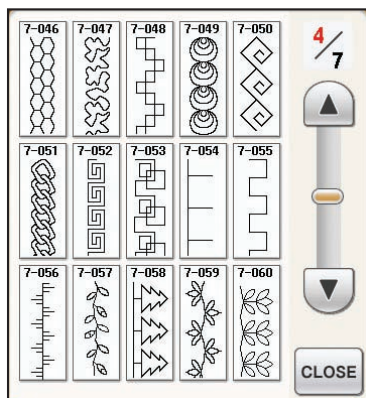
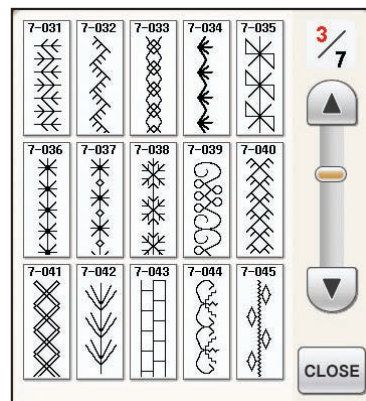
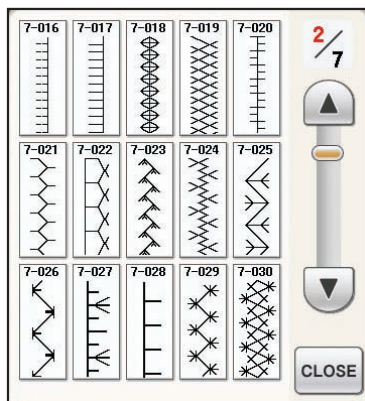
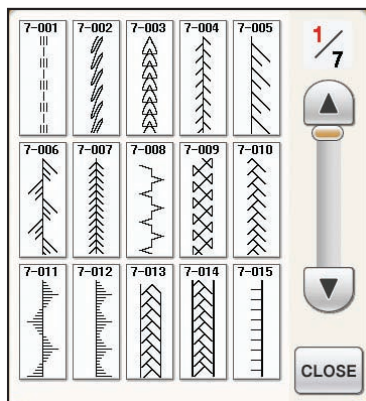
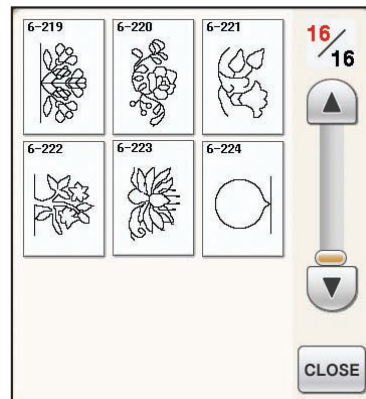
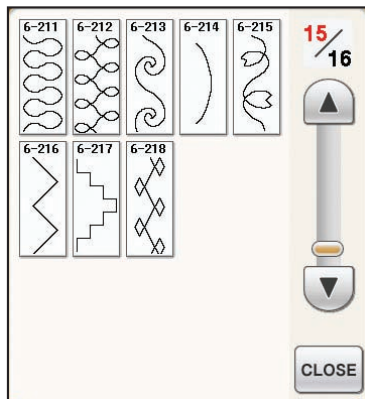
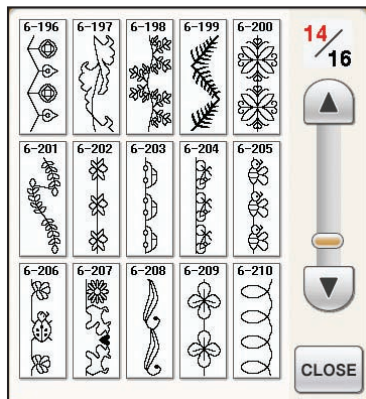
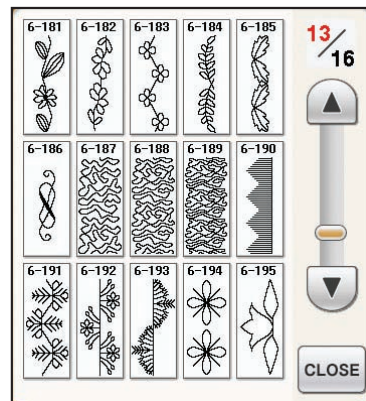
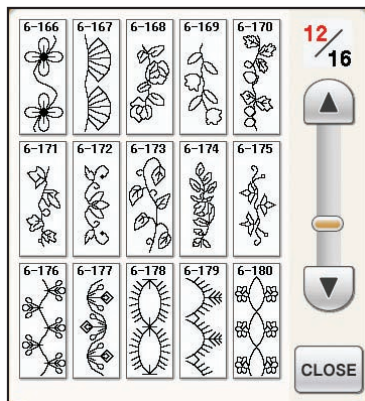
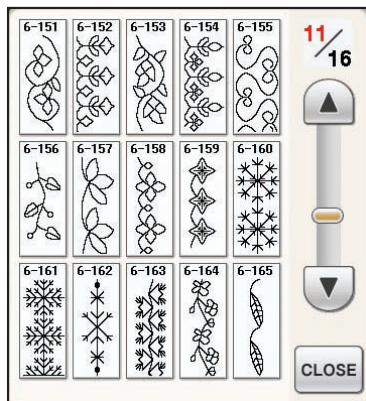

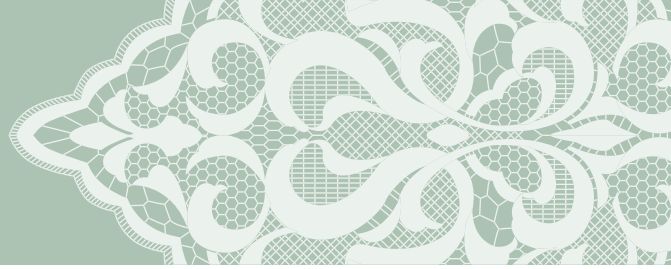

7-091	7-092	7-093	7-094	7 / 7
				▲
				▼
				CLOSE



8-01	8-02	8-03	8-04	8-05	1 / 5
8-06	8-07	8-08	8-09	8-10	▲
8-11	8-12	8-13	8-14	8-15	▼
					CLOSE

8-16	8-17	8-18	8-19	8-20	2 / 5
8-21	8-22	8-23	8-24	8-25	▲
8-26	8-27	8-28	8-29	8-30	▼
					CLOSE

8-31	8-32	8-33	8-34	8-35	3 / 5
8-36	8-37	8-38	8-39	8-40	▲
8-41	8-42	8-43	8-44	8-45	▼
					CLOSE

8-46	8-47	8-48	8-49	8-50	4 / 5
8-51	8-52	8-53	8-54	8-55	▲
8-56	8-57	8-58	8-59	8-60	▼
					CLOSE

8-61	8-62	8-63	8-64	8-65	5 / 5
8-66	8-67	8-68	8-69	8-70	▲
8-71	8-72				▼
					CLOSE



9-01	9-02	9-03	9-04	9-05	9-06	
9-07	9-08	9-09	9-10	9-11	9-12	
9-13	9-14	9-15	9-16	9-17	9-18	
9-19	9-20					
↙	↘					
						CLOSE



10-01	10-02	10-03	10-04	10-05	10-06	
10-07	10-08	10-09	10-10	10-11	10-12	
10-13	10-14	10-15	10-16	10-17		
						CLOSE



1 / 3

11-01	11-02	11-03	11-04	11-05
11-06	11-07	11-08	11-09	11-10
11-11	11-12	11-13	11-14	11-15
11-16	11-17	11-18	11-19	11-20
11-21	11-22	11-23	11-24	11-25

CLOSE

2 / 3

11-26	11-27	11-28	11-29	11-30
11-31	11-32	11-33	11-34	11-35
11-36	11-37	11-38	11-39	11-40
11-41	11-42	11-43	11-44	11-45
11-46	11-47	11-48	11-49	11-50

CLOSE

3 / 3

11-51	11-52	11-53	11-54	11-55
11-56	11-57	11-58	11-59	11-60
11-61	11-62	11-63		

CLOSE



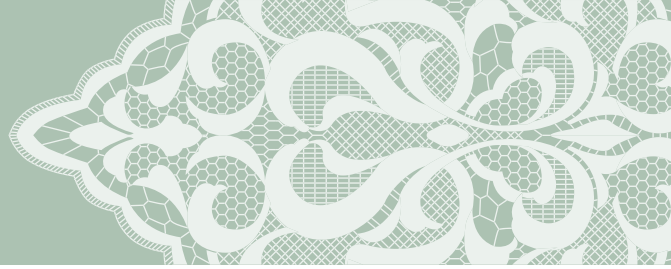

AB

A	B	C	D	E	ABC
F	G	H	I	J	abc
K	L	M	N	O	0-9..
P	Q	R	S	T	&?! ÄÄä
U	V	W	X	Y	ÖÖö
Z	'	_	CLOSE		

α	β	γ	δ	ε	ABC
f	g	h	i	j	abc
k	l	m	n	o	0-9..
p	q	r	s	t	&?! ÄÄä
u	v	w	x	y	ÖÖö
z	'	_	CLOSE		

0	1	2	3	4	ABC
5	6	7	8	9	abc
#	%	\$	£	€	0-9..
¥	-	+	X	÷	&?! ÄÄä
=	*	.	,	'	ÖÖö
_	CLOSE				

&	?	!	@	<	ABC
>	(	)	[	]	abc
/	\	~	:	;	0-9..
©	®	™	“	”	&?! ÄÄä
"	'	‘	’	_	ÖÖö
CLOSE					

Â	Ä	Å	à	á	ABC
â	ã	ä	å	æ	abc
œ	Ç	ç	È	É	0-9..
Ê	Ë	è	é	ê	&?! ÄÄä
ë	Ï	ì	í	ï	ÖÖö
Ñ	ñ	Í	í	_	CLOSE

Ô	Ö	Ø	ò	ó	ABC
ô	ö	ø	û	ü	abc
ù	ú	û	ü	þ	0-9..
ƒ	B	i	İ	Ñ	&?! ÄÄä
Õ	õ	Œ	œ	ƣ	ÖÖö
t	z	'	_	CLOSE	

AB

<i>A</i>	<i>B</i>	<i>C</i>	<i>D</i>	<i>E</i>	ABC
<i>F</i>	<i>G</i>	<i>H</i>	<i>I</i>	<i>J</i>	abc
<i>K</i>	<i>L</i>	<i>M</i>	<i>N</i>	<i>O</i>	0-9..
<i>P</i>	<i>Q</i>	<i>R</i>	<i>S</i>	<i>T</i>	&?! ÄÄä
<i>U</i>	<i>V</i>	<i>W</i>	<i>X</i>	<i>Y</i>	ÖÖö
<i>Z</i>	'	_	CLOSE		

<i>α</i>	<i>β</i>	<i>γ</i>	<i>δ</i>	<i>ε</i>	ABC
<i>f</i>	<i>g</i>	<i>h</i>	<i>i</i>	<i>j</i>	abc
<i>k</i>	<i>l</i>	<i>m</i>	<i>n</i>	<i>o</i>	0-9..
<i>p</i>	<i>q</i>	<i>r</i>	<i>s</i>	<i>t</i>	&?! ÄÄä
<i>u</i>	<i>v</i>	<i>w</i>	<i>x</i>	<i>y</i>	ÖÖö
<i>z</i>	'	_	CLOSE		

<i>0</i>	<i>1</i>	<i>2</i>	<i>3</i>	<i>4</i>	ABC
<i>5</i>	<i>6</i>	<i>7</i>	<i>8</i>	<i>9</i>	abc
<i>#</i>	<i>%</i>	<i>\$</i>	<i>£</i>	<i>€</i>	0-9..
<i>¥</i>	<i>-</i>	<i>+</i>	<i>X</i>	<i>÷</i>	&?! ÄÄä
<i>=</i>	<i>*</i>	<i>.</i>	<i>,</i>	<i>'</i>	ÖÖö
<i>_</i>	CLOSE				

&	?	!	@	<	ABC
>	(	)	[	]	abc
/	\	~	:	;	0-9..
©	®	™	“	”	&?! ÄÄä
"	'	‘	’	_	ÖÖö
CLOSE					

<i>Â</i>	<i>Ä</i>	<i>Å</i>	<i>à</i>	<i>á</i>	ABC
<i>â</i>	<i>ã</i>	<i>ä</i>	<i>å</i>	<i>æ</i>	abc
<i>œ</i>	<i>Ç</i>	<i>ç</i>	<i>È</i>	<i>É</i>	0-9..
<i>Ê</i>	<i>Ë</i>	<i>è</i>	<i>é</i>	<i>ê</i>	&?! ÄÄä
<i>ë</i>	<i>Ï</i>	<i>ì</i>	<i>í</i>	<i>ï</i>	ÖÖö
<i>Ñ</i>	<i>ñ</i>	<i>Í</i>	<i>í</i>	_	CLOSE

<i>Ô</i>	<i>Ö</i>	<i>Ø</i>	<i>ò</i>	<i>ó</i>	ABC
<i>ô</i>	<i>ö</i>	<i>ø</i>	<i>û</i>	<i>ü</i>	abc
<i>ù</i>	<i>ú</i>	<i>û</i>	<i>ü</i>	<i>þ</i>	0-9..
<i>ƒ</i>	<i>B</i>	<i>i</i>	<i>İ</i>	<i>Ñ</i>	&?! ÄÄä
<i>Õ</i>	<i>õ</i>	<i>Œ</i>	<i>œ</i>	<i>ƣ</i>	ÖÖö
<i>t</i>	<i>z</i>	<i>'</i>	<i>_</i>	CLOSE	



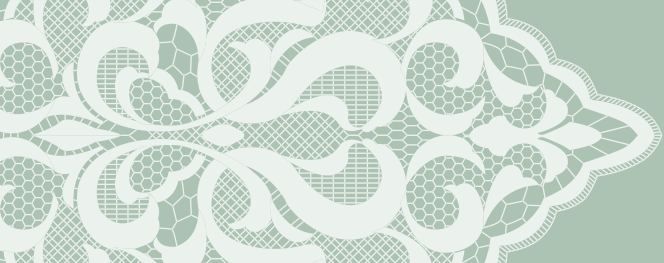

**AB**

A	B	C	D	E	ABC
F	G	H	I	J	abc
K	L	M	N	O	0-9..
P	Q	R	S	T	&?!
U	V	W	X	Y	ÄÄä
Z	'	_			ÖÖö
CLOSE					

a	b	c	d	e	ABC
f	g	h	i	j	abc
k	l	m	n	o	0-9..
p	q	r	s	t	&?!
u	v	w	x	y	ÄÄä
z	'	_			ÖÖö
CLOSE					

0	1	2	3	4	ABC
5	6	7	8	9	abc
#	%	\$	€	€	0-9..
¥	□	+	×	÷	&?!
≡	*	°	,	'	ÄÄä
_					ÖÖö
CLOSE					

&	?	!	⊙	<	ABC
>	(	)	[	]	abc
/	\	~	:	;	0-9..
⊙	⊗	™	♠	♣	&?!
"	'	°	'	_	ÄÄä
					ÖÖö
CLOSE					

Â	Ä	Å	à	á	ABC
â	ä	å	ä	æ	abc
œ	ç	ç	è	é	0-9..
ê	ë	è	é	ê	&?!
ë	ï	ì	í	ï	ÄÄä
ñ	ñ	í	í	_	ÖÖö
CLOSE					

Ô	Ö	Ø	ò	ó	ABC
ô	ö	ø	û	ü	abc
ù	ú	û	ü	ü	0-9..
ü	ß	ï	í	ñ	&?!
ó	ó	œ	œ	ř	ÄÄä
t'	z'	'	_		ÖÖö
CLOSE					

**AB**

А	Б	В	Г	Д	АБВ
Е	Ё	Ж	З	И	чшщ
Й	К	Л	М	Н	абв
О	П	Р	С	Т	чшщ
У	Ф	Х	Ц	_	0-9..
CLOSE					

Ч	Ш	Щ	Ь	Ы	АБВ
ь	э	ю	я	Г	чшщ
е	і	ї	ў	ћ	абв
ћ	Ј	Јь	Њ	Ц	чшщ
Ѓ	Ѕ	Њ	_		0-9..
CLOSE					

а	б	в	г	д	АБВ
е	ё	ж	з	и	чшщ
й	к	л	м	н	абв
о	п	р	с	т	чшщ
у	ф	х	ц	_	0-9..
CLOSE					

ч	ш	щ	ь	ы	АБВ
ь	э	ю	я	Г	чшщ
е	і	ї	ў	ћ	абв
ћ	Ј	Јь	Њ	Ц	чшщ
Ѓ	Ѕ	Њ	_		0-9..
CLOSE					

0	1	2	3	4	АБВ
5	6	7	8	9	чшщ
-	.	,	&	?	абв
!	(	)	/	'	чшщ
_					0-9..
CLOSE					



Embroidery Patterns

Borduurpatronen

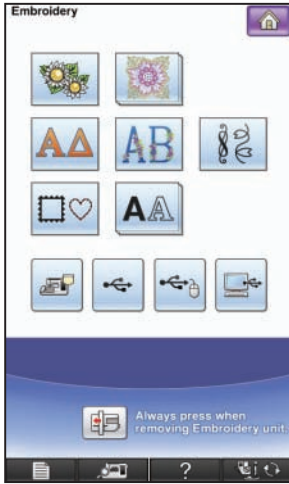

Stickmuster

Schemi di ricamo

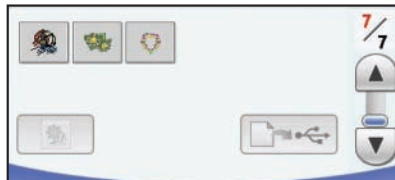

Motifs de broderie

Patrones de bordado

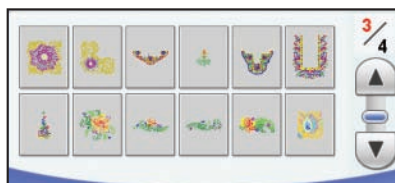
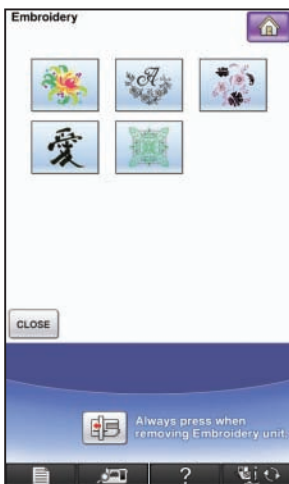
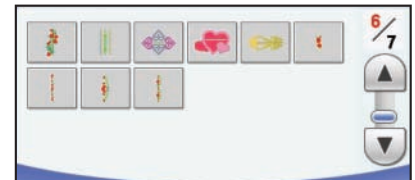
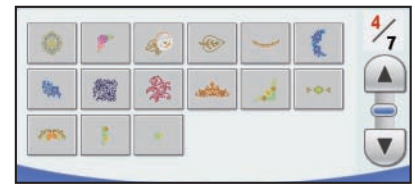

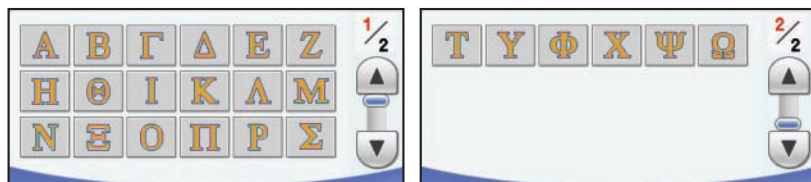
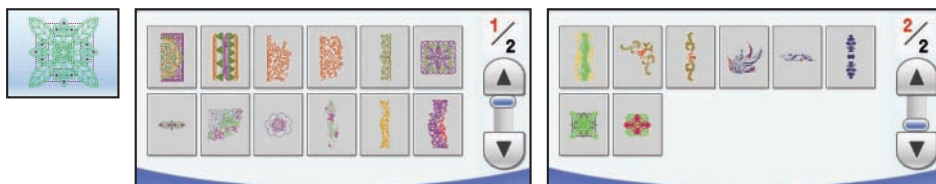
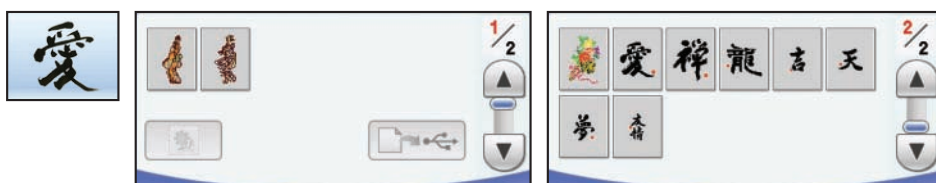
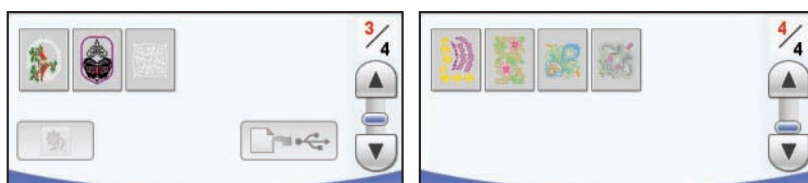
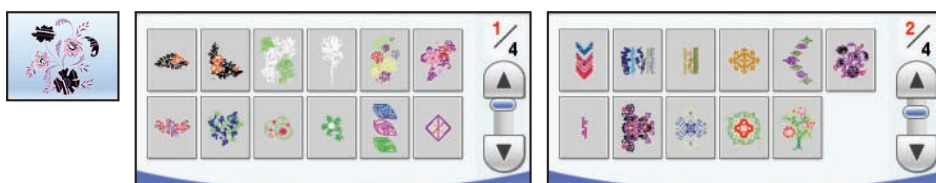
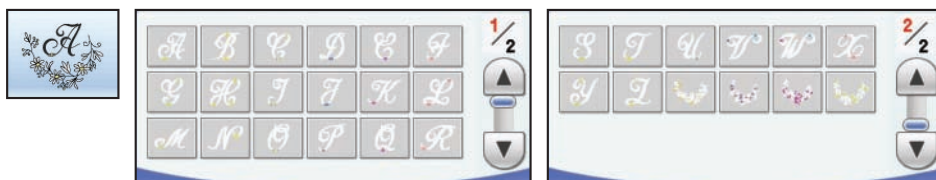



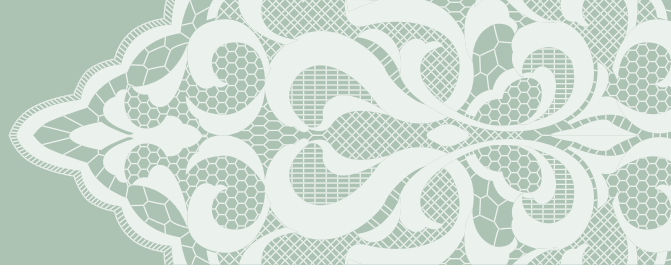



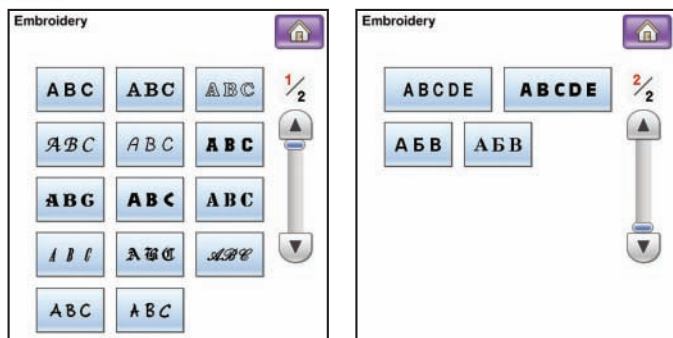
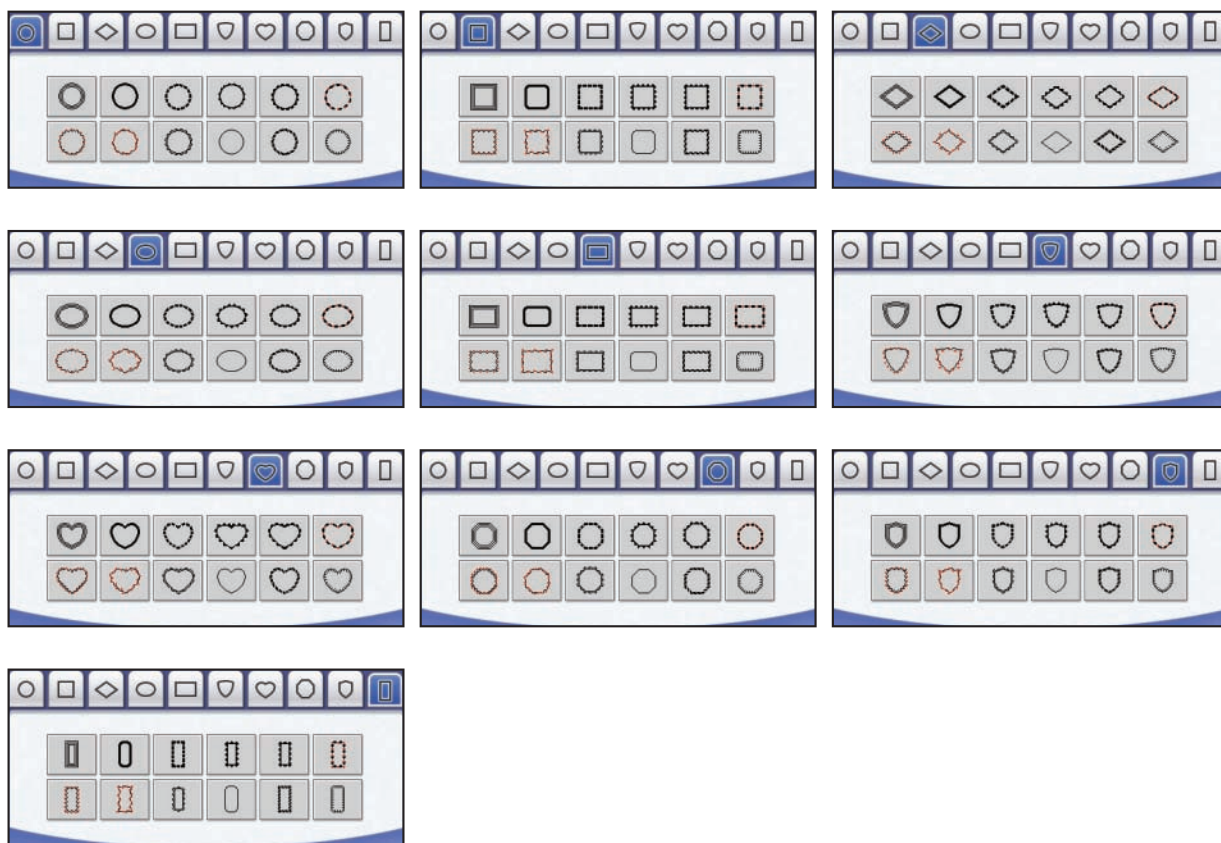



ABC

ABC	abc	0-9..	&?!	ÄÄä	ÖÖö	DELETE			
A	B	C	D	E	F	G	H	I	J
K	L	M	N	O	P	Q	R	S	T
U	V	W	X	Y	Z	'	_		

ABC	abc	0-9..	&?!	ÄÄä	ÖÖö	DELETE			
a	b	c	d	e	f	g	h	i	j
k	l	m	n	o	p	q	r	s	t
u	v	w	x	y	z	'	_		

ABC	abc	0-9..	&?!	ÄÄä	ÖÖö	DELETE			
0	1	2	3	4	5	6	7	8	9
#	%	\$	£	€	¥	-	+	x	÷
=	*	.	,	'	_				

ABC	abc	0-9..	&?!	ÄÄä	ÖÖö	DELETE			
&	?	!	@	<	>	(	)	[	]
/	\	~	:	:	©	®	™	“	”
”	'	'	'	'	_				

ABC	abc	0-9..	&?!	ÄÄä	ÖÖö	DELETE			
Â	Ä	Å	à	á	â	ã	ä	å	Æ
æ	Ç	ç	È	É	Ê	Ë	è	é	ê
ë	Ï	ì	ï	Ð	Ñ	ñ	Í	í	_

ABC	abc	0-9..	&?!	ÄÄä	ÖÖö	DELETE			
Ô	Ö	Ø	ò	ó	ô	ö	ø	Û	Ü
ù	ú	û	ü	Þ	þ	ß	ì	ï	Ñ
Õ	õ	Œ	œ	í	í	í	'	í	_

ABC

ABC	abc	0-9..	&?!	ÄÄä	ÖÖö	DELETE			
A	B	C	D	E	F	G	H	I	J
K	L	M	N	O	P	Q	R	S	T
U	V	W	X	Y	Z	'	_		

ABC	abc	0-9..	&?!	ÄÄä	ÖÖö	DELETE			
a	b	c	d	e	f	g	h	i	j
k	l	m	n	o	p	q	r	s	t
u	v	w	x	y	z	'	_		

ABC	abc	0-9..	&?!	ÄÄä	ÖÖö	DELETE			
0	1	2	3	4	5	6	7	8	9
#	%	\$	£	€	¥	-	+	x	÷
=	*	.	,	'	_				

ABC	abc	0-9..	&?!	ÄÄä	ÖÖö	DELETE			
&	?	!	@	<	>	(	)	[	]
/	\	~	:	:	©	®	™	“	”
”	'	'	'	'	_				

ABC	abc	0-9..	&?!	ÄÄä	ÖÖö	DELETE			
Â	Ä	Å	à	á	â	ã	ä	å	Æ
æ	Ç	ç	È	É	Ê	Ë	è	é	ê
ë	Ï	ì	ï	Ð	Ñ	ñ	Í	í	_

ABC	abc	0-9..	&?!	ÄÄä	ÖÖö	DELETE			
Ô	Ö	Ø	ò	ó	ô	ö	ø	Û	Ü
ù	ú	û	ü	Þ	þ	ß	ì	ï	Ñ
Õ	õ	Œ	œ	í	í	í	'	í	_

ABC

ABC	abc	0-9..	&?!	ÄÄä	ÖÖö	DELETE			
A	B	C	D	E	F	G	H	I	J
K	L	M	N	O	P	Q	R	S	T
U	V	W	X	Y	Z	'	_		

ABC	abc	0-9..	&?!	ÄÄä	ÖÖö	DELETE			
a	b	c	d	e	f	g	h	i	j
k	l	m	n	o	p	q	r	s	t
u	v	w	x	y	z	'	_		

ABC	abc	0-9..	&?!	ÄÄä	ÖÖö	DELETE			
0	1	2	3	4	5	6	7	8	9
#	%	\$	£	€	¥	-	+	x	÷
=	*	.	,	'	_				

ABC	abc	0-9..	&?!	ÄÄä	ÖÖö	DELETE			
&	?	!	@	<	>	(	)	[	]
/	\	~	:	:	©	®	™	“	”
”	'	'	'	'	_				

ABC	abc	0-9..	&?!	ÄÄä	ÖÖö	DELETE			
Â	Ä	Å	à	á	â	ã	ä	å	Æ
æ	Ç	ç	È	É	Ê	Ë	è	é	ê
ë	Ï	ì	ï	Ð	Ñ	ñ	Í	í	_

ABC	abc	0-9..	&?!	ÄÄä	ÖÖö	DELETE			
Ô	Ö	Ø	ò	ó	ô	ö	ø	Û	Ü
ù	ú	û	ü	Þ	þ	ß	ì	ï	Ñ
Õ	õ	Œ	œ	í	í	í	'	í	_





ABC

ABC	abc	0-9..	&?!	ÄÄä	ÖÖö	DELETE			
A	B	C	D	E	F	G	H	I	J
K	L	M	N	O	P	Q	R	S	T
U	V	W	X	Y	Z	'	_		

ABC	abc	0-9..	&?!	ÄÄä	ÖÖö	DELETE			
a	b	c	d	e	f	g	h	i	j
k	l	m	n	o	p	q	r	s	t
u	v	w	x	y	z	'	_		

ABC	abc	0-9..	&?!	ÄÄä	ÖÖö	DELETE			
0	1	2	3	4	5	6	7	8	9
#	%	\$	£	€	¥	-	+	x	÷
=	*	.	,	'	_				

ABC	abc	0-9..	&?!	ÄÄä	ÖÖö	DELETE			
&	?	!	@	<	>	(	)	[	]
/	\	~	:	:	©	®	™	"	"
"	'	'	'	_					

ABC	abc	0-9..	&?!	ÄÄä	ÖÖö	DELETE			
À	Á	Â	à	á	â	ã	ä	å	Æ
æ	Ç	ç	È	É	Ê	Ë	è	é	ê
ë	Ï	ì	í	Î	Ï	Ñ	ñ	'	_

ABC	abc	0-9..	&?!	ÄÄä	ÖÖö	DELETE			
Ô	Õ	Ø	ò	ó	ô	õ	ø	Ù	Ú
ù	ú	û	ü	Ɔ	Ɔ	Ɔ	Ɔ	Ɔ	Ɔ
Œ	œ	ƒ	ƒ	ƒ	'	_			

ABC

ABC	abc	0-9..	&?!	ÄÄä	ÖÖö	DELETE			
A	B	C	D	E	F	G	H	I	J
K	L	M	N	O	P	Q	R	S	T
U	V	W	X	Y	Z	'	_		

ABC	abc	0-9..	&?!	ÄÄä	ÖÖö	DELETE			
a	b	c	d	e	f	g	h	i	j
k	l	m	n	o	p	q	r	s	t
u	v	w	x	y	z	'	_		

ABC	abc	0-9..	&?!	ÄÄä	ÖÖö	DELETE			
0	1	2	3	4	5	6	7	8	9
#	%	\$	£	€	¥	-	+	x	÷
=	*	.	,	'	_				

ABC	abc	0-9..	&?!	ÄÄä	ÖÖö	DELETE			
&	?	!	@	<	>	(	)	[	]
/	\	~	:	:	©	®	™	"	"
"	'	'	'	_					

ABC	abc	0-9..	&?!	ÄÄä	ÖÖö	DELETE			
À	Á	Â	à	á	â	ã	ä	å	Æ
æ	Ç	ç	È	É	Ê	Ë	è	é	ê
ë	Ï	ì	í	Î	Ï	Ñ	ñ	'	_

ABC	abc	0-9..	&?!	ÄÄä	ÖÖö	DELETE			
Ô	Õ	Ø	ò	ó	ô	õ	ø	Ù	Ú
ù	ú	û	ü	Ɔ	Ɔ	Ɔ	Ɔ	Ɔ	Ɔ
Œ	œ	ƒ	ƒ	ƒ	'	_			

ABC

ABC	abc	0-9..	&?!	ÄÄä	ÖÖö	DELETE			
A	B	C	D	E	F	G	H	I	J
K	L	M	N	O	P	Q	R	S	T
U	V	W	X	Y	Z	'	_		

ABC	abc	0-9..	&?!	ÄÄä	ÖÖö	DELETE			
a	b	c	d	e	f	g	h	i	j
k	l	m	n	o	p	q	r	s	t
u	v	w	x	y	z	'	_		

ABC	abc	0-9..	&?!	ÄÄä	ÖÖö	DELETE			
0	1	2	3	4	5	6	7	8	9
#	%	\$	£	€	¥	-	+	x	÷
=	*	.	,	'	_				

ABC	abc	0-9..	&?!	ÄÄä	ÖÖö	DELETE			
Œ	?	!	@	<	>	(	)	[	]
/	\	~	:	:	©	®	™	"	"
"	'	'	'	_					

ABC	abc	0-9..	&?!	ÄÄä	ÖÖö	DELETE			
À	Á	Â	à	á	â	ã	ä	å	Æ
æ	Ç	ç	È	É	Ê	Ë	è	é	ê
ë	Ï	ì	í	Î	Ï	Ñ	ñ	'	_

ABC	abc	0-9..	&?!	ÄÄä	ÖÖö	DELETE			
Ô	Õ	Ø	ò	ó	ô	õ	ø	Ù	Ú
ù	ú	û	ü	Ɔ	Ɔ	Ɔ	Ɔ	Ɔ	Ɔ
Œ	œ	ƒ	ƒ	ƒ	'	_			

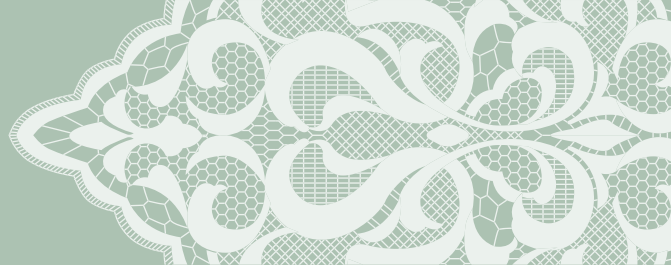

**ABC**

ABC	abc	0-9..	&?!	ÄÄä	ÖÖö	DELETE			
A	B	C	D	E	F	G	H	I	J
K	L	M	N	O	P	Q	R	S	T
U	V	W	X	Y	Z	'	_		

ABC	abc	0-9..	&?!	ÄÄä	ÖÖö	DELETE			
a	b	c	d	e	f	g	h	i	j
k	l	m	n	o	p	q	r	s	t
u	v	w	x	y	z	'	_		

ABC	abc	0-9..	&?!	ÄÄä	ÖÖö	DELETE			
0	1	2	3	4	5	6	7	8	9
#	%	\$	€	¥	-	+	x	÷	
=	*	.	,	'	_				

ABC	abc	0-9..	&?!	ÄÄä	ÖÖö	DELETE			
&	?	!	@	<	>	(	)		
/	\	~	:	:	©	®	™	“	”
“	”	'	'	'	'	'	'	'	'

ABC	abc	0-9..	&?!	ÄÄä	ÖÖö	DELETE			
À	Á	Â	Ã	Ä	Å	Æ	Ç	È	É
Ê	Ë	Ì	Í	Î	Ï	Ð	Ñ	Ò	Ó
Ô	Õ	Ö	×	Ø	Ù	Ú	Û	Ü	Ý

ABC	abc	0-9..	&?!	ÄÄä	ÖÖö	DELETE			
Ô	Õ	Ø	ò	ó	ô	ö	ø	ù	ü
ù	ú	û	ü	þ	ƒ	ı	ı	ı	ı
Ö	ö	œ	œ	ř	ř	ž	ž	'	'

**ABC**

ABC	abc	0-9..	&?!	ÄÄä	ÖÖö	DELETE			
A	B	C	D	E	F	G	H	I	J
K	L	M	N	O	P	Q	R	S	T
U	V	W	X	Y	Z	'	_		

ABC	abc	0-9..	&?!	ÄÄä	ÖÖö	DELETE			
a	b	c	d	e	f	g	h	i	j
k	l	m	n	o	p	q	r	s	t
u	v	w	x	y	z	'	_		

ABC	abc	0-9..	&?!	ÄÄä	ÖÖö	DELETE			
0	1	2	3	4	5	6	7	8	9
#	%	\$	€	¥	-	+	x	÷	
=	*	.	,	'	_				

ABC	abc	0-9..	&?!	ÄÄä	ÖÖö	DELETE			
&	?	!	@	<	>	(	)		
/	\	~	:	:	©	®	™	“	”
“	”	'	'	'	'	'	'	'	'

ABC	abc	0-9..	&?!	ÄÄä	ÖÖö	DELETE			
À	Á	Â	Ã	Ä	Å	Æ	Ç	È	É
Ê	Ë	Ì	Í	Î	Ï	Ð	Ñ	Ò	Ó
Ô	Õ	Ö	×	Ø	Ù	Ú	Û	Ü	Ý

ABC	abc	0-9..	&?!	ÄÄä	ÖÖö	DELETE			
Ô	Õ	Ø	ò	ó	ô	ö	ø	ù	ü
ù	ú	û	ü	þ	ƒ	ı	ı	ı	ı
Ö	ö	œ	œ	ř	ř	ž	ž	'	'

**ABC**

ABC	abc	0-9..	&?!	ÄÄä	ÖÖö	DELETE			
A	B	C	D	E	F	G	H	I	J
K	L	M	N	O	P	Q	R	S	T
U	V	W	X	Y	Z	'	_		

ABC	abc	0-9..	&?!	ÄÄä	ÖÖö	DELETE			
a	b	c	d	e	f	g	h	i	j
k	l	m	n	o	p	q	r	s	t
u	v	w	x	y	z	'	_		

ABC	abc	0-9..	&?!	ÄÄä	ÖÖö	DELETE			
0	1	2	3	4	5	6	7	8	9
#	%	\$	€	¥	-	+	x	÷	
=	*	.	,	'	_				

ABC	abc	0-9..	&?!	ÄÄä	ÖÖö	DELETE			
&	?	!	@	<	>	(	)		
/	\	~	:	:	©	®	™	“	”
“	”	'	'	'	'	'	'	'	'

ABC	abc	0-9..	&?!	ÄÄä	ÖÖö	DELETE			
À	Á	Â	Ã	Ä	Å	Æ	Ç	È	É
Ê	Ë	Ì	Í	Î	Ï	Ð	Ñ	Ò	Ó
Ô	Õ	Ö	×	Ø	Ù	Ú	Û	Ü	Ý

ABC	abc	0-9..	&?!	ÄÄä	ÖÖö	DELETE			
Ô	Õ	Ø	ò	ó	ô	ö	ø	ù	ü
ù	ú	û	ü	þ	ƒ	ı	ı	ı	ı
Ö	ö	œ	œ	ř	ř	ž	ž	'	'





A B C

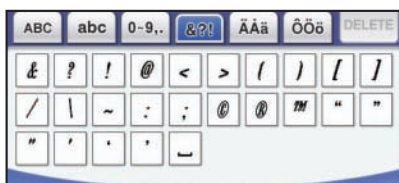

A B C

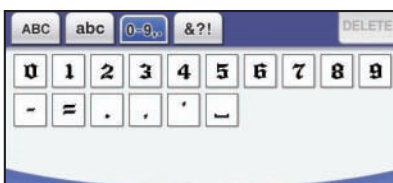

A B C



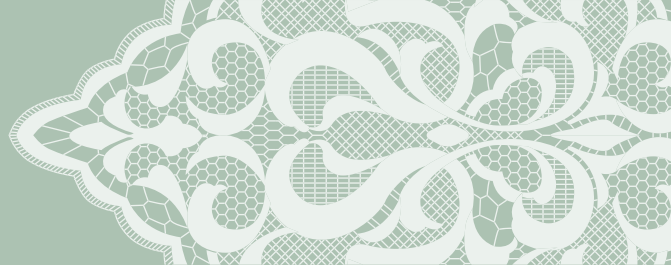

ABC



ABC



ABCDE

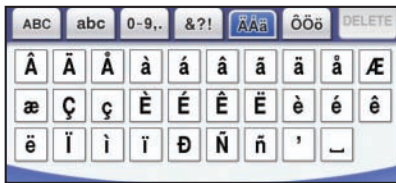





**ABCDE**

ABC abc 0-9.. &?! ÄÄä ÖÖö DELETE

A	B	C	D	E	F	G	H	I	J
K	L	M	N	O	P	Q	R	S	T
U	V	W	X	Y	Z	'	_		

ABC abc 0-9.. &?! ÄÄä ÖÖö DELETE

a	b	c	d	e	f	g	h	i	j
k	l	m	n	o	p	q	r	s	t
u	v	w	x	y	z	'	_		

ABC abc 0-9.. &?! ÄÄä ÖÖö DELETE

0	1	2	3	4	5	6	7	8	9
#	%	\$	£	€	¥	-	+	x	÷
=	*	.	,	'	_				

ABC abc 0-9.. &?! ÄÄä ÖÖö DELETE

&	?	!	@	<	>	(	)	[	]
/	\	~	:	;	©	®	™	"	"
"	'	'	'	_					

ABC abc 0-9.. &?! ÄÄä ÖÖö DELETE

À	Á	Â	Ã	Ä	Å	Æ	Ç	È	É
Ê	Ë	Ì	Í	Î	Ï	Ð	Ñ	Ò	Ó
Ô	Õ	Ö	×	Ù	Ú	Û	Ü	Ý	Þ

ABC abc 0-9.. &?! ÄÄä ÖÖö DELETE

Ô	Õ	Ö	Ø	ò	ó	ô	ö	ø	Ù
Ú	ú	Û	ü	Þ	þ	ß	ì	í	Ñ
õ	ö	œ	œ	í	í	í	'	'	_

**АБВ**

АБВ чшщ абв чшщ 0-9?! DELETE

А	Б	В	Г	Д	Е	Ё	Ж	З	И
Й	К	Л	М	Н	О	П	Р	С	Т
У	Ф	Х	Ц	_					

АБВ чшщ абв чшщ 0-9?! DELETE

Ч	Ш	Щ	Ъ	Ы	Ь	Э	Ю	Я	Г
Є	І	Ї	Ў	Ғ	Ҕ	Җ	Ҙ	Ҝ	Ҟ
Ҡ	Ң	Ҥ	Ҧ	ҧ	Ҩ	ҩ	Ҫ	ҫ	ҽ

АБВ чшщ абв чшщ 0-9?! DELETE

а	б	в	г	д	е	ё	ж	з	и
й	к	л	м	н	о	п	р	с	т
у	ф	х	ц	_					

АБВ чшщ абв чшщ 0-9?! DELETE

ч	ш	щ	ъ	ы	ь	э	ю	я	г
є	і	ї	ў	ғ	Ғ	Ҕ	Җ	Ҙ	Ҝ
Ҡ	Ң	Ҥ	Ҧ	ҧ	Ҩ	ҩ	Ҫ	ҫ	ҽ

АБВ чшщ абв чшщ 0-9?! DELETE

0	1	2	3	4	5	6	7	8	9
-	.	,	&	?	!	(	)	/	'
_									

**АБВ**

АБВ чшщ абв чшщ 0-9?! DELETE

А	Б	В	Г	Д	Е	Ё	Ж	З	И
Й	К	Л	М	Н	О	П	Р	С	Т
У	Ф	Х	Ц	_					

АБВ чшщ абв чшщ 0-9?! DELETE

Ч	Ш	Щ	Ъ	Ы	Ь	Э	Ю	Я	Г
Є	І	Ї	Ў	Ғ	Ҕ	Җ	Ҙ	Ҝ	Ҟ
Ҡ	Ң	Ҥ	Ҧ	ҧ	Ҩ	ҩ	Ҫ	ҫ	ҽ

АБВ чшщ абв чшщ 0-9?! DELETE

а	б	в	г	д	е	ё	ж	з	и
й	к	л	м	н	о	п	р	с	т
у	ф	х	ц	_					

АБВ чшщ абв чшщ 0-9?! DELETE

ч	ш	щ	ъ	ы	ь	э	ю	я	г
є	і	ї	ў	ғ	Ғ	Ҕ	Җ	Ҙ	Ҝ
Ҡ	Ң	Ҥ	Ҧ	ҧ	Ҩ	ҩ	Ҫ	ҫ	ҽ

АБВ чшщ абв чшщ 0-9?! DELETE

0	1	2	3	4	5	6	7	8	9
-	.	,	&	?	!	(	)	/	'
_									



# Embroidery Pattern Color Change Table

## Tableau de changement de couleur des motifs de broderie

### Tabella di cambiamento colori degli schemi di ricamo

# Stickmuster-Farbtabelle

## Kleurwijzigingstabel voor de borduurpatronen

### Tabla de cambio de color para patrones de bordado

#### Embroidery patterns

#### Borduurpatronen

#### Stickmuster

#### Schemi di ricamo

#### Motifs de broderie

#### Patrones de bordado



Design patterns

Muster entwerfen

Création de motifs

Ontwerp patronen

Creazione di disegni

Diseño de patrones

**No.1 15 min**

1	(513)
2	(507)
3	(205)
4	(209)
5	(800)
6	(513)

Time required for embroidering  
Zeitaufwand beim Sticken  
Durée requise pour broder  
Tijd benodigd voor het borduren  
Tempo di ricamo necessario  
Tiempo requerido para el bordado

Embroidery thread color number  
Stickgarn-Farbnrmer  
Numéro de couleur du fil de broderie  
Kleurnummer borduurdraad  
Numero colori filo per ricamo  
Número de color del hilo de bordado

Embroidery size  
Größe der Stickerei  
Taille de la broderie  
Borduurgrootte  
Dimensioni del ricamo  
Tecla de tamaño

Order to embroider  
Stickreihenfolge  
Séquence pour broder  
Borduurvolgorde  
Sequenza operazioni di ricamo  
Orden para el bordador

Embroidery thread color  
Stickgarnfarbe  
Couleur du fil de broderie  
Kleur borduurdraad  
Colore filo ricamo  
Color del hilo de bordado

↓ 9.6 cm ↔ 9.3 cm

**No.10 3 min**

1	(620)
---	-------

↓ 3.1 cm ↔ 9.5 cm

**No.11 11 min**

1	(707)
---	-------

↓ 9.6 cm ↔ 6.6 cm

**No.2 14 min**

1	(502)
2	(534)
3	(502)
4	(019)
5	(405)
6	(208)

↓ 9.3 cm ↔ 9.6 cm

**No.6 3 min**

1	(507)
2	(800)

↓ 5.3 cm ↔ 5.8 cm

**No.12 9 min**

1	(620)
---	-------

↓ 9.5 cm ↔ 6.7 cm

**No.3 13 min**

1	(507)
2	(513)
3	(205)
4	(209)
5	(030)

↓ 7.7 cm ↔ 9.1 cm

**No.7 10 min**

1	(502)
2	(010)
3	(513)
4	(507)
5	(019)
6	(405)

↓ 6.8 cm ↔ 8.6 cm

**No.13 6 min**

1	(070)
---	-------

↓ 9.6 cm ↔ 5.1 cm

**No.4 15 min**

1	(513)
2	(323)
3	(085)
4	(323)
5	(205)

↓ 9.3 cm ↔ 9.6 cm

**No.8 12 min**

1	(079)
---	-------

↓ 9.0 cm ↔ 8.5 cm

**No.14 7 min**

1	(019)
---	-------

↓ 8.3 cm ↔ 9.6 cm

**No.5 3 min**

1	(070)
2	(079)

↓ 6.9 cm ↔ 6.3 cm

**No.9 11 min**

1	(507)
---	-------

↓ 9.5 cm ↔ 8.8 cm

**No.15 7 min**

1	(707)
---	-------

↓ 7.8 cm ↔ 8.7 cm

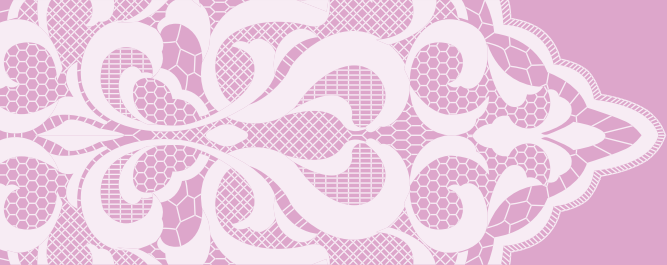

**No.16** **3 min**  
 1 (515)  
 ↓ 7.5 cm ↔ 4.2 cm



**No.22** **30 min**  
 1 (019)  
 2 (405)  
 3 (214)  
 4 (800)  
 5 (900)  
 ↓ 14.2 cm ↔ 11.6 cm



**No.26** **12 min**  
 1 (334)  
 2 (354)  
 3 (444)  
 4 (747)  
 5 (334)  
 6 (354)  
 7 (444)  
 8 (747)  
 ↓ 10.0 cm ↔ 12.9 cm

Country



**No.17** **4 min**  
 1 (515)  
 2 (405)  
 ↓ 6.6 cm ↔ 6.3 cm



**No.23** **48 min**  
 1 (513)  
 2 (515)  
 3 (205)  
 4 (010)  
 5 (208)  
 6 (085)  
 7 (810)  
 8 (001)  
 9 (086)  
 10 (612)  
 11 (800)  
 ↓ 16.7 cm ↔ 12.3 cm



**No.27** **38 min**  
 1 (509)  
 2 (206)  
 ↓ 9.6 cm ↔ 9.6 cm



**No.18** **14 min**  
 1 (534)  
 2 (010)  
 3 (205)  
 4 (900)  
 ↓ 6.2 cm ↔ 6.3 cm



**No.28** **24 min**  
 1 (513)  
 ↓ 9.5 cm ↔ 8.2 cm



**No.19** **9 min**  
 1 (515)  
 2 (405)  
 3 (800)  
 4 (328)  
 ↓ 8.4 cm ↔ 8.8 cm



**No.24** **23 min**  
 1 (214)  
 2 (058)  
 3 (900)  
 4 (800)  
 5 (070)  
 6 (502)  
 ↓ 16.6 cm ↔ 10.3 cm



**No.29** **3 min**  
 1 (623)  
 2 (370)  
 3 (623)  
 ↓ 5.2 cm ↔ 6.1 cm

Country



**No.20** **20 min**  
 1 (800)  
 2 (019)  
 3 (058)  
 4 (019)  
 5 (058)  
 6 (019)  
 7 (058)  
 ↓ 8.9 cm ↔ 9.4 cm

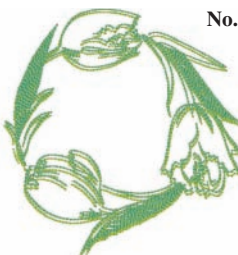

**No.25** **11 min**  
 1 (444)  
 2 (463)  
 ↓ 13.2 cm ↔ 12.6 cm

Country



**No.30** **11 min**  
 1 (122)  
 2 (747)  
 3 (015)  
 ↓ 9.1 cm ↔ 9.5 cm

Country

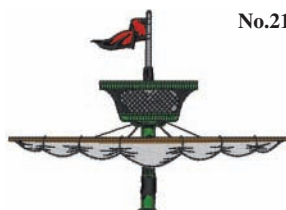

**No.21** **16 min**  
 1 (800)  
 2 (005)  
 3 (515)  
 4 (900)  
 5 (001)  
 6 (323)  
 7 (900)  
 ↓ 11.0 cm ↔ 15.2 cm



**No.31** **2 min**

1		(575)
---	--	-------

↓ 9.6 cm ↔ 3.9 cm

Country



● **No.36** **29 min**

1		(107)
2		(086)

↓ 20.4 cm ↔ 15.4 cm



**No.41** **20 min**

1		(515)
2		(810)
3		(206)
4		(620)

↓ 10.1 cm ↔ 10.3 cm



**No.32** **2 min**

1		(586)
---	--	-------

↓ 6.3 cm ↔ 4.6 cm

Country



● **No.37** **27 min**

1		(405)
2		(420)

↓ 20.4 cm ↔ 15.4 cm



**No.33** **2 min**

1		(015)
2		(575)

↓ 6.7 cm ↔ 6.6 cm

Country



● **No.38** **29 min**

1		(517)
2		(515)

↓ 20.4 cm ↔ 15.4 cm



**No.34** **7 min**

1		(024)
---	--	-------

↓ 8.8 cm ↔ 9.0 cm

Country



● **No.39** **28 min**

1		(007)
2		(405)

↓ 20.4 cm ↔ 15.4 cm



**No.35** **6 min**

1		(623)
---	--	-------

↓ 6.7 cm ↔ 7.4 cm

Country



**No.40** **20 min**

1		(328)
2		(620)

↓ 19.4 cm ↔ 15.5 cm

Patterns marked with ● have been rotated. Check your design placement prior to embroidering.

Muster, die mit ● gekennzeichnet sind, wurden gedreht. Überprüfen Sie die Platzierung Ihres Designs, bevor Sie mit Sticken beginnen.

Les motifs signalés par ● ont été pivotés. Vérifiez l'emplacement de votre motif avant de commencer à broder.

Patronen die zijn gemarkeerd met ● zijn gedraaid. Controleer de plaats van uw ontwerp voordat u gaat borduren.

I disegni contrassegnati dal simbolo ● appaiono ruotati. Prima di procedere al ricamo, verificare la posizione del disegno.

Los patrones marcados con ● se han girado. Compruebe la colocación del diseño antes de bordar.



Embroidery Pattern Color Change Table  
 Stickmuster-Farbtabelle  
 Tableau de changement de couleur des motifs de broderie  
 Kleurwijzigingstabel voor de borduurpatronen  
 Tabella di cambiamento colori degli schemi di ricamo  
 Tabla de cambio de color para patrones de bordado

**No.42** **26 min**



1	(515)
2	(810)
3	(206)
4	(620)

↓ 15.6 cm ↔ 15.6 cm

**No.46** **14 min**



1	(509)
2	(804)
3	(085)

↓ 11.9 cm ↔ 6.4 cm

★ **No.51** **5 min**



1	× (335)
2	× (473)
3	(473)
4	(473)
5	(255)
6	× (335)
7	× (335)
8	(336)
9	(000)
10	(255)

↓ 6.8 cm ↔ 8.5 cm

Country 

**No.47** **9 min**



1	(804)
2	(810)
3	(607)
4	(017)
5	(085)
6	(086)
7	(027)

↓ 6.3 cm ↔ 6.4 cm

★ **No.52** **2 min**



1	× (473)
2	× (473)
3	(473)
4	(255)

↓ 4.3 cm ↔ 6.7 cm

Country 

**No.43** **6 min**



1	(328)
---	-------

↓ 8.0 cm ↔ 7.7 cm

**No.48** **11 min**

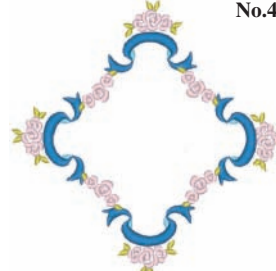

1	(017)
2	(019)
3	(027)
4	(124)

↓ 14.9 cm ↔ 14.8 cm

**No.53** **1 min**



1	(255)
2	(336)

↓ 2.5 cm ↔ 9.6 cm

Country 

**No.44** **16 min**



1	(124)
2	(612)
3	(017)

↓ 21.7 cm ↔ 14.7 cm

**No.49** **19 min**



1	(328)
2	(214)
3	(070)
4	(513)
5	(124)
6	(214)

↓ 12.0 cm ↔ 9.5 cm

**No.54** **6 min**



1	(512)
2	(003)
3	(564)

↓ 7.0 cm ↔ 4.1 cm

Country 

**No.45** **7 min**



1	(085)
2	(017)

↓ 15.0 cm ↔ 9.9 cm

**No.50** **11 min**



1	(124)
2	(085)
3	(810)
4	(612)
5	(513)
6	(214)

↓ 7.5 cm ↔ 7.5 cm

**No.55** **4 min**



1	(003)
2	(512)
3	(564)

↓ 4.0 cm ↔ 4.4 cm

Country 

**No.56** **3 min**



1	(575)
---	-------

↓ 6.8 cm ↔ 6.9 cm

Country 

**No.57** **3 min**



1	(126)
---	-------

↓ 8.7 cm ↔ 8.0 cm

Country 



No.58

13 min	
1	(334)
2	(224)
3	(334)
4	(512)
5	(224)

↓ 7.8 cm ↔ 17.6 cm

Country



★ No.60

12 min	
1	(513)
2	(513)
3	(513)
4	(513)
5	(348)
6	(323)
7	(206)

↓ 5.7 cm ↔ 14.7 cm



No.62

5 min	
1	(126)
2	(206)
3	(513)
4	(337)

↓ 10.0 cm ↔ 3.3 cm



No.59

18 min	
1	(348)
2	(337)
3	(126)
4	(206)
5	(513)

↓ 14.0 cm ↔ 13.7 cm



★ No.61

21 min	
1	(348)
2	(348)
3	(348)
4	(348)
5	(323)
6	(513)
7	(126)
8	(209)
9	(030)
10	(206)

↓ 6.7 cm ↔ 14.4 cm



No.63

2 min	
1	(206)
2	(513)

↓ 3.3 cm ↔ 2.9 cm

Quilt patterns

Quiltpatronen

Bordüren

Disegni per trapuntatura

Motifs piqués

Patrones de acolchado

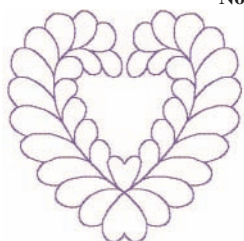

No.64

2 min	
1	(612)

↓ 12.5 cm ↔ 12.6 cm

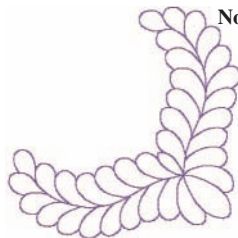

No.67

1 min	
1	(612)

↓ 12.6 cm ↔ 12.6 cm



No.69

1 min	
1	(612)

↓ 17.6 cm ↔ 5.7 cm



No.65

2 min	
1	(612)

↓ 12.5 cm ↔ 12.5 cm



No.68

1 min	
1	(612)

↓ 17.6 cm ↔ 6.3 cm



No.66

2 min	
1	(612)
2	(810)

↓ 12.6 cm ↔ 12.6 cm

- ★ Refer to the operation manual for the embroidery machine for details on how to embroider appliqués.
- ★ Weitere Hinweise zum Sticken von Applikationen finden Sie in der Bedienungsanleitung der Stickmaschine.
- ★ Reportez-vous au mode d'emploi de la machine à broder pour plus d'informations sur la broderie des appliqués.
- ★ In de bedieningshandleiding bij de borduurmachine leest u uitvoeriger hoe u applicaties borduurt.
- ★ Consultare il manuale di istruzioni della macchina da ricamo per i dettagli relativi al ricamo di appliqué.
- ★ Consulte el manual de instrucciones de la máquina de bordar si desea más información sobre cómo bordar apliques.

Embroidery Pattern Color Change Table  
 Stickmuster-Farbtabelle  
 Tableau de changement de couleur des motifs de broderie  
 Kleurwijzigingstabel voor de borduurpatronen  
 Tabella di cambiamento colori degli schemi di ricamo  
 Tabla de cambio de color para patrones de bordado

Decorative buttonhole patterns

Zierknopflochmuster

Motifs pour boutonnière décorative

Decoratieve knoopsgatpatronen

Disegni decorativi per asole

Costuras de ojales decorativas

**Note :** Touch  key in design selection screen to select one of the three sizes.

**Hinweis :** Wählen Sie mit der Taste  im Stickmustersauswahl-Bildschirm eine von drei Größen.



**Remarque :** appuyez sur la touche  de l'écran de sélection des motifs pour sélectionner l'une des trois tailles.

**Opmerking :** Druk op  toets in het ontwerpkeuzescherf om een van de drie formaten te kiezen.

**Nota :** premere il tasto  nella schermata di selezione dei disegni per selezionare una delle tre dimensioni.



**Nota :** toque la tecla  en la pantalla de selección de diseños para seleccionar uno de los tres tamaños.

**No.70**

2 min	
1	 (507)
2	 (800)
3	 (507)
L: $\downarrow$ 5.6 cm $\leftrightarrow$ 2.7 cm	
M: $\downarrow$ 5.1 cm $\leftrightarrow$ 2.6 cm	
S: $\downarrow$ 4.6 cm $\leftrightarrow$ 2.5 cm	





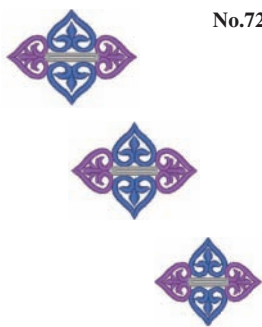

**No.72**

4 min	
1	 (070)
2	 (612)
3	 (005)
L: $\downarrow$ 5.5 cm $\leftrightarrow$ 7.4 cm	
M: $\downarrow$ 5.5 cm $\leftrightarrow$ 7.1 cm	
S: $\downarrow$ 5.0 cm $\leftrightarrow$ 6.0 cm	







**No.74**

3 min	
1	 (214)
2	 (208)
3	 (328)
4	 (214)
L: $\downarrow$ 2.8 cm $\leftrightarrow$ 6.7 cm	
M: $\downarrow$ 2.7 cm $\leftrightarrow$ 6.4 cm	
S: $\downarrow$ 2.5 cm $\leftrightarrow$ 5.9 cm	





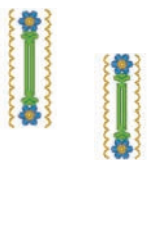

**No.71**

2 min	
1	 (513)
2	 (019)
3	 (208)
4	 (513)
L: $\downarrow$ 6.5 cm $\leftrightarrow$ 2.2 cm	
M: $\downarrow$ 5.9 cm $\leftrightarrow$ 2.0 cm	
S: $\downarrow$ 5.4 cm $\leftrightarrow$ 2.0 cm	



**No.73**

5 min	
1	 (086)
2	 (085)
3	 (070)
4	 (086)
L: $\downarrow$ 3.8 cm $\leftrightarrow$ 4.8 cm	
M: $\downarrow$ 3.6 cm $\leftrightarrow$ 4.6 cm	
S: $\downarrow$ 3.3 cm $\leftrightarrow$ 4.3 cm	

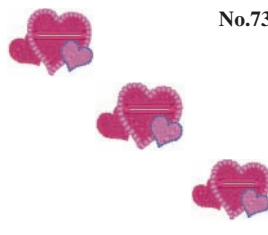

Border patterns

Randmuster



Motifs de bordure

Randpatronen

Disegni con bordi



Costuras con bordes

**No.75**

1 min	
1	 (513)
2	 (800)
$\downarrow$ 2.5 cm $\leftrightarrow$ 1.4 cm	







**No.76**

4 min	
1	 (513)
2	 (800)
$\downarrow$ 15.1 cm $\leftrightarrow$ 1.4 cm	







**No.77**

2 min	
1	 (513)
2	 (800)
3	 (070)
$\downarrow$ 7.9 cm $\leftrightarrow$ 2.3 cm	



**No.78**

5 min	
1	 (513)
2	 (800)
3	 (070)
$\downarrow$ 15.8 cm $\leftrightarrow$ 2.3 cm	





Designs using the Print and Stitch function

Motifs utilisant la fonction Imprimer et broder

Disegni che utilizzano la funzione Stampa & Ricama

Designs, die die Funktion Drucken und Sticken verwenden

Ontwerpen met de functie Print en Borduur

Diseños con la función Imprimir y coser



Background image  
Hintergrundbild  
Image d'arrière-plan  
Achtergrondafbeelding  
Immagine di sfondo  
Imagen de fondo



No.79

30 min

- |   |                 |
|---|-----------------|
| 1 | Blue (019)      |
| 2 | Dark Blue (405) |
| 3 | Yellow (214)    |
| 4 | Red (800)       |
| 5 | Black (900)     |

14.2 cm ↔ 11.6 cm

Embroidery pattern  
Stickmuster  
Motif de broderie  
Borduurpatroon  
Disegno da ricamo  
Patrón de bordado



No.80

12 min

- |   |                   |
|---|-------------------|
| 1 | Yellow (334)      |
| 2 | Orange (354)      |
| 3 | Light Green (444) |
| 4 | Black (747)       |
| 5 | Yellow (334)      |
| 6 | Orange (354)      |
| 7 | Light Green (444) |
| 8 | Black (747)       |

10.0 cm ↔ 12.9 cm

Country



No.81

20 min

- |   |              |
|---|--------------|
| 1 | Green (515)  |
| 2 | Pink (810)   |
| 3 | Yellow (206) |
| 4 | Purple (620) |

10.1 cm ↔ 10.3 cm



Refer to the operation manual for the sewing machine for details on how to embroider print and stitch patterns.

Weitere Einzelheiten zum Sticken der Druck- und Stickmuster finden Sie in der Bedienungsanleitung der Nähmaschine.

Reportez-vous au mode d'emploi de la machine à coudre pour de plus amples détails sur la broderie de motifs à imprimer et broder.

In de bedieningshandleiding bij de naaimachine vindt u meer bijzonderheden over het borduren met de functie Print en Borduur.

Fare riferimento al manuale d'istruzione della macchina da cucire per i dettagli su come ricamare i disegni stampa & ricama.

Para obtener más información sobre cómo bordar patrones de impresión y costura, consulte el manual de instrucciones de la máquina de coser.

↳ Brother "Exclusives"  
 Vintage designs

↳ "Exclusief" nostalgische  
 ontwerpen van Brother

↳ Brother-, "Auswahl":  
 Klassische Designs

↳ Disegni Vintage  
 "Esclusivi" Brother

↳ Motifs classiques Brother  
 « exclusifs »

↳ Diseños de época  
 "exclusivos" de Brother



**No.1** **58 min**

1	(019)
2	(017)
3	(420)
4	(019)
5	(420)

↓ 28.6 cm ↔ 17.0 cm



**No.3** **55 min**

1	(328)
2	(214)
3	(019)
4	(330)
5	(348)
6	(079)
7	(328)
8	(019)
9	(017)
10	(330)
11	(348)
12	(079)
13	(330)
14	(348)
15	(019)
16	(079)
17	(214)
18	(019)
19	(206)

↓ 23.8 cm ↔ 18.4 cm



**No.6** **18 min**

1	(348)
2	(214)
3	(339)
4	(843)

↓ 24.5 cm ↔ 6.6 cm



**No.2** **27 min**

1	(019)
2	(420)
3	(017)
4	(019)
5	(017)
6	(420)

↓ 28.2 cm ↔ 8.5 cm



**No.4** **10 min**

1	(328)
2	(019)
3	(017)
4	(330)
5	(348)
6	(079)
7	(214)
8	(019)
9	(206)

↓ 8.7 cm ↔ 13.1 cm



**No.7** **11 min**

1	(214)
2	(339)

↓ 14.4 cm ↔ 6.6 cm



**No.8** **16 min**

1	(406)
2	(323)
3	(330)
4	(323)
5	(330)
6	(406)
7	(542)
8	(328)

↓ 9.1 cm ↔ 9.3 cm



**No.5** **47 min**

1	(348)
2	(214)
3	(339)
4	(843)
5	(348)
6	(214)
7	(339)
8	(843)

↓ 25.8 cm ↔ 16.3 cm



**No.9** **14 min**

1	(405)
2	(348)
3	(107)
4	(058)
5	(517)
6	(405)
7	(107)
8	(328)
9	(307)
10	(348)
11	(058)
12	(405)

↓ 8.1 cm ↔ 9.7 cm



No.10

31 min	
1	(405)
2	(348)
3	(107)
4	(058)
5	(517)
6	(405)
7	(107)
8	(328)
9	(348)
10	(307)
11	(348)
12	(058)
13	(405)

↓ 17.4 cm ↔ 9.7 cm



No.13

17 min	
1	(017)
2	(019)
3	(513)
4	(812)
5	(017)
6	(612)
7	(085)
8	(017)
9	(019)
10	(513)
11	(812)
12	(017)
13	(612)
14	(085)
15	(513)
16	(017)
17	(019)
18	(812)
19	(017)
20	(085)
21	(612)

↓ 13.3 cm ↔ 12.5 cm



No.17

23 min	
1	(005)
2	(517)
3	(843)
4	(348)
5	(323)
6	(079)
7	(707)
8	(817)
9	(707)
10	(005)
11	(817)
12	(079)

↓ 13.4 cm ↔ 9.3 cm



No.11

19 min	
1	(399)
2	(214)
3	(399)
4	(214)
5	(399)

↓ 26.5 cm ↔ 19.5 cm



No.14

2 min	
1	(513)
2	(812)
3	(017)
4	(085)
5	(612)

↓ 2.7 cm ↔ 2.6 cm



No.18

6 min	
1	(005)
2	(817)
3	(079)

↓ 4.0 cm ↔ 9.3 cm



No.19

21 min	
1	(333)
2	(515)
3	(843)
4	(607)
5	(620)
6	(612)
7	(620)

↓ 9.6 cm ↔ 14.0 cm

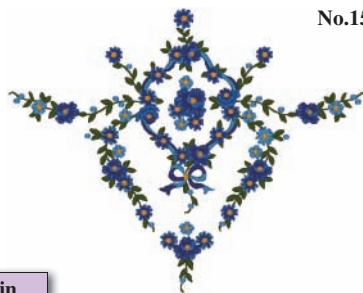

No.15

26 min	
1	(517)
2	(019)
3	(007)
4	(405)
5	(007)
6	(019)
7	(214)
8	(517)
9	(019)
10	(405)
11	(007)
12	(214)

↓ 15.2 cm ↔ 19.1 cm



No.20

10 min	
1	(612)
2	(333)
3	(612)
4	(620)

↓ 5.6 cm ↔ 12.3 cm



No.12

13 min	
1	(517)
2	(323)
3	(085)
4	(001)
5	(019)
6	(017)
7	(214)
8	(019)
9	(323)
10	(214)
11	(517)

↓ 8.7 cm ↔ 5.6 cm



No.16

7 min	
1	(019)
2	(405)
3	(007)
4	(517)
5	(405)
6	(019)
7	(007)
8	(214)

↓ 3.6 cm ↔ 9.3 cm



No.21

16 min	
1	(515)
2	(534)
3	(323)
4	(328)
5	(348)
6	(007)
7	(019)
8	(017)
9	(007)

↓ 4.8 cm ↔ 9.7 cm



Embroidery Pattern Color Change Table  
 Stickmuster-Farbtabelle  
 Tableau de changement de couleur des motifs de broderie  
 Kleurwijzigingstabel voor de borduurpatronen  
 Tabella di cambiamento colori degli schemi di ricamo  
 Tabla de cambio de color para patrones de bordado

**No.22** **15 min**

1	(399)
2	(005)
3	(515)
4	(534)
5	(323)
6	(079)
7	(019)
8	(017)
9	(328)
10	(348)
11	(328)
12	(323)

↓ 10.1 cm ↔ 4.6 cm



**No.26** **46 min**

1	(328)
2	(070)
3	(843)
4	(620)
5	(613)

↓ 19.4 cm ↔ 19.6 cm



**No.30** **43 min**

1	(405)
2	(107)
3	(507)
4	(206)
5	(107)
6	(405)
7	(206)
8	(019)
9	(507)
10	(107)
11	(405)
12	(507)
13	(206)
14	(019)
15	(107)
16	(405)
17	(507)
18	(206)
19	(019)

↓ 22.9 cm ↔ 17.2 cm

**No.23** **9 min**

1	(843)
---	-------

↓ 8.0 cm ↔ 10.4 cm

**No.24** **23 min**

1	(348)
2	(405)
3	(406)
4	(348)
5	(405)
6	(406)

↓ 16.3 cm ↔ 11.9 cm

**No.27** **9 min**

1	(515)
2	(542)
3	(214)
4	(800)
5	(420)
6	(406)
7	(800)

↓ 5.9 cm ↔ 14.4 cm



**No.28** **1 min**

1	(515)
2	(420)
3	(542)
4	(800)
5	(214)

↓ 2.1 cm ↔ 1.8 cm



**No.31** **6 min**

1	(107)
2	(507)
3	(405)
4	(206)
5	(019)
6	(405)
7	(107)
8	(507)
9	(206)

↓ 10.6 cm ↔ 5.4 cm

Guideline for the collar  
 Hilfslinie für den Kragen  
 Ligne de guidage pour le col  
 Hulplijn voor de kraag  
 Linea guida per il colletto  
 Instrucciones para el cuello



**No.29** **15 min**

1	(515)
2	(542)
3	(214)
4	(800)
5	(420)
6	(406)
7	(515)
8	(542)
9	(214)
10	(800)
11	(406)
12	(420)
13	(515)
14	(542)
15	(214)
16	(800)
17	(406)
18	(420)
19	(800)
20	(406)
21	(399)

↓ 14.5 cm ↔ 14.8 cm



**No.32** **51 min**

1	(800)
2	(209)
3	(205)
4	(513)
5	(507)
6	(614)
7	(405)

↓ 22.6 cm ↔ 19.8 cm

**No.25** **78 min**

1	(070)
2	(843)
3	(328)
4	(620)
5	(613)

↓ 18.0 cm ↔ 18.7 cm



**No.33** **20 min**

1	(507)
2	(513)
3	(205)
4	(800)
5	(209)
6	(614)
7	(405)

↓ 23.0 cm ↔ 10.3 cm

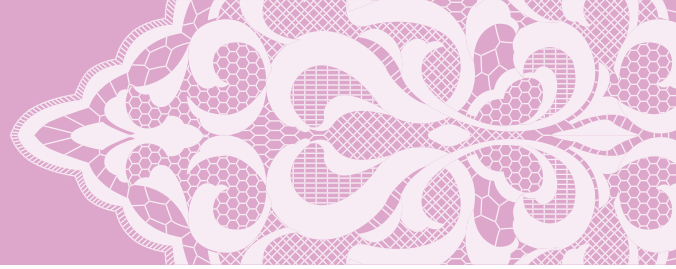

**● No.34** **15 min**



1	■	(507)
2	■	(513)
3	■	(614)
4	■	(405)

⇅ 21.8 cm ⇔ 7.4 cm

**No.37** **9 min**

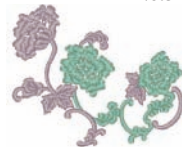

1	■	(399)
2	■	(542)
3	■	(399)

⇅ 7.9 cm ⇔ 9.5 cm

**No.40** **23 min**

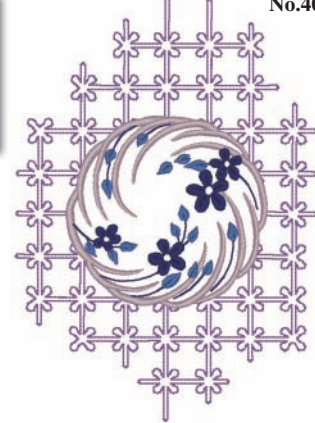

1	■	(612)
2	■	(399)
3	■	(007)
4	■	(070)

⇅ 23.0 cm ⇔ 16.3 cm

**No.35** **7 min**



1	■	(205)
2	■	(800)
3	■	(209)
4	■	(507)
5	■	(513)
6	■	(614)
7	■	(405)

⇅ 4.1 cm ⇔ 9.2 cm

**No.38** **5 min**



1	■	(420)
2	■	(030)
3	■	(337)
4	■	(330)
5	■	(420)
6	■	(307)

⇅ 9.0 cm ⇔ 5.8 cm

**No.36** **17 min**



1	■	(085)
2	■	(502)
3	■	(019)
4	■	(208)
5	■	(085)
6	■	(017)
7	■	(405)
8	■	(502)
9	■	(001)
10	■	(019)
11	■	(208)

⇅ 7.1 cm ⇔ 7.0 cm

**No.39** **11 min**



1	■	(019)
2	■	(405)

⇅ 9.6 cm ⇔ 9.9 cm

Patterns marked with ● have been rotated. Check your design placement prior to embroidering.  
 Muster, die mit ● gekennzeichnet sind, wurden gedreht.  
 Überprüfen Sie die Platzierung Ihres Designs, bevor Sie mit Sticken beginnen.  
 Les motifs signalés par ● ont été pivotés. Vérifiez l'emplacement de votre motif avant de commencer à broder.  
 Patronen die zijn gemarkeerd met ● zijn gedraaid.  
 Controleer de plaats van uw ontwerp voordat u gaat borduren.  
 I disegni contrassegnati dal simbolo ● appaiono ruotati.  
 Prima di procedere al ricamo, verificare la posizione del disegno.  
 Los patrones marcados con ● se han girado. Compruebe la colocación del diseño antes de bordar.

Brother "Exclusives"  
 Monogram designs

"Exclusief" monogramontwerpen van Brother

Brother-, „Auswahl“:  
 Monogrammdesigns

Disegni monogramma  
 "Esclusivi" Brother

Motifs monogrammes  
 Brother « exclusifs »

Diseños de monogramas  
 "exclusivos" de Brother



**No.1**

3 min
1 (000)
2 (461)
3 (442)
↓ 3.9 cm ↔ 4.6 cm



**No.6**

2 min
1 (000)
2 (152)
3 (155)
↓ 3.8 cm ↔ 3.4 cm



**No.11**

2 min
1 (000)
2 (604)
3 (623)
↓ 3.8 cm ↔ 5.1 cm



**No.2**

3 min
1 (000)
2 (331)
3 (334)
↓ 3.9 cm ↔ 4.2 cm



**No.7**

3 min
1 (000)
2 (461)
3 (442)
↓ 3.8 cm ↔ 3.5 cm



**No.12**

3 min
1 (000)
2 (152)
3 (155)
↓ 3.8 cm ↔ 4.4 cm



**No.3**

3 min
1 (000)
2 (020)
3 (012)
↓ 3.9 cm ↔ 3.7 cm



**No.8**

3 min
1 (000)
2 (334)
↓ 3.8 cm ↔ 4.4 cm



**No.13**

3 min
1 (000)
2 (461)
3 (442)
↓ 3.8 cm ↔ 5.9 cm



**No.4**

3 min
1 (000)
2 (512)
3 (003)
↓ 3.9 cm ↔ 4.0 cm



**No.9**

2 min
1 (000)
2 (020)
3 (012)
↓ 3.8 cm ↔ 3.3 cm



**No.14**

2 min
1 (000)
2 (331)
3 (334)
↓ 3.6 cm ↔ 5.3 cm



**No.5**

2 min
1 (000)
2 (604)
3 (623)
↓ 3.8 cm ↔ 3.2 cm



**No.10**

2 min
1 (000)
2 (512)
3 (003)
↓ 4.3 cm ↔ 3.7 cm



**No.15**

2 min
1 (000)
2 (020)
3 (012)
↓ 3.8 cm ↔ 3.1 cm





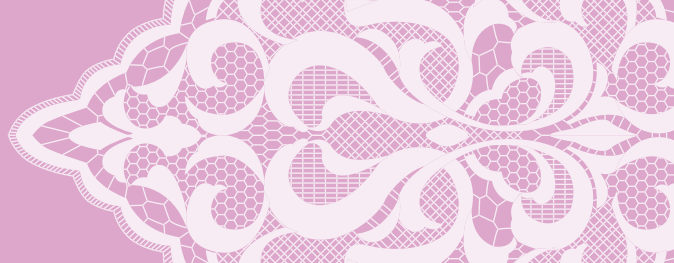

**No.16**



**2 min**

1	(000)
2	(003)

↓ 3.8 cm ↔ 4.0 cm

Country 

**No.22**



**2 min**

1	(000)
2	(512)
3	(003)

↓ 3.8 cm ↔ 4.7 cm

Country 

**No.27**



**13 min**

1	(000)
2	(370)
3	(335)

↓ 8.7 cm ↔ 12.4 cm

Country 

**No.17**



**3 min**

1	(000)
2	(604)
3	(623)

↓ 3.7 cm ↔ 3.0 cm

Country 

**No.23**



**3 min**

1	(000)
2	(512)
3	(623)

↓ 3.7 cm ↔ 5.0 cm

Country 

**No.28**



**16 min**

1	(000)
2	(003)
3	(604)

↓ 10.8 cm ↔ 12.8 cm

Country 

**No.18**



**3 min**

1	(000)
2	(152)
3	(155)

↓ 3.7 cm ↔ 4.7 cm

Country 

**No.24**



**3 min**

1	(000)
2	(152)
3	(155)

↓ 3.9 cm ↔ 5.3 cm

Country 

**No.29**



**13 min**

1	(000)
2	(623)
3	(604)

↓ 10.4 cm ↔ 12.3 cm

Country 

**No.19**



**2 min**

1	(000)
2	(461)
3	(442)

↓ 3.7 cm ↔ 3.3 cm

Country 

**No.25**



**2 min**

1	(000)
2	(442)
3	(461)

↓ 3.8 cm ↔ 4.3 cm

Country 

**No.30**



**13 min**

1	(000)
2	(442)
3	(025)

↓ 8.9 cm ↔ 11.9 cm

Country 

**No.20**



**2 min**

1	(000)
2	(331)
3	(334)

↓ 3.7 cm ↔ 4.3 cm

Country 

**No.26**



**2 min**

1	(000)
2	(334)
3	(331)

↓ 3.8 cm ↔ 3.7 cm

Country 

**No.21**



**2 min**

1	(000)
2	(012)
3	(020)

↓ 3.8 cm ↔ 4.1 cm

Country 

Patterns No.1 - No.30, are designed by Yuki Pallis.  
 Muster Nr. 1 – Nr. 30 wurden von Yuki Pallis entworfen.  
 Les motifs 1 à 30 ont été conçus par Yuki Pallis.  
 De patronen 1 – 30 zijn ontwikkeld door Yuki Pallis.  
 I disegni dal N. 1 al N. 30 sono stati realizzati da Yuki Pallis.  
 Los patrones del n° 1 al n° 30 han sido diseñados por Yuki Pallis.

Brother "Exclusives"  
 New European designs

"Exclusief" nieuwe  
 Europese ontwerpen van  
 Brother

Brother-, "Auswahl":  
 Neue europäische Designs

Disegni novità europee  
 "Esclusivi" Brother

Motifs européens nouveauté  
 Brother « exclusifs »

Diseños de la Nueva  
 Europa "exclusivos" de  
 Brother



**No.1 9 min**

1	Black (900)
2	Red (030)

↓ 10.1 cm ↔ 19.6 cm

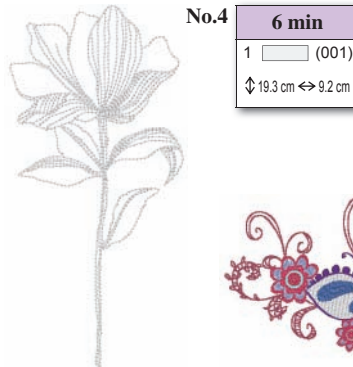

**No.4 6 min**

1	White (001)
---	-------------

↓ 19.3 cm ↔ 9.2 cm

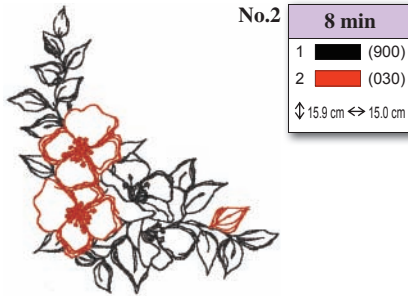

**No.2 8 min**

1	Black (900)
2	Red (030)

↓ 15.9 cm ↔ 15.0 cm

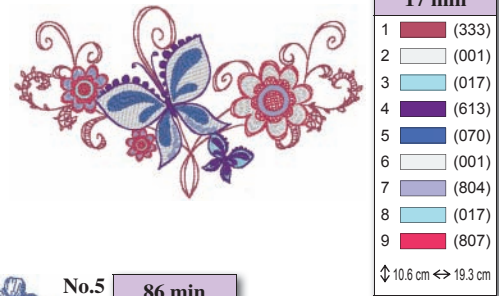

**No.7 17 min**

1	Red (333)
2	White (001)
3	Light Blue (017)
4	Dark Purple (613)
5	Blue (070)
6	White (001)
7	Light Purple (804)
8	Light Blue (017)
9	Red (807)

↓ 10.6 cm ↔ 19.3 cm

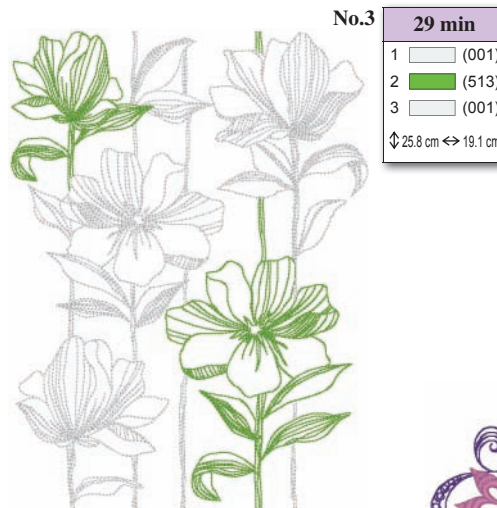

**No.3 29 min**

1	White (001)
2	Green (513)
3	White (001)

↓ 25.8 cm ↔ 19.1 cm

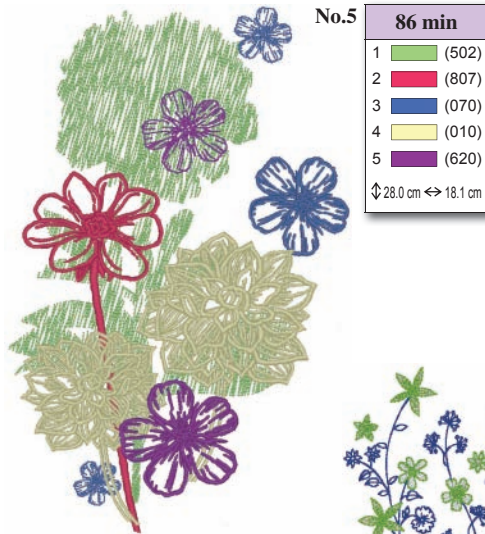

**No.5 86 min**

1	Green (502)
2	Red (807)
3	Blue (070)
4	Yellow (010)
5	Purple (620)

↓ 28.0 cm ↔ 18.1 cm

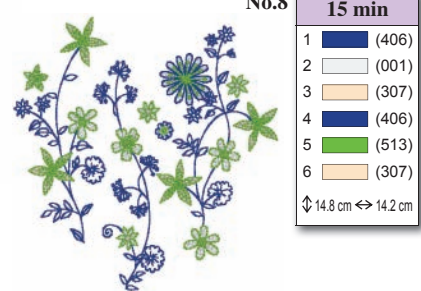

**No.8 15 min**

1	Dark Blue (406)
2	White (001)
3	Orange (307)
4	Dark Blue (406)
5	Green (513)
6	Orange (307)

↓ 14.8 cm ↔ 14.2 cm

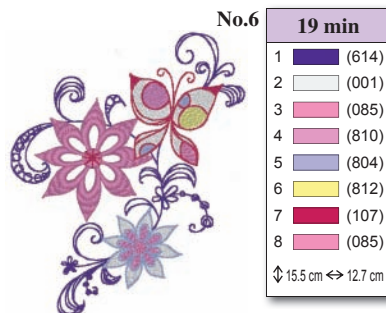

**No.6 19 min**

1	Purple (614)
2	White (001)
3	Pink (085)
4	Pink (810)
5	Light Purple (804)
6	Yellow (812)
7	Red (107)
8	Pink (085)

↓ 15.5 cm ↔ 12.7 cm

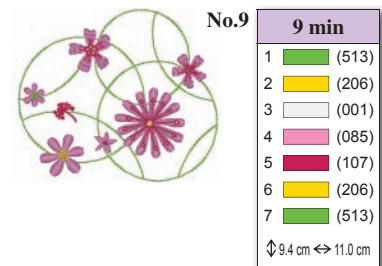

**No.9 9 min**

1	Green (513)
2	Yellow (206)
3	White (001)
4	Pink (085)
5	Red (107)
6	Yellow (206)
7	Green (513)

↓ 9.4 cm ↔ 11.0 cm

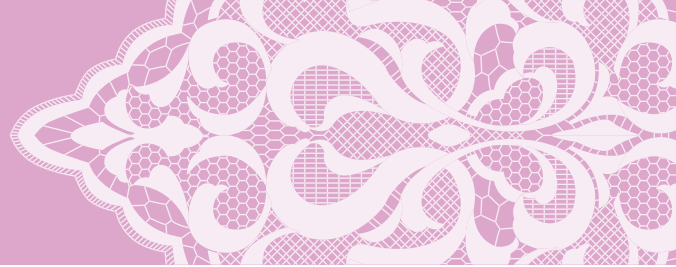

★ No.10

7 min	
1	---x (513)
2	--- (513)
3	--- (513)
4	■ (515)
5	□ (001)
↓ 9.8 cm ↔ 8.8 cm	



No.14

7 min	
1	■ (007)
2	■ (019)
3	■ (007)
4	■ (399)
5	■ (005)
6	■ (070)
↓ 7.2 cm ↔ 9.2 cm	



No.18

30 min	
1	■ (612)
2	■ (086)
3	■ (620)
4	□ (001)
5	■ (086)
6	■ (900)
7	■ (620)
8	■ (612)
9	■ (086)
10	■ (620)
11	□ (001)
12	■ (900)
13	■ (620)
↓ 15.4 cm ↔ 15.0 cm	

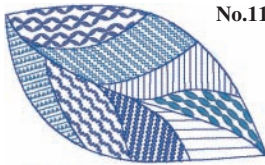

No.11

36 min	
1	■ (019)
2	■ (070)
3	■ (405)
4	■ (810)
5	■ (612)
6	■ (613)
7	■ (502)
8	■ (509)
9	■ (515)
↓ 27.2 cm ↔ 14.0 cm	

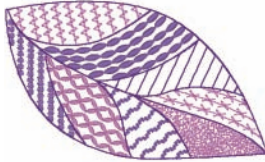

No.15

6 min	
1	■ (323)
2	■ (079)
3	■ (348)
4	■ (517)
5	■ (348)
6	■ (079)
7	■ (323)
↓ 9.3 cm ↔ 5.9 cm	



No.19

2 min	
1	■ (620)
2	■ (612)
3	■ (086)
↓ 7.0 cm ↔ 2.3 cm	

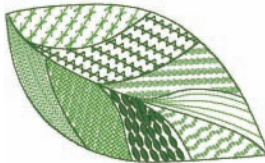

No.16

10 min	
1	■ (348)
2	■ (337)
3	■ (323)
4	■ (337)
↓ 8.3 cm ↔ 10.4 cm	



No.20

55 min	
1	■ (620)
2	■ (086)
3	□ (001)
4	■ (900)
5	■ (620)
6	■ (086)
7	■ (612)
8	■ (086)
9	□ (001)
10	■ (900)
11	■ (620)
12	■ (612)
13	■ (086)
14	■ (620)
15	■ (900)
16	■ (620)
17	■ (086)
18	■ (612)
19	■ (086)
20	□ (001)
21	■ (900)
22	■ (620)
↓ 27.6 cm ↔ 19.4 cm	

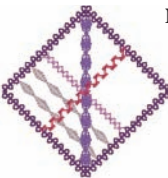

No.12

5 min	
1	■ (810)
2	■ (399)
3	■ (612)
4	■ (869)
5	■ (807)
↓ 9.4 cm ↔ 9.1 cm	



No.13

10 min	
1	■ (017)
2	■ (007)
3	■ (085)
4	■ (086)
5	■ (107)
6	■ (086)
7	■ (107)
↓ 13.6 cm ↔ 6.5 cm	

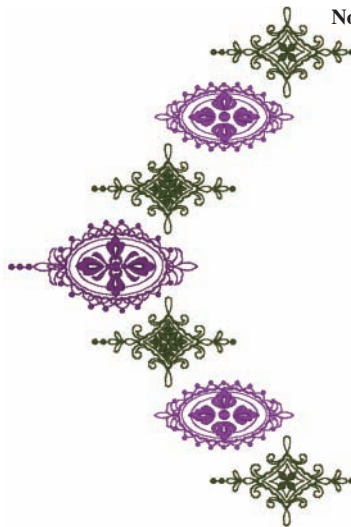

No.17

19 min	
1	■ (869)
2	■ (517)
3	■ (620)
4	■ (517)
↓ 27.9 cm ↔ 18.5 cm	

- ★ Refer to the operation manual for the embroidery machine for details on how to embroider appliqués.
- ★ Weitere Hinweise zum Sticken von Applikationen finden Sie in der Bedienungsanleitung der Stickmaschine.
- ★ Reportez-vous au mode d'emploi de la machine à broder pour plus d'informations sur la broderie des appliqués.
- ★ In de bedieningshandleiding bij de borduurmachine leest u uitvoeriger hoe u applicaties borduurt.
- ★ Consultare il manuale di istruzioni della macchina da ricamo per i dettagli relativi al ricamo di appliqué.
- ★ Consulte el manual de instrucciones de la máquina de bordar si desea más información sobre cómo bordar apliqués.



**Embroidery Pattern Color Change Table**  
**Stickmuster-Farbtabelle**  
**Tableau de changement de couleur des motifs de broderie**  
**Kleurwijzigingstabel voor de borduurpatronen**  
**Tabella di cambiamento colori degli schemi di ricamo**  
**Tabla de cambio de color para patrones de bordado**



**No.21**

57 min	
1	■ (406)
2	■ (420)
3	■ (399)
4	■ (420)
5	■ (399)

↕ 23.4 cm ↔ 19.0 cm

Designs using the Print and Stitch function

Motifs utilisant la fonction Imprimer et broder

Disegni che utilizzano la funzione Stampa & Ricama

Designs, die die Funktion Drucken und Sticken verwenden

Ontwerpen met de functie Print en Borduur

Diseños con la función Imprimir y coser



**No.22**

87 min	
1	■ (079)
2	■ (800)
3	■ (079)
4	■ (001)
5	■ (515)
6	■ (513)
7	■ (079)
8	■ (001)
9	■ (208)
10	■ (005)
11	■ (079)
12	■ (001)
13	■ (208)
14	■ (005)

↕ 19.0 cm ↔ 19.2 cm



**No.23**

77 min	
1	■ (502)
2	■ (206)
3	■ (513)
4	■ (534)
5	■ (804)
6	■ (086)
7	■ (208)
8	■ (085)
9	■ (001)

↕ 24.7 cm ↔ 19.3 cm



**Background image**  
**Hintergrundbild**  
**Image d'arrière-plan**  
**Achtergrondaafbeelding**  
**Immagine di sfondo**  
**Imagen de fondo**

**Embroidery pattern**  
**Stickmuster**  
**Motif de broderie**  
**Borduurpatroon**  
**Disegno da ricamo**  
**Patrón de bordado**



86 min			
1	■ (001)	16	■ (515)
2	■ (339)	17	■ (507)
3	■ (058)	18	■ (808)
4	■ (515)	19	■ (001)
5	■ (507)	20	■ (800)
6	■ (808)	21	■ (107)
7	■ (001)	22	■ (843)
8	■ (800)	23	■ (707)
9	■ (107)	24	■ (800)
10	■ (515)	25	■ (107)
11	■ (507)	26	■ (707)
12	■ (808)	27	■ (208)
13	■ (001)	28	■ (337)
14	■ (800)	29	■ (001)
15	■ (107)	30	■ (707)

↕ 25.6 cm ↔ 19.0 cm

Refer to the operation manual for the sewing machine for details on how to embroider print and stitch patterns.  
 Weitere Einzelheiten zum Sticken der Druck- und Stickmuster finden Sie in der Bedienungsanleitung der Nähmaschine.  
 Reportez-vous au mode d'emploi de la machine à coudre pour de plus amples détails sur la broderie de motifs à imprimer et broder.  
 In de bedieningshandleiding bij de naaimachine vindt u meer bijzonderheden over het borduren met de functie Print en Borduur.  
 Fare riferimento al manuale d'istruzione della macchina da cucire per i dettagli su come ricamare i disegni stampa & ricama.  
 Para obtener más información sobre cómo bordar patrones de impresión y costura, consulte el manual de instrucciones de la máquina de coser.

Patterns marked with ● have been rotated. Check your design placement prior to embroidering.  
 Muster, die mit ● gekennzeichnet sind, wurden gedreht. Überprüfen Sie die Platzierung Ihres Designs, bevor Sie mit Sticken beginnen.  
 Les motifs signalés par ● ont été pivotés. Vérifiez l'emplacement de votre motif avant de commencer à broder.  
 Patronen die zijn gemarkeerd met ● zijn gedraaid. Controleer de plaats van uw ontwerp voordat u gaat borduren.  
 I disegni contrassegnati dal simbolo ● appaiono ruotati. Prima di procedere al ricamo, verificare la posizione del disegno.  
 Los patrones marcados con ● se han girado. Compruebe la colocación del diseño antes de bordar.

HINT / TIPP / CONSEIL /  
TIP / SUGGERIMENTO /  
CONSEJO

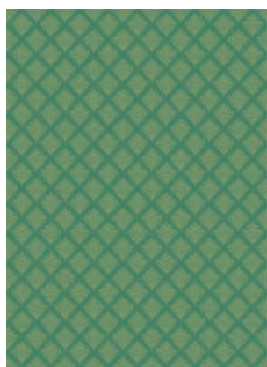

No.25

79 min

1	(612)
2	(620)
3	(614)
4	(807)
5	(086)
6	(107)
7	(534)
8	(405)
9	(900)
10	(612)
11	(620)
12	(614)
13	(807)
14	(086)
15	(107)
16	(534)
17	(405)
18	(900)
19	(107)
20	(612)
21	(900)
22	(534)
23	(086)
24	(614)
25	(900)
26	(614)

↕ 25.7 cm ↔ 15.5 cm



No.26

14 min

1	(001)
---	-------

↕ 16.6 cm ↔ 16.9 cm



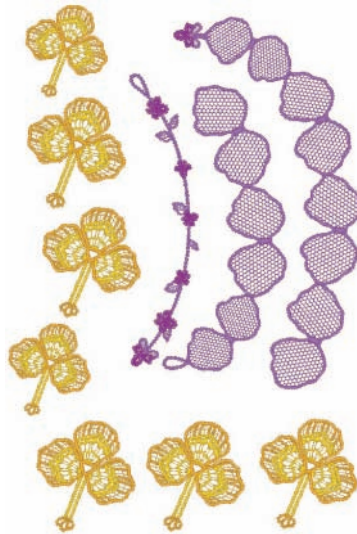

No.27

84 min	
1	(612)
2	(620)
3	(612)
4	(620)
5	(208)
6	(206)
7	(208)
8	(206)
9	(208)
10	(206)
11	(208)
12	(206)
13	(208)
14	(206)
15	(208)
16	(206)
17	(208)
18	(206)
19	(208)
↕ 28.4 cm ↔ 19.1 cm	

68

No.30

12 min	
1	(005)
2	(070)
3	(704)
4	(612)
↕ 16.9 cm ↔ 16.9 cm	

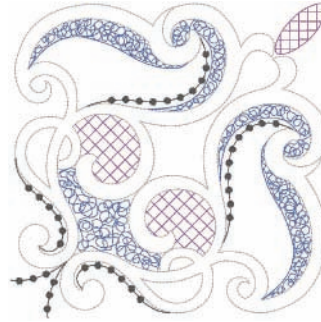

No.28

15 min	
1	(348)
2	(085)
3	(086)
4	(513)
5	(085)
6	(086)
7	(348)
↕ 26.8 cm ↔ 13.4 cm	



No.29

13 min	
1	(019)
2	(509)
3	(209)
4	(019)
5	(509)
↕ 16.8 cm ↔ 16.8 cm	



◁ Brother “Exclusives”  
Japanese designs

◁ “Exclusief” Japanse  
ontwerpen van Brother



**No.1**

82 min			
1	(030)	17	(307)
2	(001)	18	(214)
3	(337)	19	(307)
4	(307)	20	(019)
5	(019)	21	(214)
6	(214)	22	(517)
7	(307)	23	(812)
8	(019)	24	(515)
9	(214)	25	(058)
10	(307)	26	(001)
11	(058)	27	(307)
12	(001)	28	(030)
13	(030)	29	(214)
14	(337)	30	(058)
15	(307)	31	(707)
16	(019)	32	(058)

↓ 24.5 cm ↔ 11.1 cm

Designs using the Print and Stitch function

Motifs utilisant la fonction Imprimer et broder

Disegni che utilizzano la funzione Stampa & Ricama

◁ Brother-„Auswahl“:  
Japanische Designs

◁ Disegni giapponesi  
“Esclusivi” Brother



**No.2**

65 min			
1	(001)	11	(337)
2	(843)	12	(348)
3	(307)	13	(323)
4	(323)	14	(058)
5	(337)	15	(001)
6	(348)	16	(307)
7	(323)	17	(812)
8	(058)	18	(337)
9	(001)	19	(707)
10	(307)	20	(058)

↓ 24.3 cm ↔ 11.1 cm

Designs, die die Funktion Drucken und Sticken verwenden

Ontwerpen met de functie Print en Borduur

Diseños con la función Imprimir y coser



Background image  
Hintergrundbild  
Image d’arrière-plan  
Achtergrondafbeelding  
Immagine di sfondo  
Imagen de fondo

No.1



Embroidery pattern  
Stickmuster  
Motif de broderie  
Borduurpatroon  
Disegno da ricamo  
Patrón de bordado



No.2

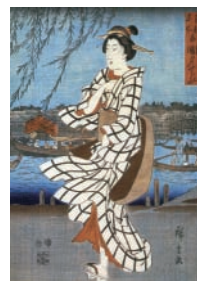

Refer to the operation manual for the sewing machine for details on how to embroider print and stitch patterns.

Weitere Einzelheiten zum Sticken der Druck- und Stickmuster finden Sie in der Bedienungsanleitung der Nähmaschine.

Reportez-vous au mode d’emploi de la machine à coudre pour de plus amples détails sur la broderie de motifs à imprimer et broder.

In de bedieningshandleiding bij de naaimachine vindt u meer bijzonderheden over het borduren met de functie Print en Borduur.

Fare riferimento al manuale d’istruzione della macchina da cucire per i dettagli su come ricamare i disegni stampa & ricama.

Para obtener más información sobre cómo bordar patrones de impresión y costura, consulte el manual de instrucciones de la máquina de coser.

Embroidery Pattern Color Change Table  
 Stickmuster-Farbtabelle  
 Tableau de changement de couleur des motifs de broderie  
 Kleurwijzigingstabel voor de borduurpatronen  
 Tabella di cambiamento colori degli schemi di ricamo  
 Tabla de cambio de color para patrones de bordado



**No.3 93 min**

1	(017)
2	(900)
3	(086)
4	(214)
5	(323)
6	(900)
7	(214)
8	(086)
9	(124)
10	(614)
11	(517)
12	(519)
13	(515)
14	(513)
15	(509)
16	(010)
17	(804)
18	(206)
19	(030)
20	(017)
21	(804)
22	(086)
23	(206)
24	(614)
25	(206)
26	(208)
27	(010)
28	(079)
29	(086)
30	(124)
31	(513)
32	(206)
33	(030)
34	(800)
35	(126)
36	(206)

Country (Country icon)

↓ 23.5 cm ↔ 16.2 cm



**No.5 42 min**

1	(100)
2	(148)

Country (Country icon)

↓ 20.3 cm ↔ 17.7 cm

Zen (Zen)  
 Zen (Zen)  
 Zen (Zen)  
 Zen (Zen)  
 Zen (Zen)  
 Zen (Zen)



**No.8 10 min**

1	(100)
2	(148)

Country (Country icon)

↓ 9.2 cm ↔ 10.1 cm

The sky (Ten)  
 Der Himmel (Ten)  
 Le ciel (Ten)  
 Hemel (Ten)  
 Il cielo (Ten)  
 Cielo (Ten)



**No.6 27 min**

1	(100)
2	(148)

Country (Country icon)

↓ 13.3 cm ↔ 15.9 cm

Dragon (Ryuu)  
 Drache (Ryuu)  
 Dragon (Ryuu)  
 Draak (Ryuu)  
 Dragone (Ryuu)  
 Dragón (Ryuu)



**No.9 14 min**

1	(100)
2	(148)

Country (Country icon)

↓ 12.0 cm ↔ 9.3 cm

Dream (Yume)  
 Traum (Yume)  
 Rêve (Yume)  
 Droom (Yume)  
 Sogno (Yume)  
 Sueño (Yume)



**No.4 15 min**

1	(100)
2	(148)

Country (Country icon)

↓ 11.0 cm ↔ 10.6 cm

Love (Ai)  
 Liebe (Ai)  
 Amour (Ai)  
 Liefde (Ai)  
 Amore (Ai)  
 Amor (Ai)



**No.7 11 min**

1	(100)
2	(148)

Country (Country icon)

↓ 10.2 cm ↔ 6.9 cm

Good fortune (Kichi)  
 Glück und Erfolg (Kichi)  
 Chance (Kichi)  
 Geluk (Kichi)  
 Buona fortuna (Kichi)  
 Buena suerte (Kichi)



**No.10 4 min**

1	(100)
2	(148)

Country (Country icon)

↓ 8.0 cm ↔ 4.9 cm

Friendship (Yuujou)  
 Freundschaft (Yuujou)  
 Amitié (Yuujou)  
 Vriendschap (Yuujou)  
 Amicizia (Yuujou)  
 Amistad (Yuujou)

Patterns No.4 – No.10, are designed by Taisen Okamoto.  
 Muster Nr.4 – Nr. 10 wurden von Taisen Okamoto entworfen.  
 Les motifs 4 à 10 ont été conçus par Taisen Okamoto.  
 De patronen 4 – 10 zijn ontwikkeld door Taisen Okamoto.  
 I disegni dal N.4 al N. 10 sono stati realizzati da Taisen Okamoto.  
 Los patrones del n° 4 al n° 10 han sido diseñados por Taisen Okamoto.



◁ Brother “Exclusives” Quilt designs

◁ “Exclusief” quiltontwerpen van Brother

◁ Brother-„Auswahl“: Quilt designs

◁ Disegni per trapuntatura “Eclusivi” Brother

◁ Motifs piqués Brother « exclusifs »

◁ Diseños de acolchado “exclusivos” de Brother

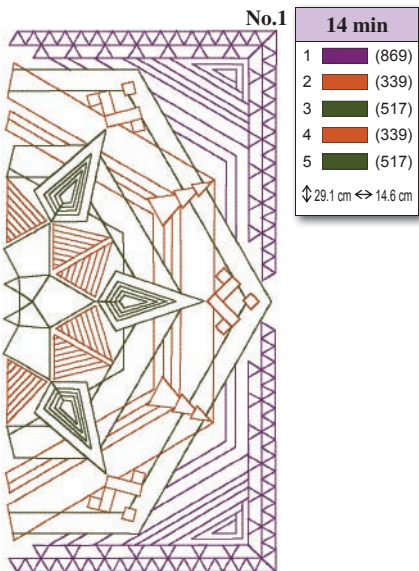

**No.1** 14 min

1	■ (869)
2	■ (339)
3	■ (517)
4	■ (339)
5	■ (517)

↕ 29.1 cm ↔ 14.6 cm



**No.4** 6 min

1	■ (030)
---	---------

↕ 28.2 cm ↔ 14.1 cm

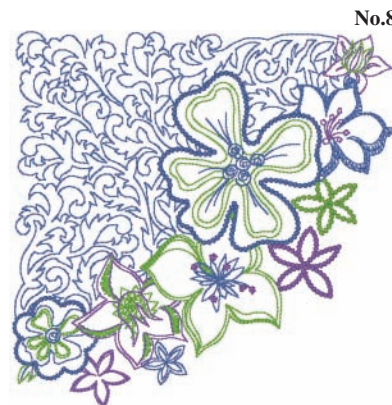

**No.8** 24 min

1	■ (070)
2	■ (513)
3	■ (070)
4	■ (612)
5	■ (513)

↕ 20.0 cm ↔ 19.8 cm

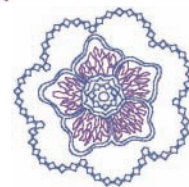

**No.9** 2 min

1	■ (612)
2	■ (070)

↕ 9.9 cm ↔ 10.0 cm

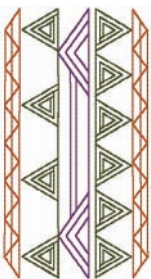

**No.2** 4 min

1	■ (869)
2	■ (517)
3	■ (339)

↕ 14.5 cm ↔ 7.7 cm



**No.5** 1 min

1	■ (330)
---	---------

↕ 14.0 cm ↔ 3.5 cm



**No.10** 5 min

1	■ (005)
2	■ (612)

↕ 26.9 cm ↔ 7.8 cm



**No.3** 5 min

1	■ (030)
---	---------

↕ 28.4 cm ↔ 14.3 cm

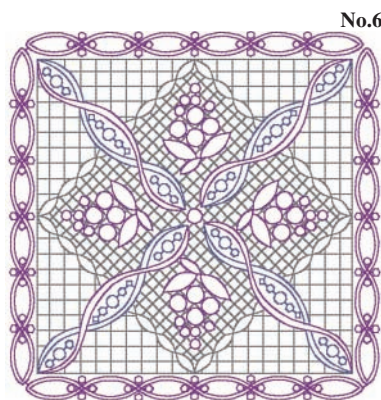

**No.6** 28 min

1	■ (817)
2	■ (620)
3	■ (817)
4	■ (620)
5	■ (607)
6	■ (817)
7	■ (620)
8	■ (607)
9	■ (817)
10	■ (620)
11	■ (607)
12	■ (620)

↕ 19.9 cm ↔ 19.9 cm

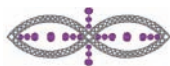

**No.7** 2 min

1	■ (817)
2	■ (620)

↕ 3.2 cm ↔ 9.1 cm



**No.11** 5 min

1	■ (209)
2	■ (509)

↕ 27.9 cm ↔ 7.6 cm



Embroidery Pattern Color Change Table  
 Stickmuster-Farbtabelle  
 Tableau de changement de couleur des motifs de broderie  
 Kleurwijzigingstabel voor de borduurpatronen  
 Tabella di cambiamento colori degli schemi di ricamo  
 Tabla de cambio de color para patrones de bordado

**No.12**

18 min	
1	(607)
2	(817)
3	(086)
4	(085)
5	(817)
6	(620)
7	(817)

↓ 27.9 cm ↔ 13.4 cm

**No.15**

3 min	
1	(030)
2	(323)

↓ 27.8 cm ↔ 7.0 cm

**No.19**

4 min	
1	(509)
2	(620)

↓ 7.7 cm ↔ 7.7 cm

**No.20**

3 min	
1	(107)
2	(509)

↓ 7.7 cm ↔ 9.1 cm

**No.13**

8 min	
1	(513)
2	(208)

↓ 27.9 cm ↔ 12.5 cm

**No.16**

6 min	
1	(070)
2	(007)
3	(107)
4	(070)

↓ 16.8 cm ↔ 18.3 cm

**No.17**

2 min	
1	(107)
2	(070)
3	(007)

↓ 4.5 cm ↔ 19.1 cm

**No.14**

4 min	
1	(030)
2	(323)

↓ 18.1 cm ↔ 18.0 cm

**No.18**

2 min	
1	(007)

↓ 22.5 cm ↔ 5.4 cm

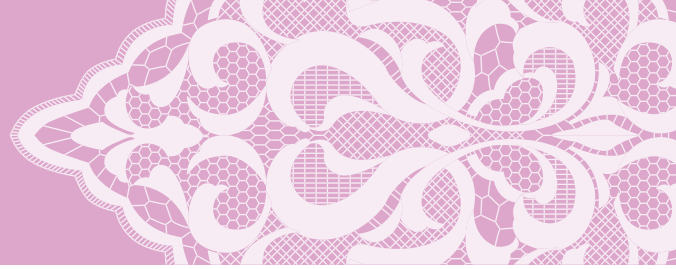

◁ Greek alphabet patterns

◁ Buchstabenmuster des griechischen Alphabets

◁ Motifs alphabet grec



◁ Griechse alfabetpatronen

◁ Disegni alfabeto greco

◁ Costuras de caracteres alfabéticos griegos



No.1

5 min
1 (209)
2 (513)
3 (405)
↓ 5.6 cm ↔ 5.7 cm



No.6

5 min
1 (209)
2 (513)
3 (405)
↓ 5.4 cm ↔ 4.8 cm



No.11

4 min
1 (209)
2 (513)
3 (405)
↓ 5.6 cm ↔ 5.4 cm



No.2

7 min
1 (209)
2 (513)
3 (405)
↓ 5.4 cm ↔ 5.1 cm



No.7

6 min
1 (209)
2 (513)
3 (405)
↓ 5.4 cm ↔ 5.6 cm



No.12

8 min
1 (209)
2 (513)
3 (405)
↓ 5.4 cm ↔ 6.8 cm



No.3

4 min
1 (209)
2 (513)
3 (405)
↓ 5.4 cm ↔ 4.8 cm



No.8

7 min
1 (209)
2 (513)
3 (405)
↓ 5.7 cm ↔ 5.3 cm



No.13

5 min
1 (209)
2 (513)
3 (405)
↓ 5.6 cm ↔ 5.6 cm



No.4

5 min
1 (209)
2 (513)
3 (405)
↓ 5.6 cm ↔ 5.0 cm

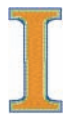

No.9

3 min
1 (209)
2 (513)
3 (405)
↓ 5.4 cm ↔ 2.7 cm



No.14

7 min
1 (209)
2 (513)
3 (405)
↓ 5.4 cm ↔ 4.9 cm



No.5

5 min
1 (209)
2 (513)
3 (405)
↓ 5.4 cm ↔ 5.0 cm



No.10

6 min
1 (209)
2 (513)
3 (405)
↓ 5.4 cm ↔ 5.7 cm



No.15

5 min
1 (209)
2 (513)
3 (405)
↓ 5.7 cm ↔ 5.3 cm



No.16

6 min	
1	Orange (209)
2	Green (513)
3	Blue (405)
↕ 5.4 cm ↔ 5.9 cm	



No.19

4 min	
1	Orange (209)
2	Green (513)
3	Blue (405)
↕ 5.4 cm ↔ 4.8 cm	



No.22

6 min	
1	Orange (209)
2	Green (513)
3	Blue (405)
↕ 5.4 cm ↔ 5.7 cm	



No.17

5 min	
1	Orange (209)
2	Green (513)
3	Blue (405)
↕ 5.4 cm ↔ 4.4 cm	



No.20

5 min	
1	Orange (209)
2	Green (513)
3	Blue (405)
↕ 5.4 cm ↔ 5.6 cm	



No.23

6 min	
1	Orange (209)
2	Green (513)
3	Blue (405)
↕ 5.4 cm ↔ 6.2 cm	



No.18

5 min	
1	Orange (209)
2	Green (513)
3	Blue (405)
↕ 5.4 cm ↔ 4.9 cm	



No.21

7 min	
1	Orange (209)
2	Green (513)
3	Blue (405)
↕ 5.4 cm ↔ 5.6 cm	



No.24

7 min	
1	Orange (209)
2	Green (513)
3	Blue (405)
↕ 5.6 cm ↔ 5.3 cm	



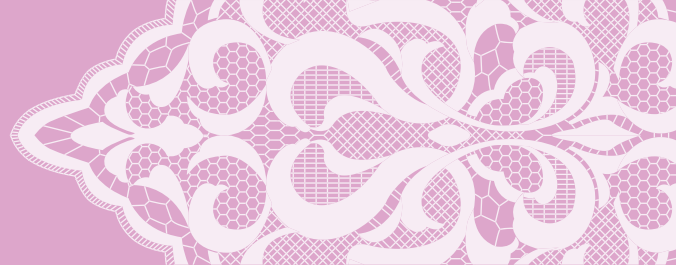

Floral alphabet patterns  
Bloemletterpatronen

Blumenalphabet  
Alfabeto floreale

Motifs alphabet floral  
Patrones alfabéticas en motivo floral

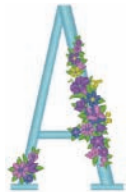

**No.1 15 min**

1	(017)
2	(513)
3	(810)
4	(070)
5	(612)
6	(205)

↓ 12.6 cm ↔ 7.9 cm



**No.6 20 min**

1	(017)
2	(513)
3	(070)
4	(810)
5	(205)
6	(612)

↓ 12.6 cm ↔ 8.1 cm

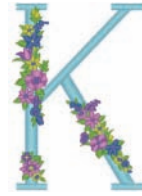

**No.11 19 min**

1	(017)
2	(513)
3	(810)
4	(612)
5	(205)
6	(070)

↓ 12.6 cm ↔ 8.8 cm

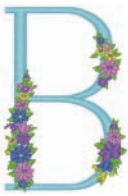

**No.2 18 min**

1	(017)
2	(513)
3	(810)
4	(205)
5	(070)
6	(612)

↓ 12.7 cm ↔ 8.3 cm



**No.7 17 min**

1	(017)
2	(513)
3	(205)
4	(612)
5	(070)
6	(810)

↓ 12.7 cm ↔ 8.4 cm



**No.12 13 min**

1	(017)
2	(513)
3	(810)
4	(205)
5	(612)
6	(070)

↓ 12.6 cm ↔ 7.7 cm



**No.3 15 min**

1	(017)
2	(513)
3	(810)
4	(205)
5	(612)
6	(070)

↓ 12.6 cm ↔ 8.2 cm



**No.8 18 min**

1	(017)
2	(513)
3	(612)
4	(810)
5	(205)
6	(070)

↓ 12.6 cm ↔ 9.0 cm

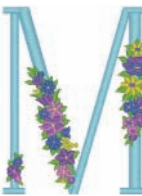

**No.13 25 min**

1	(017)
2	(513)
3	(205)
4	(612)
5	(810)
6	(070)

↓ 12.6 cm ↔ 10.4 cm



**No.4 17 min**

1	(017)
2	(513)
3	(205)
4	(810)
5	(612)
6	(070)

↓ 12.7 cm ↔ 8.6 cm



**No.9 10 min**

1	(017)
2	(513)
3	(612)
4	(810)
5	(070)
6	(205)

↓ 12.6 cm ↔ 2.6 cm

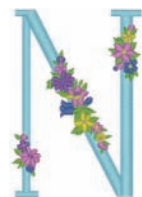

**No.14 17 min**

1	(017)
2	(513)
3	(070)
4	(810)
5	(612)
6	(205)

↓ 12.6 cm ↔ 8.7 cm



**No.5 21 min**

1	(017)
2	(513)
3	(810)
4	(070)
5	(612)
6	(205)

↓ 12.6 cm ↔ 8.6 cm



**No.10 10 min**

1	(017)
2	(513)
3	(612)
4	(810)
5	(070)
6	(205)

↓ 12.6 cm ↔ 5.0 cm



**No.15 16 min**

1	(017)
2	(513)
3	(612)
4	(810)
5	(070)
6	(205)

↓ 12.5 cm ↔ 9.5 cm

Embroidery Pattern Color Change Table  
 Stickmuster-Farbtabelle  
 Tableau de changement de couleur des motifs de broderie  
 Kleurwijzigingstabel voor de borduurpatronen  
 Tabella di cambiamento colori degli schemi di ricamo  
 Tabla de cambio de color para patrones de bordado



**No.16** **13 min**

1	(017)
2	(513)
3	(810)
4	(070)
5	(205)
6	(612)

↕ 12.6 cm ↔ 7.3 cm



**No.20** **14 min**

1	(017)
2	(513)
3	(810)
4	(205)
5	(612)
6	(070)

↕ 12.6 cm ↔ 7.0 cm

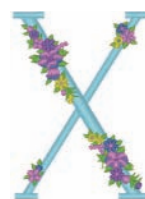

**No.24** **17 min**

1	(017)
2	(513)
3	(070)
4	(810)
5	(205)
6	(612)

↕ 12.6 cm ↔ 9.2 cm



**No.17** **21 min**

1	(017)
2	(513)
3	(810)
4	(612)
5	(205)
6	(070)

↕ 12.9 cm ↔ 9.5 cm

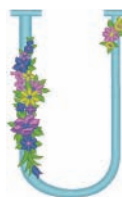

**No.21** **13 min**

1	(017)
2	(513)
3	(810)
4	(612)
5	(070)
6	(205)

↕ 12.6 cm ↔ 8.0 cm



**No.25** **14 min**

1	(017)
2	(513)
3	(070)
4	(810)
5	(612)
6	(205)

↕ 12.6 cm ↔ 8.5 cm



**No.18** **18 min**

1	(017)
2	(513)
3	(612)
4	(070)
5	(810)
6	(205)

↕ 12.6 cm ↔ 8.3 cm



**No.22** **13 min**

1	(017)
2	(513)
3	(810)
4	(070)
5	(612)
6	(205)

↕ 12.6 cm ↔ 7.8 cm



**No.26** **15 min**

1	(017)
2	(513)
3	(810)
4	(205)
5	(612)
6	(070)

↕ 12.6 cm ↔ 7.0 cm



**No.19** **15 min**

1	(017)
2	(513)
3	(810)
4	(612)
5	(205)
6	(070)

↕ 12.6 cm ↔ 7.0 cm



**No.23** **24 min**

1	(017)
2	(513)
3	(612)
4	(810)
5	(070)
6	(205)

↕ 12.6 cm ↔ 11.9 cm



**No.27** **6 min**

1	(017)
---	-------

↕ 8.0 cm ↔ 5.9 cm



**No.30** **7 min**

1	(017)
---	-------

↕ 12.6 cm ↔ 6.1 cm



**No.33** **10 min**

1	(017)
---	-------

↕ 12.6 cm ↔ 8.6 cm



**No.36** **5 min**

1	(017)
---	-------

↕ 15.8 cm ↔ 4.0 cm



**No.28** **7 min**

1	(017)
---	-------

↕ 12.6 cm ↔ 6.1 cm



**No.31** **6 min**

1	(017)
---	-------

↕ 8.3 cm ↔ 5.7 cm



**No.34** **7 min**

1	(017)
---	-------

↕ 12.6 cm ↔ 6.3 cm



**No.37** **7 min**

1	(017)
---	-------

↕ 12.6 cm ↔ 6.6 cm



**No.29** **4 min**

1	(017)
---	-------

↕ 8.3 cm ↔ 5.6 cm



**No.32** **5 min**

1	(017)
---	-------

↕ 12.6 cm ↔ 5.5 cm



**No.35** **3 min**

1	(017)
---	-------

↕ 11.0 cm ↔ 1.9 cm



**No.38** **4 min**

1	(017)
---	-------

↕ 12.6 cm ↔ 2.0 cm

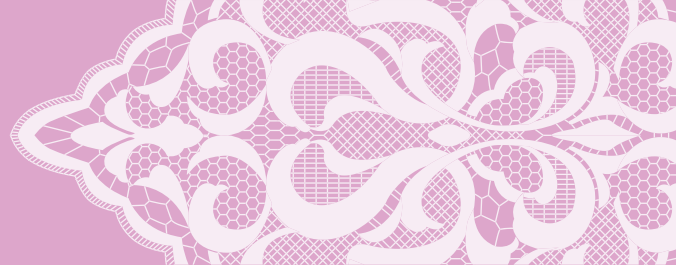

**No.39** **9 min**

1  (017)

↕ 8.0 cm ↔ 9.0 cm

**No.43** **8 min**

1  (017)

↕ 12.6 cm ↔ 6.9 cm

**No.47** **6 min**

1  (017)

↕ 8.0 cm ↔ 6.5 cm

**No.51** **7 min**

1  (017)

↕ 12.6 cm ↔ 8.5 cm

**No.40** **6 min**

1  (017)

↕ 8.0 cm ↔ 6.5 cm

**No.44** **4 min**

1  (017)

↕ 8.1 cm ↔ 5.4 cm

**No.48** **4 min**

1  (017)

↕ 8.0 cm ↔ 5.7 cm

**No.52** **5 min**

1  (017)

↕ 8.0 cm ↔ 5.2 cm

**No.41** **6 min**

1  (017)

↕ 8.2 cm ↔ 5.6 cm

**No.45** **6 min**

1  (017)

↕ 8.1 cm ↔ 5.0 cm

**No.49** **7 min**

1  (017)

↕ 8.0 cm ↔ 8.2 cm

**No.42** **8 min**

1  (017)

↕ 12.6 cm ↔ 6.9 cm

**No.46** **5 min**

1  (017)

↕ 12.7 cm ↔ 5.2 cm

**No.50** **4 min**

1  (017)

↕ 8.0 cm ↔ 6.0 cm

**No.53** **5 min**

1  (513)

2  (612)

3  (810)

4  (070)

5  (205)

↕ 9.5 cm ↔ 2.5 cm

**No.56** **1 min**

1  (513)

2  (810)

3  (070)

4  (612)

↕ 2.6 cm ↔ 2.4 cm

**No.57** **1 min**

1  (513)

2  (070)

3  (810)

↕ 1.8 cm ↔ 1.3 cm

**No.59** **8 min**

1  (513)

2  (070)

3  (810)

4  (612)

5  (205)

↕ 7.6 cm ↔ 9.6 cm

**No.54** **3 min**

1  (513)

2  (810)

3  (612)

4  (205)

5  (070)

↕ 4.8 cm ↔ 2.1 cm

**No.58** **40 min**

1  (513)

2  (070)

3  (124)

4  (086)

5  (205)

6  (513)

7  (070)

8  (124)

9  (086)

10  (205)

↕ 23.9 cm ↔ 19.9 cm

**No.60** **7 min**

1  (513)

2  (070)

3  (810)

4  (612)

5  (205)

↕ 3.8 cm ↔ 10.9 cm

**No.55** **1 min**

1  (513)

2  (810)

3  (205)

4  (612)

↕ 2.6 cm ↔ 1.7 cm

**No.61** **7 min**

1  (513)

2  (070)

3  (810)

4  (612)

5  (205)

↕ 4.2 cm ↔ 8.0 cm



Utility embroidery patterns

Nutzstich-Stickmuster

Motifs de broderie courants



Borduurnaai patronen

Disegni da ricamo utili

Patrones de bordado de utilidad

1 min 1 (900)		No.9	No.18	No.27	No.36	No.45	No.54	No.63
	↕ 3.2 cm ↔ 0.0 cm	↕ 3.6 cm ↔ 0.7 cm	↕ 2.7 cm ↔ 0.7 cm	↕ 3.2 cm ↔ 1.2 cm	↕ 3.4 cm ↔ 0.8 cm	↕ 4.8 cm ↔ 0.7 cm	↕ 3.9 cm ↔ 1.2 cm	↕ 4.2 cm ↔ 1.4 cm
No.1								
	↕ 3.0 cm ↔ 0.3 cm	↕ 3.4 cm ↔ 0.7 cm	↕ 3.9 cm ↔ 1.2 cm	↕ 3.1 cm ↔ 1.2 cm	↕ 3.9 cm ↔ 0.8 cm	↕ 4.8 cm ↔ 0.8 cm	↕ 5.1 cm ↔ 1.2 cm	↕ 4.3 cm ↔ 1.5 cm
No.2								
	↕ 3.5 cm ↔ 0.4 cm	↕ 3.6 cm ↔ 0.7 cm	↕ 3.8 cm ↔ 0.8 cm	↕ 4.2 cm ↔ 1.2 cm	↕ 4.7 cm ↔ 1.2 cm	↕ 8.2 cm ↔ 1.9 cm	↕ 3.2 cm ↔ 0.7 cm	↕ 5.5 cm ↔ 1.3 cm
No.3								
	↕ 3.3 cm ↔ 0.7 cm	↕ 3.3 cm ↔ 0.7 cm	↕ 3.8 cm ↔ 0.8 cm	↕ 4.2 cm ↔ 1.3 cm	↕ 5.5 cm ↔ 1.2 cm	↕ 5.6 cm ↔ 1.2 cm	↕ 3.7 cm ↔ 1.2 cm	↕ 4.8 cm ↔ 1.5 cm
No.4								
	↕ 3.4 cm ↔ 0.7 cm	↕ 3.9 cm ↔ 1.2 cm	↕ 3.2 cm ↔ 0.8 cm	↕ 3.4 cm ↔ 1.0 cm	↕ 5.7 cm ↔ 1.1 cm	↕ 3.4 cm ↔ 1.2 cm	↕ 5.8 cm ↔ 1.2 cm	↕ 7.2 cm ↔ 1.7 cm
No.5								
	↕ 3.4 cm ↔ 0.7 cm	↕ 3.0 cm ↔ 0.9 cm	↕ 3.2 cm ↔ 1.2 cm	↕ 3.3 cm ↔ 0.9 cm	↕ 4.8 cm ↔ 1.2 cm	↕ 3.5 cm ↔ 1.2 cm	↕ 3.5 cm ↔ 1.6 cm	↕ 5.1 cm ↔ 1.4 cm
No.6								
	↕ 3.5 cm ↔ 0.6 cm	↕ 3.7 cm ↔ 0.9 cm	↕ 3.4 cm ↔ 0.7 cm	↕ 3.5 cm ↔ 0.8 cm	↕ 4.5 cm ↔ 0.7 cm	↕ 3.8 cm ↔ 1.2 cm	↕ 3.3 cm ↔ 0.9 cm	↕ 4.6 cm ↔ 4.6 cm
No.7								
	↕ 3.3 cm ↔ 0.5 cm	↕ 3.2 cm ↔ 1.2 cm	↕ 6.6 cm ↔ 1.2 cm	↕ 3.2 cm ↔ 0.5 cm	↕ 4.4 cm ↔ 0.7 cm	↕ 3.4 cm ↔ 1.2 cm	↕ 4.8 cm ↔ 2.0 cm	↕ 3.6 cm ↔ 1.2 cm
No.8								
	↕ 3.8 cm ↔ 0.3 cm	↕ 3.4 cm ↔ 1.2 cm	↕ 3.6 cm ↔ 0.9 cm	↕ 3.4 cm ↔ 0.4 cm	↕ 4.0 cm ↔ 0.7 cm	↕ 3.3 cm ↔ 0.7 cm	↕ 4.8 cm ↔ 2.2 cm	↕ 2.8 cm ↔ 4.0 cm

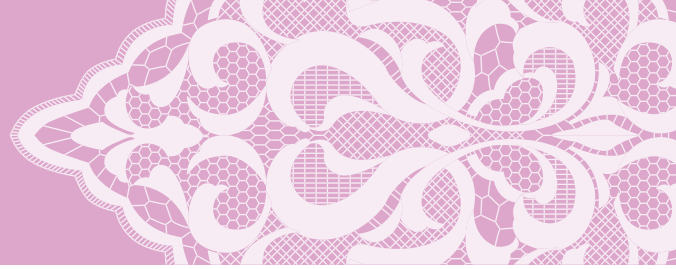

**1 min**  
1 (900)

**No.72**

↕ 3.4 cm ↔ 4.0 cm

**No.73**

↕ 4.6 cm ↔ 8.0 cm

**No.74**

↕ 6.5 cm ↔ 4.0 cm

**No.75**

↕ 7.7 cm ↔ 2.0 cm

**No.76**

↕ 8.6 cm ↔ 4.2 cm

**No.77**

↕ 5.0 cm ↔ 4.0 cm

**No.78**

↕ 8.4 cm ↔ 4.2 cm

**No.79**

↕ 5.0 cm ↔ 4.0 cm

**No.80**

↕ 3.1 cm ↔ 0.9 cm

**No.81**

↕ 4.9 cm ↔ 0.9 cm

**No.82**

↕ 5.7 cm ↔ 0.9 cm

**No.83**

↕ 3.6 cm ↔ 0.9 cm

**No.84**

↕ 3.2 cm ↔ 1.0 cm

**No.85**

↕ 3.7 cm ↔ 2.0 cm

**No.86**

↕ 3.4 cm ↔ 2.0 cm

**No.87**

↕ 3.6 cm ↔ 2.0 cm

**No.88**

↕ 3.8 cm ↔ 2.1 cm

**No.89**

↕ 3.6 cm ↔ 2.0 cm

**No.90**

↕ 4.0 cm ↔ 2.0 cm

**No.91**

↕ 4.5 cm ↔ 1.5 cm

**No.92**

↕ 5.7 cm ↔ 2.5 cm

**No.93**

↕ 3.0 cm ↔ 1.0 cm

**No.94**

↕ 3.6 cm ↔ 1.8 cm

**No.95**

↕ 4.2 cm ↔ 0.9 cm

**No.96**

↕ 3.8 cm ↔ 0.8 cm

**No.97**

↕ 3.2 cm ↔ 0.7 cm

**No.98**

↕ 3.0 cm ↔ 1.0 cm

**No.99**

↕ 2.8 cm ↔ 1.1 cm

**No.100**

↕ 4.2 cm ↔ 0.9 cm

**No.101**

↕ 3.9 cm ↔ 2.0 cm

**No.102**

↕ 6.3 cm ↔ 1.8 cm

**No.103**

↕ 4.9 cm ↔ 1.8 cm

**No.104**

↕ 3.9 cm ↔ 1.3 cm

**No.105**

↕ 4.9 cm ↔ 1.0 cm

**No.106**

↕ 3.6 cm ↔ 1.0 cm

**No.107**

↕ 5.3 cm ↔ 1.2 cm

**No.108**

↕ 3.8 cm ↔ 0.9 cm

**No.109**

↕ 3.6 cm ↔ 1.3 cm

**No.110**

↕ 3.0 cm ↔ 1.2 cm

**No.111**

↕ 3.2 cm ↔ 0.9 cm

**No.112**

↕ 3.5 cm ↔ 1.2 cm

**No.113**

↕ 4.5 cm ↔ 1.0 cm

**No.114**

↕ 3.0 cm ↔ 0.9 cm

**No.115**

↕ 3.5 cm ↔ 0.7 cm

**No.116**

↕ 6.0 cm ↔ 0.9 cm

**No.117**

↕ 4.2 cm ↔ 0.7 cm

**No.118**

↕ 4.0 cm ↔ 0.9 cm

**No.119**

↕ 3.8 cm ↔ 0.9 cm

**No.120**

↕ 3.6 cm ↔ 0.9 cm

**No.121**

↕ 3.4 cm ↔ 0.7 cm

**No.122**

↕ 3.4 cm ↔ 0.6 cm

**No.123**

↕ 4.0 cm ↔ 0.7 cm

**No.124**

↕ 3.4 cm ↔ 0.7 cm

**No.125**

↕ 3.4 cm ↔ 0.7 cm

**No.126**

↕ 5.0 cm ↔ 0.6 cm

**No.127**

↕ 3.0 cm ↔ 0.7 cm

**No.128**

↕ 3.4 cm ↔ 0.7 cm

**No.129**

↕ 2.6 cm ↔ 0.7 cm

**No.130**

↕ 3.4 cm ↔ 0.7 cm

**No.131**

↕ 4.2 cm ↔ 0.7 cm

**No.132**

↕ 3.7 cm ↔ 0.8 cm

**No.133**

↕ 3.1 cm ↔ 0.7 cm

**No.134**

↕ 3.0 cm ↔ 0.3 cm

**No.135**

↕ 3.2 cm ↔ 0.4 cm

**No.136**

↕ 3.0 cm ↔ 0.5 cm

**No.137**

↕ 3.2 cm ↔ 0.8 cm

**No.138**

↕ 4.2 cm ↔ 1.2 cm

**No.139**

↕ 3.0 cm ↔ 0.9 cm

**No.140**

↕ 3.0 cm ↔ 0.6 cm

**No.141**

↕ 3.2 cm ↔ 0.6 cm

**No.142**

↕ 5.2 cm ↔ 1.0 cm

**No.143**

↕ 3.0 cm ↔ 0.6 cm

**No.144**

↕ 3.2 cm ↔ 0.6 cm

**No.145**

↕ 3.6 cm ↔ 0.6 cm

**No.146**

↕ 3.6 cm ↔ 1.0 cm

**No.147**

↕ 3.2 cm ↔ 0.8 cm

**No.148**

↕ 3.2 cm ↔ 0.8 cm

**No.149**

↕ 3.6 cm ↔ 0.6 cm

**No.150**

↕ 3.0 cm ↔ 1.0 cm

**Embroidery Pattern Color Change Table**  
**Stickmuster-Farbtabelle**  
**Tableau de changement de couleur des motifs de broderie**  
**Kleurwijzigingstabel voor de borduurpatronen**  
**Tabella di cambiamento colori degli schemi di ricamo**  
**Tabla de cambio de color para patrones de bordado**

Patterns for bobbin work

Stickmuster für Bobbin Work

Motifs pour le travail à la canette

Patronen voor werken met de spoel

Disegni per ricamo con spolina

Patrones para efectos decorativos con bobinas

**Note :** Embroidery patterns for bobbin work are reversed when they have been sewn.

**Hinweis :** Stickmuster für Bobbin Work werden nach dem Nähen umgedreht.

**Remarque :** Les motifs de broderie pour le travail à la canette sont inversés lorsqu'ils sont cousus.

**Opmerking :** Borduurpatronen voor het werken met de spoel worden omgekeerd nadat deze zijn gemaakt.

**Nota :** I motivi per il ricamo con spolina vengono capovolti durante la cucitura.

**Nota :** Los patrones de bordado para efectos decorativos con bobinas se invierten una vez cosidos.



**No.146**



<b>4 min</b>
1 <span style="color: red;">■</span> (030)
↕ 22.4 cm ↔ 19.9 cm
 4.5 m (3.9 m + 0.6 m)

Total length of thread needed to sew the pattern (to sew the pattern + to tie ends)

Erforderliche Gesamtfadenlänge zum Nähen des Musters (Muster nähen + Enden verknoten)

Longueur totale de fil nécessaire pour coudre le motif (coudre le motif + nouer les extrémités)

Totale lengte van de draad die nodig is om het patroon te maken (patroon naaien + uiteinden vastknopen)

Lunghezza totale del filo necessaria per la cucitura del motivo (cucire il motivo + annodare le estremità)

Longitud total de hilo necesario para coser el patrón (coser el patrón + atar los extremos)

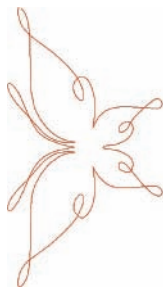

**No.147**



<b>1 min</b>
1 <span style="color: red;">■</span> (030)
↕ 17.5 cm ↔ 9.7 cm
 1.5 m (0.9 m + 0.6 m)



**No.150**



<b>2 min</b>
1 <span style="color: red;">■</span> (030)
↕ 19.6 cm ↔ 9.8 cm
 2.3 m (1.7 m + 0.6 m)



**No.148**



<b>1 min</b>
1 <span style="color: green;">■</span> (509)
↕ 12.4 cm ↔ 12.7 cm
 1.6 m (1.0 m + 0.6 m)



**No.151**



<b>1 min</b>
1 <span style="color: blue;">■</span> (405)
↕ 17.5 cm ↔ 10.4 cm
 1.8 m (1.2 m + 0.6 m)



**No.149**



<b>3 min</b>
1 <span style="color: blue;">■</span> (405)
↕ 16.5 cm ↔ 12.5 cm
 2.8 m (2.2 m + 0.6 m)

Refer to the operation manual for the sewing machine for details on how to embroider bobbin work patterns.

Weitere Hinweise zum Sticken von Bobbin Work finden Sie in der Bedienungsanleitung der Nähmaschine.

Reportez-vous au Manuel d'instructions de la machine à coudre pour plus de détails sur la broderie des motifs pour le travail à la canette.

Zie de bedieningshandleiding bij de naaimachine voor bijzonderheden over het borduren met de spoel.

Fare riferimento al manuale d'istruzione della macchina da cucire per i dettagli su come ricamare i disegni per il ricamo con spolina.

Para obtener más información sobre cómo bordar patrones para efectos decorativos con bobinas, consulte el manual de instrucciones de la máquina de coser.



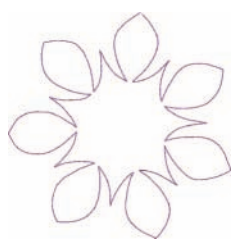
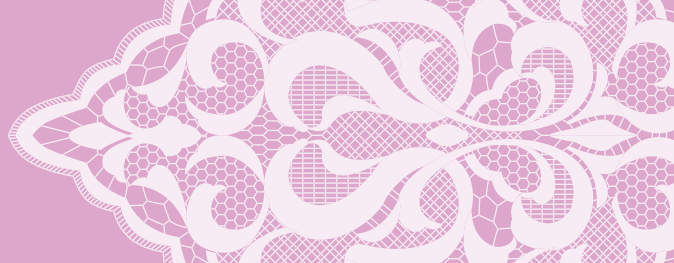

No.152

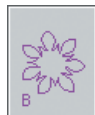

1 min	
1	(620)
↕13.6 cm ↔ 13.3 cm	
 1.6 m (1.0 m + 0.6 m)	

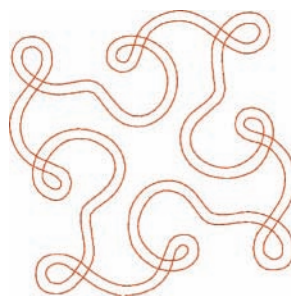

No.156



2 min	
1	(030)
↕12.6 cm ↔ 12.6 cm	
 2.4 m (1.8 m + 0.6 m)	

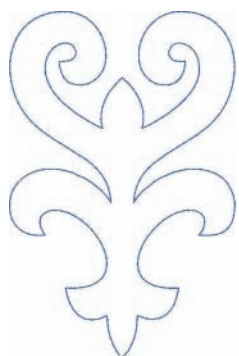

No.153



1 min	
1	(405)
↕15.4 cm ↔ 10.0 cm	
 1.6 m (1.0 m + 0.6 m)	



No.157



3 min	
1	(328)
↕22.4 cm ↔ 17.7 cm	
 3.5 m (2.9 m + 0.6 m)	



No.154



1 min	
1	(509)
↕6.3 cm ↔ 7.5 cm	
 1.1 m (0.5 m + 0.6 m)	



No.158



2 min	
1	(542)
↕12.4 cm ↔ 13.6 cm	
 2.7 m (2.1 m + 0.6 m)	



No.155



1 min	
1	(405)
↕7.5 cm ↔ 6.8 cm	
 1.0 m (0.4 m + 0.6 m)	



No.159



2 min	
1	(209)
↕8.2 cm ↔ 11.8 cm	
 2.2 m (1.6 m + 0.6 m)	

# Examples of Combinations Exemples de combinaisons Esempi di combinazioni

# Kombinationsbeispiele Voorbeelden van combinaties Ejemplos de combinaciones

Combine various embroidery patterns, as shown below, to enhance your embroidering enjoyment.  
 Wenn Sie verschiedene Stickmuster wie unten dargestellt miteinander kombinieren, macht das Stickten noch mehr Spaß.  
 Combinez plusieurs motifs de broderie comme indiqué ci-dessous, pour un plaisir de broderie garanti.  
 Zoals hieronder aangegeven kunt u diverse borduurpatronen combineren. Zo borduurt u met nog meer plezier.  
 Combinare vari disegni da ricamo, come indicato di seguito, per rendere il ricamo ancora più divertente.  
 Combine distintos patrones de bordado, como se muestra a continuación, para un mayor deleite al bordar.



**Positioning symbols:** These symbols indicate how embroidery patterns have been flipped or rotated to create the combined pattern.

**Positionierungssymbole:** Diese Symbole zeigen an, wie Stickmuster für die Musterkombination gespiegelt oder gedreht wurden.

**Symboles de positionnement :** Ces symboles indiquent la manière dont les motifs de broderie ont été inversés ou tournés pour créer le motif combiné.

**Plaatsingssymbolen:** deze symbolen geven aan hoe borduurpatronen zijn gedraaid rond een as of middelpunt om het gecombineerde patroon te creëren.

**Simboli di posizionamento:** questi simboli indicano la modalità di ribaltamento o rotazione dei disegni da ricamo per creare il disegno combinato.

**Símbolos de colocación:** estos símbolos indican cómo se han invertido o girado los patrones de bordado para crear el patrón combinado.

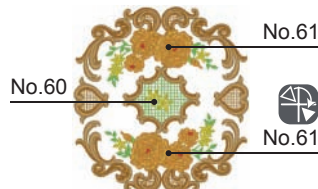
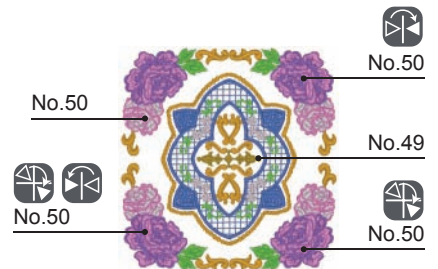
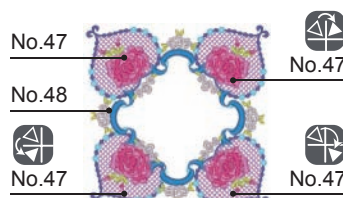
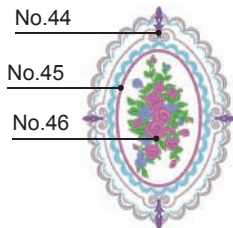
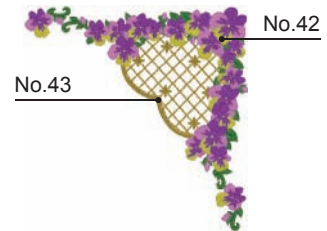
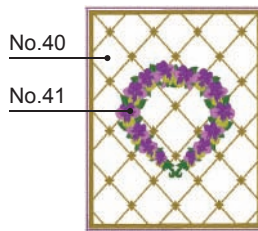
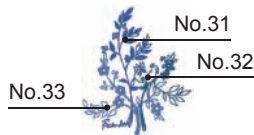
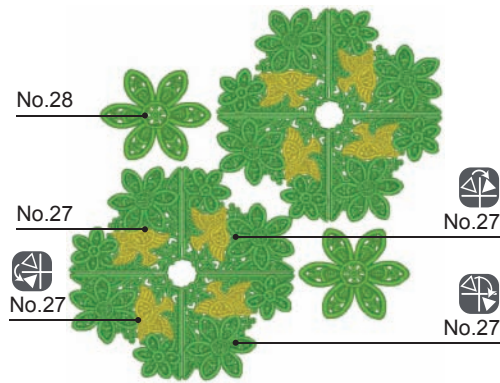
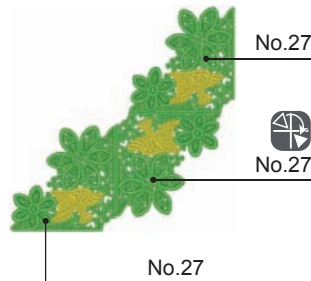

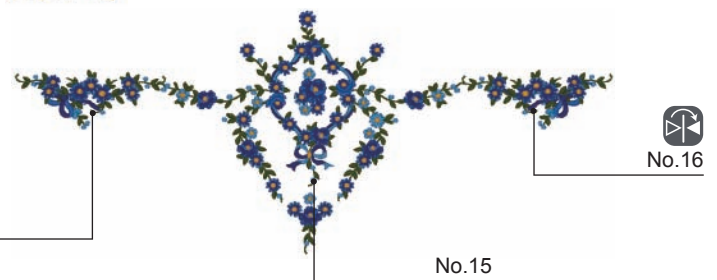
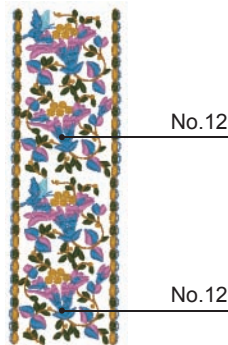
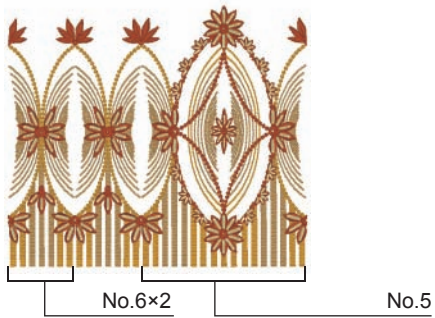
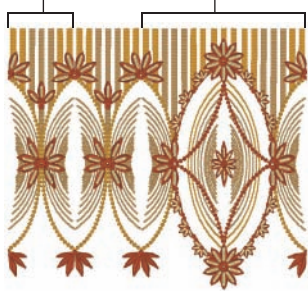
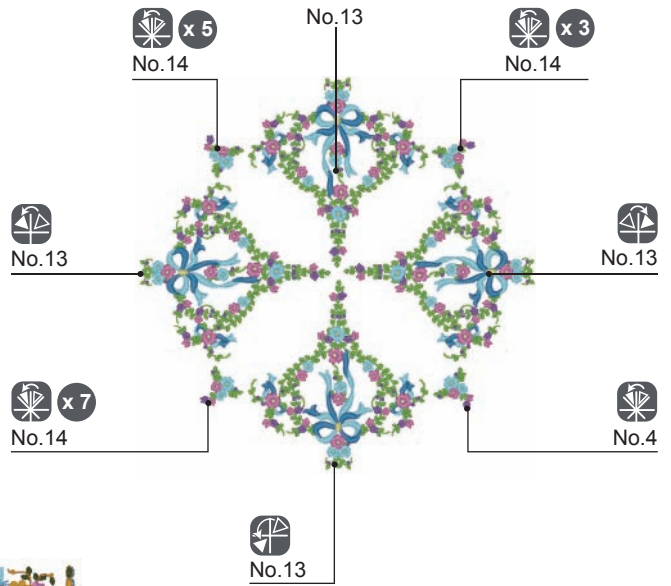
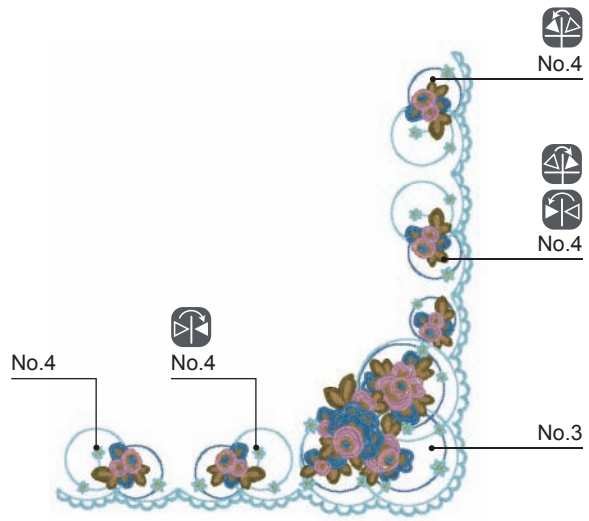
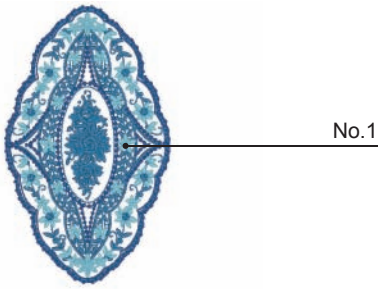
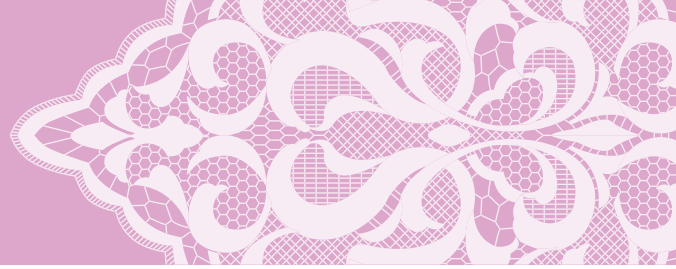





**Positioning symbols:** These symbols indicate how embroidery patterns have been flipped or rotated to create the combined pattern.

**Positionierungssymbole:** Diese Symbole zeigen an, wie Stickmuster für die Musterkombination gespiegelt oder gedreht wurden.

**Symboles de positionnement :** Ces symboles indiquent la manière dont les motifs de broderie ont été inversés ou tournés pour créer le motif combiné.

**Plaatsingssymbolen:** deze symbolen geven aan hoe borduurpatronen zijn gedraaid rond een as of middelpunt om het gecombineerde patroon te creëren.

**Simboli di posizionamento:** questi simboli indicano la modalità di ribaltamento o rotazione dei disegni da ricamo per creare il disegno combinato.

**Símbolos de colocación:** estos símbolos indican cómo se han invertido o girado los patrones de bordado para crear el patrón combinado.

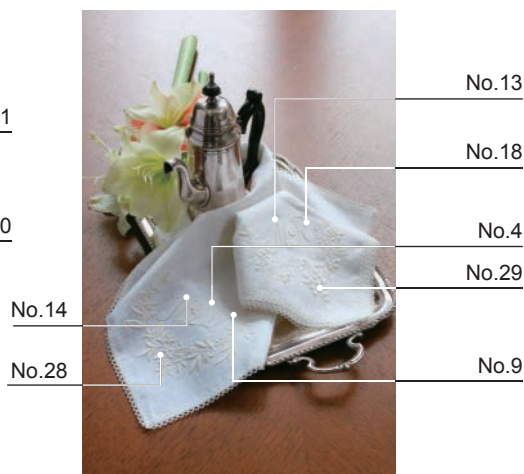
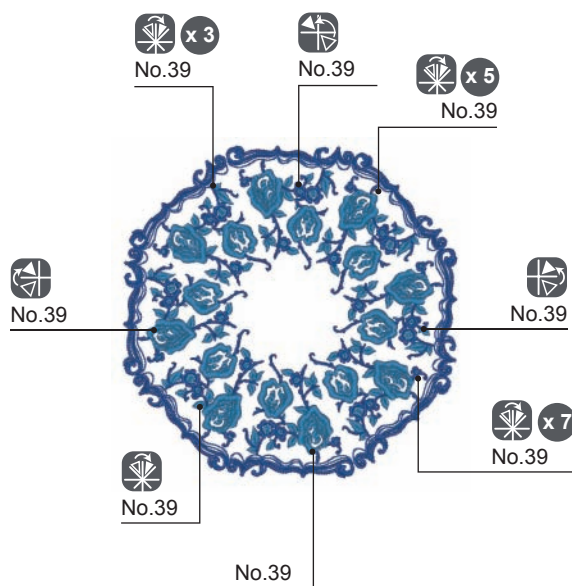
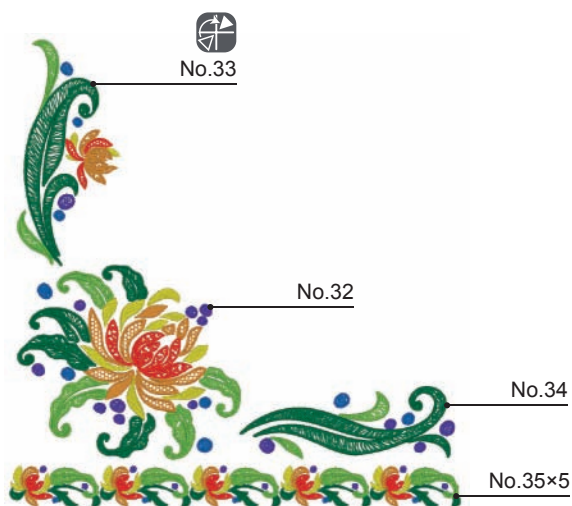
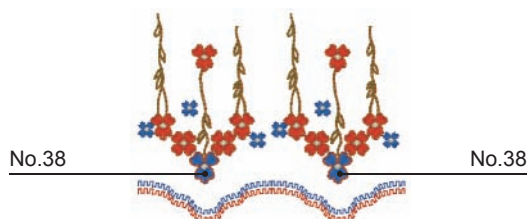
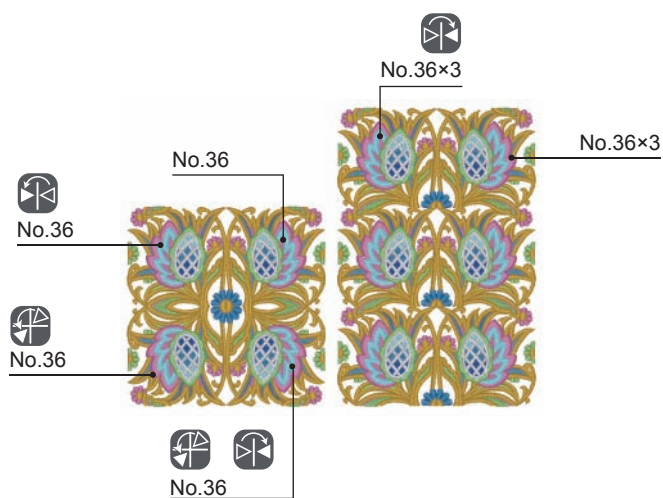
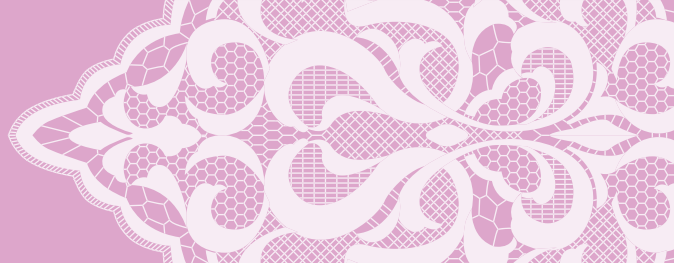

**Positioning symbols:** These symbols indicate how embroidery patterns have been flipped or rotated to create the combined pattern.

**Positionierungssymbole:** Diese Symbole zeigen an, wie Stickmuster für die Musterkombination gespiegelt oder gedreht wurden.

**Symboles de positionnement :** Ces symboles indiquent la manière dont les motifs de broderie ont été inversés ou tournés pour créer le motif combiné.

**Plaatsingssymbolen:** deze symbolen geven aan hoe borduurpatronen zijn gedraaid rond een as of middelpunt om het gecombineerde patroon te creëren.

**Simboli di posizionamento:** questi simboli indicano la modalità di ribaltamento o rotazione dei disegni da ricamo per creare il disegno combinato.

**Símbolos de colocación:** estos símbolos indican cómo se han invertido o girado los patrones de bordado para crear el patrón combinado.



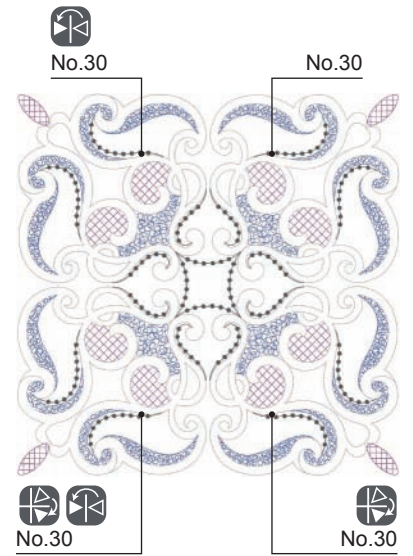
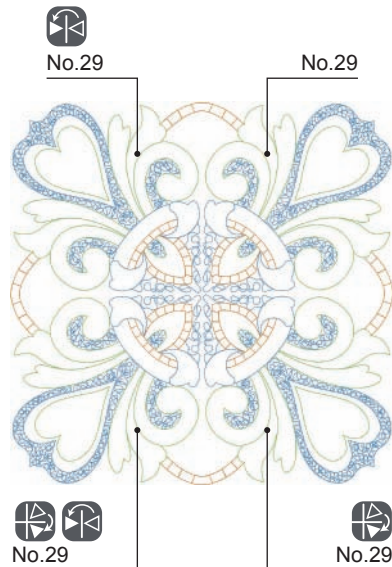
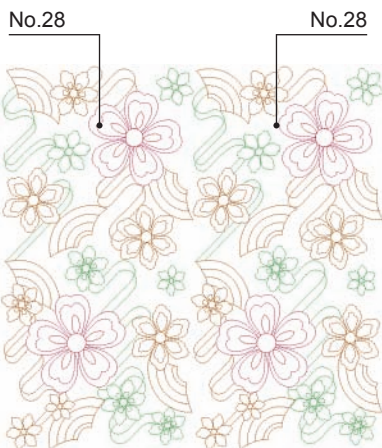
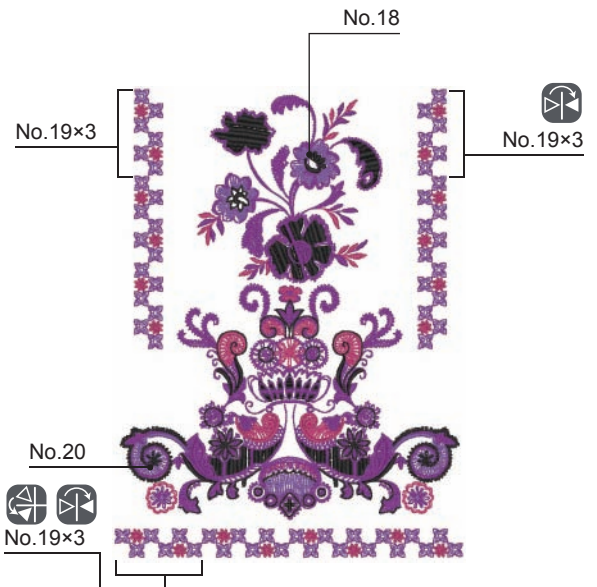
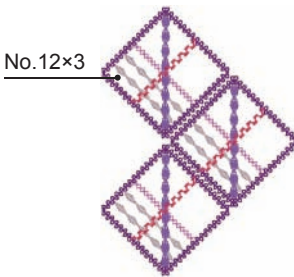
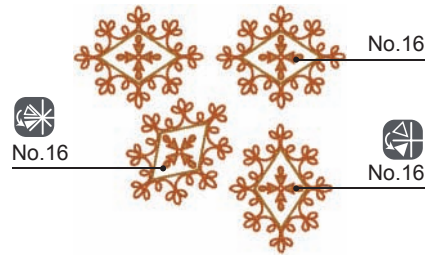
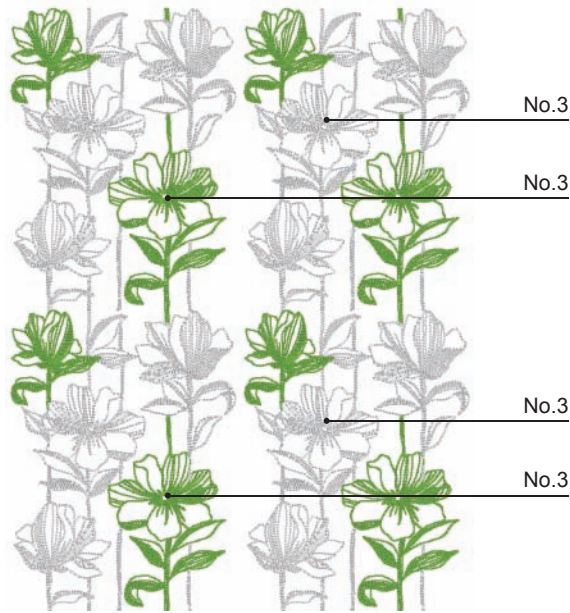



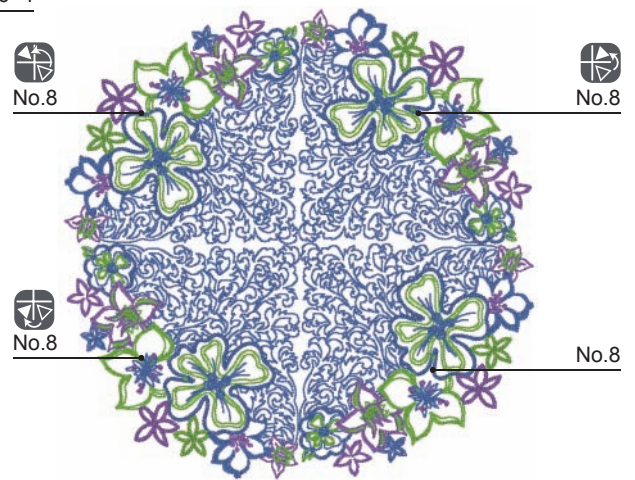
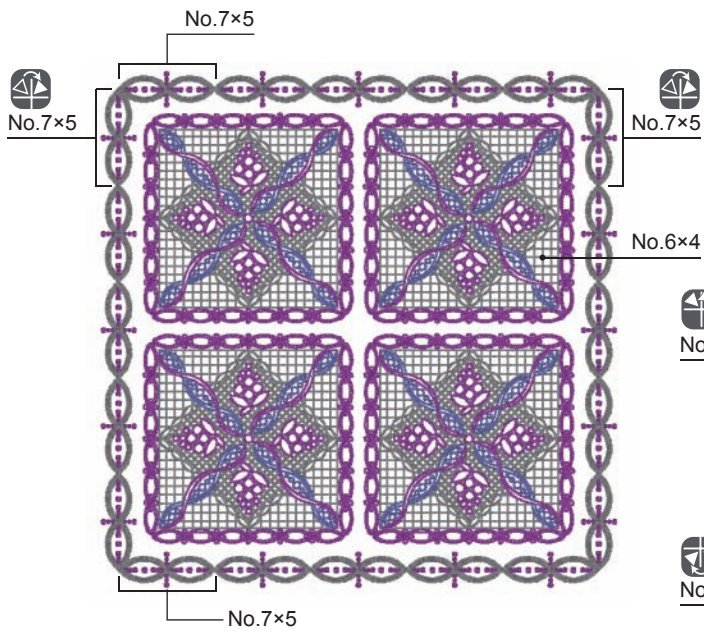
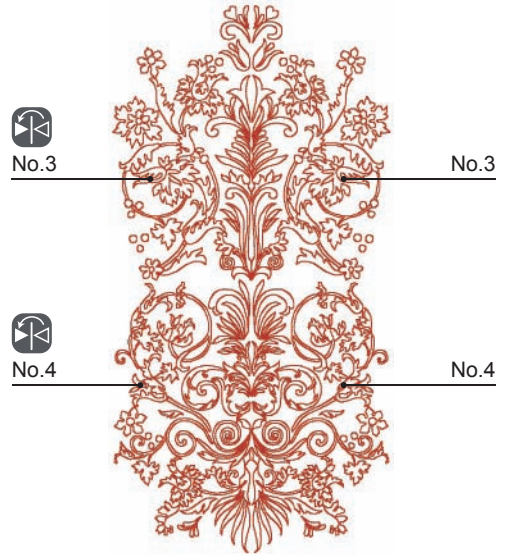
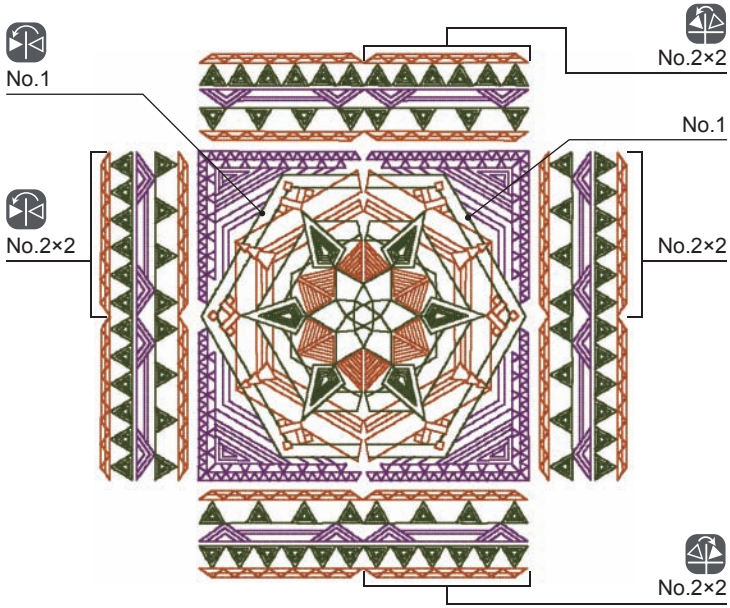
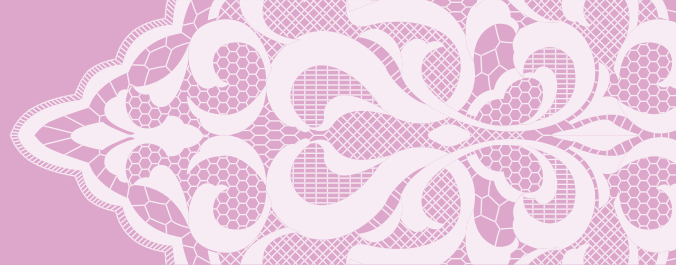

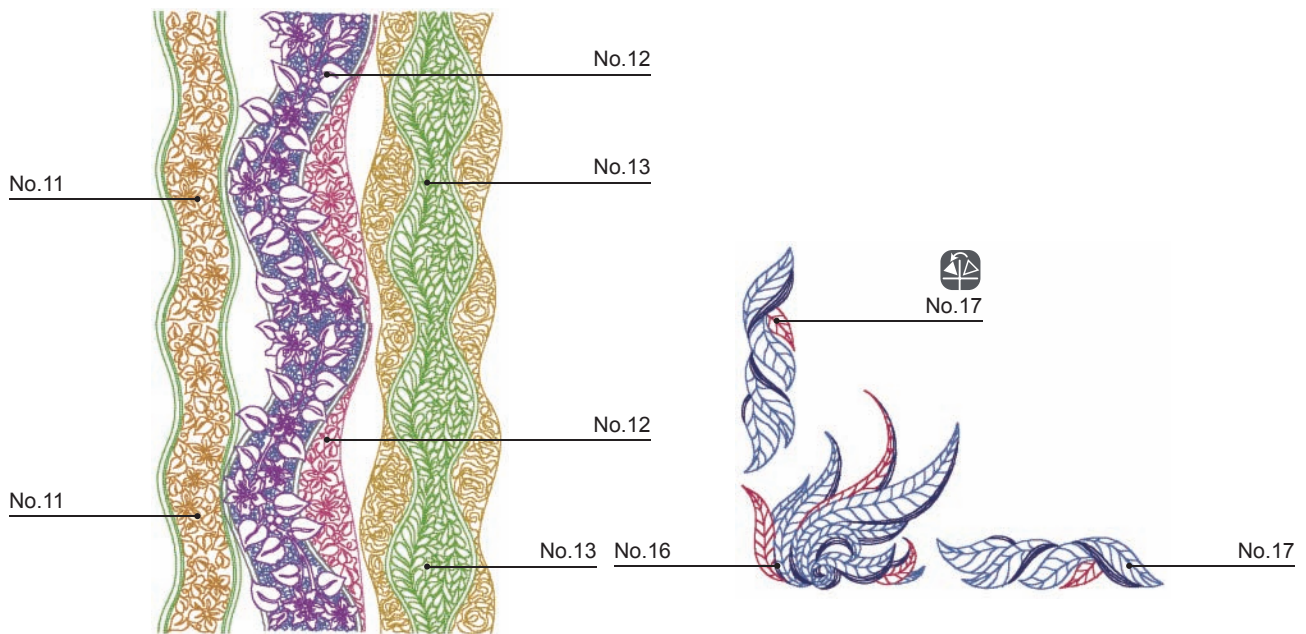
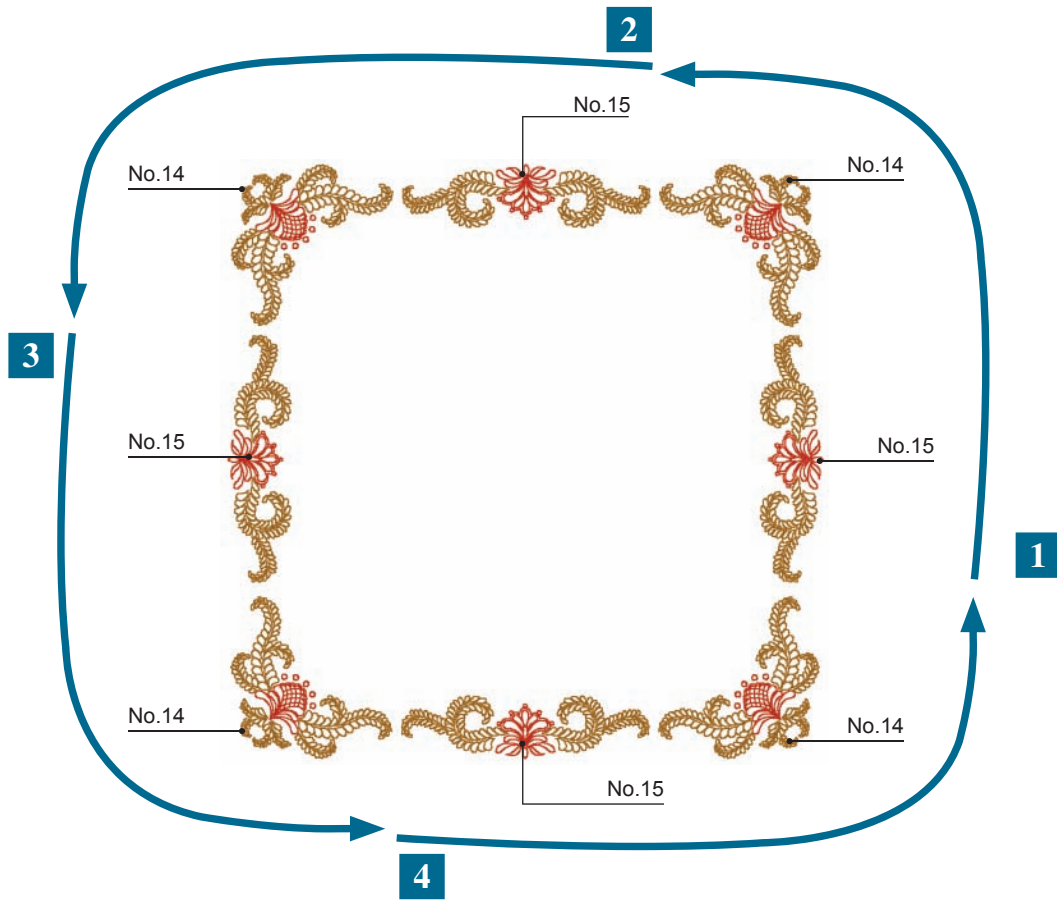

**Positioning symbols:** These symbols indicate how embroidery patterns have been flipped or rotated to create the combined pattern.

**Positionierungssymbole:** Diese Symbole zeigen an, wie Stickmuster für die Musterkombination gespiegelt oder gedreht wurden.

**Symboles de positionnement :** Ces symboles indiquent la manière dont les motifs de broderie ont été inversés ou tournés pour créer le motif combiné.

**Plaatsingsymbolen:** deze symbolen geven aan hoe borduurpatronen zijn gedraaid rond een as of middelpunt om het gecombineerde patroon te creëren.

**Simboli di posizionamento:** questi simboli indicano la modalità di ribaltamento o rotazione dei disegni da ricamo per creare il disegno combinato.

**Símbolos de colocación:** estos símbolos indican cómo se han invertido o girado los patrones de bordado para crear el patrón combinado.



3D combination motifs

Motifs de combinaison 3D

Motivi tridimensionali combinati

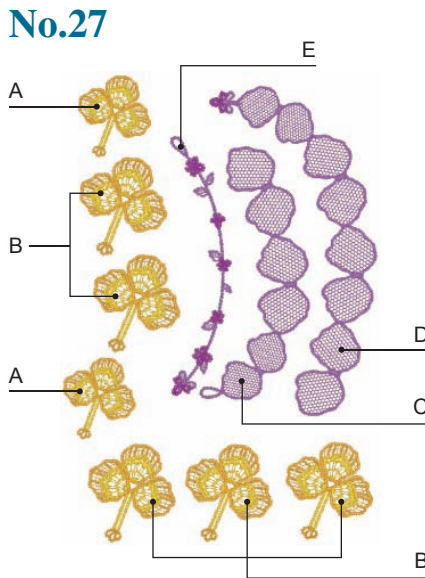

**How to make 3D combination motifs**

1. Use the same color of thread in the bobbin and on top for the designs.
2. Embroider individual shapes. When sections are completed they are joined to make dimensional shapes. Use a thread or narrow ribbon of a complimentary color to join them.
3. Turn off the "Jump stitch thread cutting function" before embroidering. (Refer to the operation manual for directions on how to do this.)

The following are things you should be aware of when using water-soluble sheets without any fabric. When embroidering these designs, please use three layers of water-soluble sheets. Remember to check that you have enough upper thread and lower thread for the design. If the thread breaks during embroidery, back up at least 10 stitches before starting again. If your embroidery machine has a speed reduction feature, select the lowest speed. When dissolving the water-soluble sheet, cut off the unnecessary portions and wash the embroidered piece in warm water until it no longer feels slippery. After the final rinse, dry the embroidery motif until slightly damp, shape by hand or with a cool iron, allow to dry completely.

**Comment réaliser des combinaisons de motifs 3D**

1. Utilisez la même couleur de fil dans la bobine et sur le dessus pour les motifs.
2. Brodez les formes séparément. Lorsque les différentes parties sont complètes, elles sont jointes pour créer des formes en volume. Utilisez un fil ou un ruban étroit d'une couleur complémentaire pour les joindre.
3. Désactivez la « Fonction de coupe des sauts de fils » avant la broderie. (Reportez-vous au Manuel d'instructions pour obtenir les instructions correspondantes.)

Voici ci-dessous les points que vous devez considérer lorsque vous utilisez uniquement des feuilles solubles dans l'eau pour la broderie sans aucun tissu. Lorsque vous brodez ces motifs, veuillez utiliser trois couches de feuilles hydrosolubles. Assurez-vous de bien vérifier que vous avez assez de fil supérieur et de fil inférieur pour le motif. Si le fil casse au cours de la broderie, consolidez au moins 10 points avant de recommencer. Si votre machine à broder est équipée d'une fonction de réduction de la vitesse, veuillez choisir la vitesse la plus lente. Lors de la dissolution de la feuille hydrosoluble, coupez les parties inutiles et lavez la pièce brodée à l'eau tiède jusqu'à ce qu'elle ne soit plus glissante. Après le rinçage final, séchez le motif de broderie jusqu'à ce qu'il ne soit plus que légèrement humide, donnez lui sa forme à la main ou avec un fer à repasser froid avant de le laisser sécher complètement.

**Come creare motivi tridimensionali combinati**

1. Per la parte superiore nei disegni usare lo stesso colore di quello del rocchetto.
2. Ricamare le forme individualmente. Una volta completate le sezioni le si può unire per creare forme dimensionali. Per l'unione si suggerisce di usare un filo o un nastro stretto del colore desiderato.
3. Prima di procedere con il ricamo occorre disattivare la "funzione di taglio saltapunti". (Fare riferimento al manuale d'istruzione per informazioni su come eseguire questa operazione.)

In caso d'uso di pellicole solubili in acqua per ricamo senza tessuto occorre essere consapevoli dei seguenti aspetti: Per ricamare quei disegni si suggerisce di usare tre strati di pellicola solubile in acqua. Ricordare di accertarsi di disporre di filo superiore e inferiore a sufficienza per il disegno. Se durante il ricamo il filo si spezza, prima di riprendere a ricamare tornare indietro almeno dieci punti. Se la propria macchina da cucire dispone della funzione di regolazione della velocità occorre selezionare la più bassa. Durante lo scioglimento della pellicola solubile in acqua occorre rimuovere le parti non necessarie e risciacquare il ricamo in acqua calda sino a quando cessa di essere viscido. Dopo il risciacquo finale il motivo ricamato andrà lasciato asciugare sino a quando rimarrà lievemente umido, quindi gli si darà la forma desiderata a mano o con un ferro da stiro freddo lasciandolo poi asciugare completamente.

3D-Kombinationsmotive

3D-combinatiemotieven

Motivos de combinación 3D

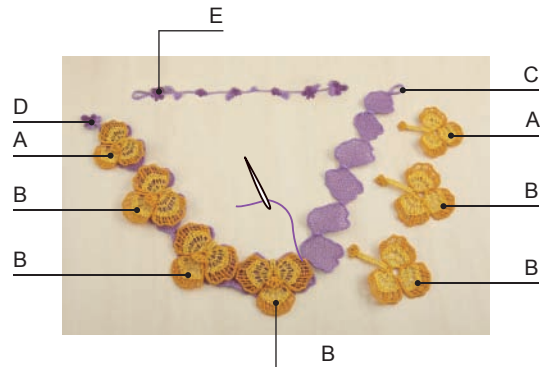
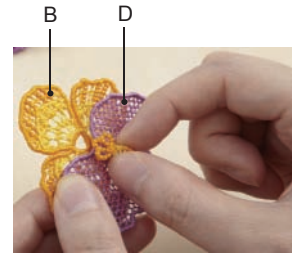

**Anfertigen von 3D-Kombinationsmotiven**

1. Verwenden Sie für die Muster Faden derselben Farbe in der Spule und oben.
2. Sticken Sie die einzelnen Formen. Die fertigen Abschnitte werden zusammengefügt, um plastische Formen zu schaffen. Verwenden Sie zum Zusammenfügen ein Garn oder schmales Band in einer passenden Farbe.
3. Schalten Sie die „Sprungnaht-Abschneidefunktion“ vor dem Sticken aus. (Hinweise dazu, siehe Bedienungsanleitung.)

Die folgenden Punkte sind zu beachten, wenn für eine Stickarbeit nur wasserlösliche Folie ohne Stoff verwendet wird. Verwenden Sie beim Sticken solcher Muster bitte drei Lagen wasserlösliche Folie. Achten Sie darauf, dass ausreichend Ober- und Unterfaden für das Muster vorhanden ist. Sollte der Faden beim Sticken reißen oder ausgehen, gehen Sie zum Weitersticken mindestens 10 Stiche zurück. Falls Ihre Stickmaschine eine Geschwindigkeitsregelung hat, wählen Sie die langsamste Stufe. Zum Auflösen der wasserlöslichen Folie schneiden nicht benötigte Teile ab und waschen die Stickarbeit in warmem Wasser aus, bis sie sich nicht mehr schlüpfrig anfühlt. Nach dem letzten Spülgang lassen Sie das Stickmotiv trocknen, bis es leicht feucht ist, formen es von Hand oder mit einem kalten Bügeleisen aus, und lassen es dann vollständig trocknen.

**Hoe maak ik 3D Combinatiemotiefjes**

1. Gebruik dezelfde kleur draad in de spoel en in de bovenkant voor elk ontwerp.
2. Borduur afzonderlijke vormen. Als alle onderdelen klaar zijn worden ze bij elkaar gevoegd om dimensionale vormen te maken. Gebruik draad of lint van een gepaste kleur om de onderdelen samen te voegen.
3. Zet de "Sprongsteek afsnijfunctie" uit voordat U begint met borduren. (Zie de bedieningshandleiding voor aanwijzingen over hoe u te werk moet gaan.)

Als U alleen wateroplosbaar papier gebruikt voor het borduren zonder textiel, dient U de volgende dingen in acht te houden. Indien U die ontwerpen borduurt, gebruik dan drie lagen van het wateroplosbare papier. Vergeet niet van tevoren vast te stellen dat U genoeg bovendraad en onderdraad voor het ontwerp heeft. Mocht de draad breken tijdens het borduren, ga dan minstens 10 steken terug voordat U weer opnieuw begint. Als uw borduurmachine een functie voor snelheidsreductie heeft, kies dan de laagst mogelijke snelheid. Wanneer U het wateroplosbare papier oplost, verwijder de onnodige delen en was het borduurwerk in warm water tot het niet meer glad aanvoelt. Laat na de laatste spoelbeurt het borduurmotief drogen tot het licht vochtig is, vorm het vervolgens met de hand of met een koud strijkijzer, en laat het volledig drogen.

**Cómo realizar motivos de combinación 3D**

1. Utilice el mismo color de hilo en la bobina y en la parte superior para los diseños.
2. Borda talles individuales. Cuando se finalizan las secciones, se juntan para componer talles dimensionales. Utilice un hilo o una cinta estrecha de color complementario para unirlos.
3. Desactive la función de "Saltar el corte del hilo de coser" antes de bordar. (Consulte en el manual de instrucciones el procedimiento para hacerlo.)

A continuación se indica lo que usted deberá tener en cuenta cuando utilice solamente láminas solubles en agua para bordar sin ninguna tela. Cuando borde tales diseños, utilice tres capas de láminas solubles en agua. No se olvide de comprobar si tiene hilo superior e inferior para el diseño. Si el hilo se rompe durante el bordado, vuelva atrás 10 puntadas por lo menos antes de comenzar de nuevo. Si su máquina de bordar posee función de reducción de velocidad, seleccione la velocidad más baja. Cuando disuelva la lámina soluble en agua, corte las partes innecesarias, y lave la pieza bordada en agua caliente hasta que deje de notarse resbaladiza. Después del lavado final, seque el adorno bordado hasta que esté ligeramente húmedo, déle forma con la mano o con un plancha fría, y deje que se seque completamente.



# Color Thread Conversion Chart











































































## Tableau de conversion des fils de couleur

### Tabella di conversione dei fili colorati

# Stickgarn-Farbtabelle

## Omzettingstabel voor kleurgaren

### Tabla de conversión de hilos de color

	Color Name / Name der Farbe / Nom de la couleur / Kleur naam / Nome del colore / Nombre de color	Embroidery	Country	Madeira Polyneon	Madeira Rayon	Sulky	R.A. Polyster
1	Black / Schwarz / Noir / Zwart / Nero / Negro	 900	 100	1800	1000	1005	5596
2	White / Weiss / Blanc / Wit / Bianco / Blanco	 001	 000	1801	1002	1001	5597
3	Red / Rot / Rouge / Rood / Rosso / Rojo	 800	 149	1637	1037	1037	5678
4	Pink / Rosa / Rose / Rose / Rosa / Rosado	 085	 155	1921	1108	1224	5523
5	Deep Rose / Tiefrot / Rose foncé / Roserood / Rosa Intenso / Rosa Intenso	 086	 024	1721	1117	1154	9168
6	Flesh Pink / Fleischfarben / Rose chair / Lichtrose / Rosa Carne / Rosa Claro	 124	 152	1915	1015	1064	5677
7	Dark Fuchsia / Dunkelviolett / Fuchsia foncé / Donker Fuchsia Paars / Fuchsia Scuro / Fuscia Oscuro	 107	 126	1984	1383	1533	5804
8	Vermillion / Zinnoberrot / Vermillon / Vermil Joen / Rosso Vermiglio / Bermellon	 030	 148	1779	1179	1184	9023
9	Carmine / Karminrot / Carmin / Karmijn / Rosso Carminio / Carmin	 807	 158	1986	1081	1511	5561
10	Royal Purple / Königspurpur / Pourpre royal / Dieppaars / Rosso-Violaceo / Violeta Real	 869	 636	1788	1188	1192	5681
11	Magenta / Magenta / Magenta / Magenta / Magenta / Magenta	 620	 625	1710	1319	1191	5592
12	Salmon Pink / Lachsrosa / Rose saumon / Zalmrose / Rosa Salmone / Rosa Salmon	 079	 122	1816	1317	1225	5773
13	Amber Red / Bernsteinrot / Rouge ambre / Amber Rood / Rosso Ambra / Rojo Ambar	 333	 212	1942	1341	1119	5591
14	Lemon Yellow / Zitronengelb / Jaune citron / Citroengeel / Giallo Limone / Amarillo Limon	 202	 342	1623	1023	1067	5625
15	Yellow / Gelb / Jaune / Geel / Giallo / Amarillo	 205	 043	1980	1068	1187	5860
16	Harvest Gold / Erntegold / Or blé / Oogst Kleurig Goud / Giallo Grano / Amarillo Trigo	 206	 334	1971	1024	1124	5770
17	Orange / Orange / Orange / Oranje / Arancio / Naranja	 208	 335	1951	1137	1024	5694
18	Pumpkin / Kürbisgelb / Citrouille / Pompoen / Giallo Zucca / Calabaza	 126	 322	1952	1155	1065	5630
19	Tangerine / Mandarinenorange / Tangerine / Felorange / Mandarino / Tangerina	 209	 336	1965	1078	1078	5518
20	Cream Brown / Braun Weiss / Brun crème / Creme Bruin / Nocciaola / Marron Crema	 010	 331	1866	1022	1061	5761
21	Cream Yellow / Gelblich Weiss / Jaune crème / Cremegeel / Giallo Crema / Amarillo Crema	 812	 370	1861	1349	1135	5564
22	Khaki / Khakibraun / Kaki / Khaki / Kaki / Caqui	 348	 242	1939	1255	1055	5636
23	Deep Gold / Tiefgold / Or foncé / Diepgoud / Oro Scuro / Amarillo Oro	 214	 354	1772	1172	1025	5770
24	Brass / Messingfarben / Cuivre / Koper / Ottone / Bronce	 328	 404	1791	1192	1159	9109
25	Linen / Leinen Farbig / Drap / Linnen / Lino / Lino	 307	 025	1682	1149	1082	5635
26	Dark Brown / Dunkelbraun / Brun sombre / Donker Bruin / Marrone Scuro / Marron Oscuro	 058	 717	1859	1130	1129	5637
27	Reddish Brown / Rotbraun / Brun rougeâtre / Rossing Bruin / Marrone Bruciato / Marron Rojizo	 337	 264	1753	1253	1021	5781
28	Clay Brown / Lehm Braun / Brun argile / Kleibruin / Marrone Argilla / Marron Tierra	 339	 224	1621	1021	1158	5590
29	Beige / Beige / Beige / Beige / Beige / Beige	 843	 012	1738	1138	1127	5598
30	Warm Gray / Warmgrau / Gris vif / Warm Grijs / Grigio Caldo / Gris Caliente	 399	 706	1860	1085	1218	9126
31	Russet Brown / Rotbraun / Brun roussâtre / Roodbruin / Ruggine / Marron Bermejo	 330	 414	1726	1194	1126	5702
32	Light Brown / Hellbraun / Brun clair / Licht Bruin / Marrone Chiaro / Marron Claro	 323	 255	1729	1056	1128	5789
33	Seacrest / Blassgrün / Vert Pale / Blauw Groen / Cresta Di Mare / Verde Celadon	 542	 505	1647	1219	1077	5578
34	Mint Green / Pfefferminzgrün / Vert menthe / Munt Groen / Verde Menta / Verde Menta	 502	 461	1702	1302	1047	5511
35	Leaf Green / Blattgrün / Vert feuille / Bladgroen / Verde Prato / Verde De Hoja	 509	 463	1749	1050	1510	5514
36	Olive Green / Olivgrün / Vert olive / Olijf Groen / Verde Oliva / Verde Oliva	 519	 476	1904	1396	1174	5502
37	Dark Olive / Dunkelolivgrün / Olive foncé / Donker Olijf / Oliva Scuro / Verde Oliva Oscuro	 517	 473	1769	1156	1156	9122
38	Teal Green / Blaugrün / Vert sarcelle / Taling Groen / Verde Anatra / Verde Azulado	 534	 483	1879	1298	1503	5751
39	Emerald Green / Emerald Grün / Vert émeraude / Smaragd Groen / Verde Smeraldo / Verde Esmeralda	 507	 485	1750	1250	1079	5508

