

brother®

Quick reference guide

Kurzanleitung

Guide de référence rapide

Beknopte bedieningsgids

Guida di riferimento rapido

Guía de referencia rápida



Refer to the operation manual for detailed instruction.

Also, there are differences in the keys and screens depending on the display language. In this guide, English screens are used for basic explanations.

Einzelheiten entnehmen Sie bitte der Bedienungsanleitung.

Je nachdem, welche Sprache für die Bildschirmanzeigen gewählt wurde, ergeben sich im Hinblick auf Bildschirmbilder eventuell Unterschiede.

Die grundlegende Bedienung der Maschine ist in dieser Anleitung am Beispiel von Bildschirmbildern mit englischem Text erklärt.

Pour les instructions détaillées, voir le mode d'emploi.

Par ailleurs, il y a des différences dans les touches et les écrans en fonction de la langue d'affichage.

Dans ce guide, les explications de base utilisent les écrans anglais.

Zie de gebruiksaanwijzing voor gedetailleerde instructies.

Er zijn verschillen in de toetsen en schermen afhankelijk van de ingestelde taal.

In de beschrijvingen in deze beknopte handleiding worden de Engelse schermen gebruikt.

Fare riferimento al manuale d'istruzioni per le istruzioni dettagliate.

Inoltre, ci sono differenze nei tasti e nelle schermate a seconda della lingua visualizzata.

In questa guida, le schermate in inglese sono usate per le spiegazioni basilari.

Consulte el manual de instrucciones para ver más detalles.

Además, dependiendo del idioma visualizado algunos botones y pantallas podrán ser diferentes.

En esta guía, para las explicaciones básicas se emplean pantallas en inglés.

<English display>
<Englische Anzeige>
<Affichage en anglais>
<Engels scherm>
<Schermata in inglese>
<Visualización en inglés>

<Example: German>
<Beispiel: Deutsch>
<Exemple : allemand>
<Voorbeeld: Duits>
<Esempio: Tedesco>
<Ejemplo: Alemán>

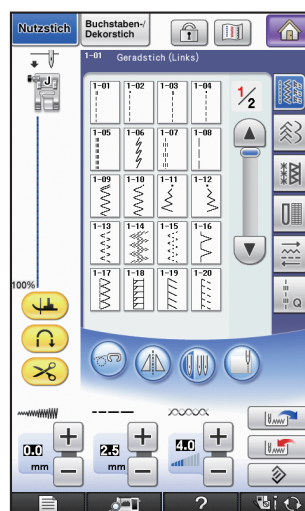
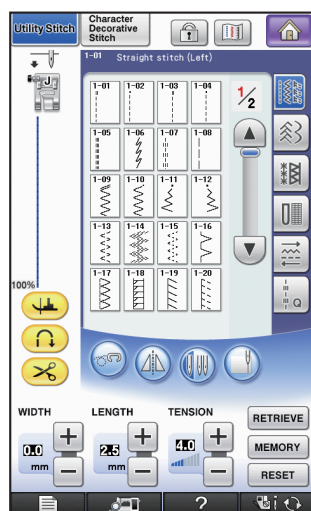

Contents

- 2 Winding the Bobbin
- 4 Setting the Bobbin
- 5 Upper Threading
- 6 Preparing to Embroider
- 8 Selecting Stitch Patterns
- 13 Summary of Stitch Patterns
- 31 Embroidery Pattern Color Change Table
- 75 Examples of Combinations
- 87 Color Thread Conversion Chart

Table des matières

- 2 Bobinage de la canette
- 4 Mise en place de la canette
- 5 Enfilage supérieur
- 6 Préparation de la broderie
- 8 Sélection des configurations de point
- 13 Sommaire des motifs de point
- 31 Tableau de changement de couleur des motifs de broderie
- 75 Exemples de combinaisons
- 87 Tableau de conversion des fils de couleur

Sommario

- 2 Avvolgimento della spolina
- 4 Impostazione della spolina
- 5 Infilatura superiore
- 6 Preparativi per il ricamo
- 8 Selezione degli schemi punto
- 13 Sommario degli schemi punto
- 31 Tabella di cambiamento colori degli schemi di ricamo
- 75 Esempi di combinazioni
- 87 Tabella di conversione dei fili colorati

Inhalt

- 2 Aufspulen des Unterfadens
- 4 Einsetzen der Spule
- 5 Einfädeln des Oberfadens
- 6 Vorbereitung zum Sticken
- 8 Wahl des Nähmusters
- 13 Nähmuster-Übersicht
- 31 Stickmuster-Farbtabelle
- 75 Kombinationsbeispiele
- 87 Stickgarn-Farbtabelle

Inhoudsopgave

- 2 Spoel opwinden
- 4 Aanbrengen van het spoeltje
- 5 Inrijgen van de bovendraad
- 6 Voorbereidingen voor borduren
- 8 Kiezen van de steekpatronen
- 13 Overzicht van de steekpatronen
- 31 Kleurwijzigingstabel voor de borduurpatronen
- 75 Voorbeelden van combinaties
- 87 Omzettingstabel voor kleurgaren

Contenido

- 2 Devanado de la bobina
- 4 Colocación de la bobina
- 5 Hilo superior
- 6 Preparativos para bordar
- 8 Selección de tipos de puntada
- 13 Resumen de tipos de puntada
- 31 Tabla de cambio de color para patrones de bordado
- 75 Ejemplos de combinaciones
- 87 Tabla de conversión de hilos de color

Winding the Bobbin Bobinage de la canette Avvolgimento della spolina

Aufspulen des Unterfadens Spoel opwinden Devanado de la bobina

Follow the numbered steps below in order. Refer to the operation manual for detailed instruction.
Führen Sie die folgenden Schritte in der angegebenen Reihenfolge aus. Ausführliche Hinweise finden Sie in der Bedienungsanleitung.
Suivez les étapes numérotées ci-dessous dans l'ordre. Consultez le manuel d'instructions pour des procédures détaillées.
Voer de genummerde stappen uit in de juiste volgorde. Uitvoerige aanwijzingen vindt u in de bedieningshandleiding.
Seguire i passaggi numerati nell'ordine riportato di seguito. Fare riferimento al manuale d'istruzioni per le istruzioni dettagliate.
Realice los siguientes pasos numerados en el orden indicado. Para obtener instrucciones detalladas, consulte el manual de instrucciones.

Use only the enclosed bobbin or bobbins of the same type.
Verwenden Sie nur die im Lieferumfang enthaltene Spule oder Spulen vom selben Typ.
N'utilisez que la canette fournie ou des canettes du même type.
Gebruik alleen de bijgeleverde spoel of spoelen van hetzelfde type.
Utilizzare solo la spolina inclusa o spoline dello stesso tipo.
Utilice sólo la bobina incluida o bobinas del mismo tipo.

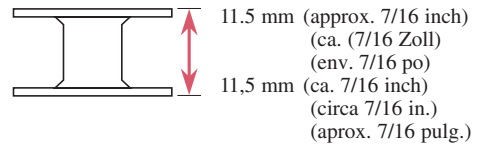

Using the Supplemental Spool Pin

You can wind the bobbin during sewing.

Verwendung des zusätzlichen Garnrollenstifts

Sie können den Unterfaden während des Nähens aufspulen.

Utilisation du porte-bobine supplémentaire

Vous pouvez bobiner la canette pendant la couture.

Gebruik van de klospen

U kunt de spoel opwinden tijdens het naaien.

Utilizzo del portarocchetto supplementare

È possibile avvolgere la spolina durante la cucitura.

Uso del portacarrete suplementario

Puede devanar la bobina mientras está cosiendo.

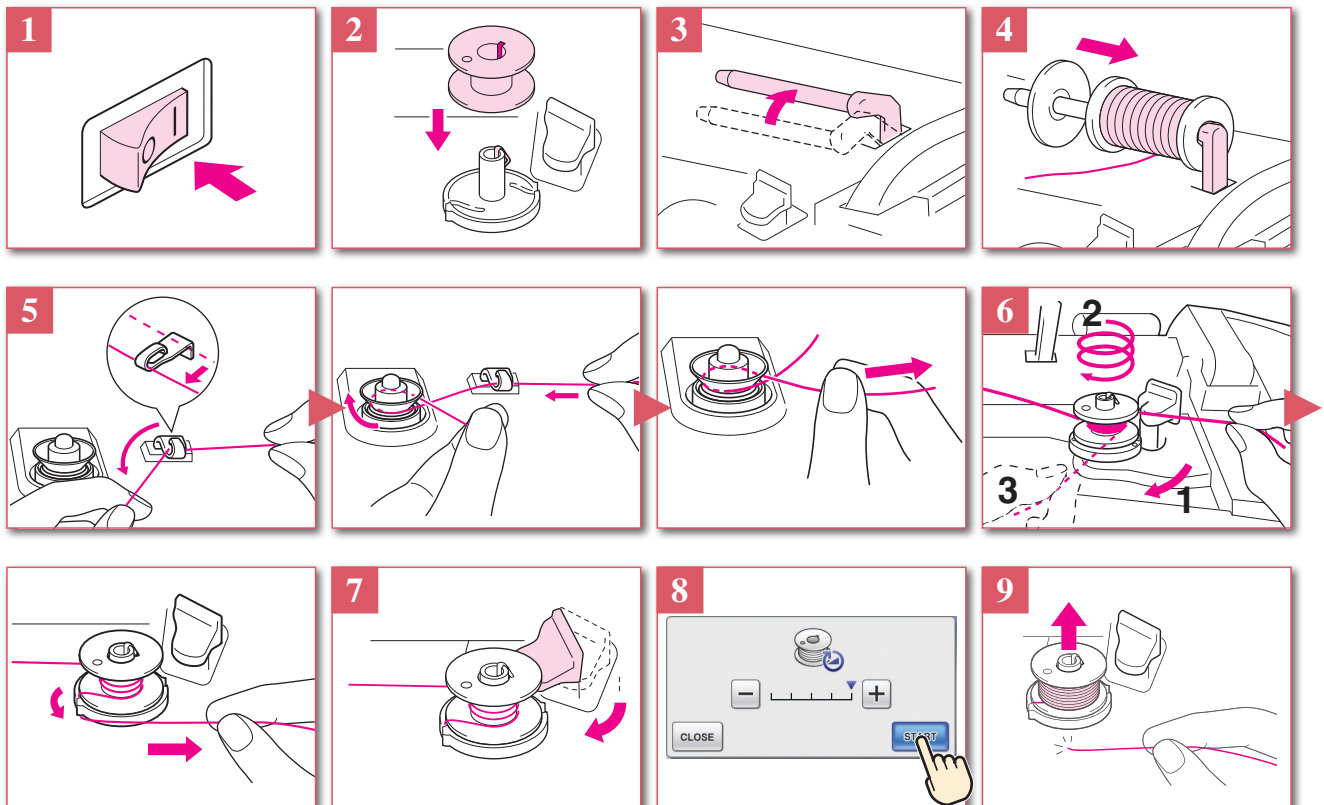
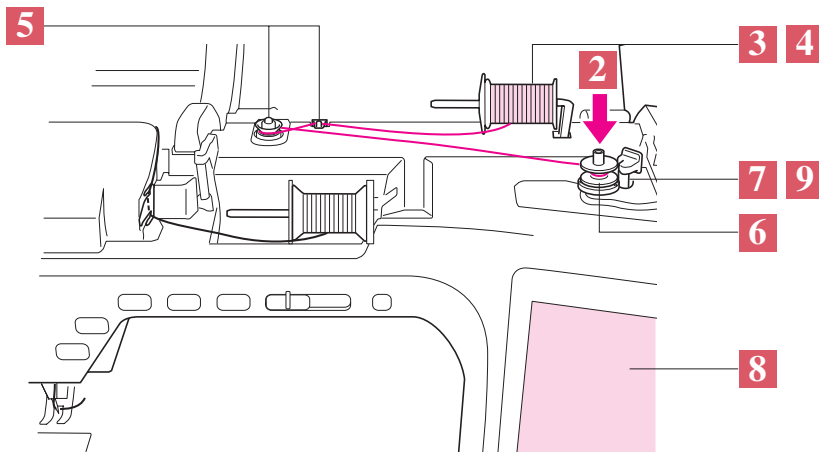



Using the Spool Pin

You can use the main spool pin to wind the bobbin before sewing.

Gebruik van de klospen

Voordat u gaat naaien kunt u met de hoofdklospen de spoel opwinden.

Verwendung des Garnrollenstifts

Mit dem Hauptgarnrollenstift können Sie vor dem Nähen den Unterfaden aufspulen.

Utilizzo del portarocchetto

È possibile utilizzare il portarocchetto principale per avvolgere la spolina prima di cucire.

Utilisation du porte-bobine

Vous pouvez bobiner la canette avant de coudre à l'aide du porte-bobine principal.

Uso del portacarrete

Puede utilizar el portacarrete principal para devanar la bobina antes de coser.

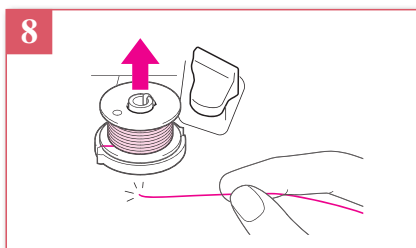
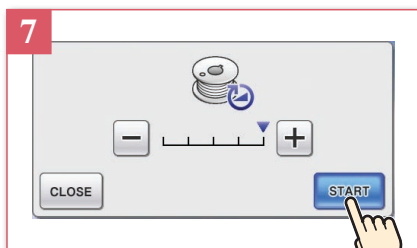
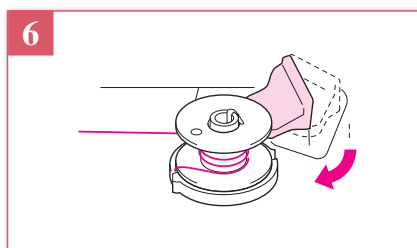
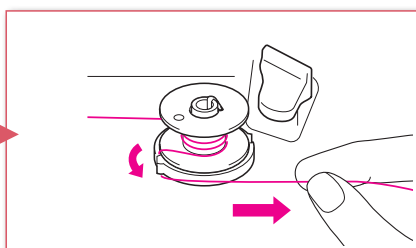
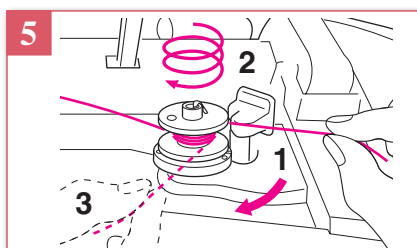
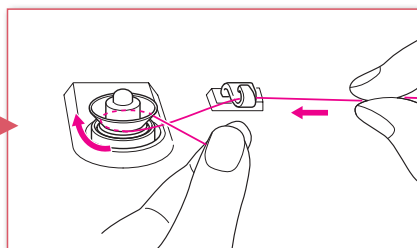
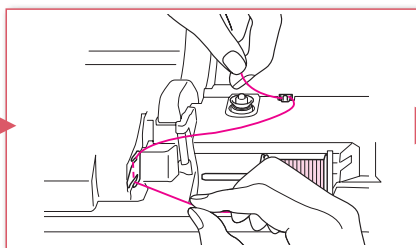
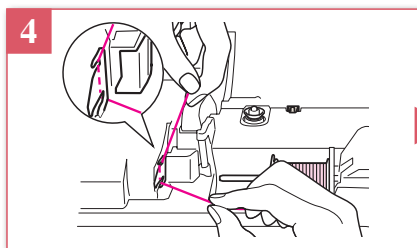
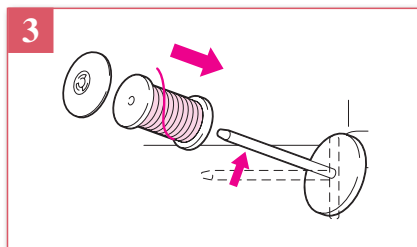
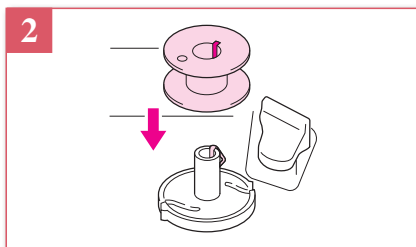
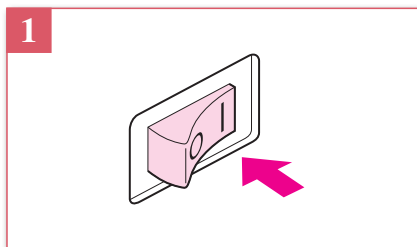
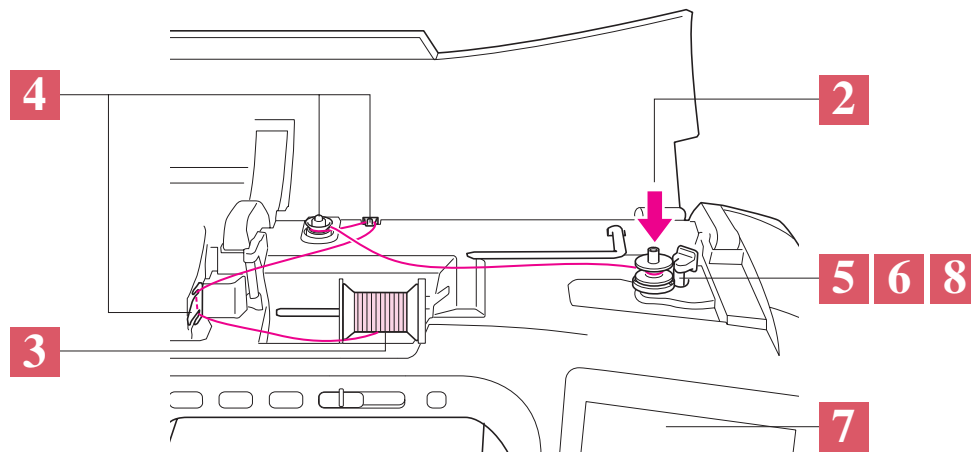

Setting the Bobbin

Mise en place de la canette

Impostazione della spolina

Einsetzen der Spule

Aanbrengen van het spoeltje

Colocación de la bobina

Refer to the operation manual for detailed instruction.

Einzelheiten hierzu entnehmen Sie bitte der Bedienungsanleitung.

Pour les instructions détaillées, voir le mode d'emploi.

Zie de gebruiksaanwijzing voor gedetailleerde instructies.

Fare riferimento al manuale d'istruzioni per le istruzioni dettagliate.

Consulte el manual de instrucciones para ver más detalles.

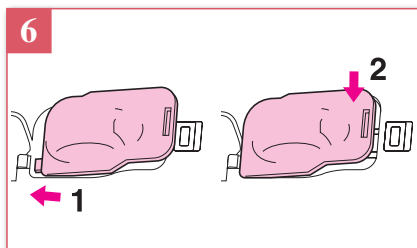
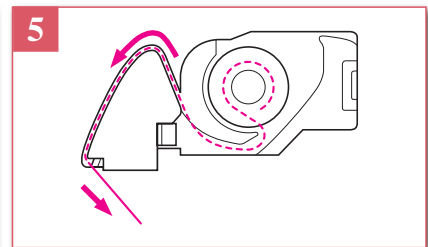
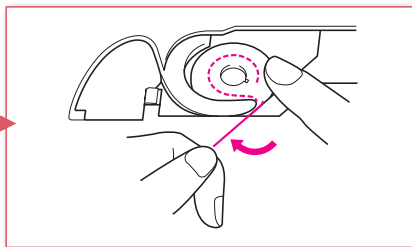
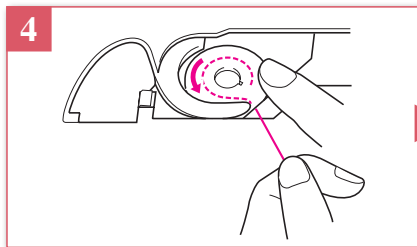
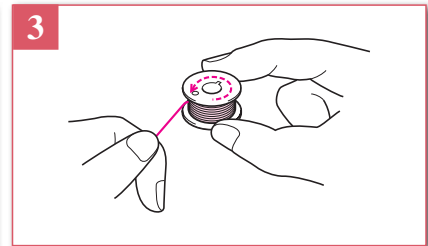
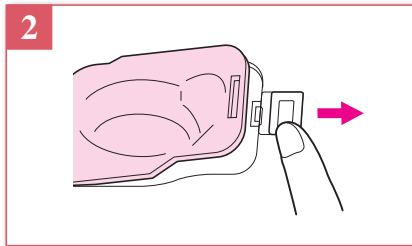
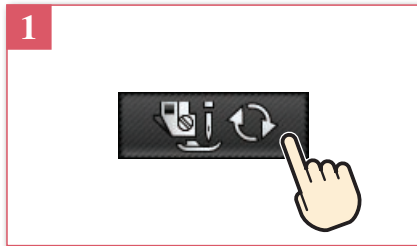

Upper Threading
Enfilage supérieur
Infilatura superiore

Einfädeln des Oberfadens
Inrijgen van de bovendraad
Hilo superior

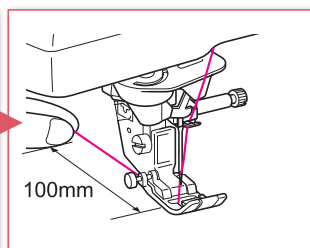
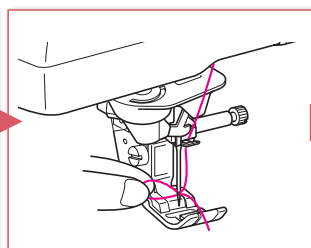
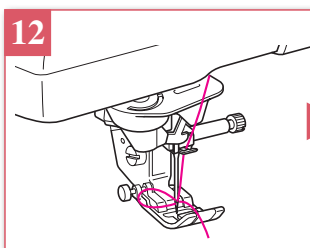
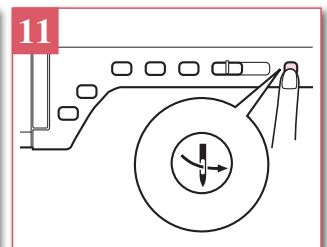
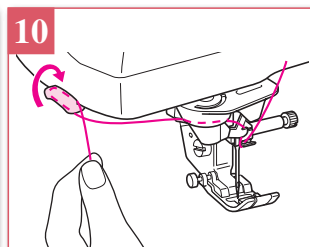
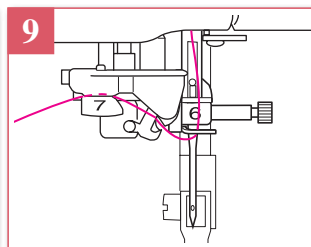
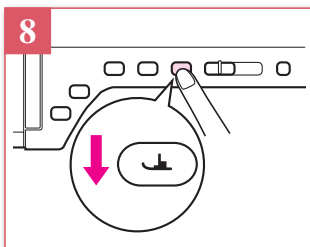
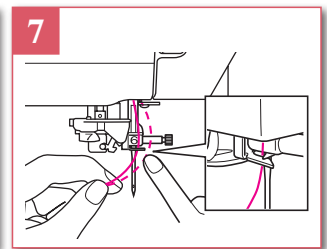
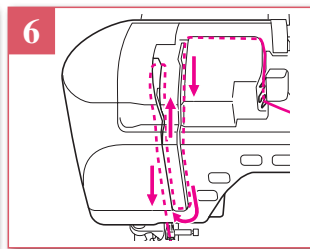
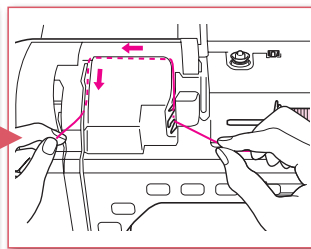
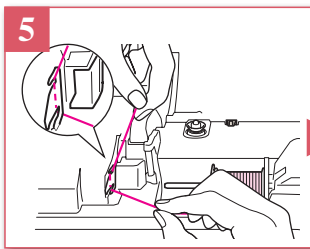
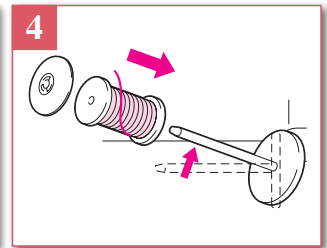
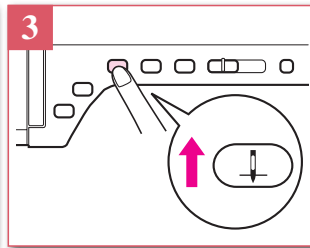
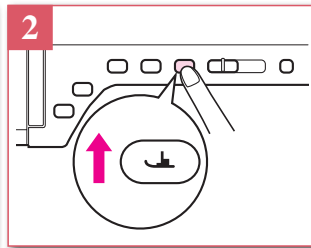
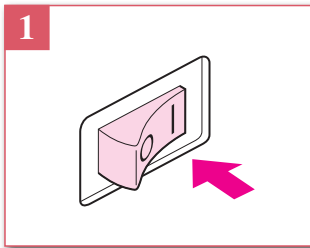
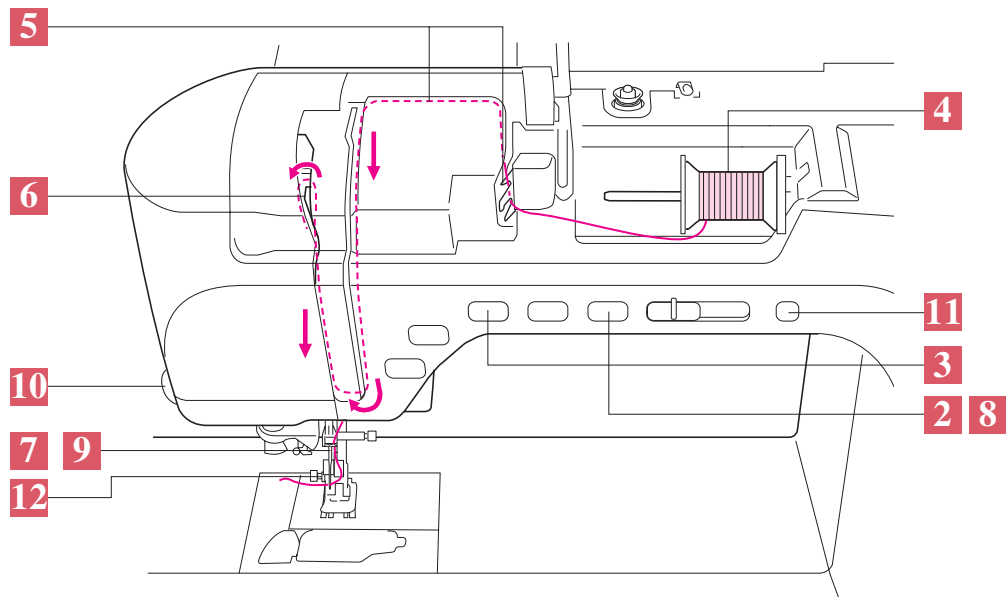

Preparing to Embroider
 Préparation de la broderie
 Preparativi per il ricamo

Vorbereitung zum Sticken
 Voorbereidingen voor borduren
 Preparativos para bordar

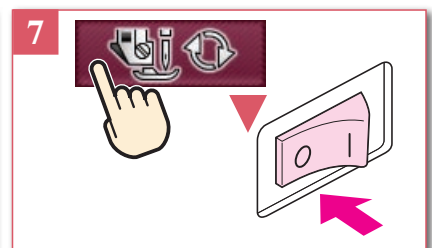
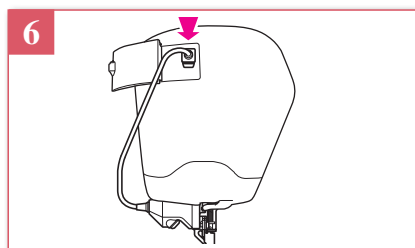
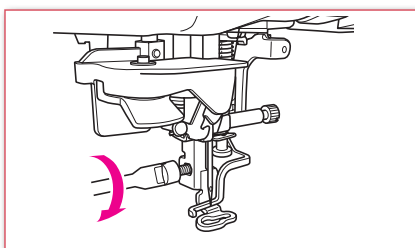
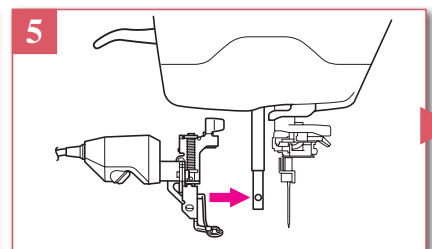
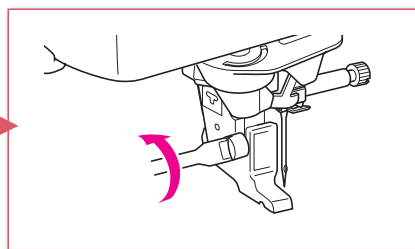
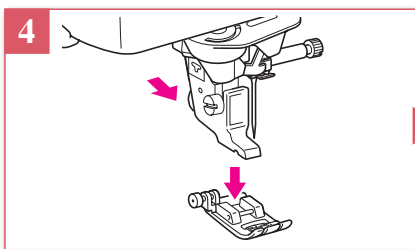
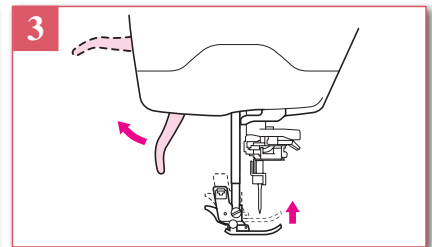
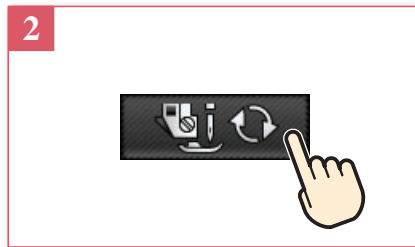
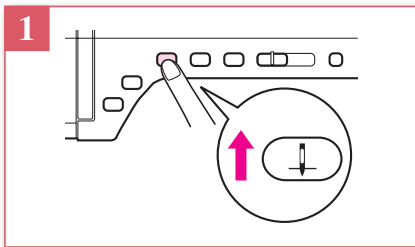
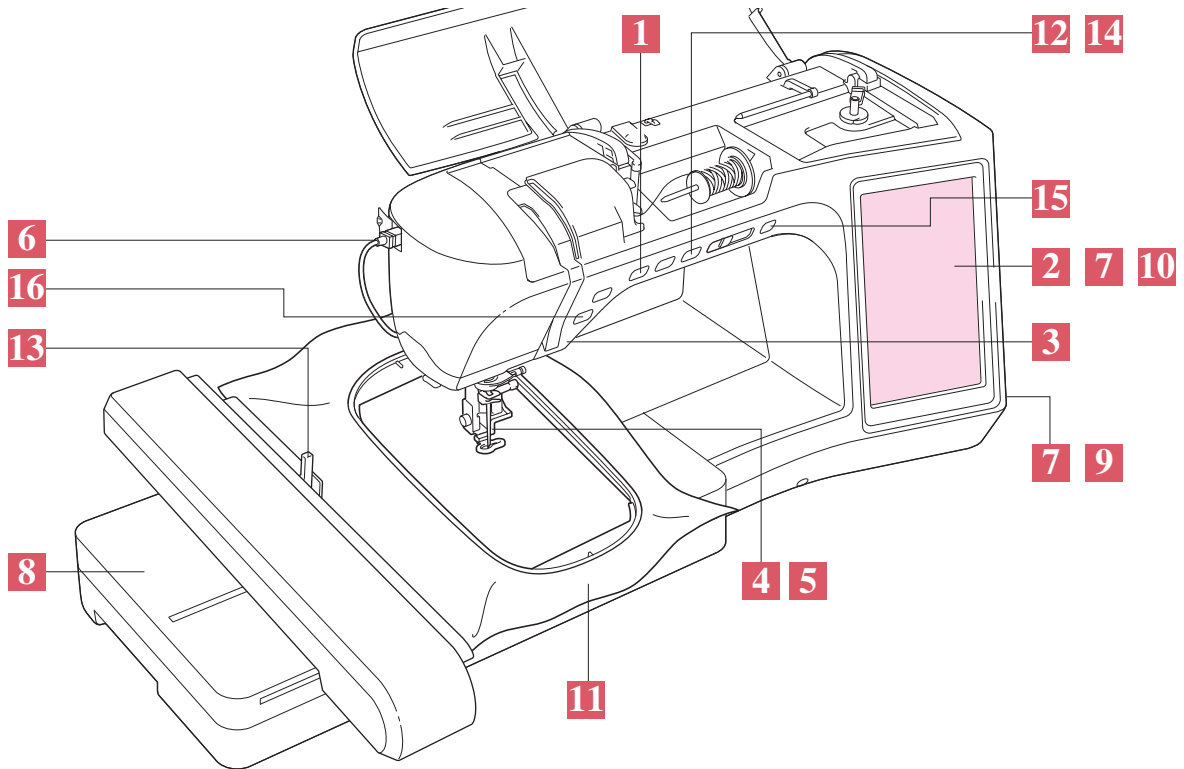

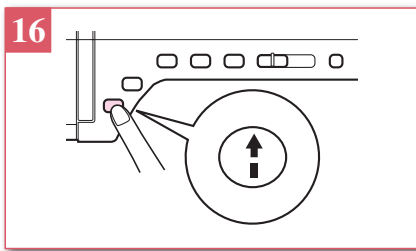
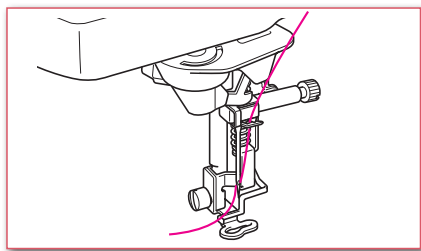
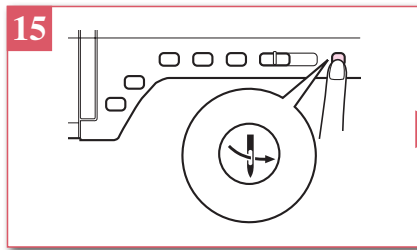
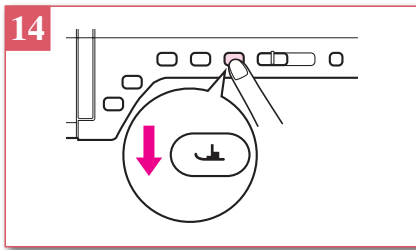
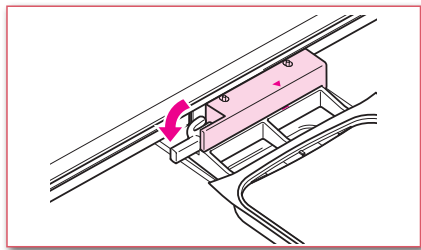
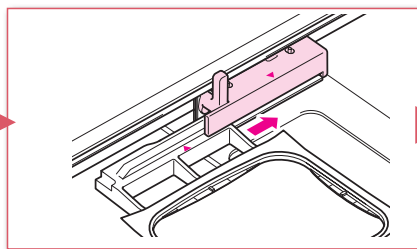
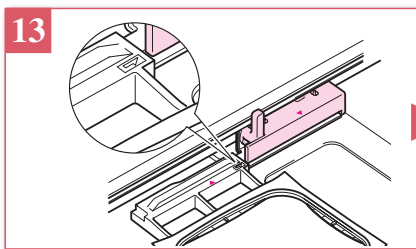
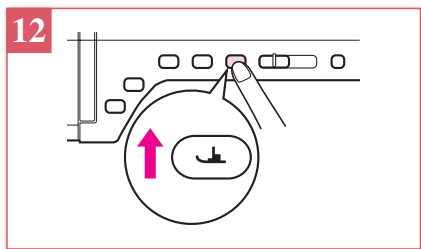
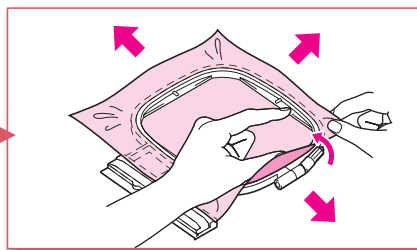
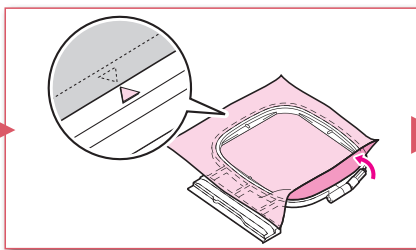
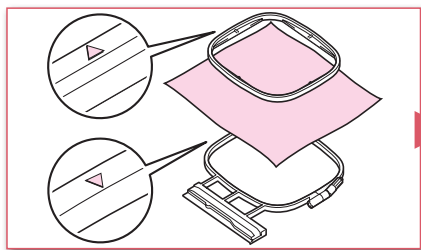
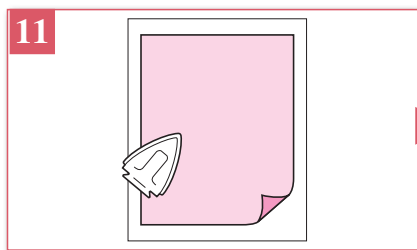
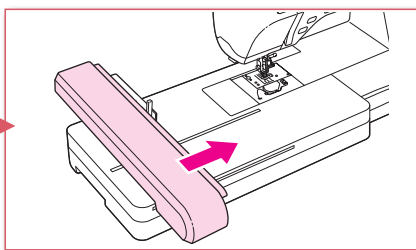
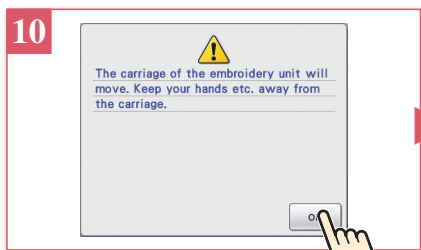
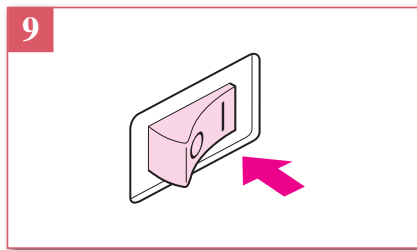
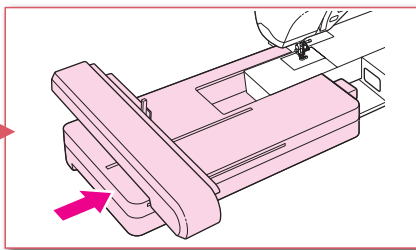
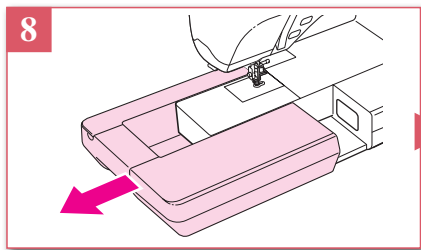
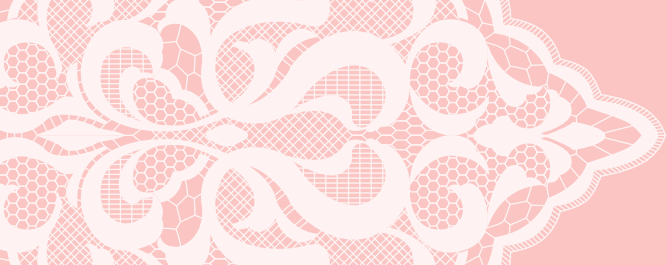

Selecting Stitch Patterns

Sélection des configurations de point

Selezione degli schemi punto

Wahl des Nähmusters

Kiezen van de steekpatronen

Selección de tipos de puntada

- ◀ LCD Flow Chart
- ◀ LCD-Übersichtsdiagramm
- ◀ Organigramme de l'écran à cristaux liquides
- ◀ LCD-stroomschema
- ◀ Schema di flusso LCD
- ◀ Diagrama de flujo del LCD

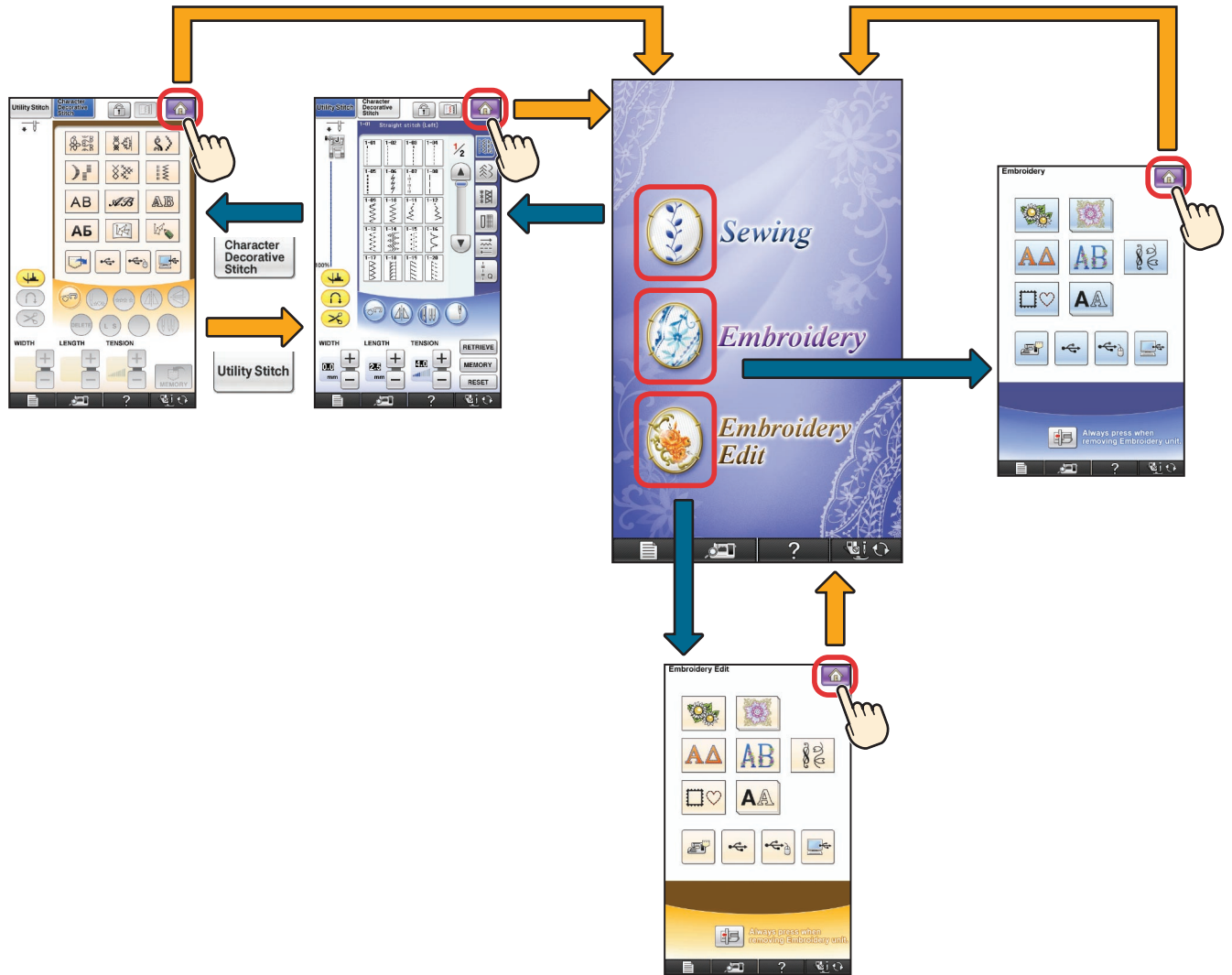

Utility Stitches

When the machine is turned on, the home screen is displayed after the opening movie is played. Press  to display the utility stitch. Either "1-01 Straight stitch (Left)" or "1-03 Straight stitch (Middle)" is selected, depending on the setting selected in the setting screen.

Naaisteken

Wanneer u de machine aanzet, verschijnt het startscherm nadat het openingsfilmpje is vertoond. Druk op  om de naaistek te tonen. Ofwel "1-01 Rechte steek (links)" of "1-03 Rechte steek (midden)" is geselecteerd, naar gelang de instelling die is geselecteerd in het instellingscherm.

Nutzstiche

Bei Einschalten der Maschine erscheint nach Abspielen des Eröffnungsfilms der Startbildschirm. Drücken Sie  zur Anzeige der Nutzstiche. Je nach Einstellung im Einstellbildschirm ist "1-01 Geradstich (links)" oder "1-03 Geradstich (Mitte)" ausgewählt.

Punti utili

Quando si accende la macchina, la schermata iniziale viene visualizzata dopo la riproduzione del film di apertura. Premere  per visualizzare il punto utile. Viene selezionato "1-01 Punto diritto (sinistra)" o "1-03 Punto diritto (centrale)", a seconda dell'impostazione selezionata nella schermata delle impostazioni.

Points utilitaires

Lorsque la machine est mise sous tension, l'écran d'accueil s'affiche après la lecture de la vidéo de démarrage. Appuyez sur  pour afficher le point de couture courant. « 1-01 point droit (gauche) » ou « 1-03 point droit (milieu) » est sélectionné, en fonction du réglage choisi sur l'écran de réglages.

Puntadas útiles

Cuando encienda la máquina y, una vez visualizada la película de presentación, aparecerá la pantalla principal. Pulse  para ver la costura de utilidad. Se seleccionará la "Puntada recta 1-01 (izquierda)" o la "Puntada recta 1-03 (medio)", según el ajuste seleccionado en la pantalla de ajustes.

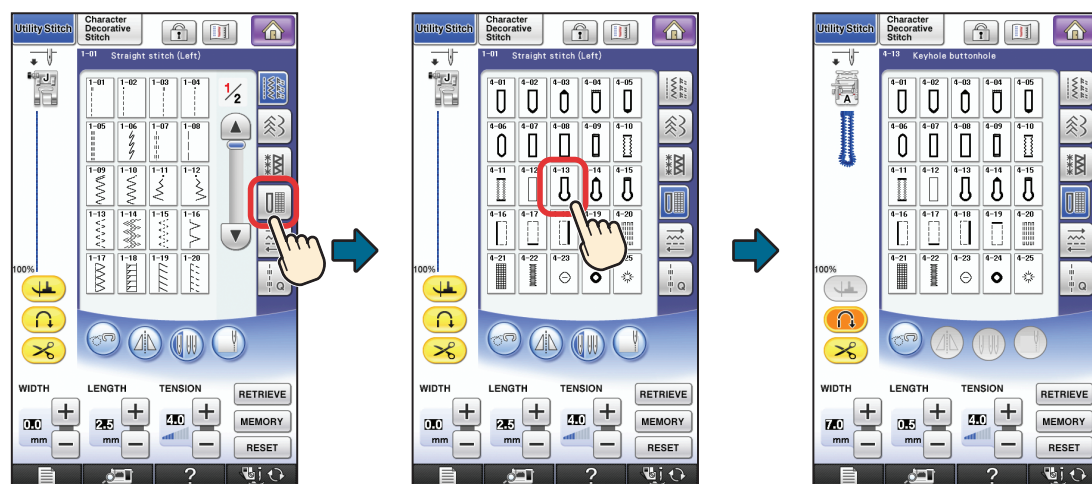

Character/Decorative Stitches

Buchstaben/Dekorative Stichmuster

Caractères/points décoratifs

Letter/decoratieve steken

Punti per caratteri/decorazioni

Puntadas de letras/decorativas

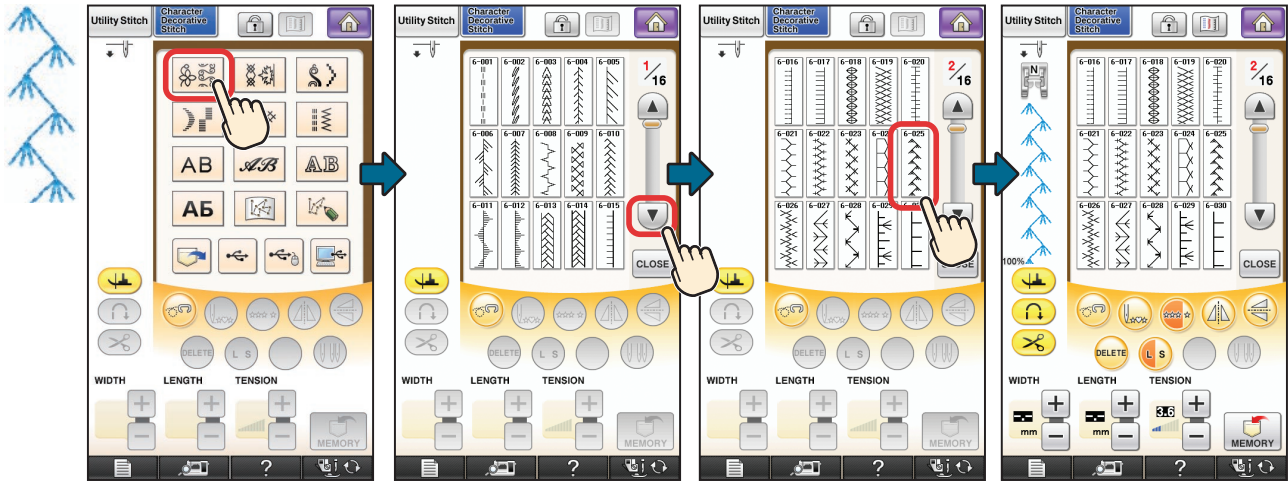

Embroidery Patterns

Stickmuster

Motifs de broderie

Borduurpatronen

Schemi di ricamo

Patrones de bordado

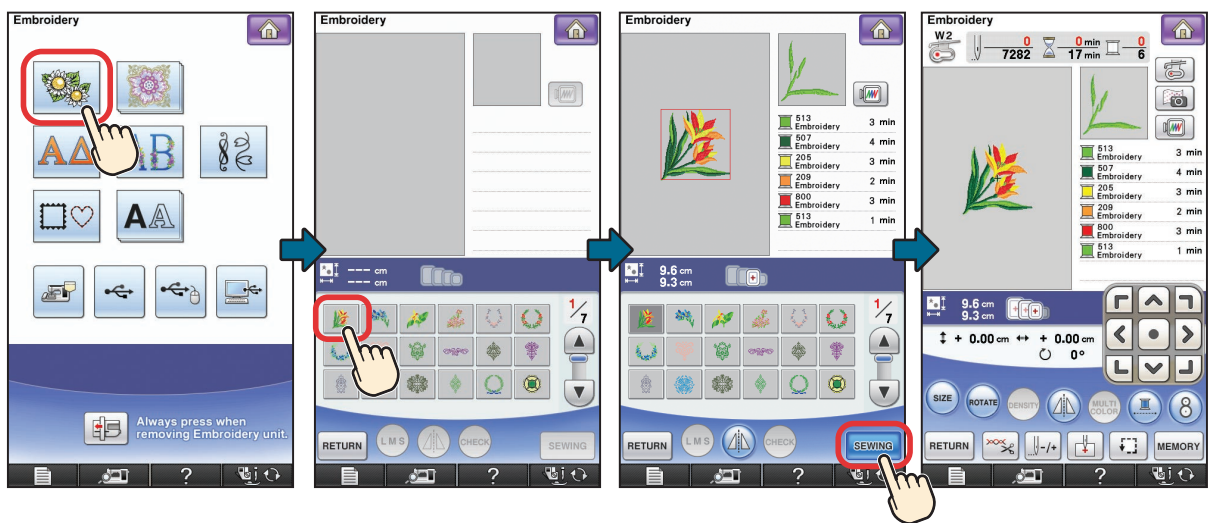

Embroidery Edit Patterns
 Borduurbewerkingspatronen

Editieren von Stickmustern
 Schemi di modifica ricamo

Motifs de modification de broderie
 Patrones de edición de bordado

FLOWER



The sequence of screenshots illustrates the following steps:

- Pattern Selection:** The user selects the 'FLOWER' pattern from a grid of options.
- Thread Selection:** The user chooses a specific thread color (e.g., 513) from a list of options.
- Text Entry:** The user enters the letter 'A' into the text field.
- Letter Selection:** The user selects the letter 'F' from a keyboard.
- Size Adjustment:** The user adjusts the size of the letter 'F' using the size control buttons.
- Start Sewing:** The user presses the 'SEWING' button to begin the embroidery process.

Selecting Stitch Patterns
 Wahl des Nähmusters
 Sélection des configurations de point
 Kiezen van de steekpatronen
 Selezione degli schemi punto
 Selección de tipos de puntada

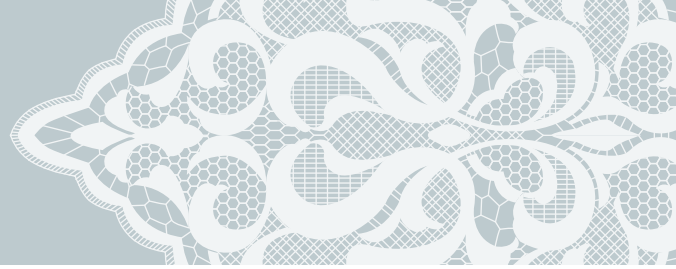

Others

Sonstiges

Autres

Overige

Altro

Otros

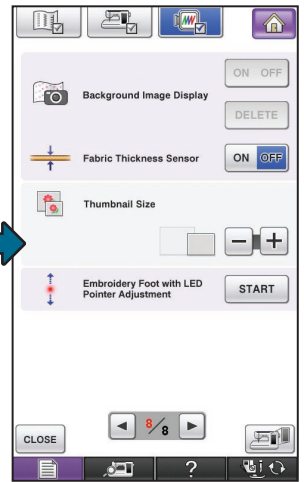
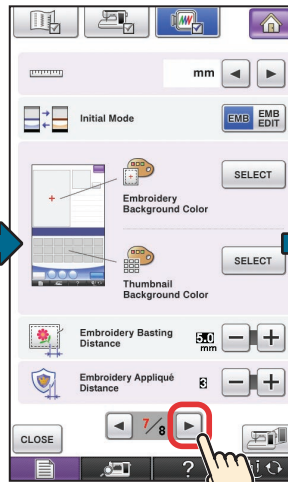
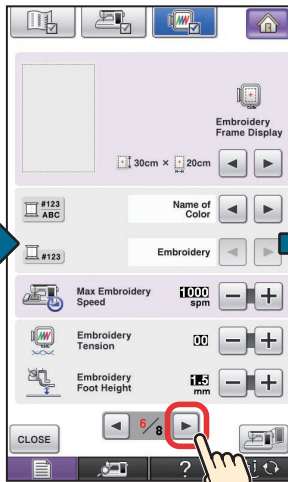
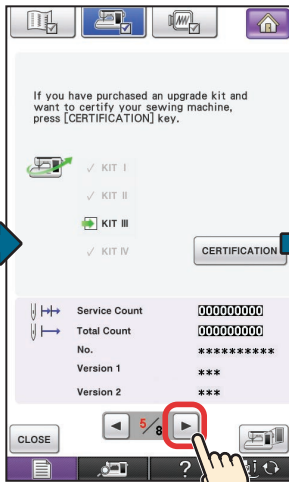
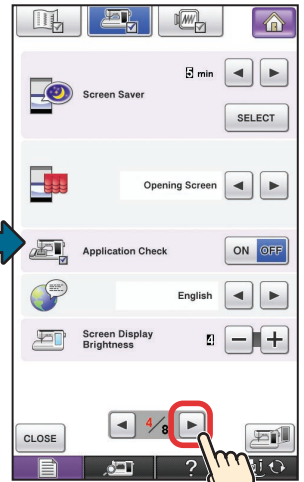
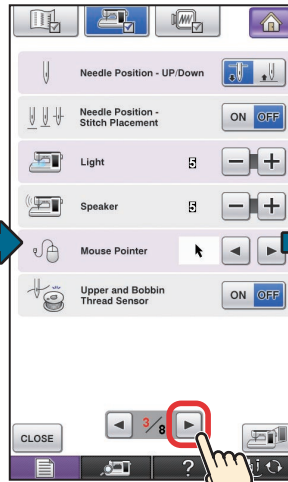
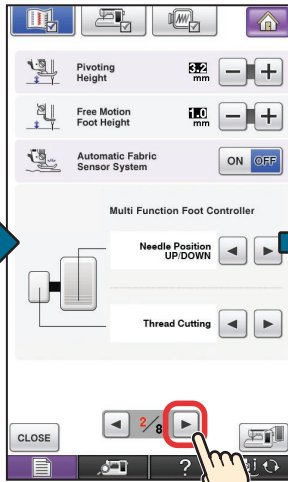
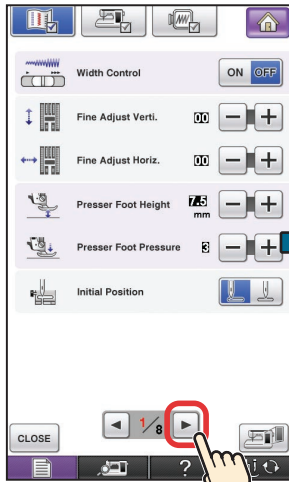

Summary of Stitch Patterns

Sommaire des motifs de point

Sommario degli schemi punto

Nähmuster-Übersicht

Overzicht van de steekpatronen

Resumen de tipos de puntada

Utility Stitches

Naaisteken

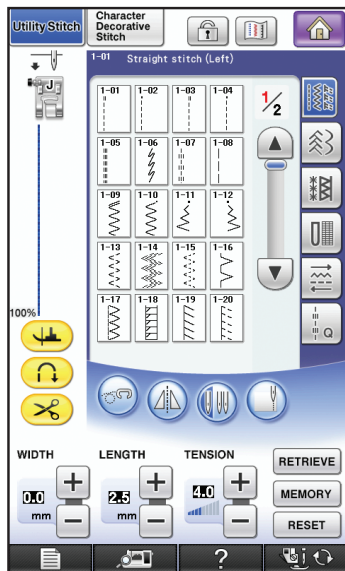

Nutzstiche

Punti utili

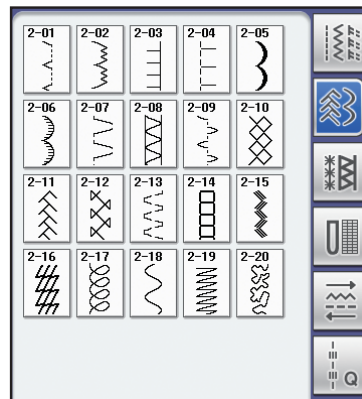
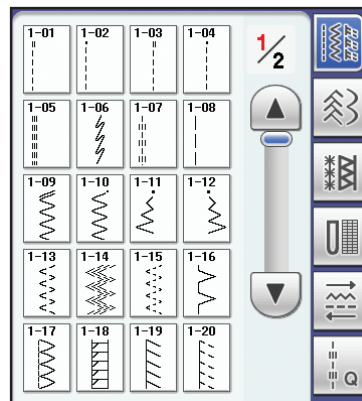

Points utilitaires

Puntadas utiles

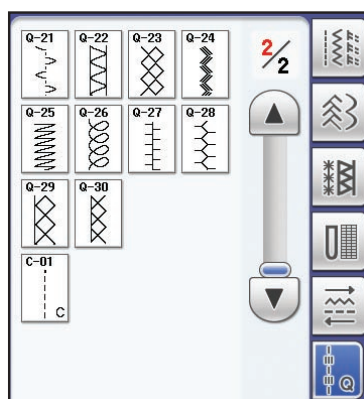
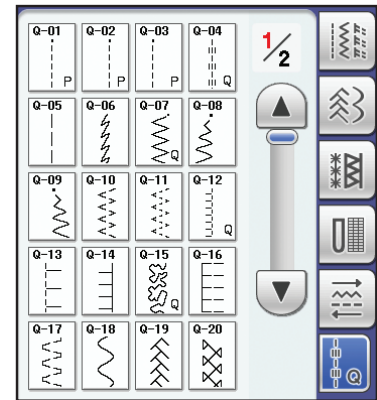
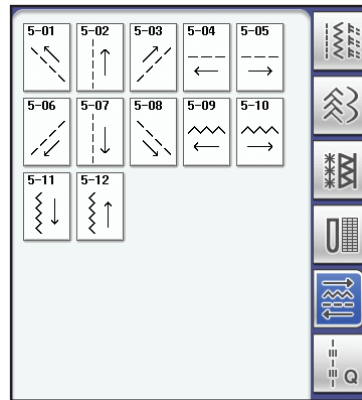
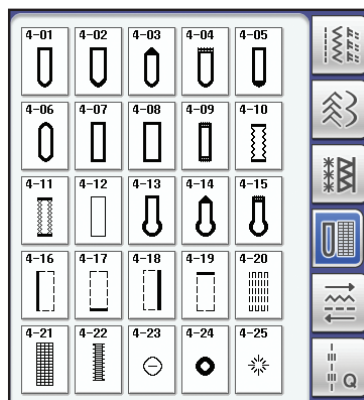
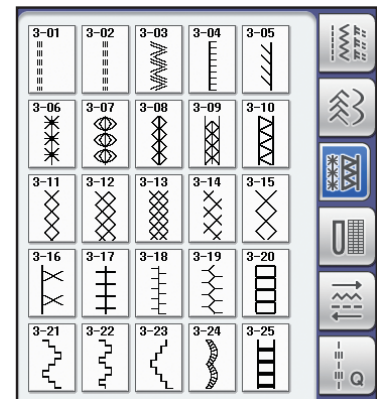
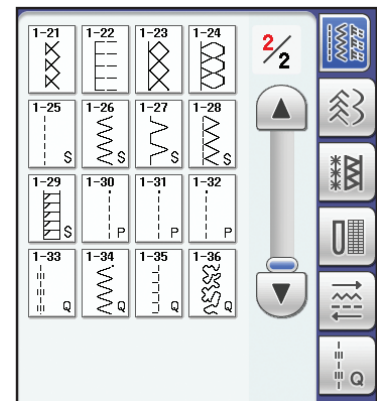

- * The stitch "C-01" is to be used with the optional couching foot.
- * Der Stich „C-01“ wird mit dem optionalen Plattstichfuß verwendet.
- * Le point « C-01 » doit être utilisé avec le pied pour la couture de cordons en option.
- * Gebruik steek "C-01" met de optionele koordvoet.
- * Il punto "C-01" è da utilizzare con il piedino per applicare cordoncini opzionale.
- * La puntada "C-01" debe utilizarse con el pie para coser cordones opcional.

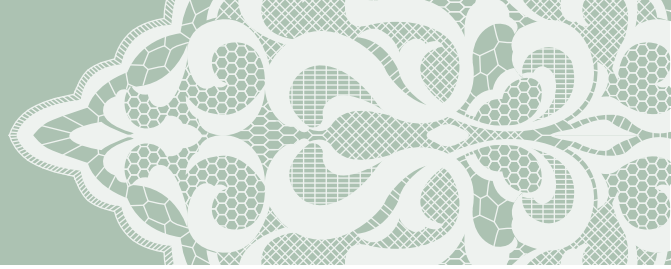

Character/Decorative Stitches

Buchstaben/Dekorative Stichmuster

Caractères/points décoratifs

Letter/decoratieve steken

Punti per caratteri/decorazioni

Puntadas de letras/decorativas

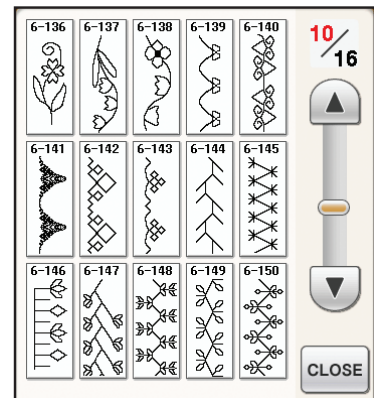
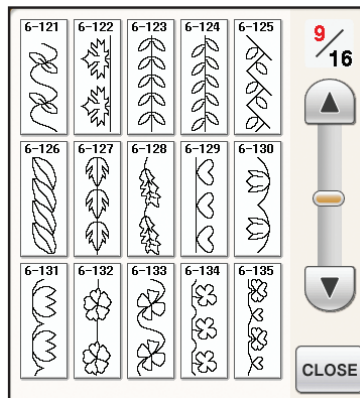
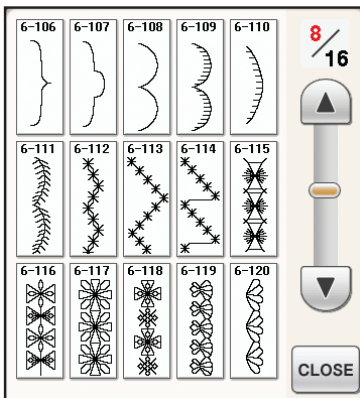
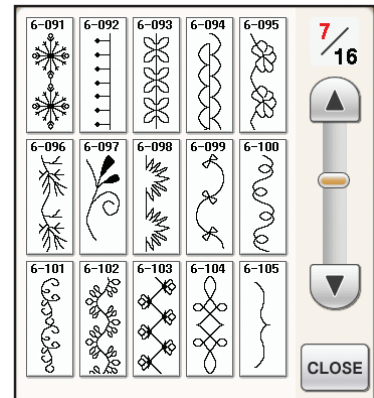
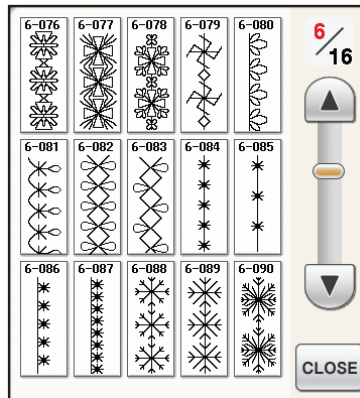
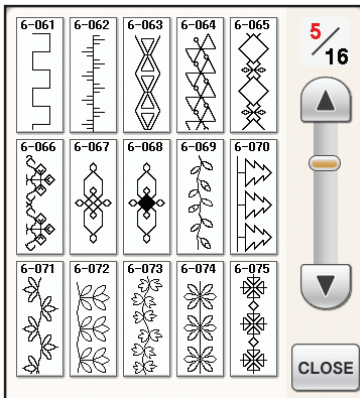
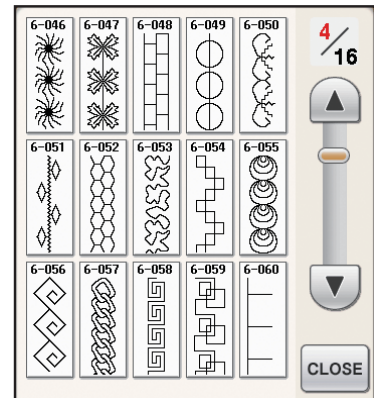
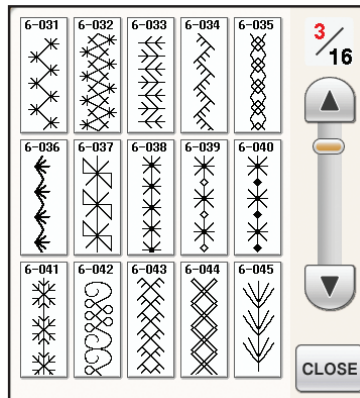
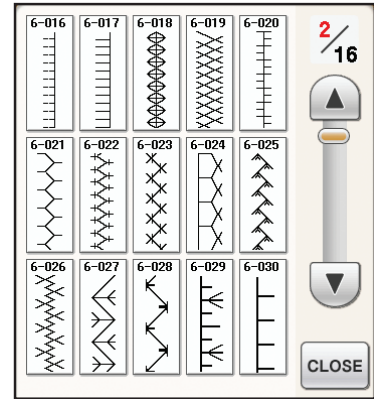
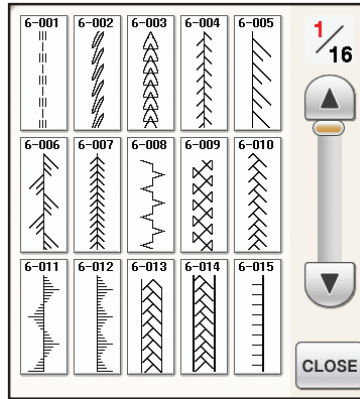
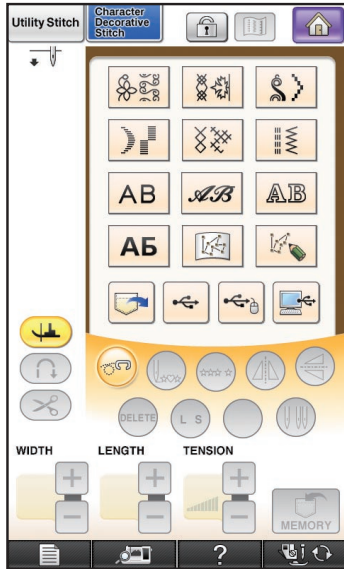

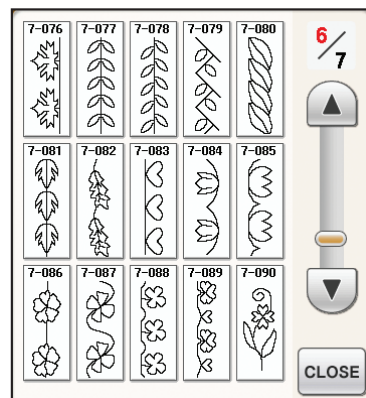
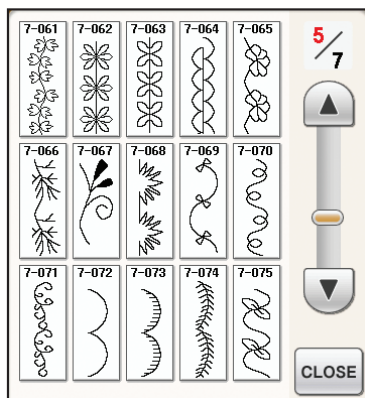
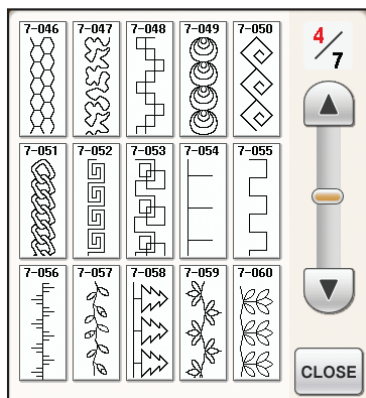
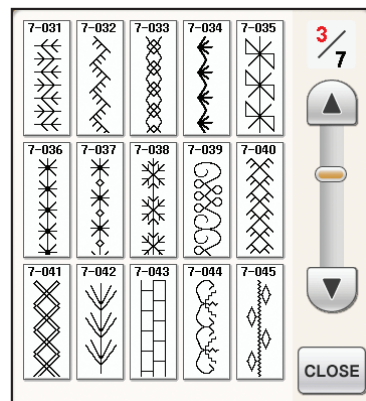
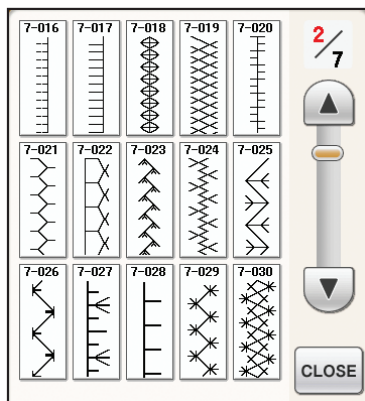
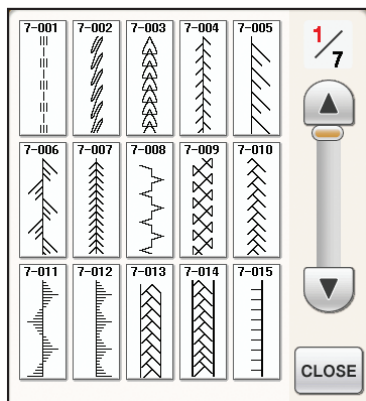
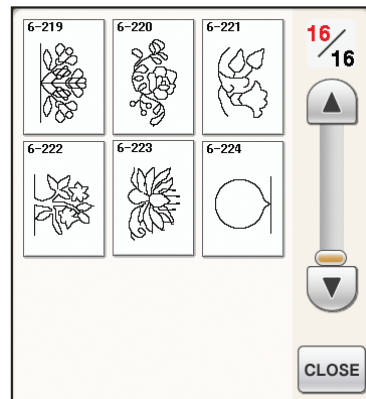
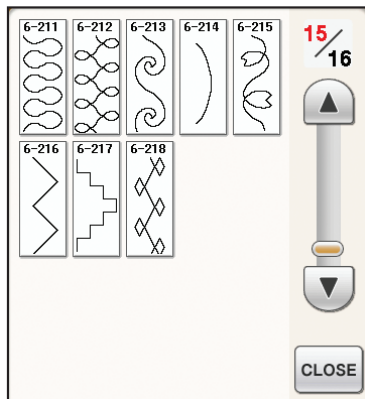
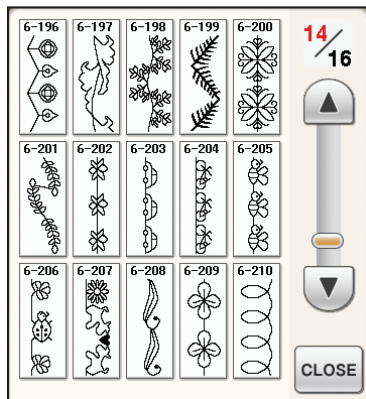
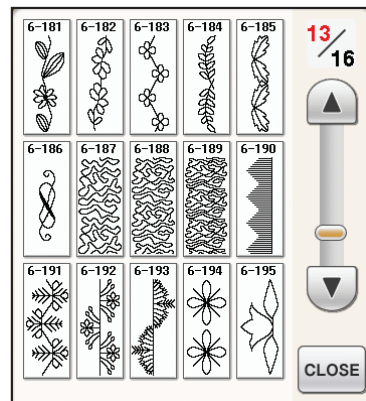
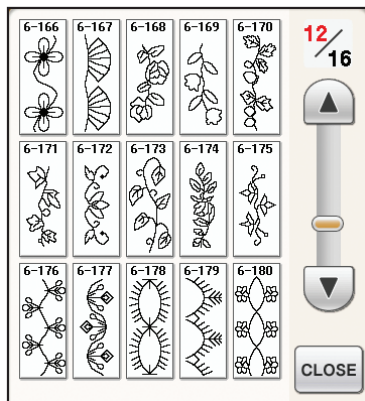
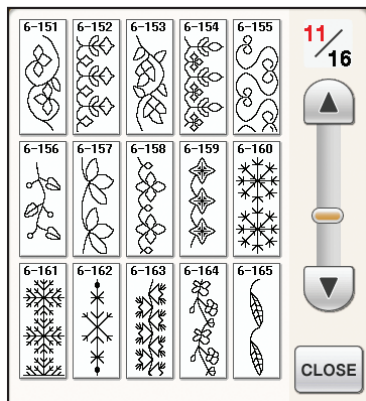

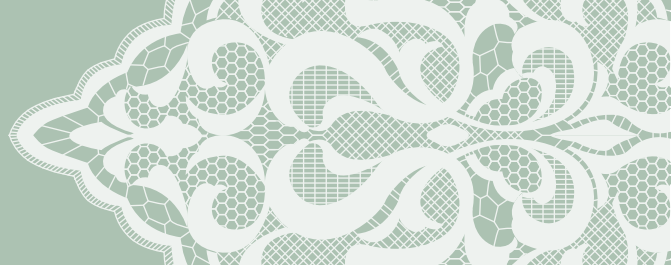

7-091	7-092	7-093	7-094	7 / 7
				CLOSE



8-01	8-02	8-03	8-04	8-05	1 / 5
8-06	8-07	8-08	8-09	8-10	
8-11	8-12	8-13	8-14	8-15	CLOSE

8-16	8-17	8-18	8-19	8-20	2 / 5
8-21	8-22	8-23	8-24	8-25	
8-26	8-27	8-28	8-29	8-30	CLOSE

8-31	8-32	8-33	8-34	8-35	3 / 5
8-36	8-37	8-38	8-39	8-40	
8-41	8-42	8-43	8-44	8-45	CLOSE

8-46	8-47	8-48	8-49	8-50	4 / 5
8-51	8-52	8-53	8-54	8-55	
8-56	8-57	8-58	8-59	8-60	CLOSE

8-61	8-62	8-63	8-64	8-65	5 / 5
8-66	8-67	8-68	8-69	8-70	
8-71	8-72				CLOSE



9-01	9-02	9-03	9-04	9-05	9-06
9-07	9-08	9-09	9-10	9-11	9-12
9-13	9-14	9-15	9-16	9-17	9-18
9-19	9-20				
		CLOSE			



10-01	10-02	10-03	10-04	10-05	10-06
10-07	10-08	10-09	10-10	10-11	10-12
10-13	10-14	10-15	10-16	10-17	
					CLOSE

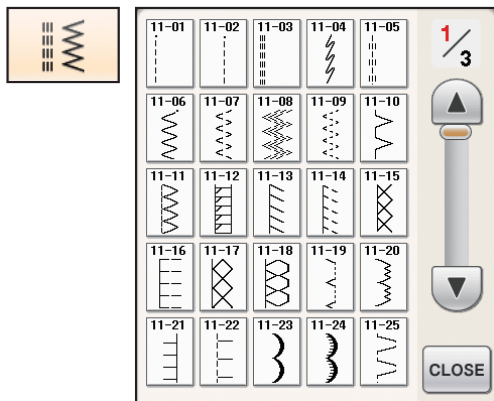

Panel 1: A selection panel for stitch patterns 11-01 to 11-25. It features a grid of 20 icons, a vertical slider, and a 'CLOSE' button. The icon '1' is selected, and the number '3' is shown in the top right corner.

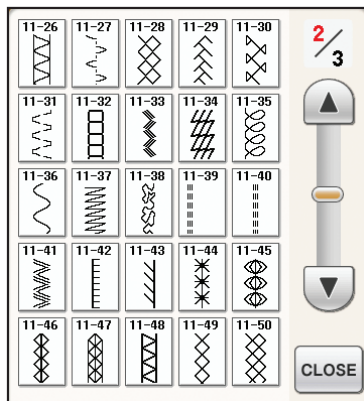

Panel 2: A selection panel for stitch patterns 11-26 to 11-50. It features a grid of 20 icons, a vertical slider, and a 'CLOSE' button. The icon '2' is selected, and the number '3' is shown in the top right corner.

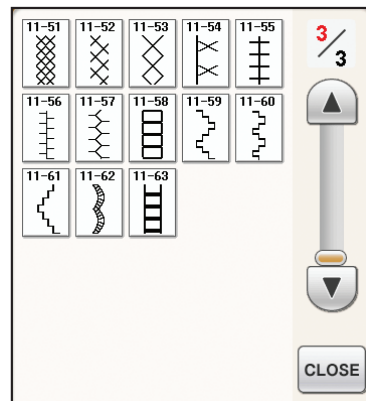

Panel 3: A selection panel for stitch patterns 11-51 to 11-63. It features a grid of 13 icons, a vertical slider, and a 'CLOSE' button. The icon '3' is selected, and the number '3' is shown in the top right corner.

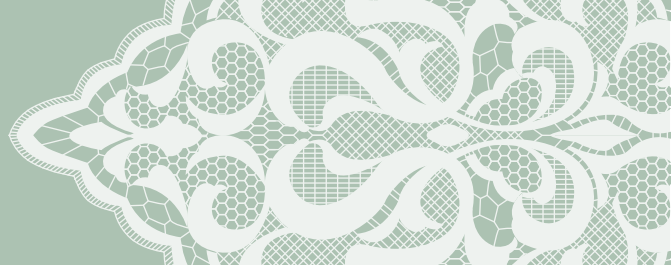

AB

A	B	C	D	E	ABC
F	G	H	I	J	abc
K	L	M	N	O	0-9..
P	Q	R	S	T	&?!
U	V	W	X	Y	ÄÄä
Z	'	_			ÖÖö
CLOSE					

α	β	γ	δ	ε	ABC
f	g	h	i	j	abc
k	l	m	n	o	0-9..
p	q	r	s	t	&?!
u	v	w	x	y	ÄÄä
z	'	_			ÖÖö
CLOSE					

0	1	2	3	4	ABC
5	6	7	8	9	abc
#	%	\$	£	€	0-9..
¥	-	+	×	÷	&?!
=	*	.	,	'	ÄÄä
_					ÖÖö
CLOSE					

&	?	!	@	<	ABC
>	()	[]	abc
/	\	~	:	;	0-9..
©	®	™	“	”	&?!
"	'	'	'	_	ÄÄä
					ÖÖö
CLOSE					

Â	Ä	Å	à	á	ABC
â	ä	å	ä	æ	abc
æ	Ç	ç	È	É	0-9..
Ê	Ë	è	é	ê	&?!
ë	Ï	ì	í	ï	ÄÄä
ñ	ñ	Í	í	_	ÖÖö
CLOSE					

Ô	Ö	Ø	ò	ó	ABC
ô	ö	ø	û	ü	abc
ù	ú	û	ü	þ	0-9..
ƒ	ß	ı	ı	ñ	&?!
Õ	õ	Œ	œ	ƒ	ÄÄä
ƒ	z	'	_		ÖÖö
CLOSE					

AB

<i>A</i>	<i>B</i>	<i>C</i>	<i>D</i>	<i>E</i>	ABC
<i>F</i>	<i>G</i>	<i>H</i>	<i>I</i>	<i>J</i>	abc
<i>K</i>	<i>L</i>	<i>M</i>	<i>N</i>	<i>O</i>	0-9..
<i>P</i>	<i>Q</i>	<i>R</i>	<i>S</i>	<i>T</i>	&?!
<i>U</i>	<i>V</i>	<i>W</i>	<i>X</i>	<i>Y</i>	ÄÄä
<i>Z</i>	'	_			ÖÖö
CLOSE					

<i>α</i>	<i>β</i>	<i>γ</i>	<i>δ</i>	<i>ε</i>	ABC
<i>f</i>	<i>g</i>	<i>h</i>	<i>i</i>	<i>j</i>	abc
<i>k</i>	<i>l</i>	<i>m</i>	<i>n</i>	<i>o</i>	0-9..
<i>p</i>	<i>q</i>	<i>r</i>	<i>s</i>	<i>t</i>	&?!
<i>u</i>	<i>v</i>	<i>w</i>	<i>x</i>	<i>y</i>	ÄÄä
<i>z</i>	'	_			ÖÖö
CLOSE					

<i>0</i>	<i>1</i>	<i>2</i>	<i>3</i>	<i>4</i>	ABC
<i>5</i>	<i>6</i>	<i>7</i>	<i>8</i>	<i>9</i>	abc
<i>#</i>	<i>%</i>	<i>\$</i>	<i>£</i>	<i>€</i>	0-9..
<i>¥</i>	<i>-</i>	<i>+</i>	<i>×</i>	<i>÷</i>	&?!
<i>=</i>	<i>*</i>	<i>.</i>	<i>,</i>	<i>'</i>	ÄÄä
<i>_</i>					ÖÖö
CLOSE					

&	?	!	@	<	ABC
>	()	[]	abc
/	\	~	:	;	0-9..
©	®	™	“	”	&?!
"	'	'	'	_	ÄÄä
					ÖÖö
CLOSE					

<i>Â</i>	<i>Ä</i>	<i>Å</i>	<i>à</i>	<i>á</i>	ABC
<i>â</i>	<i>ä</i>	<i>å</i>	<i>ä</i>	<i>æ</i>	abc
<i>æ</i>	<i>Ç</i>	<i>ç</i>	<i>È</i>	<i>É</i>	0-9..
<i>Ê</i>	<i>Ë</i>	<i>è</i>	<i>é</i>	<i>ê</i>	&?!
<i>ë</i>	<i>Ï</i>	<i>ì</i>	<i>í</i>	<i>ï</i>	ÄÄä
<i>ñ</i>	<i>ñ</i>	<i>Í</i>	<i>í</i>	_	ÖÖö
CLOSE					

<i>Ô</i>	<i>Ö</i>	<i>Ø</i>	<i>ò</i>	<i>ó</i>	ABC
<i>ô</i>	<i>ö</i>	<i>ø</i>	<i>û</i>	<i>ü</i>	abc
<i>ù</i>	<i>ú</i>	<i>û</i>	<i>ü</i>	<i>þ</i>	0-9..
<i>ƒ</i>	<i>ß</i>	<i>ı</i>	<i>ı</i>	<i>ñ</i>	&?!
<i>Õ</i>	<i>õ</i>	<i>Œ</i>	<i>œ</i>	<i>ƒ</i>	ÄÄä
<i>ƒ</i>	<i>z</i>	'	_		ÖÖö
CLOSE					

AB

A	B	C	D	E	ABC
F	G	H	I	J	abc
K	L	M	N	O	0-9..
P	Q	R	S	T	&?! ÄÄä
U	V	W	X	Y	ÖÖö
Z	'	_	CLOSE		

a	b	c	d	e	ABC
f	g	h	i	j	abc
k	l	m	n	o	0-9..
p	q	r	s	t	&?! ÄÄä
u	v	w	x	y	ÖÖö
z	'	_	CLOSE		

0	1	2	3	4	ABC
5	6	7	8	9	abc
#	%	\$	€	€	0-9..
¥	÷	+	x	÷	&?! ÄÄä
≡	*	o	,	'	ÖÖö
_	CLOSE				

&	?	!	⊙	<	ABC
>	()	[]	abc
/	\	~	:	;	0-9..
⊙	⊗	™	°	°	&?! ÄÄä
"	'	°	'	_	ÖÖö
CLOSE					

Â	Ä	Å	à	á	ABC
â	ä	å	ä	æ	abc
æ	Ç	ç	È	É	0-9..
Ê	Ë	è	é	ê	&?! ÄÄä
ë	ï	ì	í	ï	ÖÖö
ñ	ñ	í	í	_	CLOSE

Ô	Ö	Ø	ò	ó	ABC
ô	ö	ø	û	ü	abc
ù	ú	û	ü	Þ	0-9..
þ	ß	ı	ı	Ñ	&?! ÄÄä
Ó	ó	œ	œ	ƒ	ÖÖö
t'	z'	'	_	CLOSE	

AB

А	Б	В	Г	Д	АБВ
Е	Ё	Ж	З	И	чшщ
Й	К	Л	М	Н	абв
О	П	Р	С	Т	чшщ
У	Ф	Х	Ц	_	0-9..
CLOSE					

Ч	Ш	Щ	Ь	Ы	АБВ
ь	э	ю	я	Г	чшщ
е	і	ї	ў	Һ	абв
Һ	Ј	Јь	Һь	Ц	чшщ
Ғ	Ғ	Ғ	_	0-9..	
CLOSE					

а	б	в	г	д	АБВ
е	ё	ж	з	и	чшщ
й	к	л	м	н	абв
о	п	р	с	т	чшщ
у	ф	х	ц	_	0-9..
CLOSE					

ч	ш	щ	ь	ы	АБВ
ь	э	ю	я	Г	чшщ
е	і	ї	ў	Һ	абв
Һ	Ј	Јь	Һь	Ц	чшщ
Ғ	Ғ	Ғ	_	0-9..	
CLOSE					

0	1	2	3	4	АБВ
5	6	7	8	9	чшщ
-	.	,	&	?	абв
!	()	/	'	чшщ
_	CLOSE				0-9..

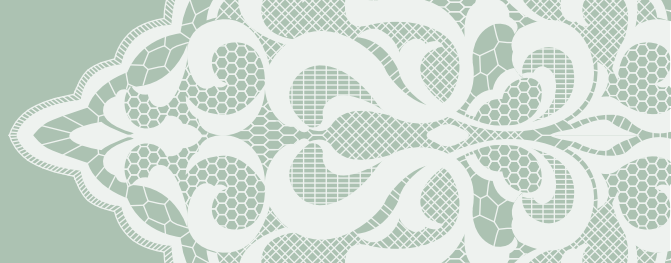

Embroidery Patterns

Borduurpatronen

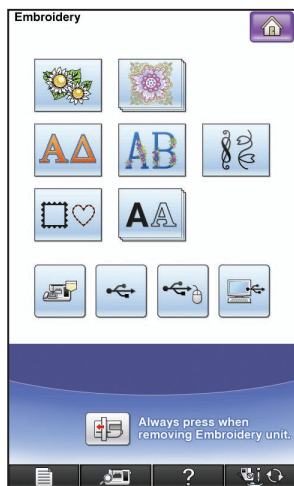

Stickmuster

Schemi di ricamo

Motifs de broderie

Patrones de bordado

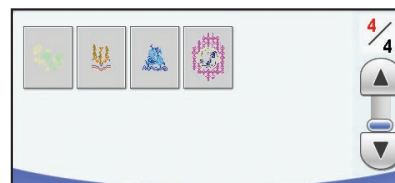
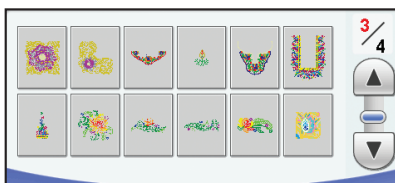
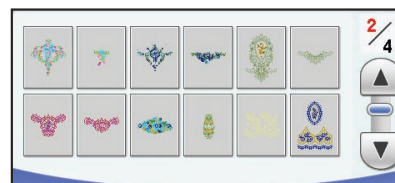
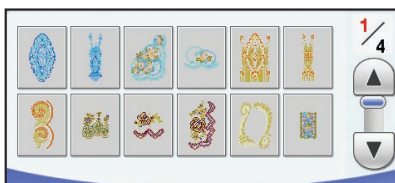
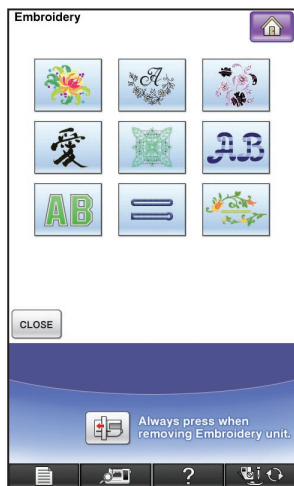
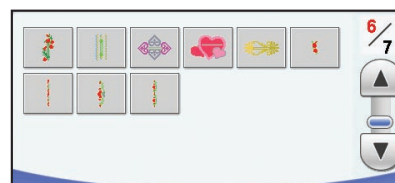

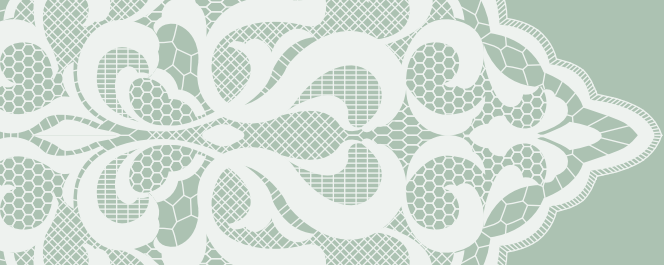

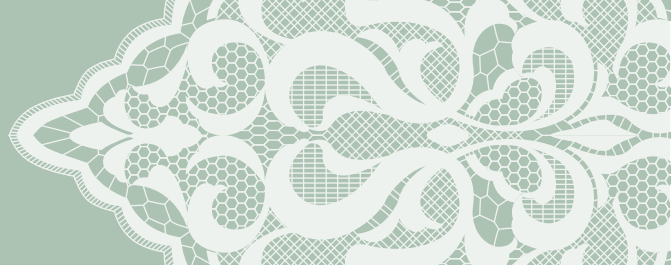

AB

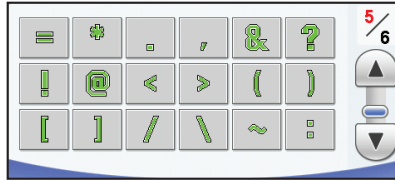
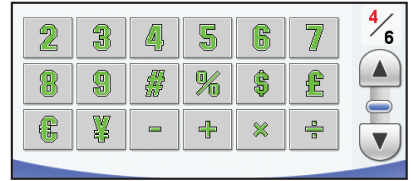
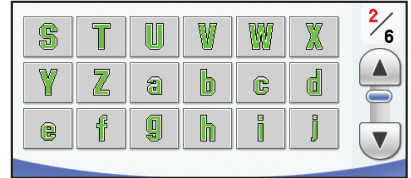

=

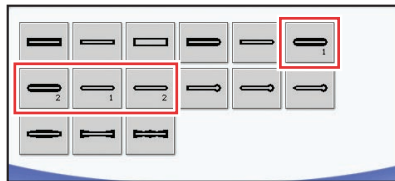

*

*

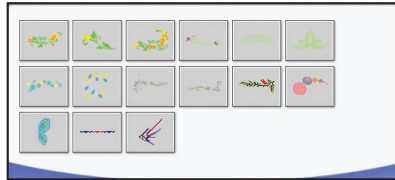
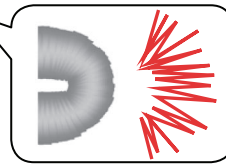
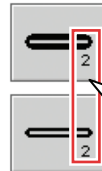
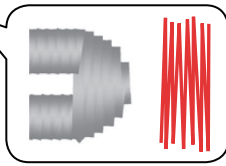
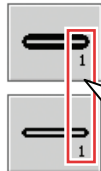

AΔ

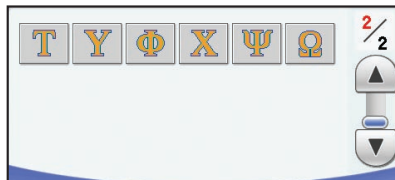

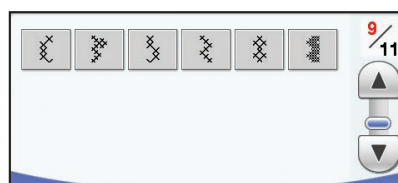
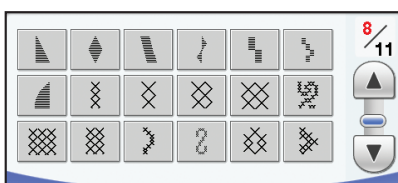
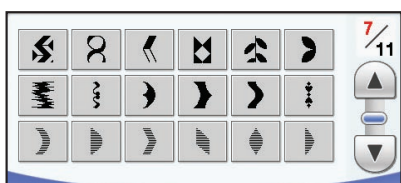
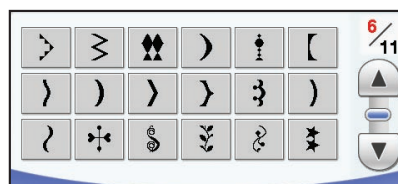
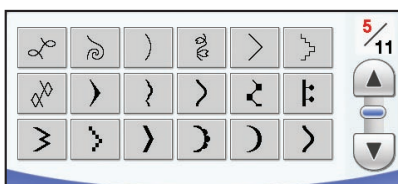
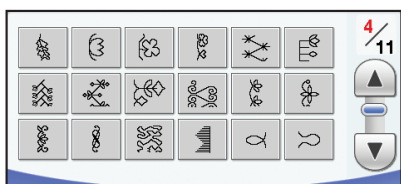
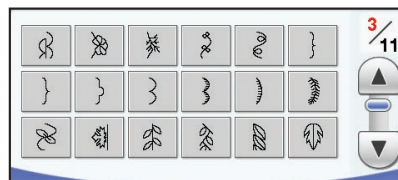
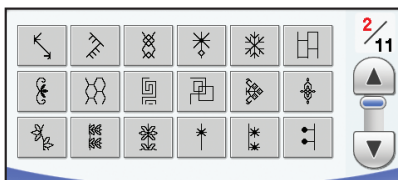
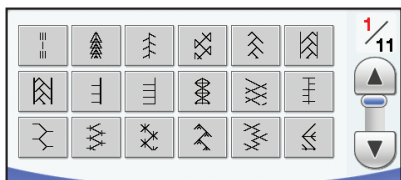
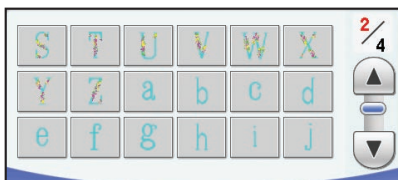

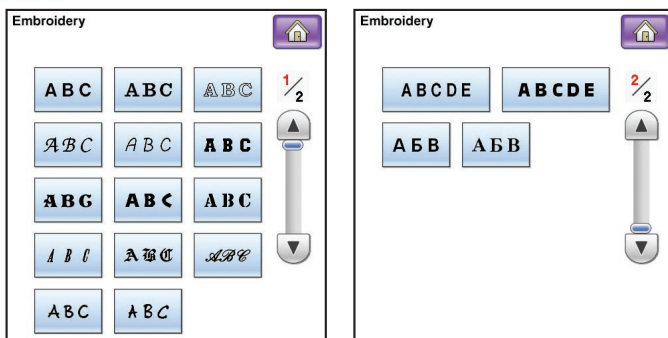
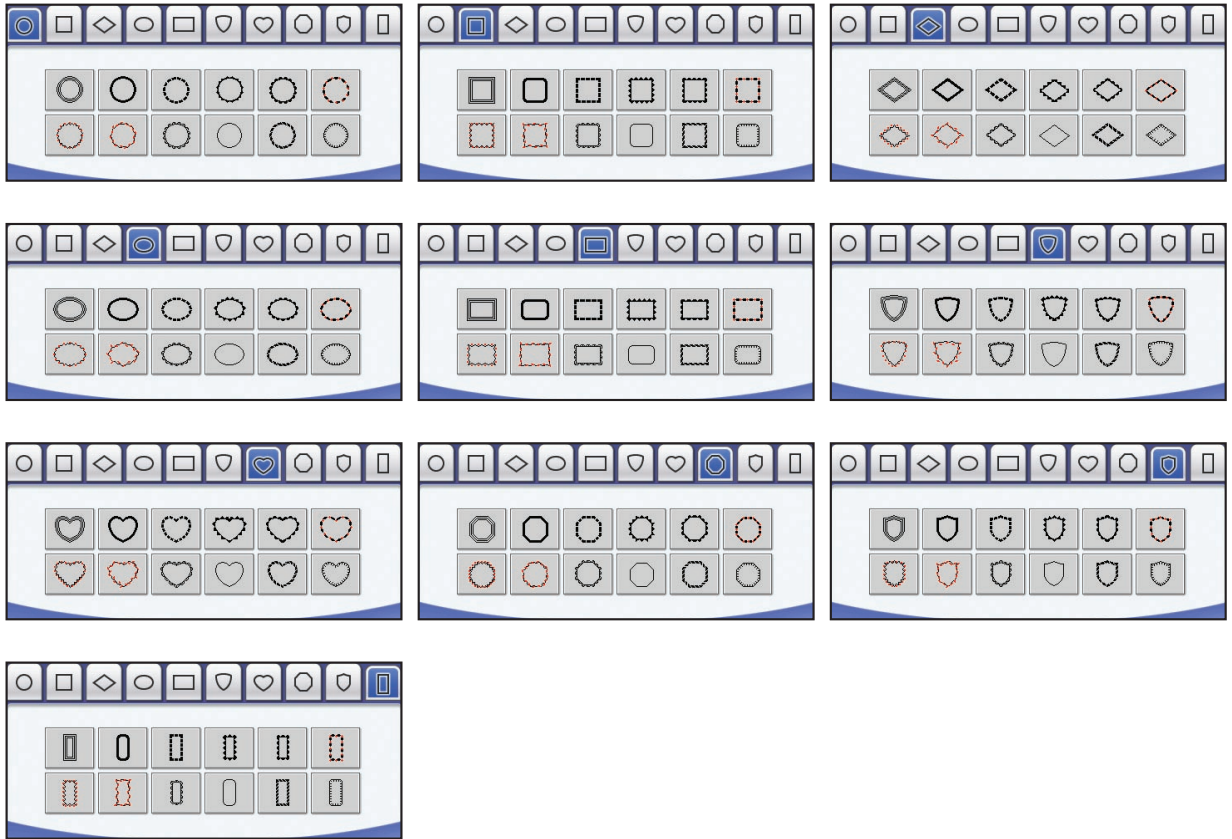
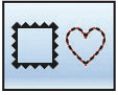
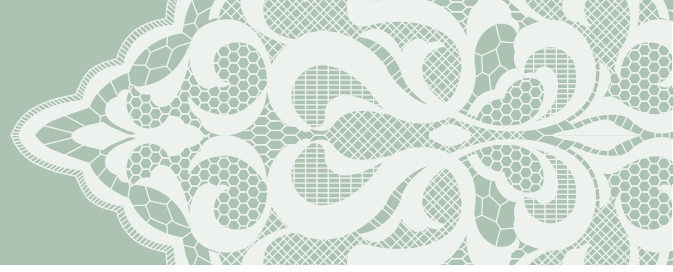



ABC

ABC	abc	0-9..	&?!	ÄÄä	ÖÖö	DELETE			
A	B	C	D	E	F	G	H	I	J
K	L	M	N	O	P	Q	R	S	T
U	V	W	X	Y	Z	'	_		

ABC	abc	0-9..	&?!	ÄÄä	ÖÖö	DELETE			
a	b	c	d	e	f	g	h	i	j
k	l	m	n	o	p	q	r	s	t
u	v	w	x	y	z	'	_		

ABC	abc	0-9..	&?!	ÄÄä	ÖÖö	DELETE			
0	1	2	3	4	5	6	7	8	9
#	%	\$	£	€	¥	-	+	x	÷
=	*	.	,	'	_				

ABC	abc	0-9..	&?!	ÄÄä	ÖÖö	DELETE			
&	?	!	@	<	>	()	[]
/	\	~	:	:	©	®	™	“	”
"	'	'	'	_					

ABC	abc	0-9..	&?!	ÄÄä	ÖÖö	DELETE			
Â	Ä	Å	à	á	â	ã	ä	å	Æ
æ	Ç	ç	È	É	Ê	Ë	è	é	ê
ë	Ï	ì	ï	Ð	Ñ	ñ	Í	í	_

ABC	abc	0-9..	&?!	ÄÄä	ÖÖö	DELETE			
Ô	Ö	Ø	ò	ó	ô	ö	ø	Û	Ü
ù	ú	û	ü	Þ	þ	ß	ì	í	Ñ
Õ	õ	Œ	œ	í	í	í	'	í	_

ABC

ABC	abc	0-9..	&?!	ÄÄä	ÖÖö	DELETE			
A	B	C	D	E	F	G	H	I	J
K	L	M	N	O	P	Q	R	S	T
U	V	W	X	Y	Z	'	_		

ABC	abc	0-9..	&?!	ÄÄä	ÖÖö	DELETE			
a	b	c	d	e	f	g	h	i	j
k	l	m	n	o	p	q	r	s	t
u	v	w	x	y	z	'	_		

ABC	abc	0-9..	&?!	ÄÄä	ÖÖö	DELETE			
0	1	2	3	4	5	6	7	8	9
#	%	\$	£	€	¥	-	+	x	÷
=	*	.	,	'	_				

ABC	abc	0-9..	&?!	ÄÄä	ÖÖö	DELETE			
&	?	!	@	<	>	()	[]
/	\	~	:	:	©	®	™	“	”
"	'	'	'	_					

ABC	abc	0-9..	&?!	ÄÄä	ÖÖö	DELETE			
Â	Ä	Å	à	á	â	ã	ä	å	Æ
æ	Ç	ç	È	É	Ê	Ë	è	é	ê
ë	Ï	ì	ï	Ð	Ñ	ñ	Í	í	_

ABC	abc	0-9..	&?!	ÄÄä	ÖÖö	DELETE			
Ô	Ö	Ø	ò	ó	ô	ö	ø	Û	Ü
ù	ú	û	ü	Þ	þ	ß	ì	í	Ñ
Õ	õ	Œ	œ	í	í	í	'	í	_

ABC

ABC	abc	0-9..	&?!	ÄÄä	ÖÖö	DELETE			
A	B	C	D	E	F	G	H	I	J
K	L	M	N	O	P	Q	R	S	T
U	V	W	X	Y	Z	'	_		

ABC	abc	0-9..	&?!	ÄÄä	ÖÖö	DELETE			
a	b	c	d	e	f	g	h	i	j
k	l	m	n	o	p	q	r	s	t
u	v	w	x	y	z	'	_		

ABC	abc	0-9..	&?!	ÄÄä	ÖÖö	DELETE			
0	1	2	3	4	5	6	7	8	9
#	%	\$	£	€	¥	-	+	x	÷
=	*	.	,	'	_				

ABC	abc	0-9..	&?!	ÄÄä	ÖÖö	DELETE			
&	?	!	@	<	>	()	[]
/	\	~	:	:	©	®	™	“	”
“	”	’	’	_					

ABC	abc	0-9..	&?!	ÄÄä	ÖÖö	DELETE			
Â	Ä	Å	à	á	â	ã	ä	å	Æ
æ	Ç	ç	È	É	Ê	Ë	è	é	ê
ë	Ï	ì	ï	Ð	Ñ	ñ	’	’	_

ABC	abc	0-9..	&?!	ÄÄä	ÖÖö	DELETE			
Ô	Ö	Ø	ò	ó	ô	ö	ø	Û	Ü
ù	ú	û	ü	Þ	þ	ß	ì	í	Ñ
Õ	õ	Œ	œ	í	í	í	'	í	_

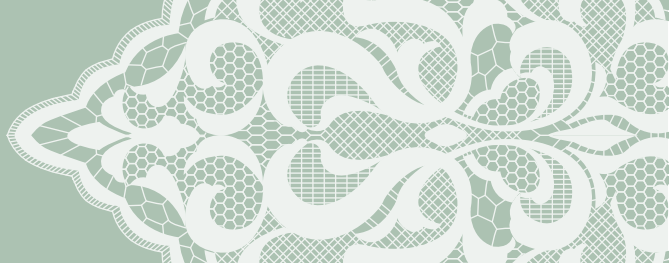

ABC

ABC	abc	0-9..	&?!	ÄÄä	ÖÖö	DELETE									
À	Á	Â	Ã	Ä	Å	Æ	Ç	Ð	É	Ê	Ë	Ì	Í	Î	Ï
Ë	Ì	Í	Î	Ï	Ð	É	Ê	Ë	Ì	Í	Î	Ï	Ð	É	Ê
U	V	W	X	Y	Z	'	_								

ABC	abc	0-9..	&?!	ÄÄä	ÖÖö	DELETE									
a	b	c	d	e	f	g	h	i	j						
κ	ι	μ	ν	ο	π	ρ	σ	τ							
u	v	w	x	y	z	'	_								

ABC	abc	0-9..	&?!	ÄÄä	ÖÖö	DELETE									
0	1	2	3	4	5	6	7	8	9						
#	%	\$	£	€	¥	-	+	x	÷						
=	*	.	,	'	_										

ABC	abc	0-9..	&?!	ÄÄä	ÖÖö	DELETE									
&	?	!	@	<	>	()	[]						
/	\	~	:	;	©	®	™	“	”						
"	'	·	'	_											

ABC	abc	0-9..	&?!	ÄÄä	ÖÖö	DELETE									
À	Á	Â	Ã	Ä	Å	Æ	Ç	Ð	É	Ê	Ë	Ì	Í	Î	Ï
æ	ç	ç	è	é	ê	ë	è	é	ê						
ë	ï	ì	í	î	ï	ð	ñ	ñ	'	_					

ABC	abc	0-9..	&?!	ÄÄä	ÖÖö	DELETE									
Ô	Õ	Ø	ò	ó	ô	ö	ø	Ù	Û						
ù	ú	û	ü	ƒ	þ	ß	ı	İ	Ñ						
Ö	ö	œ	æ	ı	ı	ı	'	_							

ABC

ABC	abc	0-9..	&?!	ÄÄä	ÖÖö	DELETE									
A	B	C	D	E	F	G	H	I	J						
K	L	M	N	O	P	Q	R	S	T						
U	V	W	X	Y	Z	'	_								

ABC	abc	0-9..	&?!	ÄÄä	ÖÖö	DELETE									
a	b	c	d	e	f	g	h	i	j						
k	l	m	n	o	p	q	r	s	t						
u	v	w	x	y	z	'	_								

ABC	abc	0-9..	&?!	ÄÄä	ÖÖö	DELETE									
0	1	2	3	4	5	6	7	8	9						
#	%	\$	£	€	¥	-	+	x	÷						
=	*	.	,	'	_										

ABC	abc	0-9..	&?!	ÄÄä	ÖÖö	DELETE									
&	?	!	@	<	>	()	[]						
/	\	~	:	;	©	®	™	“	”						
"	'	·	'	_											

ABC	abc	0-9..	&?!	ÄÄä	ÖÖö	DELETE									
À	Á	Â	Ã	Ä	Å	Æ	Ç	Ð	É	Ê	Ë	Ì	Í	Î	Ï
æ	ç	ç	è	é	ê	ë	è	é	ê						
ë	ï	ì	í	î	ï	ð	ñ	ñ	'	_					

ABC	abc	0-9..	&?!	ÄÄä	ÖÖö	DELETE									
Ô	Õ	Ø	ò	ó	ô	ö	ø	Ù	Û						
ù	ú	û	ü	ƒ	þ	ß	ı	İ	Ñ						
Ö	ö	œ	æ	ı	ı	ı	'	_							

ABC

ABC	abc	0-9..	&?!	ÄÄä	ÖÖö	DELETE									
A	B	C	D	E	F	G	H	I	J						
K	L	M	N	O	P	Q	R	S	T						
U	V	W	X	Y	Z	'	_								

ABC	abc	0-9..	&?!	ÄÄä	ÖÖö	DELETE									
a	b	c	d	e	f	g	h	i	j						
k	l	m	n	o	p	q	r	s	t						
u	v	w	x	y	z	'	_								

ABC	abc	0-9..	&?!	ÄÄä	ÖÖö	DELETE									
0	1	2	3	4	5	6	7	8	9						
#	%	\$	£	€	¥	-	+	x	÷						
=	*	.	,	'	_										

ABC	abc	0-9..	&?!	ÄÄä	ÖÖö	DELETE									
Œ	?	!	@	<	>	()	[]						
/	\	~	:	:	©	®	™	“	”						
"	'	·	'	_											

ABC	abc	0-9..	&?!	ÄÄä	ÖÖö	DELETE									
À	Á	Â	Ã	Ä	Å	Æ	Ç	Ð	É	Ê	Ë	Ì	Í	Î	Ï
æ	ç	ç	è	é	ê	ë	è	é	ê						
ë	ï	ì	í	î	ï	ð	ñ	ñ	'	_					

ABC	abc	0-9..	&?!	ÄÄä	ÖÖö	DELETE									
Ô	Õ	Ø	ò	ó	ô	ö	ø	Ù	Û						
ù	ú	û	ü	ƒ	þ	ß	ı	İ	Ñ						
Ö	ö	œ	æ	ı	ı	ı	'	_							



ABC

ABC	abc	0-9..	&?!	ÄÄä	ÖÖö	DELETE			
A	B	C	D	E	F	G	H	I	J
K	L	M	N	O	P	Q	R	S	T
U	V	W	X	Y	Z	'	_		

ABC	abc	0-9..	&?!	ÄÄä	ÖÖö	DELETE			
a	b	c	d	e	f	g	h	i	j
k	l	m	n	o	p	q	r	s	t
u	v	w	x	y	z	'	_		

ABC	abc	0-9..	&?!	ÄÄä	ÖÖö	DELETE			
0	1	2	3	4	5	6	7	8	9
#	%	\$	£	€	¥	-	+	x	÷
=	*	.	,	'	_				

ABC	abc	0-9..	&?!	ÄÄä	ÖÖö	DELETE			
&	?	!	@	<	>	()		
/	\	~	:	;	©	®	™	“	”
“	”	‘	’	_					

ABC	abc	0-9..	&?!	ÄÄä	ÖÖö	DELETE			
Â	Ä	Å	à	á	â	ã	ä	å	Æ
æ	Ç	ç	È	É	Ê	Ë	è	é	ê
ë	Ï	ì	ï	Ð	Ñ	ñ	'	_	

ABC	abc	0-9..	&?!	ÄÄä	ÖÖö	DELETE			
Ô	Ö	Ø	ò	ó	ô	ö	ø	Û	Ü
ù	ú	û	ü	Ɔ	Ɔ	Ɔ	ı	ı	Ñ
Ŏ	ó	œ	œ	ř	ř	ž	'	_	

ABC

ABC	abc	0-9..	&?!	ÄÄä	ÖÖö	DELETE			
A	B	C	D	E	F	G	H	I	J
K	L	M	N	O	P	Q	R	S	T
U	V	W	X	Y	Z	'	_		

ABC	abc	0-9..	&?!	ÄÄä	ÖÖö	DELETE			
a	b	c	d	e	f	g	h	i	j
k	l	m	n	o	p	q	r	s	t
u	v	w	x	y	z	'	_		

ABC	abc	0-9..	&?!	ÄÄä	ÖÖö	DELETE			
0	1	2	3	4	5	6	7	8	9
#	%	\$	£	€	¥	-	+	x	÷
=	*	.	,	'	_				

ABC	abc	0-9..	&?!	ÄÄä	ÖÖö	DELETE			
&	?	!	@	<	>	()		
/	\	~	:	;	©	®	™	“	”
“	”	‘	’	_					

ABC	abc	0-9..	&?!	ÄÄä	ÖÖö	DELETE			
Â	Ä	Å	à	á	â	ã	ä	å	Æ
æ	Ç	ç	È	É	Ê	Ë	è	é	ê
ë	Ï	ì	ï	Ð	Ñ	ñ	'	_	

ABC	abc	0-9..	&?!	ÄÄä	ÖÖö	DELETE			
Ô	Ö	Ø	ò	ó	ô	ö	ø	Û	Ü
ù	ú	û	ü	Ɔ	Ɔ	Ɔ	ı	ı	Ñ
Ŏ	ó	œ	œ	ř	ř	ž	'	_	

ABC

ABC	abc	0-9..	&?!	ÄÄä	ÖÖö	DELETE			
A	B	C	D	E	F	G	H	I	J
K	L	M	N	O	P	Q	R	S	T
U	V	W	X	Y	Z	'	_		

ABC	abc	0-9..	&?!	ÄÄä	ÖÖö	DELETE			
a	b	c	d	e	f	g	h	i	j
k	l	m	n	o	p	q	r	s	t
u	v	w	x	y	z	'	_		

ABC	abc	0-9..	&?!	ÄÄä	ÖÖö	DELETE			
0	1	2	3	4	5	6	7	8	9
#	%	\$	£	€	¥	-	+	x	÷
=	*	.	,	'	_				

ABC	abc	0-9..	&?!	ÄÄä	ÖÖö	DELETE			
&	?	!	@	<	>	()		
/	\	~	:	;	©	®	™	“	”
“	”	‘	’	_					

ABC	abc	0-9..	&?!	ÄÄä	ÖÖö	DELETE			
Â	Ä	Å	à	á	â	ã	ä	å	Æ
æ	Ç	ç	È	É	Ê	Ë	è	é	ê
ë	Ï	ì	ï	Ð	Ñ	ñ	'	_	

ABC	abc	0-9..	&?!	ÄÄä	ÖÖö	DELETE			
Ô	Ö	Ø	ò	ó	ô	ö	ø	Û	Ü
ù	ú	û	ü	Ɔ	Ɔ	Ɔ	ı	ı	Ñ
Ŏ	ó	œ	œ	ř	ř	ž	'	_	

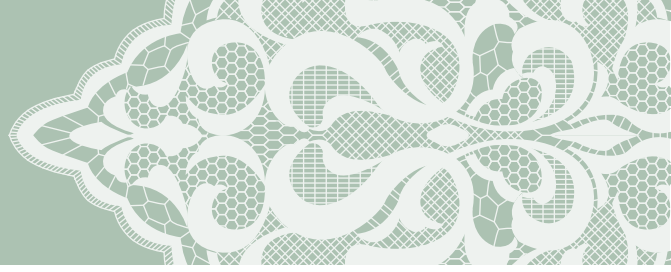

A B C

ABC	abc	0-9..	&?!	ÄÄä	ÖÖö	DELETE			
A	B	C	D	E	F	G	H	I	J
K	L	M	N	O	P	Q	R	S	T
U	V	W	X	Y	Z	'	_		

ABC	abc	0-9..	&?!	ÄÄä	ÖÖö	DELETE			
a	b	c	d	e	f	g	h	i	j
k	l	m	n	o	p	q	r	s	t
u	v	w	x	y	z	'	_		

ABC	abc	0-9..	&?!	ÄÄä	ÖÖö	DELETE			
0	1	2	3	4	5	6	7	8	9
#	%	\$	£	€	¥	-	+	x	÷
=	*	.	,	'	_				

ABC	abc	0-9..	&?!	ÄÄä	ÖÖö	DELETE			
&	?	!	@	<	>	()	[]
/	\	~	:	:	@	@	"	"	"
"	'	'	'	'	'	'	'	'	'

ABC	abc	0-9..	&?!	ÄÄä	ÖÖö	DELETE			
Á	Ä	À	à	á	â	ã	ä	å	Æ
æ	ç	ç	È	É	Ê	Ë	è	é	ê
ë	Ï	ì	ï	Ï	Ñ	ñ	'	'	'

ABC	abc	0-9..	&?!	ÄÄä	ÖÖö	DELETE			
Ô	Õ	Ø	ò	ó	ô	ö	ø	Ù	Û
ù	ú	û	ü	þ	ÿ	ı	İ	İ	Ń
Ń	õ	œ	œ	í	í	í	'	'	'

A B C

ABC	abc	0-9..	&?!	DELETE					
À	Á	Â	Ã	Ä	Å	Æ	Ç	È	É
Ê	Ë	Ì	Í	Î	Ï	Ð	Ñ	Ò	Ó
Ô	Õ	Ö	×	Ø	Ù	Ú	'	'	'

ABC	abc	0-9..	&?!	DELETE					
a	b	c	d	e	f	g	h	i	j
k	l	m	n	o	p	q	r	s	t
u	v	w	x	y	z	'	'	'	'

ABC	abc	0-9..	&?!	DELETE					
0	1	2	3	4	5	6	7	8	9
-	=	.	,	'	'	'	'	'	'

ABC	abc	0-9..	&?!	DELETE					
&	?	!	<	>	[]	/	\	~
:	:	"	"	'	'	'	'	'	'

A B C

ABC	abc	0-9..	&?!	ÄÄä	ÖÖö	DELETE			
À	Á	Â	Ã	Ä	Å	Æ	Ç	È	É
Ê	Ë	Ì	Í	Î	Ï	Ð	Ñ	Ò	Ó
Ô	Õ	Ö	×	Ø	Ù	Ú	'	'	'

ABC	abc	0-9..	&?!	ÄÄä	ÖÖö	DELETE			
a	b	c	d	e	f	g	h	i	j
k	l	m	n	o	p	q	r	s	t
u	v	w	x	y	z	'	'	'	'

ABC	abc	0-9..	&?!	ÄÄä	ÖÖö	DELETE			
0	1	2	3	4	5	6	7	8	9
-	.	,	'	'	'	'	'	'	'

ABC	abc	0-9..	&?!	ÄÄä	ÖÖö	DELETE			
&	?	!	@	()	/	'	'	'

ABC	abc	0-9..	&?!	ÄÄä	ÖÖö	DELETE			
À	Á	Â	à	á	ä	å	æ	ç	ø
ç	è	é	é	ë	ì	ñ	ñ	'	'

ABC	abc	0-9..	&?!	ÄÄä	ÖÖö	DELETE			
Ö	ø	à	ä	ø	Ù	ù	ü	ß	'



ABC

ABC	abc	0-9..	&?!	ÄÄä	ÖÖö	DELETE			
A	B	C	D	E	F	G	H	I	J
K	L	M	N	O	P	Q	R	S	T
U	V	W	X	Y	Z	'	_		

ABC	abc	0-9..	&?!	ÄÄä	ÖÖö	DELETE			
a	b	c	d	e	f	g	h	i	j
k	l	m	n	o	p	q	r	s	t
u	v	w	x	y	z	'	_		

ABC	abc	0-9..	&?!	ÄÄä	ÖÖö	DELETE			
0	1	2	3	4	5	6	7	8	9
#	%	\$	£	€	¥	-	+	x	÷
=	*	.	,	'	_				

ABC	abc	0-9..	&?!	ÄÄä	ÖÖö	DELETE			
&	?	!	@	<	>	()	[]
/	\	~	:	;	©	®	™	"	"
"	'	'	'	_					

ABC	abc	0-9..	&?!	ÄÄä	ÖÖö	DELETE			
Â	Ă	Ą	à	á	â	ã	ä	å	Æ
œ	Ç	ç	È	É	Ê	Ë	è	é	ê
ë	İ	ı	İ	Đ	Ñ	ñ	ı	ı	_

ABC	abc	0-9..	&?!	ÄÄä	ÖÖö	DELETE			
Ô	Ö	Ø	ò	ó	ô	ö	ø	Û	Ü
ù	ú	û	ü	Þ	þ	ß	ı	ı	Ń
Ö	ö	œ	œ	ı	ı	ı	'	'	_

ABC

ABC	abc	0-9..	&?!	ÄÄä	ÖÖö	DELETE			
A	B	C	D	E	F	G	H	I	J
K	L	M	N	O	P	Q	R	S	T
U	V	W	X	Y	Z	'	_		

ABC	abc	0-9..	&?!	ÄÄä	ÖÖö	DELETE			
a	b	c	d	e	f	g	h	i	j
k	l	m	n	o	p	q	r	s	t
u	v	w	x	y	z	'	_		

ABC	abc	0-9..	&?!	ÄÄä	ÖÖö	DELETE			
0	1	2	3	4	5	6	7	8	9
#	%	\$	£	€	¥	-	+	x	÷
=	*	.	,	'	_				

ABC	abc	0-9..	&?!	ÄÄä	ÖÖö	DELETE			
Ź	?	!	@	<	>	()	[]
/	\	~	:	;	©	®	™	"	"
"	'	'	'	_					

ABC	abc	0-9..	&?!	ÄÄä	ÖÖö	DELETE			
Â	Ă	Ą	à	á	â	ã	ä	å	Æ
œ	Ç	ç	È	É	Ê	Ë	è	é	ê
ë	İ	ı	İ	Đ	Ñ	ñ	ı	ı	_

ABC	abc	0-9..	&?!	ÄÄä	ÖÖö	DELETE			
Ô	Ö	Ø	ò	ó	ô	ö	ø	Û	Ü
ù	ú	û	ü	Þ	þ	ß	ı	ı	Ń
Ö	ö	œ	œ	ı	ı	ı	'	'	_

ABCDE

ABC	abc	0-9..	&?!	ÄÄä	ÖÖö	DELETE			
A	B	C	D	E	F	G	H	I	J
K	L	M	N	O	P	Q	R	S	T
U	V	W	X	Y	Z	'	_		

ABC	abc	0-9..	&?!	ÄÄä	ÖÖö	DELETE			
a	b	c	d	e	f	g	h	i	j
k	l	m	n	o	p	q	r	s	t
u	v	w	x	y	z	'	_		

ABC	abc	0-9..	&?!	ÄÄä	ÖÖö	DELETE			
0	1	2	3	4	5	6	7	8	9
#	%	\$	£	€	¥	-	+	x	÷
=	*	.	,	'	_				

ABC	abc	0-9..	&?!	ÄÄä	ÖÖö	DELETE			
&	?	!	@	<	>	()	[]
/	\	~	:	;	©	®	™	"	"
"	'	'	'	_					

ABC	abc	0-9..	&?!	ÄÄä	ÖÖö	DELETE			
Â	Ă	Ą	à	á	â	ã	ä	å	Æ
æ	Ç	ç	È	É	Ê	Ë	è	é	ê
ë	İ	ı	İ	Đ	Ñ	ñ	'	'	_

ABC	abc	0-9..	&?!	ÄÄä	ÖÖö	DELETE			
Ô	Ö	Ø	ò	ó	ô	ö	ø	Û	Ü
ù	ú	û	ü	Þ	þ	ß	ı	ı	Ń
Ö	ö	œ	œ	ı	ı	ı	'	'	_

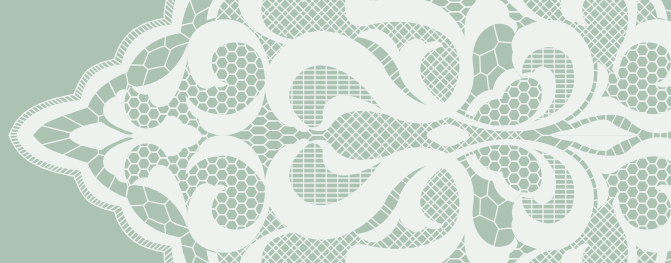

ABCDE

ABC abc 0-9.. &?! ÄÄä ÖÖö DELETE

A	B	C	D	E	F	G	H	I	J
K	L	M	N	O	P	Q	R	S	T
U	V	W	X	Y	Z	'	_		

ABC abc 0-9.. &?! ÄÄä ÖÖö DELETE

a	b	c	d	e	f	g	h	i	j
k	l	m	n	o	p	q	r	s	t
u	v	w	x	y	z	'	_		

ABC abc 0-9.. &?! ÄÄä ÖÖö DELETE

0	1	2	3	4	5	6	7	8	9
#	%	\$	£	€	¥	-	+	x	÷
=	*	.	,	'	_				

ABC abc 0-9.. &?! ÄÄä ÖÖö DELETE

&	?	!	@	<	>	()	[]
/	\	~	:	;	©	®	™	"	"
"	'	'	'	_					

ABC abc 0-9.. &?! ÄÄä ÖÖö DELETE

À	Á	Â	Ã	Ä	Å	Æ			
Ç	È	É	Ê	Ë	Ì	Í	Î	Ï	Ð
Ñ	Ò	Ó	Ô	Õ	Ö	Ø	Ù	Ú	Û

ABC abc 0-9.. &?! ÄÄä ÖÖö DELETE

Ô	Õ	Ø	ò	ó	ô	ö	ø	ù	ú
û	ü	ÿ	ƒ	ç	š	ž	'	_	
Š	Ž	ƒ	ç	š	ž	'	_		

АБВ

АБВ ЧШЩ абв чшщ 0-9?! DELETE

А	Б	В	Г	Д	Е	Ё	Ж	З	И
Й	К	Л	М	Н	О	П	Р	С	Т
У	Ф	Х	Ц	_					

АБВ ЧШЩ абв чшщ 0-9?! DELETE

Ч	Ш	Щ	Ъ	Ы	Ь	Э	Ю	Я	Г
Є	І	Ї	Ў	Ҁ	ҁ	҂	҃	҄	҅
҆	҇	҈	҉	Ҋ	ҋ	Ҍ	ҍ	Ҏ	ҏ

АБВ ЧШЩ абв чшщ 0-9?! DELETE

а	б	в	г	д	е	ё	ж	з	и
й	к	л	м	н	о	п	р	с	т
у	ф	х	ц	_					

АБВ ЧШЩ абв чшщ 0-9?! DELETE

ч	ш	щ	ъ	ы	ь	э	ю	я	г
є	і	ї	ў	Ҁ	ҁ	҂	҃	҄	҅
҆	҇	҈	҉	Ҋ	ҋ	Ҍ	ҍ	Ҏ	ҏ

АБВ ЧШЩ абв чшщ 0-9?! DELETE

0	1	2	3	4	5	6	7	8	9
-	.	,	&	?	!	()	/	'
_									

АБВ

АБВ ЧШЩ абв чшщ 0-9?! DELETE

А	Б	В	Г	Д	Е	Ё	Ж	З	И
Й	К	Л	М	Н	О	П	Р	С	Т
У	Ф	Х	Ц	_					

АБВ ЧШЩ абв чшщ 0-9?! DELETE

Ч	Ш	Щ	Ъ	Ы	Ь	Э	Ю	Я	Г
Є	І	Ї	Ў	Ҁ	ҁ	҂	҃	҄	҅
҆	҇	҈	҉	Ҋ	ҋ	Ҍ	ҍ	Ҏ	ҏ

АБВ ЧШЩ абв чшщ 0-9?! DELETE

а	б	в	г	д	е	ё	ж	з	и
й	к	л	м	н	о	п	р	с	т
у	ф	х	ц	_					

АБВ ЧШЩ абв чшщ 0-9?! DELETE

ч	ш	щ	ъ	ы	ь	э	ю	я	г
є	і	ї	ў	Ҁ	ҁ	҂	҃	҄	҅
҆	҇	҈	҉	Ҋ	ҋ	Ҍ	ҍ	Ҏ	ҏ

АБВ ЧШЩ абв чшщ 0-9?! DELETE

0	1	2	3	4	5	6	7	8	9
-	.	,	&	?	!	()	/	'
_									

Embroidery Pattern Color Change Table

Tableau de changement de couleur des motifs de broderie

Tabella di cambiamento colori degli schemi di ricamo

Stickmuster-Farbtabelle

Kleurwijzigingstabel voor de borduurpatronen

Tabla de cambio de color para patrones de bordado

Embroidery patterns
Borduurpatronen

Stickmuster
Schemi di ricamo

Motifs de broderie
Patrones de bordado



Design patterns

Muster entwerfen

Création de motifs

Ontwerp patronen

Creazione di disegni

Diseño de patrones



No.1 15 min

1	(513)
2	(507)
3	(205)
4	(209)
5	(800)
6	(513)

Time required for embroidering
Zeitaufwand beim Sticken
Durée requise pour broder
Tijd benodigd voor het borduren
Tempo di ricamo necessario
Tiempo requerido para el bordado

Embroidery thread color number
Stickgarn-Farbnummer
Numéro de couleur du fil de broderie
Kleurnummer borduurdraad
Numero colori filo per ricamo
Número de color del hilo de bordado

Embroidery size
Größe der Stickerei
Taille de la broderie
Borduurgrootte
Dimensioni del ricamo
Tecla de tamaño

Order to embroider
Stickreihenfolge
Séquence pour broder
Borduurvolgorde
Sequenza operazioni di ricamo
Orden para el bordador

Embroidery thread color
Stickgarnfarbe
Couleur du fil de broderie
Kleur borduurdraad
Colore filo ricamo
Color del hilo de bordado

↓ 9.6 cm ↔ 9.3 cm



No.10 3 min

1	(620)
---	-------

↓ 3.1 cm ↔ 9.5 cm



No.11 11 min

1	(707)
---	-------

↓ 9.6 cm ↔ 6.6 cm



No.2 14 min

1	(502)
2	(534)
3	(502)
4	(019)
5	(405)
6	(208)

↓ 9.3 cm ↔ 9.6 cm



No.6 3 min

1	(507)
2	(800)

↓ 5.3 cm ↔ 5.8 cm



No.12 9 min

1	(620)
---	-------

↓ 9.5 cm ↔ 6.7 cm



No.3 13 min

1	(507)
2	(513)
3	(205)
4	(209)
5	(030)

↓ 7.7 cm ↔ 9.1 cm



No.7 10 min

1	(502)
2	(010)
3	(513)
4	(507)
5	(019)
6	(405)

↓ 6.8 cm ↔ 8.6 cm



No.13 6 min

1	(070)
---	-------

↓ 9.6 cm ↔ 5.1 cm



No.4 15 min

1	(513)
2	(323)
3	(085)
4	(323)
5	(205)

↓ 9.3 cm ↔ 9.6 cm

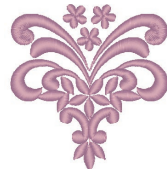

No.8 12 min

1	(079)
---	-------

↓ 9.0 cm ↔ 8.5 cm



No.14 7 min

1	(019)
---	-------

↓ 8.3 cm ↔ 9.6 cm



No.5 3 min

1	(070)
2	(079)

↓ 6.9 cm ↔ 6.3 cm



No.9 11 min

1	(507)
---	-------

↓ 9.5 cm ↔ 8.8 cm



No.15 7 min

1	(707)
---	-------

↓ 7.8 cm ↔ 8.7 cm



No.16 **3 min**

1	Green	(515)
---	-------	-------

↓ 7.5 cm ↔ 4.2 cm



No.22 **30 min**

1	Blue	(019)
2	Dark Blue	(405)
3	Yellow	(214)
4	Red	(800)
5	Black	(900)

↓ 14.2 cm ↔ 11.6 cm



No.26 **12 min**

1	Yellow	(334)
2	Orange	(354)
3	Light Green	(444)
4	Black	(747)
5	Yellow	(334)
6	Orange	(354)
7	Light Green	(444)
8	Black	(747)

↓ 10.0 cm ↔ 12.9 cm

Country



No.17 **4 min**

1	Green	(515)
2	Blue	(405)

↓ 6.6 cm ↔ 6.3 cm



No.23 **48 min**

1	Green	(513)
2	Dark Green	(515)
3	Yellow	(205)
4	Light Yellow	(010)
5	Orange	(208)
6	Pink	(085)
7	Light Pink	(810)
8	White	(001)
9	Dark Pink	(086)
10	Purple	(612)
11	Red	(800)

↓ 16.7 cm ↔ 12.3 cm



No.27 **38 min**

1	Green	(509)
2	Yellow	(206)

↓ 9.6 cm ↔ 9.6 cm



No.18 **14 min**

1	Green	(534)
2	Light Yellow	(010)
3	Yellow	(205)
4	Black	(900)

↓ 6.2 cm ↔ 6.3 cm



No.28 **24 min**

1	Green	(513)
---	-------	-------

↓ 9.5 cm ↔ 8.2 cm



No.19 **9 min**

1	Green	(515)
2	Blue	(405)
3	Red	(800)
4	Yellow	(328)

↓ 8.4 cm ↔ 8.8 cm



No.24 **23 min**

1	Yellow	(214)
2	Black	(058)
3	Black	(900)
4	Red	(800)
5	Blue	(070)
6	Green	(502)

↓ 16.6 cm ↔ 10.3 cm



No.29 **3 min**

1	Purple	(623)
2	Yellow	(370)
3	Purple	(623)

↓ 5.2 cm ↔ 6.1 cm

Country



No.20 **20 min**

1	Red	(800)
2	Blue	(019)
3	Black	(058)
4	Blue	(019)
5	Black	(058)
6	Blue	(019)
7	Black	(058)

↓ 8.9 cm ↔ 9.4 cm



No.25 **11 min**

1	Light Green	(444)
2	Green	(463)

↓ 13.2 cm ↔ 12.6 cm

Country

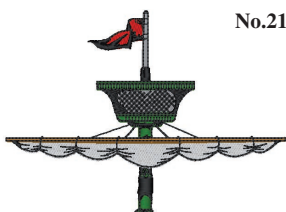

No.21 **16 min**

1	Red	(800)
2	Grey	(005)
3	Green	(515)
4	Black	(900)
5	White	(001)
6	Orange	(323)
7	Black	(900)

↓ 11.0 cm ↔ 15.2 cm



No.30 **11 min**

1	Pink	(122)
2	Black	(747)
3	Blue	(015)

↓ 9.1 cm ↔ 9.5 cm

Country

Embroidery Pattern Color Change Table
 Stickmuster-Farbtabelle
 Tableau de changement de couleur des motifs de broderie
 Kleurwijzigingstabel voor de borduurpatronen
 Tabella di cambiamento colori degli schemi di ricamo
 Tabla de cambio de color para patrones de bordado



No.31

2 min	
1	(575)
↕ 9.6 cm ↔ 3.9 cm	
Country	



● **No.36**

29 min	
1	(107)
2	(086)
↕ 20.4 cm ↔ 15.4 cm	



No.41

20 min	
1	(515)
2	(810)
3	(206)
4	(620)
↕ 10.1 cm ↔ 10.3 cm	



No.32

2 min	
1	(586)
↕ 6.3 cm ↔ 4.6 cm	
Country	



● **No.37**

27 min	
1	(405)
2	(420)
↕ 20.4 cm ↔ 15.4 cm	



No.33

2 min	
1	(015)
2	(575)
↕ 6.7 cm ↔ 6.6 cm	
Country	



● **No.38**

29 min	
1	(517)
2	(515)
↕ 20.4 cm ↔ 15.4 cm	



No.34

7 min	
1	(024)
↕ 8.8 cm ↔ 9.0 cm	
Country	



● **No.39**

28 min	
1	(007)
2	(405)
↕ 20.4 cm ↔ 15.4 cm	



No.35

6 min	
1	(623)
↕ 6.7 cm ↔ 7.4 cm	
Country	

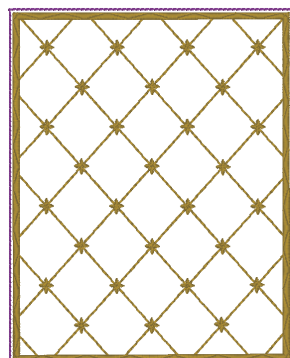

No.40

20 min	
1	(328)
2	(620)
↕ 19.4 cm ↔ 15.5 cm	

Patterns marked with ● have been rotated. Check your design placement prior to embroidering.
 Muster, die mit ● gekennzeichnet sind, wurden gedreht. Überprüfen Sie die Platzierung Ihres Designs, bevor Sie mit Sticken beginnen.
 Les motifs signalés par ● ont été pivotés. Vérifiez l'emplacement de votre motif avant de commencer à broder.
 Patronen die zijn gemarkeerd met ● zijn gedraaid. Controleer de plaats van uw ontwerp voordat u gaat borduren.
 I disegni contrassegnati dal simbolo ● appaiono ruotati. Prima di procedere al ricamo, verificare la posizione del disegno.
 Los patrones marcados con ● se han girado. Compruebe la colocación del diseño antes de bordar.

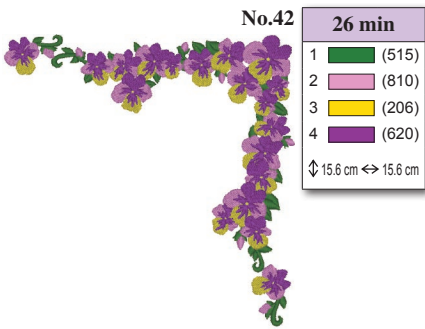

No.42 **26 min**

1	Green (515)
2	Pink (810)
3	Yellow (206)
4	Purple (620)

↓ 15.6 cm ↔ 15.6 cm



No.46 **14 min**

1	Green (509)
2	Blue (804)
3	Pink (085)

↓ 11.9 cm ↔ 6.4 cm



No.47 **9 min**

1	Light Blue (804)
2	Pink (810)
3	Dark Blue (607)
4	Light Blue (017)
5	Pink (085)
6	Pink (086)
7	Light Green (027)

↓ 6.3 cm ↔ 6.4 cm



★ No.51 **5 min**

1	Orange (335)
2	Orange (473)
3	Orange (473)
4	Orange (473)
5	Brown (255)
6	Orange (335)
7	Orange (335)
8	Orange (336)
9	White (000)
10	Brown (255)

↓ 6.8 cm ↔ 8.5 cm

Country

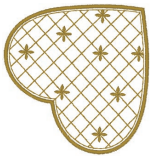

No.43 **6 min**

1	Gold (328)
---	------------

↓ 8.0 cm ↔ 7.7 cm

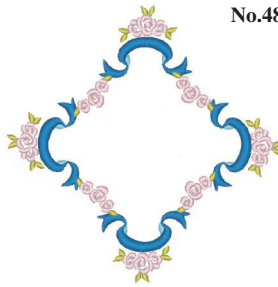

No.48 **11 min**

1	Light Blue (017)
2	Blue (019)
3	Yellow (027)
4	Pink (124)

↓ 14.9 cm ↔ 14.8 cm



★ No.52 **2 min**

1	Green (473)
2	Green (473)
3	Green (473)
4	Brown (255)

↓ 4.3 cm ↔ 6.7 cm

Country



No.53 **1 min**

1	Brown (255)
2	Gold (336)

↓ 2.5 cm ↔ 9.6 cm

Country



No.44 **16 min**

1	Pink (124)
2	Purple (612)
3	Light Blue (017)

↓ 21.7 cm ↔ 14.7 cm



No.49 **19 min**

1	Gold (328)
2	Yellow (214)
3	Blue (070)
4	Green (513)
5	Pink (124)
6	Yellow (214)

↓ 12.0 cm ↔ 9.5 cm



No.54 **6 min**

1	Light Blue (512)
2	Light Blue (003)
3	Dark Blue (564)

↓ 7.0 cm ↔ 4.1 cm

Country



No.55 **4 min**

1	Light Blue (003)
2	Light Blue (512)
3	Dark Blue (564)

↓ 4.0 cm ↔ 4.4 cm

Country



No.50 **11 min**

1	Pink (124)
2	Pink (085)
3	Pink (810)
4	Purple (612)
5	Green (513)
6	Yellow (214)

↓ 7.5 cm ↔ 7.5 cm



No.56 **3 min**

1	Blue (575)
---	------------

↓ 6.8 cm ↔ 6.9 cm

Country



No.45 **7 min**

1	Pink (085)
2	Light Blue (017)

↓ 15.0 cm ↔ 9.9 cm



No.57 **3 min**

1	Red (126)
---	-----------

↓ 8.7 cm ↔ 8.0 cm

Country

Embroidery Pattern Color Change Table
 Stickmuster-Farbtabelle
 Tableau de changement de couleur des motifs de broderie
 Kleurwijzigingstabel voor de borduurpatronen
 Tabella di cambiamento colori degli schemi di ricamo
 Tabla de cambio de color para patrones de bordado



No.58

13 min	
1	(334)
2	(224)
3	(334)
4	(512)
5	(224)

↕ 7.8 cm ↔ 17.6 cm

Country

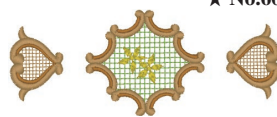

★ No.60

12 min	
1	(513)
2	(513)
3	(513)
4	(513)
5	(348)
6	(323)
7	(206)

↕ 5.7 cm ↔ 14.7 cm



No.62

5 min	
1	(126)
2	(206)
3	(513)
4	(337)

↕ 10.0 cm ↔ 3.3 cm



No.59

18 min	
1	(348)
2	(337)
3	(126)
4	(206)
5	(513)

↕ 14.0 cm ↔ 13.7 cm



★ No.61

21 min	
1	(348)
2	(348)
3	(348)
4	(348)
5	(323)
6	(513)
7	(126)
8	(209)
9	(030)
10	(206)

↕ 6.7 cm ↔ 14.4 cm



No.63

2 min	
1	(206)
2	(513)

↕ 3.3 cm ↔ 2.9 cm

Quilt patterns

Quiltpatronen

Bordüren

Disegni per trapuntatura

Motifs piqués

Patrones de acolchado

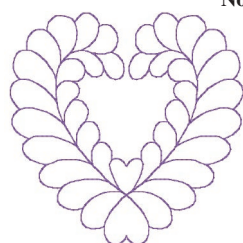

No.64

2 min	
1	(612)

↕ 12.5 cm ↔ 12.6 cm

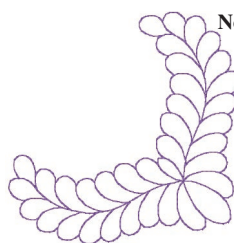

No.67

1 min	
1	(612)

↕ 12.6 cm ↔ 12.6 cm



No.69

1 min	
1	(612)

↕ 17.6 cm ↔ 5.7 cm

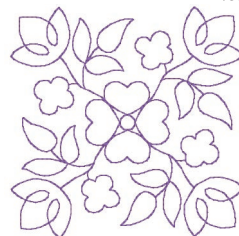

No.65

2 min	
1	(612)

↕ 12.5 cm ↔ 12.5 cm

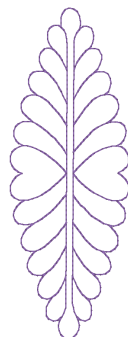

No.68

1 min	
1	(612)

↕ 17.6 cm ↔ 6.3 cm

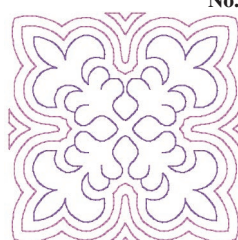

No.66

2 min	
1	(612)
2	(810)

↕ 12.6 cm ↔ 12.6 cm

- ★ Refer to the operation manual for the embroidery machine for details on how to embroider appliqués.
- ★ Weitere Hinweise zum Sticken von Applikationen finden Sie in der Bedienungsanleitung der Stickmaschine.
- ★ Reportez-vous au mode d'emploi de la machine à broder pour plus d'informations sur la broderie des appliqués.
- ★ In de bedieningshandleiding bij de borduurmachine leest u uitvoeriger hoe u applicaties borduurt.
- ★ Consultare il manuale di istruzioni della macchina da ricamo per i dettagli relativi al ricamo di appliqué.
- ★ Consulte el manual de instrucciones de la máquina de bordar si desea más información sobre cómo bordar apliques.

Decorative buttonhole patterns

Zierknopflochmuster

Motifs pour boutonnière décorative

Decoratieve knoopsgatpatronen

Disegni decorativi per asole

Costuras de ojales decorativas

Note : Touch  key in design selection screen to select one of the three sizes.

Hinweis : Wählen Sie mit der Taste  im Stickmustersauswahl-Bildschirm eine von drei Größen.



Remarque : Appuyez sur la touche  de l'écran de sélection des motifs pour sélectionner l'une des trois tailles.

Opmerking : Druk op  toets in het ontwerpkeuzescherf om een van de drie formaten te kiezen.

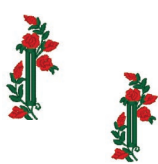

Nota : premere il tasto  nella schermata di selezione dei disegni per selezionare una delle tre dimensioni.

Nota : toque la tecla  en la pantalla de selección de diseños para seleccionar uno de los tres tamaños.







No.70		2 min
1		(507)
2		(800)
3		(507)
L:↕		5.6 cm ↔ 2.7 cm
M:↕		5.1 cm ↔ 2.6 cm
S:↕		4.6 cm ↔ 2.5 cm







No.72		4 min
1		(070)
2		(612)
3		(005)
L:↕		5.5 cm ↔ 7.4 cm
M:↕		5.5 cm ↔ 7.1 cm
S:↕		5.0 cm ↔ 6.0 cm

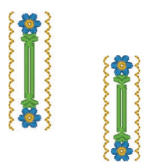





No.74		3 min
1		(214)
2		(208)
3		(328)
4		(214)
L:↕		2.8 cm ↔ 6.7 cm
M:↕		2.7 cm ↔ 6.4 cm
S:↕		2.5 cm ↔ 5.9 cm



No.71		2 min
1		(513)
2		(019)
3		(208)
4		(513)
L:↕		6.5 cm ↔ 2.2 cm
M:↕		5.9 cm ↔ 2.0 cm
S:↕		5.4 cm ↔ 2.0 cm



No.73		5 min
1		(086)
2		(085)
3		(070)
4		(086)
L:↕		3.8 cm ↔ 4.8 cm
M:↕		3.6 cm ↔ 4.6 cm
S:↕		3.3 cm ↔ 4.3 cm



Border patterns

Randmuster



Motifs de bordure

Randpatronen



Disegni con bordi

Costuras con bordes





No.75		1 min
1		(513)
2		(800)
↕		2.5 cm ↔ 1.4 cm





No.76		4 min
1		(513)
2		(800)
↕		15.1 cm ↔ 1.4 cm



No.77		2 min
1		(513)
2		(800)
3		(070)
↕		7.9 cm ↔ 2.3 cm



No.78		5 min
1		(513)
2		(800)
3		(070)
↕		15.8 cm ↔ 2.3 cm

Embroidery Pattern Color Change Table
 Stickmuster-Farbtabelle
 Tableau de changement de couleur des motifs de broderie
 Kleurwijzigingstabel voor de borduurpatronen
 Tabella di cambiamento colori degli schemi di ricamo
 Tabla de cambio de color para patrones de bordado

Designs using the Print and Stitch function

Motifs utilisant la fonction Imprimer et broder

Disegni che utilizzano la funzione Stampa & Ricama

Designs, die die Funktion Drucken und Sticken verwenden

Ontwerpen met de functie Print en Borduur

Diseños con la función Imprimir y coser



Background image
 Hintergrundbild
 Image d'arrière-plan
 Achtergrondafbeelding
 Immagine di sfondo
 Imagen de fondo



No.79

30 min	
1	(019)
2	(405)
3	(214)
4	(800)
5	(900)
↓ 14.2 cm ↔ 11.6 cm	

Embroidery pattern
 Stickmuster
 Motif de broderie
 Borduurpatroon
 Disegno da ricamo
 Patrón de bordado



No.80

12 min	
1	(334)
2	(354)
3	(444)
4	(747)
5	(334)
6	(354)
7	(444)
8	(747)
↓ 10.0 cm ↔ 12.9 cm	

Country



No.81

20 min	
1	(515)
2	(810)
3	(206)
4	(620)
↓ 10.1 cm ↔ 10.3 cm	



Refer to the operation manual for the sewing machine for details on how to embroider print and stitch patterns.

Weitere Einzelheiten zum Sticken der Druck- und Stickmuster finden Sie in der Bedienungsanleitung der Nähmaschine.

Reportez-vous au mode d'emploi de la machine à coudre pour de plus amples détails sur la broderie de motifs à imprimer et broder.

In de bedieningshandleiding bij de naaimachine vindt u meer bijzonderheden over het borduren met de functie Print en Borduur.

Fare riferimento al manuale d'istruzione della macchina da cucire per i dettagli su come ricamare i disegni stampa & ricama.

Para obtener más información sobre cómo bordar patrones de impresión y costura, consulte el manual de instrucciones de la máquina de coser.

↳ Brother “Exclusives”
Vintage designs

↳ “Exclusief” nostalgische
ontwerpen van Brother

↳ Brother-„Exklusiv“:
Klassische Designs

↳ Disegni Vintage
“Eclusivi” Brother

↳ Motifs classiques Brother
« exclusifs »

↳ Diseños de época
“exclusivos” de Brother

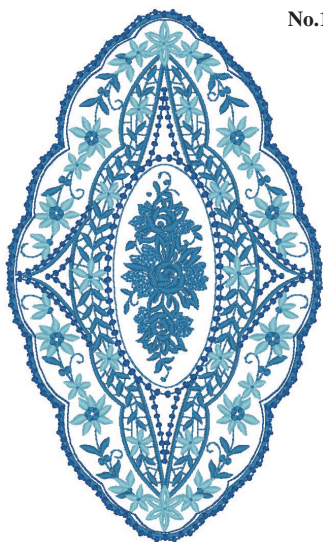

No.1 **58 min**

1	■	(019)
2	■	(017)
3	■	(420)
4	■	(019)
5	■	(420)

↓ 28.6 cm ↔ 17.0 cm



No.3 **55 min**

1	■	(328)
2	■	(214)
3	■	(019)
4	■	(330)
5	■	(348)
6	■	(079)
7	■	(328)
8	■	(019)
9	■	(017)
10	■	(330)
11	■	(348)
12	■	(079)
13	■	(330)
14	■	(348)
15	■	(019)
16	■	(079)
17	■	(214)
18	■	(019)
19	■	(206)

↓ 23.8 cm ↔ 18.4 cm



No.6 **18 min**

1	■	(348)
2	■	(214)
3	■	(339)
4	■	(843)

↓ 24.5 cm ↔ 6.6 cm



No.2 **27 min**

1	■	(019)
2	■	(420)
3	■	(017)
4	■	(019)
5	■	(017)
6	■	(420)

↓ 28.2 cm ↔ 8.5 cm



No.4 **10 min**

1	■	(328)
2	■	(019)
3	■	(017)
4	■	(330)
5	■	(348)
6	■	(079)
7	■	(214)
8	■	(019)
9	■	(206)

↓ 8.7 cm ↔ 13.1 cm



No.7 **11 min**

1	■	(214)
2	■	(339)

↓ 14.4 cm ↔ 6.6 cm



No.8 **16 min**

1	■	(406)
2	■	(323)
3	■	(330)
4	■	(323)
5	■	(330)
6	■	(406)
7	■	(542)
8	■	(328)

↓ 9.1 cm ↔ 9.3 cm



No.5 **47 min**

1	■	(348)
2	■	(214)
3	■	(339)
4	■	(843)
5	■	(348)
6	■	(214)
7	■	(339)
8	■	(843)

↓ 25.8 cm ↔ 16.3 cm



No.9 **14 min**

1	■	(405)
2	■	(348)
3	■	(107)
4	■	(058)
5	■	(517)
6	■	(405)
7	■	(107)
8	■	(328)
9	■	(307)
10	■	(348)
11	■	(058)
12	■	(405)

↓ 8.1 cm ↔ 9.7 cm

Embroidery Pattern Color Change Table
 Stickmuster-Farbtabelle
 Tableau de changement de couleur des motifs de broderie
 Kleurwijzigingstabel voor de borduurpatronen
 Tabella di cambiamento colori degli schemi di ricamo
 Tabla de cambio de color para patrones de bordado



No.10

31 min	
1	(405)
2	(348)
3	(107)
4	(058)
5	(517)
6	(405)
7	(107)
8	(328)
9	(348)
10	(307)
11	(348)
12	(058)
13	(405)

↓ 17.4 cm ↔ 9.7 cm



No.13

17 min	
1	(017)
2	(019)
3	(513)
4	(812)
5	(017)
6	(612)
7	(085)
8	(017)
9	(019)
10	(513)
11	(812)
12	(017)
13	(612)
14	(085)
15	(513)
16	(017)
17	(019)
18	(812)
19	(017)
20	(085)
21	(612)

↓ 13.3 cm ↔ 12.5 cm



No.17

23 min	
1	(005)
2	(517)
3	(843)
4	(348)
5	(323)
6	(079)
7	(707)
8	(817)
9	(707)
10	(005)
11	(817)
12	(079)

↓ 13.4 cm ↔ 9.3 cm



No.11

19 min	
1	(399)
2	(214)
3	(399)
4	(214)
5	(399)

↓ 26.5 cm ↔ 19.5 cm



No.14

2 min	
1	(513)
2	(812)
3	(017)
4	(085)
5	(612)

↓ 2.7 cm ↔ 2.6 cm



No.18

6 min	
1	(005)
2	(817)
3	(079)

↓ 4.0 cm ↔ 9.3 cm



No.19

21 min	
1	(333)
2	(515)
3	(843)
4	(607)
5	(620)
6	(612)
7	(620)

↓ 9.6 cm ↔ 14.0 cm

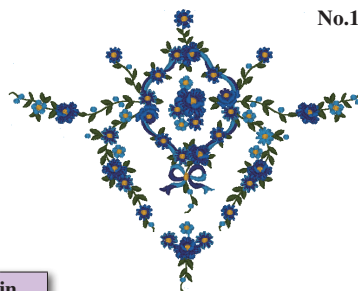

No.15

26 min	
1	(517)
2	(019)
3	(007)
4	(405)
5	(007)
6	(019)
7	(214)
8	(517)
9	(019)
10	(405)
11	(007)
12	(214)

↓ 15.2 cm ↔ 19.1 cm



No.20

10 min	
1	(612)
2	(333)
3	(612)
4	(620)

↓ 5.6 cm ↔ 12.3 cm



No.12

13 min	
1	(517)
2	(323)
3	(085)
4	(001)
5	(019)
6	(017)
7	(214)
8	(019)
9	(323)
10	(214)
11	(517)

↓ 8.7 cm ↔ 5.6 cm



No.16

7 min	
1	(019)
2	(405)
3	(007)
4	(517)
5	(405)
6	(019)
7	(007)
8	(214)

↓ 3.6 cm ↔ 9.3 cm



No.21

16 min	
1	(515)
2	(534)
3	(323)
4	(328)
5	(348)
6	(007)
7	(019)
8	(017)
9	(007)

↓ 4.8 cm ↔ 9.7 cm

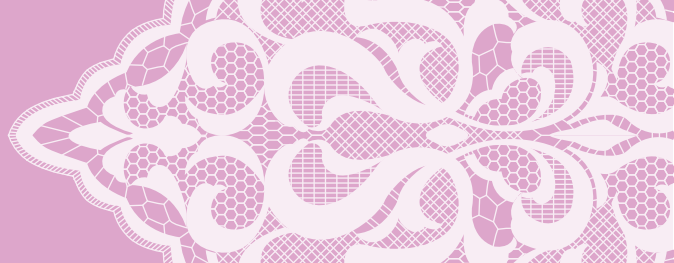

No.22

15 min	
1	(399)
2	(005)
3	(515)
4	(534)
5	(323)
6	(079)
7	(019)
8	(017)
9	(328)
10	(348)
11	(328)
12	(323)

↓ 10.1 cm ↔ 4.6 cm



No.26

46 min	
1	(328)
2	(070)
3	(843)
4	(620)
5	(613)

↓ 19.4 cm ↔ 19.6 cm



No.30

43 min	
1	(405)
2	(107)
3	(507)
4	(206)
5	(107)
6	(405)
7	(206)
8	(019)
9	(507)
10	(107)
11	(405)
12	(507)
13	(206)
14	(019)
15	(107)
16	(405)
17	(507)
18	(206)
19	(019)

↓ 22.9 cm ↔ 17.2 cm



No.23

9 min	
1	(843)

↓ 8.0 cm ↔ 10.4 cm



No.27

9 min	
1	(515)
2	(542)
3	(214)
4	(800)
5	(420)
6	(406)
7	(800)

↓ 5.9 cm ↔ 14.4 cm



No.24

23 min	
1	(348)
2	(405)
3	(406)
4	(348)
5	(405)
6	(406)

↓ 16.3 cm ↔ 11.9 cm



No.28

1 min	
1	(515)
2	(420)
3	(542)
4	(800)
5	(214)

↓ 2.1 cm ↔ 1.8 cm



No.31

6 min	
1	(107)
2	(507)
3	(405)
4	(206)
5	(019)
6	(405)
7	(107)
8	(507)
9	(206)

↓ 10.6 cm ↔ 5.4 cm

Guideline for the collar
 Hilfslinie für den Kragen
 Ligne de guidage pour le col
 Hulplijn voor de kraag
 Linea guida per il colletto
 Instrucciones para el cuello



No.29

15 min	
1	(515)
2	(542)
3	(214)
4	(800)
5	(420)
6	(406)
7	(515)
8	(542)
9	(214)
10	(800)
11	(406)
12	(420)
13	(515)
14	(542)
15	(214)
16	(800)
17	(406)
18	(420)
19	(800)
20	(406)
21	(399)

↓ 14.5 cm ↔ 14.8 cm



No.32

51 min	
1	(800)
2	(209)
3	(205)
4	(513)
5	(507)
6	(614)
7	(405)

↓ 22.6 cm ↔ 19.8 cm



No.25

78 min	
1	(070)
2	(843)
3	(328)
4	(620)
5	(613)

↓ 18.0 cm ↔ 18.7 cm



No.33

20 min	
1	(507)
2	(513)
3	(205)
4	(800)
5	(209)
6	(614)
7	(405)

↓ 23.0 cm ↔ 10.3 cm

Embroidery Pattern Color Change Table
 Stickmuster-Farbtabelle
 Tableau de changement de couleur des motifs de broderie
 Kleurwijzigingstabel voor de borduurpatronen
 Tabella di cambiamento colori degli schemi di ricamo
 Tabla de cambio de color para patrones de bordado

● No.34 **15 min**



1	■	(507)
2	■	(513)
3	■	(614)
4	■	(405)

⇅ 21.8 cm ⇔ 7.4 cm

No.37 **9 min**

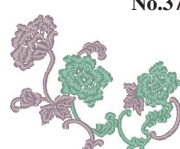

1	■	(399)
2	■	(542)
3	■	(399)

⇅ 7.9 cm ⇔ 9.5 cm

No.40 **23 min**

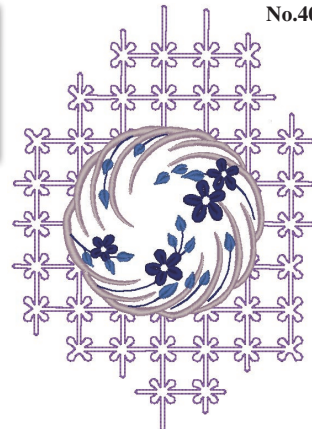

1	■	(612)
2	■	(399)
3	■	(007)
4	■	(070)

⇅ 23.0 cm ⇔ 16.3 cm

No.35 **7 min**



1	■	(205)
2	■	(800)
3	■	(209)
4	■	(507)
5	■	(513)
6	■	(614)
7	■	(405)

⇅ 4.1 cm ⇔ 9.2 cm

No.38 **5 min**



1	■	(420)
2	■	(030)
3	■	(337)
4	■	(330)
5	■	(420)
6	■	(307)

⇅ 9.0 cm ⇔ 5.8 cm

No.36 **17 min**



1	■	(085)
2	■	(502)
3	■	(019)
4	■	(208)
5	■	(085)
6	■	(017)
7	■	(405)
8	■	(502)
9	■	(001)
10	■	(019)
11	■	(208)

⇅ 7.1 cm ⇔ 7.0 cm

No.39 **11 min**



1	■	(019)
2	■	(405)

⇅ 9.6 cm ⇔ 9.9 cm

Patterns marked with ● have been rotated. Check your design placement prior to embroidering.
 Muster, die mit ● gekennzeichnet sind, wurden gedreht.
 Überprüfen Sie die Platzierung Ihres Designs, bevor Sie mit Sticken beginnen.
 Les motifs signalés par ● ont été pivotés. Vérifiez l'emplacement de votre motif avant de commencer à broder.
 Patronen die zijn gemarkeerd met ● zijn gedraaid.
 Controleer de plaats van uw ontwerp voordat u gaat borduren.
 I disegni contrassegnati dal simbolo ● appaiono ruotati.
 Prima di procedere al ricamo, verificare la posizione del disegno.
 Los patrones marcados con ● se han girado. Compruebe la colocación del diseño antes de bordar.

Brother "Exclusives"
Monogram designs

"Exclusief" monogramontwerpen van Brother

Brother-, „Exklusiv“:
Monogrammdesigns

Disegni monogramma
"Esclusivi" Brother

Motifs monogrammes
Brother « exclusifs »

Diseños de monogramas
"exclusivos" de Brother



No.1

3 min	
1	(000)
2	(461)
3	(442)
↓ 3.9 cm ↔ 4.6 cm	

Country



No.6

2 min	
1	(000)
2	(152)
3	(155)
↓ 3.8 cm ↔ 3.4 cm	

Country



No.11

2 min	
1	(000)
2	(604)
3	(623)
↓ 3.8 cm ↔ 5.1 cm	

Country



No.2

3 min	
1	(000)
2	(331)
3	(334)
↓ 3.9 cm ↔ 4.2 cm	

Country



No.7

3 min	
1	(000)
2	(461)
3	(442)
↓ 3.8 cm ↔ 3.5 cm	

Country



No.12

3 min	
1	(000)
2	(152)
3	(155)
↓ 3.8 cm ↔ 4.4 cm	

Country



No.3

3 min	
1	(000)
2	(020)
3	(012)
↓ 3.9 cm ↔ 3.7 cm	

Country



No.8

3 min	
1	(000)
2	(334)
↓ 3.8 cm ↔ 4.4 cm	

Country



No.13

3 min	
1	(000)
2	(461)
3	(442)
↓ 3.8 cm ↔ 5.9 cm	

Country



No.4

3 min	
1	(000)
2	(512)
3	(003)
↓ 3.9 cm ↔ 4.0 cm	

Country



No.9

2 min	
1	(000)
2	(020)
3	(012)
↓ 3.8 cm ↔ 3.3 cm	

Country



No.14

2 min	
1	(000)
2	(331)
3	(334)
↓ 3.6 cm ↔ 5.3 cm	

Country



No.5

2 min	
1	(000)
2	(604)
3	(623)
↓ 3.8 cm ↔ 3.2 cm	

Country



No.10

2 min	
1	(000)
2	(512)
3	(003)
↓ 4.3 cm ↔ 3.7 cm	

Country



No.15

2 min	
1	(000)
2	(020)
3	(012)
↓ 3.8 cm ↔ 3.1 cm	

Country

Embroidery Pattern Color Change Table
 Stickmuster-Farbtabelle
 Tableau de changement de couleur des motifs de broderie
 Kleurwijzigingstabel voor de borduurpatronen
 Tabella di cambiamento colori degli schemi di ricamo
 Tabla de cambio de color para patrones de bordado

No.16

2 min	
1	(000)
2	(003)

↓ 3.8 cm ↔ 4.0 cm

Country

No.22

2 min	
1	(000)
2	(512)
3	(003)

↓ 3.8 cm ↔ 4.7 cm

Country

No.27

13 min	
1	(000)
2	(370)
3	(335)

↓ 8.7 cm ↔ 12.4 cm

Country

No.17

3 min	
1	(000)
2	(604)
3	(623)

↓ 3.7 cm ↔ 3.0 cm

Country

No.23

3 min	
1	(000)
2	(512)
3	(623)

↓ 3.7 cm ↔ 5.0 cm

Country

No.28

16 min	
1	(000)
2	(003)
3	(604)

↓ 10.8 cm ↔ 12.8 cm

Country

No.18

3 min	
1	(000)
2	(152)
3	(155)

↓ 3.7 cm ↔ 4.7 cm

Country

No.24

3 min	
1	(000)
2	(152)
3	(155)

↓ 3.9 cm ↔ 5.3 cm

Country

No.29

13 min	
1	(000)
2	(623)
3	(604)

↓ 10.4 cm ↔ 12.3 cm

Country

No.19

2 min	
1	(000)
2	(461)
3	(442)

↓ 3.7 cm ↔ 3.3 cm

Country

No.25

2 min	
1	(000)
2	(442)
3	(461)

↓ 3.8 cm ↔ 4.3 cm

Country

No.30

13 min	
1	(000)
2	(442)
3	(025)

↓ 8.9 cm ↔ 11.9 cm

Country

No.20

2 min	
1	(000)
2	(331)
3	(334)

↓ 3.7 cm ↔ 4.3 cm

Country

No.26

2 min	
1	(000)
2	(334)
3	(331)

↓ 3.8 cm ↔ 3.7 cm

Country

No.21

2 min	
1	(000)
2	(012)
3	(020)

↓ 3.8 cm ↔ 4.1 cm

Country

Patterns No.1 - No.30, are designed by Yuki Pallis.
 Muster Nr. 1 - Nr. 30 wurden von Yuki Pallis entworfen.
 Les motifs 1 à 30 ont été conçus par Yuki Pallis.
 De patronen 1 - 30 zijn ontwikkeld door Yuki Pallis.
 I disegni dal N. 1 al N. 30 sono stati realizzati da Yuki Pallis.
 Los patrones del n° 1 al n° 30 han sido diseñados por Yuki Pallis.

Brother "Exclusives"
New European designs

"Exclusief" nieuwe
Europese ontwerpen van
Brother

Brother-,Exklusiv-:
Neue europäische Designs

Disegni novità europee
"Esclusivi" Brother

Motifs européens nouveauté
Brother « exclusifs »

Diseños de la Nueva
Europa "exclusivos" de
Brother



No.1 9 min

1	■	(900)
2	■	(030)

↓ 10.1 cm ↔ 19.6 cm



No.4 6 min

1	■	(001)
---	---	-------

↓ 19.3 cm ↔ 9.2 cm



No.2 8 min

1	■	(900)
2	■	(030)

↓ 15.9 cm ↔ 15.0 cm



No.7 17 min

1	■	(333)
2	■	(001)
3	■	(017)
4	■	(613)
5	■	(070)
6	■	(001)
7	■	(804)
8	■	(017)
9	■	(807)

↓ 10.6 cm ↔ 19.3 cm



No.5 86 min

1	■	(502)
2	■	(807)
3	■	(070)
4	■	(010)
5	■	(620)

↓ 28.0 cm ↔ 18.1 cm



No.3 29 min

1	■	(001)
2	■	(513)
3	■	(001)

↓ 25.8 cm ↔ 19.1 cm



No.8 15 min

1	■	(406)
2	■	(001)
3	■	(307)
4	■	(406)
5	■	(513)
6	■	(307)

↓ 14.8 cm ↔ 14.2 cm



No.6 19 min

1	■	(614)
2	■	(001)
3	■	(085)
4	■	(810)
5	■	(804)
6	■	(812)
7	■	(107)
8	■	(085)

↓ 15.5 cm ↔ 12.7 cm

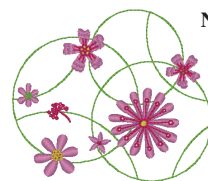

No.9 9 min

1	■	(513)
2	■	(206)
3	■	(001)
4	■	(085)
5	■	(107)
6	■	(206)
7	■	(513)

↓ 9.4 cm ↔ 11.0 cm

Embroidery Pattern Color Change Table
 Stickmuster-Farbtabelle
 Tableau de changement de couleur des motifs de broderie
 Kleurwijzigingstabel voor de borduurpatronen
 Tabella di cambiamento colori degli schemi di ricamo
 Tabla de cambio de color para patrones de bordado



★ No.10

7 min	
1	— × (513)
2	— × (513)
3	— × (513)
4	— (515)
5	— (001)

↓ 9.8 cm ↔ 8.8 cm



No.14

7 min	
1	— (007)
2	— (019)
3	— (007)
4	— (399)
5	— (005)
6	— (070)

↓ 7.2 cm ↔ 9.2 cm



No.18

30 min	
1	— (612)
2	— (086)
3	— (620)
4	— (001)
5	— (086)
6	— (900)
7	— (620)
8	— (612)
9	— (086)
10	— (620)
11	— (001)
12	— (900)
13	— (620)

↓ 15.4 cm ↔ 15.0 cm

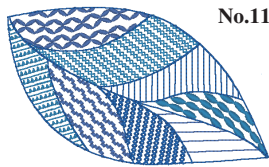

No.11

36 min	
1	— (019)
2	— (070)
3	— (405)
4	— (810)
5	— (612)
6	— (613)
7	— (502)
8	— (509)
9	— (515)

↓ 27.2 cm ↔ 14.0 cm

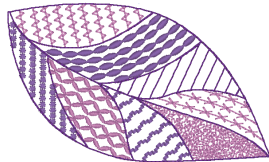

No.15

6 min	
1	— (323)
2	— (079)
3	— (348)
4	— (517)
5	— (348)
6	— (079)
7	— (323)

↓ 9.3 cm ↔ 5.9 cm



No.19

2 min	
1	— (620)
2	— (612)
3	— (086)

↓ 7.0 cm ↔ 2.3 cm

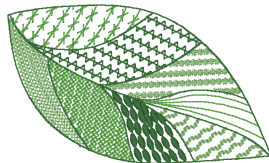

No.16

10 min	
1	— (348)
2	— (337)
3	— (323)
4	— (337)

↓ 8.3 cm ↔ 10.4 cm

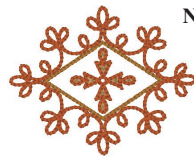

No.20

55 min	
1	— (620)
2	— (086)
3	— (001)
4	— (900)
5	— (620)
6	— (086)
7	— (612)
8	— (086)
9	— (001)
10	— (900)
11	— (620)
12	— (612)
13	— (086)
14	— (620)
15	— (900)
16	— (620)
17	— (086)
18	— (612)
19	— (086)
20	— (001)
21	— (900)
22	— (620)

↓ 27.6 cm ↔ 19.4 cm

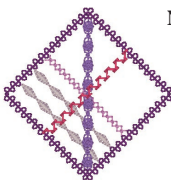

No.12

5 min	
1	— (810)
2	— (399)
3	— (612)
4	— (869)
5	— (807)

↓ 9.4 cm ↔ 9.1 cm



No.17

19 min	
1	— (869)
2	— (517)
3	— (620)
4	— (517)

↓ 27.9 cm ↔ 18.5 cm

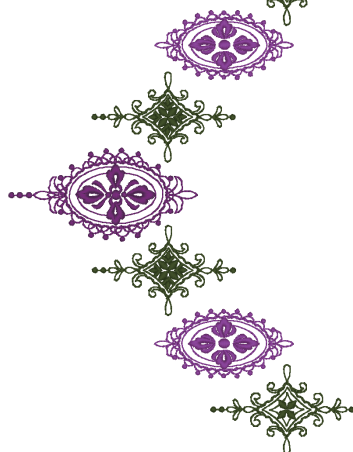

No.13

10 min	
1	— (017)
2	— (007)
3	— (085)
4	— (086)
5	— (107)
6	— (086)
7	— (107)

↓ 13.6 cm ↔ 6.5 cm

- ★ Refer to the operation manual for the embroidery machine for details on how to embroider appliqués.
- ★ Weitere Hinweise zum Sticken von Applikationen finden Sie in der Bedienungsanleitung der Stickmaschine.
- ★ Reportez-vous au mode d'emploi de la machine à broder pour plus d'informations sur la broderie des appliqués.
- ★ In de bedieningshandleiding bij de borduurmachine leest u uitvoeriger hoe u applicaties borduurt.
- ★ Consultare il manuale di istruzioni della macchina da ricamo per i dettagli relativi al ricamo di appliqué.
- ★ Consulte el manual de instrucciones de la máquina de bordar si desea más información sobre cómo bordar apliques.



No.21

57 min	
1	■ (406)
2	■ (420)
3	■ (399)
4	■ (420)
5	■ (399)
↕ 23.4 cm ↔ 19.0 cm	

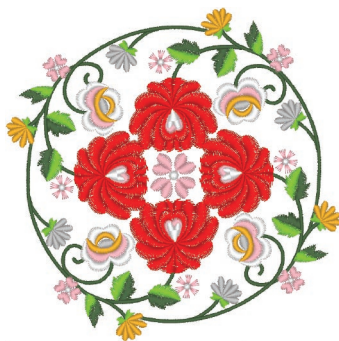

No.22

87 min	
1	■ (079)
2	■ (800)
3	■ (079)
4	■ (001)
5	■ (515)
6	■ (513)
7	■ (079)
8	■ (001)
9	■ (208)
10	■ (005)
11	■ (079)
12	■ (001)
13	■ (208)
14	■ (005)
↕ 19.0 cm ↔ 19.2 cm	



No.23

77 min	
1	■ (502)
2	■ (206)
3	■ (513)
4	■ (534)
5	■ (804)
6	■ (086)
7	■ (208)
8	■ (085)
9	■ (001)
↕ 24.7 cm ↔ 19.3 cm	

Designs using the Print and Stitch function

Motifs utilisant la fonction Imprimer et broder

Disegni che utilizzano la funzione Stampa & Ricama

Designs, die die Funktion Drucken und Sticken verwenden

Ontwerpen met de functie Print en Borduur

Diseños con la función Imprimir y coser



Background image
Hintergrundbild
Image d'arrière-plan
Achtergrondafbeelding
Immagine di sfondo
Imagen de fondo



● No.24

Embroidery pattern
Stickmuster
Motif de broderie
Borduurpatroon
Disegno da ricamo
Patrón de bordado



86 min

1	■ (001)	16	■ (515)
2	■ (339)	17	■ (507)
3	■ (058)	18	■ (808)
4	■ (515)	19	■ (001)
5	■ (507)	20	■ (800)
6	■ (808)	21	■ (107)
7	■ (001)	22	■ (843)
8	■ (800)	23	■ (707)
9	■ (107)	24	■ (800)
10	■ (515)	25	■ (107)
11	■ (507)	26	■ (707)
12	■ (808)	27	■ (208)
13	■ (001)	28	■ (337)
14	■ (800)	29	■ (001)
15	■ (107)	30	■ (707)
↕ 25.6 cm ↔ 19.0 cm			

Refer to the operation manual for the sewing machine for details on how to embroider print and stitch patterns.

Weitere Einzelheiten zum Sticken der Druck- und Stickmuster finden Sie in der Bedienungsanleitung der Nähmaschine.

Reportez-vous au mode d'emploi de la machine à coudre pour de plus amples détails sur la broderie de motifs à imprimer et broder.

In de bedieningshandleiding bij de naaimachine vindt u meer bijzonderheden over het borduren met de functie Print en Borduur.

Fare riferimento al manuale d'istruzione della macchina da cucire per i dettagli su come ricamare i disegni stampa & ricama.

Para obtener más información sobre cómo bordar patrones de impresión y costura, consulte el manual de instrucciones de la máquina de coser.

Patterns marked with ● have been rotated. Check your design placement prior to embroidering.

Muster, die mit ● gekennzeichnet sind, wurden gedreht. Überprüfen Sie die Platzierung Ihres Designs, bevor Sie mit Sticken beginnen.

Les motifs signalés par ● ont été pivotés. Vérifiez l'emplacement de votre motif avant de commencer à broder.

Patronen die zijn gemarkeerd met ● zijn gedraaid. Controleer de plaats van uw ontwerp voordat u gaat borduren.

I disegni contrassegnati dal simbolo ● appaiono ruotati. Prima di procedere al ricamo, verificare la posizione del disegno.

Los patrones marcados con ● se han girado. Compruebe la colocación del diseño antes de bordar.

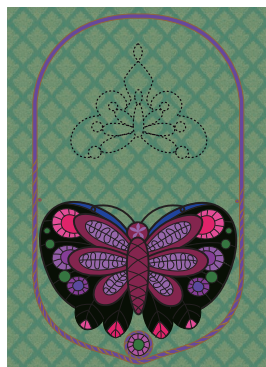
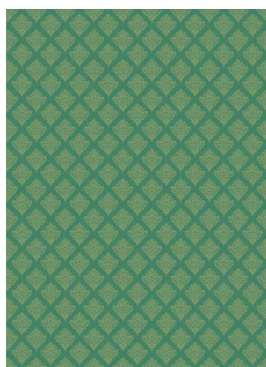
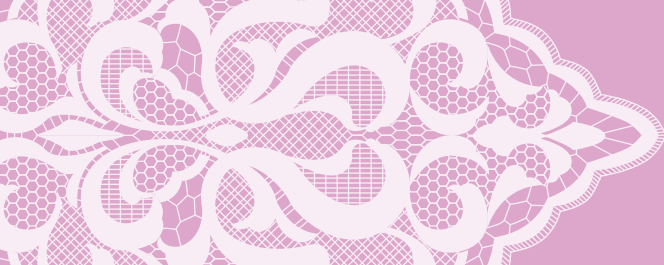

No.25 79 min

1	(612)
2	(620)
3	(614)
4	(807)
5	(086)
6	(107)
7	(534)
8	(405)
9	(900)
10	(612)
11	(620)
12	(614)
13	(807)
14	(086)
15	(107)
16	(534)
17	(405)
18	(900)
19	(107)
20	(612)
21	(900)
22	(534)
23	(086)
24	(614)
25	(900)
26	(614)

↓ 25.7 cm ↔ 15.5 cm

**HINT / TIPP / CONSEIL /
 TIP / SUGGERIMENTO /
 CONSEJO**

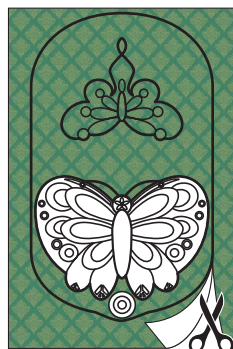

No.26 14 min

1	(001)
---	-------

↓ 16.6 cm ↔ 16.9 cm

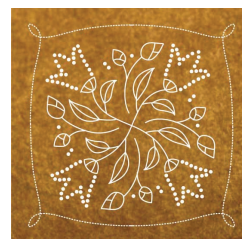

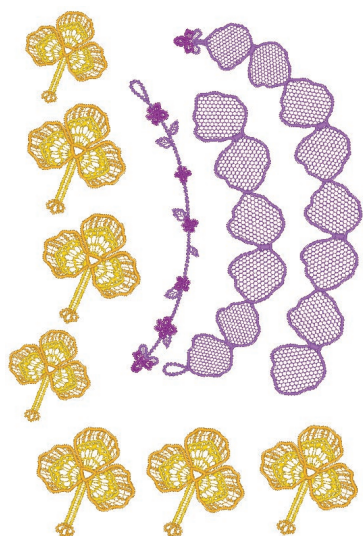
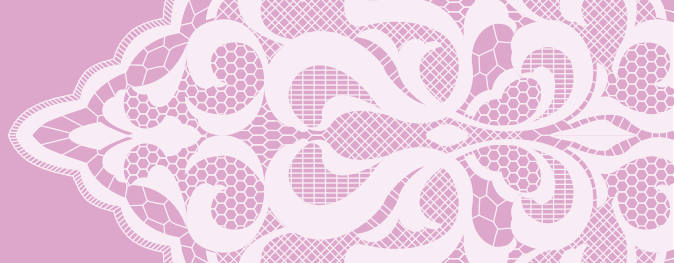

No.27

84 min

1	(612)
2	(620)
3	(612)
4	(620)
5	(208)
6	(206)
7	(208)
8	(206)
9	(208)
10	(206)
11	(208)
12	(206)
13	(208)
14	(206)
15	(208)
16	(206)
17	(208)
18	(206)
19	(208)

↓ 28.4 cm ↔ 19.1 cm

86

No.30

12 min

1	(005)
2	(070)
3	(704)
4	(612)

↓ 16.9 cm ↔ 16.9 cm

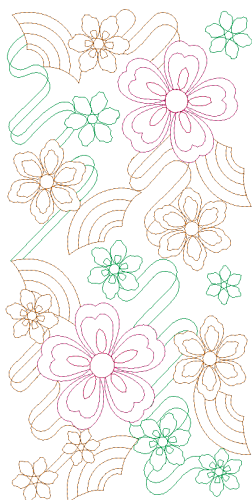
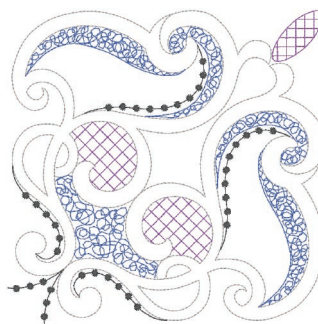

No.28

15 min

1	(348)
2	(085)
3	(086)
4	(513)
5	(085)
6	(086)
7	(348)

↓ 26.8 cm ↔ 13.4 cm



No.29

13 min

1	(019)
2	(509)
3	(209)
4	(019)
5	(509)

↓ 16.8 cm ↔ 16.8 cm

Brother “Exclusives”
 Japanese designs

“Exclusief” Japanse
 ontwerpen van Brother



No.1

82 min			
1	(030)	17	(307)
2	(001)	18	(214)
3	(337)	19	(307)
4	(307)	20	(019)
5	(019)	21	(214)
6	(214)	22	(517)
7	(307)	23	(812)
8	(019)	24	(515)
9	(214)	25	(058)
10	(307)	26	(001)
11	(058)	27	(307)
12	(001)	28	(030)
13	(030)	29	(214)
14	(337)	30	(058)
15	(307)	31	(707)
16	(019)	32	(058)

↓ 24.5 cm ↔ 11.1 cm

Designs using the Print and Stitch function

Motifs utilisant la fonction Imprimer et broder

Disegni che utilizzano la funzione Stampa & Ricama

Brother „Exklusiv“:
 Japanische Designs

Disegni giapponesi
 “Esclusivi” Brother



No.2

65 min			
1	(001)	11	(337)
2	(843)	12	(348)
3	(307)	13	(323)
4	(323)	14	(058)
5	(337)	15	(001)
6	(348)	16	(307)
7	(323)	17	(812)
8	(058)	18	(337)
9	(001)	19	(707)
10	(307)	20	(058)

↓ 24.3 cm ↔ 11.1 cm

Designs, die die Funktion Drucken und Sticken verwenden

Ontwerpen met de functie Print en Borduur

Diseños con la función Imprimir y coser



Background image
 Hintergrundbild
 Image d'arrière-plan
 Achtergrondbefbeelding
 Immagine di sfondo
 Imagen de fondo

No.1



Embroidery pattern
 Stickmuster
 Motif de broderie
 Borduurpatroon
 Disegno da ricamo
 Patrón de bordado



No.2



Refer to the operation manual for the sewing machine for details on how to embroider print and stitch patterns.

Weitere Einzelheiten zum Sticken der Druck- und Stickmuster finden Sie in der Bedienungsanleitung der Nähmaschine.

Reportez-vous au mode d'emploi de la machine à coudre pour de plus amples détails sur la broderie de motifs à imprimer et broder.

In de bedieningshandleiding bij de naaimachine vindt u meer bijzonderheden over het borduren met de functie Print en Borduur.

Fare riferimento al manuale d'istruzione della macchina da cucire per i dettagli su come ricamare i disegni stampa & ricama.

Para obtener más información sobre cómo bordar patrones de impresión y costura, consulte el manual de instrucciones de la máquina de coser.

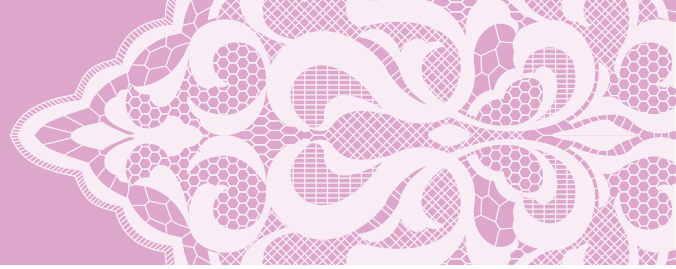

No.3 93 min

1	(017)
2	(900)
3	(086)
4	(214)
5	(323)
6	(900)
7	(214)
8	(086)
9	(124)
10	(614)
11	(517)
12	(519)
13	(515)
14	(513)
15	(509)
16	(010)
17	(804)
18	(206)
19	(030)
20	(017)
21	(804)
22	(086)
23	(206)
24	(614)
25	(206)
26	(208)
27	(010)
28	(079)
29	(086)
30	(124)
31	(513)
32	(206)
33	(030)
34	(800)
35	(126)
36	(206)

Country



No.5 42 min

1	(100)
2	(148)

Country

Zen (Zen)
Zen (Zen)
Zen (Zen)
Zen (Zen)
Zen (Zen)
Zen (Zen)



No.8 10 min

1	(100)
2	(148)

Country

The sky (Ten)
Der Himmel (Ten)
Le ciel (Ten)
Hemel (Ten)
Il cielo (Ten)
Cielo (Ten)



No.6 27 min

1	(100)
2	(148)

Country

Dragon (Ryuu)
Drache (Ryuu)
Dragon (Ryuu)
Draak (Ryuu)
Dragone (Ryuu)
Dragón (Ryuu)



No.9 14 min

1	(100)
2	(148)

Country

Dream (Yume)
Traum (Yume)
Rêve (Yume)
Droom (Yume)
Sogno (Yume)
Sueño (Yume)



No.4 15 min

1	(100)
2	(148)

Country

Love (Ai)
Liebe (Ai)
Amour (Ai)
Liefde (Ai)
Amore (Ai)
Amor (Ai)



No.7 11 min

1	(100)
2	(148)

Country

Good fortune (Kichi)
Glück und Erfolg (Kichi)
Chance (Kichi)
Geluk (Kichi)
Buona fortuna (Kichi)
Buena suerte (Kichi)



No.10 4 min

1	(100)
2	(148)

Country

Friendship (Yuujou)
Freundschaft (Yuujou)
Amitié (Yuujou)
Vriendschap (Yuujou)
Amicizia (Yuujou)
Amistad (Yuujou)

Patterns No.4 – No.10, are designed by Taisen Okamoto.
Muster Nr.4 – Nr.10 wurden von Taisen Okamoto entworfen.

Les motifs 4 à 10 ont été conçus par Taisen Okamoto.

De patronen 4 – 10 zijn ontwikkeld door Taisen Okamoto.

I disegni dal N.4 al N.10 sono stati realizzati da Taisen Okamoto.

Los patrones del n° 4 al n° 10 han sido diseñados por Taisen Okamoto.

◀ Brother “Exclusives” Quilt designs

◀ “Exclusief” quiltdontwerpen van Brother

◀ Brother-,Exklusiv“- Quilt designs

◀ Disegni per trapuntatura “Esclusivi” Brother

◀ Motifs piqués Brother « exclusifs »

◀ Diseños de acolchado “exclusivos” de Brother

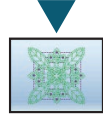

No.1 **14 min**

1	(869)
2	(339)
3	(517)
4	(339)
5	(517)

↓ 29.1 cm ↔ 14.6 cm

No.4 **6 min**

1	(030)
---	-------

↓ 28.2 cm ↔ 14.1 cm

No.8 **24 min**

1	(070)
2	(513)
3	(070)
4	(612)
5	(513)

↓ 20.0 cm ↔ 19.8 cm

No.9 **2 min**

1	(612)
2	(070)

↓ 9.9 cm ↔ 10.0 cm

No.2 **4 min**

1	(869)
2	(517)
3	(339)

↓ 14.5 cm ↔ 7.7 cm

No.5 **1 min**

1	(330)
---	-------

↓ 14.0 cm ↔ 3.5 cm

No.10 **5 min**

1	(005)
2	(612)

↓ 26.9 cm ↔ 7.8 cm

No.3 **5 min**

1	(030)
---	-------

↓ 28.4 cm ↔ 14.3 cm

No.6 **28 min**

1	(817)
2	(620)
3	(817)
4	(620)
5	(607)
6	(817)
7	(620)
8	(607)
9	(817)
10	(620)
11	(607)
12	(620)

↓ 19.9 cm ↔ 19.9 cm

No.7 **2 min**

1	(817)
2	(620)

↓ 3.2 cm ↔ 9.1 cm

No.11 **5 min**

1	(209)
2	(509)

↓ 27.9 cm ↔ 7.6 cm

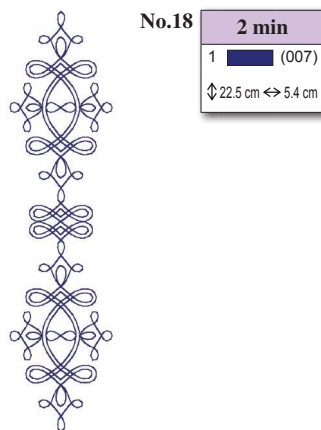
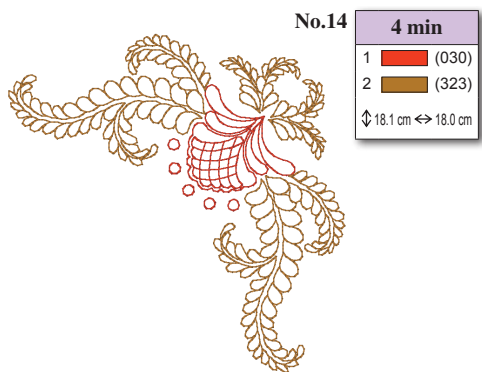
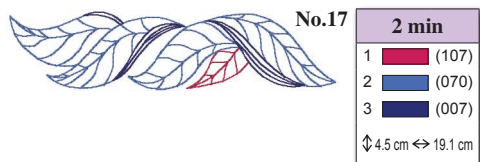
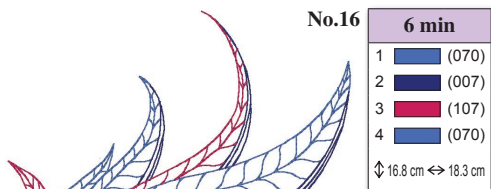
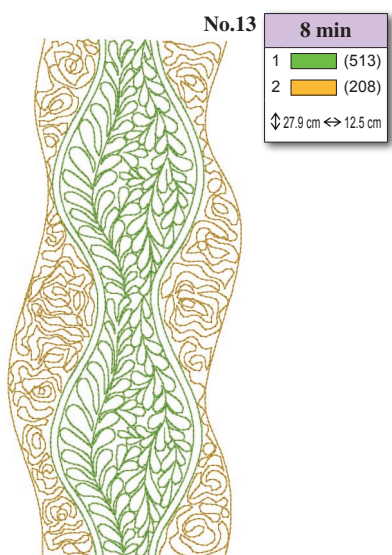
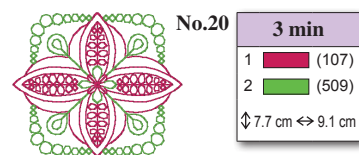
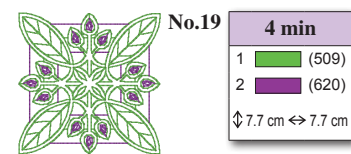
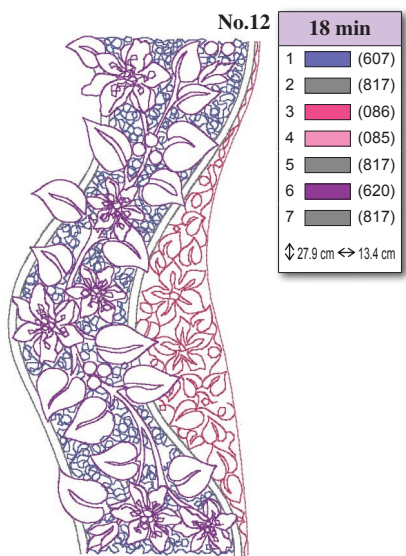
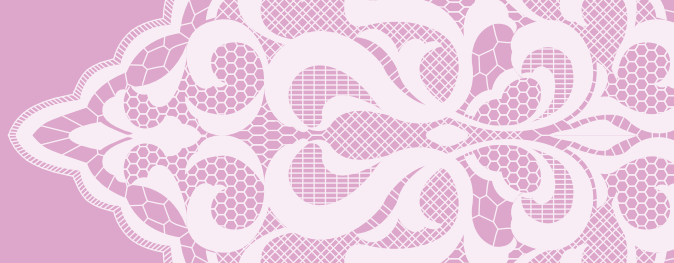

◁ Striped character patterns

◁ Gestreifte Buchstabenmuster

◁ Motifs de caractères rayés

◁ Gestreepte letterpatronen

◁ Disegni carattere a righe

◁ Patrones de caracteres con franjas

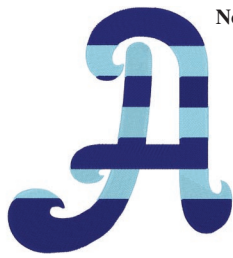

No.1 **35 min**
 1 (017)
 2 (007)
 ⇅ 16.2 cm ⇔ 14.8 cm



No.6 **33 min**
 1 (017)
 2 (007)
 ⇅ 16.5 cm ⇔ 12.2 cm

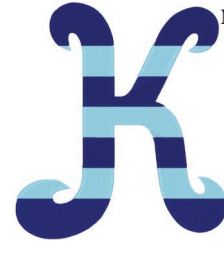

No.11 **34 min**
 1 (017)
 2 (007)
 ⇅ 15.6 cm ⇔ 13.9 cm



No.2 **38 min**
 1 (017)
 2 (007)
 ⇅ 15.3 cm ⇔ 14.1 cm



No.7 **35 min**
 1 (017)
 2 (007)
 ⇅ 15.1 cm ⇔ 12.1 cm



No.12 **28 min**
 1 (017)
 2 (007)
 ⇅ 15.4 cm ⇔ 12.0 cm



No.3 **31 min**
 1 (017)
 2 (007)
 ⇅ 15.1 cm ⇔ 10.0 cm



No.8 **34 min**
 1 (017)
 2 (007)
 ⇅ 15.6 cm ⇔ 14.1 cm

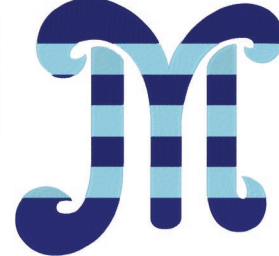

No.13 **53 min**
 1 (017)
 2 (007)
 ⇅ 16.9 cm ⇔ 17.6 cm



No.4 **37 min**
 1 (017)
 2 (007)
 ⇅ 16.6 cm ⇔ 12.8 cm



No.9 **26 min**
 1 (017)
 2 (007)
 ⇅ 15.4 cm ⇔ 11.3 cm



No.14 **46 min**
 1 (017)
 2 (007)
 ⇅ 16.3 cm ⇔ 15.1 cm



No.5 **32 min**
 1 (017)
 2 (007)
 ⇅ 15.1 cm ⇔ 11.3 cm



No.10 **28 min**
 1 (017)
 2 (007)
 ⇅ 17.3 cm ⇔ 12.1 cm



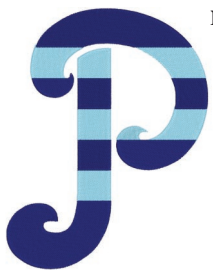
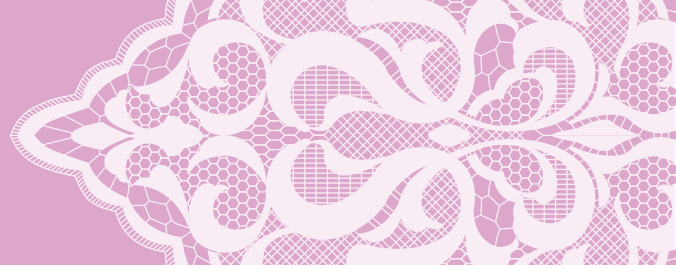

No.15 **31 min**
 1 (017)
 2 (007)
 ⇅ 15.1 cm ⇔ 10.2 cm



No.16

36 min



1  (017)
2  (007)

↓ 17.2 cm ↔ 13.2 cm



No.22

30 min



1  (017)
2  (007)

↓ 15.9 cm ↔ 11.5 cm



No.28

26 min



1  (017)
2  (007)

↓ 14.7 cm ↔ 10.2 cm



No.17

36 min



1  (017)
2  (007)

↓ 16.6 cm ↔ 11.8 cm



No.23

46 min

1  (017)
2  (007)

↓ 15.3 cm ↔ 16.4 cm



No.29

17 min

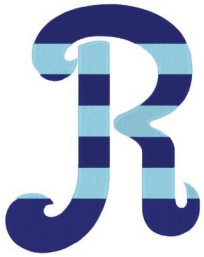

1  (017)
2  (007)

↓ 10.8 cm ↔ 7.4 cm



No.18

37 min



1  (017)
2  (007)

↓ 16.4 cm ↔ 12.8 cm



No.24

32 min



1  (017)
2  (007)

↓ 15.0 cm ↔ 13.8 cm



No.30

27 min



1  (017)
2  (007)

↓ 14.9 cm ↔ 10.1 cm



No.19

37 min



1  (017)
2  (007)

↓ 15.7 cm ↔ 11.3 cm



No.25

33 min



1  (017)
2  (007)

↓ 16.2 cm ↔ 11.6 cm



No.31

19 min

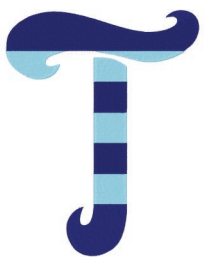

1  (017)
2  (007)

↓ 10.7 cm ↔ 7.4 cm



No.20

24 min



1  (017)
2  (007)

↓ 16.2 cm ↔ 12.7 cm



No.26

30 min

1  (017)
2  (007)

↓ 15.3 cm ↔ 12.0 cm



No.32

23 min



1  (017)
2  (007)

↓ 17.6 cm ↔ 8.9 cm



No.21

33 min



1  (017)
2  (007)

↓ 15.1 cm ↔ 12.3 cm



No.27

19 min



1  (017)
2  (007)

↓ 10.5 cm ↔ 8.8 cm



No.33

26 min

1  (017)
2  (007)

↓ 13.9 cm ↔ 9.4 cm

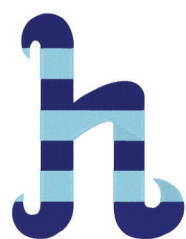

No.34 27 min
 1 (017)
 2 (007)
 ⇅ 14.9 cm ↔ 11.3 cm

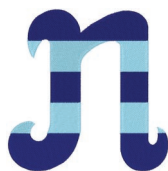

No.40 22 min
 1 (017)
 2 (007)
 ⇅ 10.6 cm ↔ 10.5 cm



No.46 19 min
 1 (017)
 2 (007)
 ⇅ 14.1 cm ↔ 8.4 cm



No.35 16 min
 1 (017)
 2 (007)
 ⇅ 14.1 cm ↔ 6.4 cm



No.41 19 min
 1 (017)
 2 (007)
 ⇅ 10.8 cm ↔ 7.1 cm



No.47 22 min
 1 (017)
 2 (007)
 ⇅ 10.8 cm ↔ 10.6 cm



No.36 19 min
 1 (017)
 2 (007)
 ⇅ 17.5 cm ↔ 6.2 cm



No.42 25 min
 1 (017)
 2 (007)
 ⇅ 14.0 cm ↔ 10.4 cm



No.48 19 min
 1 (017)
 2 (007)
 ⇅ 10.7 cm ↔ 9.8 cm



No.37 28 min
 1 (017)
 2 (007)
 ⇅ 15.1 cm ↔ 11.7 cm



No.43 24 min
 1 (017)
 2 (007)
 ⇅ 13.8 cm ↔ 9.5 cm



No.49 28 min
 1 (017)
 2 (007)
 ⇅ 10.5 cm ↔ 13.2 cm



No.38 18 min
 1 (017)
 2 (007)
 ⇅ 15.3 cm ↔ 6.9 cm



No.44 15 min
 1 (017)
 2 (007)
 ⇅ 10.6 cm ↔ 7.8 cm



No.50 20 min
 1 (017)
 2 (007)
 ⇅ 10.3 cm ↔ 10.3 cm



No.39 32 min
 1 (017)
 2 (007)
 ⇅ 10.9 cm ↔ 15.0 cm



No.45 20 min
 1 (017)
 2 (007)
 ⇅ 10.7 cm ↔ 8.8 cm



No.51 26 min
 1 (017)
 2 (007)
 ⇅ 13.6 cm ↔ 8.6 cm

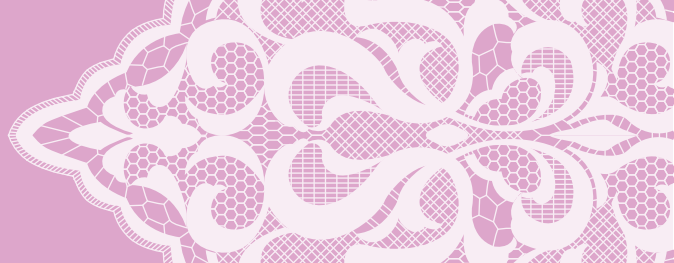

No.52 **17 min**
 1 (017)
 2 (007)
 ↓ 10.5 cm ↔ 9.0 cm



No.58 **36 min**
 1 (017)
 2 (007)
 ↓ 15.8 cm ↔ 10.1 cm



No.64 **45 min**
 1 (017)
 2 (007)
 ↓ 15.4 cm ↔ 13.7 cm



No.53 **28 min**
 1 (017)
 2 (007)
 ↓ 15.1 cm ↔ 9.7 cm



No.59 **34 min**
 1 (017)
 2 (007)
 ↓ 15.1 cm ↔ 9.4 cm



No.65 **37 min**
 1 (017)
 2 (007)
 ↓ 16.4 cm ↔ 10.0 cm



No.54 **18 min**
 1 (017)
 2 (007)
 ↓ 15.6 cm ↔ 5.9 cm



No.60 **24 min**
 1 (017)
 2 (007)
 ↓ 15.1 cm ↔ 10.3 cm



No.66 **33 min**
 1 (017)
 2 (007)
 ↓ 15.3 cm ↔ 12.6 cm



No.55 **28 min**
 1 (017)
 2 (007)
 ↓ 14.9 cm ↔ 10.3 cm



No.61 **31 min**
 1 (017)
 2 (007)
 ↓ 15.3 cm ↔ 9.7 cm



No.67 **39 min**
 1 (017)
 2 (007)
 ↓ 15.1 cm ↔ 12.9 cm



No.56 **31 min**
 1 (017)
 2 (007)
 ↓ 15.2 cm ↔ 10.3 cm



No.62 **30 min**
 1 (017)
 2 (007)
 ↓ 15.2 cm ↔ 9.3 cm



No.68 **30 min**
 1 (017)
 2 (007)
 ↓ 15.8 cm ↔ 10.1 cm



No.57 **30 min**
 1 (017)
 2 (007)
 ↓ 15.3 cm ↔ 11.2 cm

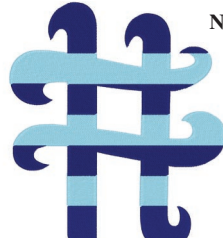

No.63 **42 min**
 1 (017)
 2 (007)
 ↓ 16.3 cm ↔ 14.2 cm



No.69 **5 min**
 1 (017)
 2 (007)
 ↓ 2.5 cm ↔ 5.2 cm

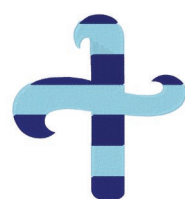

No.70 **20 min**
 1 (017)
 2 (007)
 ⇅ 12.2 cm ↔ 11.4 cm



No.71 **21 min**
 1 (017)
 2 (007)
 ⇅ 10.3 cm ↔ 9.9 cm

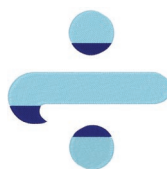

No.72 **14 min**
 1 (017)
 2 (007)
 ⇅ 10.4 cm ↔ 10.7 cm



No.73 **17 min**
 1 (017)
 2 (007)
 ⇅ 8.5 cm ↔ 10.2 cm



No.74 **16 min**
 1 (017)
 2 (007)
 ⇅ 8.6 cm ↔ 8.4 cm



No.75 **4 min**
 1 (017)
 2 (007)
 ⇅ 3.4 cm ↔ 3.4 cm



No.76 **5 min**
 1 (017)
 2 (007)
 ⇅ 5.2 cm ↔ 3.5 cm



No.77 **37 min**
 1 (017)
 2 (007)
 ⇅ 14.9 cm ↔ 13.5 cm



No.78 **23 min**
 1 (017)
 2 (007)
 ⇅ 15.6 cm ↔ 9.0 cm



No.79 **17 min**
 1 (017)
 2 (007)
 ⇅ 16.3 cm ↔ 4.9 cm



No.80 **49 min**
 1 (017)
 2 (007)
 ⇅ 15.5 cm ↔ 14.0 cm



No.81 **19 min**
 1 (017)
 2 (007)
 ⇅ 10.8 cm ↔ 10.7 cm



No.82 **19 min**
 1 (017)
 2 (007)
 ⇅ 11.2 cm ↔ 10.3 cm



No.83 **17 min**
 1 (017)
 2 (007)
 ⇅ 18.7 cm ↔ 6.4 cm



No.84 **16 min**
 1 (017)
 2 (007)
 ⇅ 18.6 cm ↔ 6.1 cm



No.85 **17 min**
 1 (017)
 2 (007)
 ⇅ 18.8 cm ↔ 5.5 cm



No.86 **17 min**
 1 (017)
 2 (007)
 ⇅ 19.0 cm ↔ 5.3 cm



No.87 **19 min**
 1 (017)
 2 (007)
 ⇅ 16.4 cm ↔ 11.4 cm



No.88 **20 min**
 1 (017)
 2 (007)
 ⇅ 16.8 cm ↔ 11.9 cm

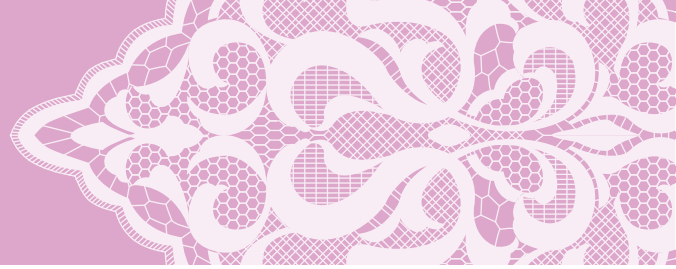

No.89 **12 min**

1		(017)
2		(007)

↓ 4.8 cm ↔ 13.0 cm

No.93 **34 min**

1		(017)
2		(007)

↓ 15.1 cm ↔ 15.0 cm

No.97 **9 min**

1		(017)
2		(007)

↓ 5.2 cm ↔ 6.1 cm

No.90 **7 min**

1		(017)
2		(007)

↓ 10.4 cm ↔ 3.4 cm

No.94 **34 min**

1		(017)
2		(007)

↓ 10.2 cm ↔ 17.8 cm

No.98 **4 min**

1		(017)
2		(007)

↓ 5.2 cm ↔ 2.8 cm

No.91 **9 min**

1		(017)
2		(007)

↓ 12.1 cm ↔ 3.5 cm

No.95 **11 min**

1		(017)
2		(007)

↓ 5.2 cm ↔ 7.8 cm

No.99 **5 min**

1		(017)
2		(007)

↓ 5.2 cm ↔ 3.5 cm

No.92 **32 min**

1		(017)
2		(007)

↓ 15.1 cm ↔ 15.0 cm

No.96 **11 min**

1		(017)
2		(007)

↓ 5.2 cm ↔ 7.8 cm

No.100 **5 min**

1		(017)
2		(007)

↓ 5.2 cm ↔ 3.5 cm

↳ **Block character patterns**

↳ **Blockbuchstabenmuster**

↳ **Motifs de caractères de type empreinte**

↳ **Blokletterpatronen**

↳ **Disegni carattere a blocchi**

↳ **Patrones de caracteres en bloques**



No.1 **44 min**

1		(509)
2		(001)
3		(900)

↓ 15.2 cm ↔ 11.2 cm

No.3 **42 min**

1		(509)
2		(001)
3		(900)

↓ 15.2 cm ↔ 10.3 cm

No.5 **40 min**

1		(509)
2		(001)
3		(900)

↓ 15.2 cm ↔ 9.1 cm

No.2 **51 min**

1		(509)
2		(001)
3		(900)

↓ 15.2 cm ↔ 10.3 cm

No.4 **48 min**

1		(509)
2		(001)
3		(900)

↓ 15.2 cm ↔ 10.3 cm

No.6 **34 min**

1		(509)
2		(001)
3		(900)

↓ 15.2 cm ↔ 9.1 cm



No.7 49 min

1		(509)
2		(001)
3		(900)

↕ 15.2 cm ↔ 10.3 cm



No.13 64 min

1		(509)
2		(001)
3		(900)

↕ 15.2 cm ↔ 12.5 cm



No.19 46 min

1		(509)
2		(001)
3		(900)

↕ 15.2 cm ↔ 10.4 cm



No.8 47 min

1		(509)
2		(001)
3		(900)

↕ 15.2 cm ↔ 10.3 cm



No.14 53 min

1		(509)
2		(001)
3		(900)

↕ 15.2 cm ↔ 10.3 cm



No.20 29 min

1		(509)
2		(001)
3		(900)

↕ 15.2 cm ↔ 10.4 cm



No.9 23 min

1		(509)
2		(001)
3		(900)

↕ 15.2 cm ↔ 3.9 cm

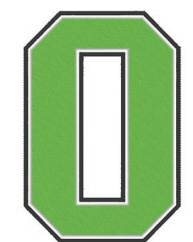

No.15 47 min

1		(509)
2		(001)
3		(900)

↕ 15.2 cm ↔ 10.3 cm



No.21 45 min

1		(509)
2		(001)
3		(900)

↕ 15.2 cm ↔ 10.3 cm



No.10 33 min

1		(509)
2		(001)
3		(900)

↕ 15.2 cm ↔ 10.4 cm



No.16 41 min

1		(509)
2		(001)
3		(900)

↕ 15.2 cm ↔ 10.3 cm



No.22 42 min

1		(509)
2		(001)
3		(900)

↕ 15.2 cm ↔ 11.2 cm



No.11 47 min

1		(509)
2		(001)
3		(900)

↕ 15.2 cm ↔ 10.7 cm



No.17 49 min

1		(509)
2		(001)
3		(900)

↕ 15.2 cm ↔ 10.9 cm



No.23 66 min

1		(509)
2		(001)
3		(900)

↕ 15.2 cm ↔ 14.1 cm

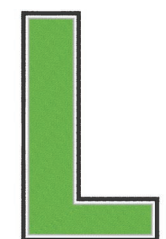

No.12 28 min

1		(509)
2		(001)
3		(900)

↕ 15.2 cm ↔ 9.1 cm

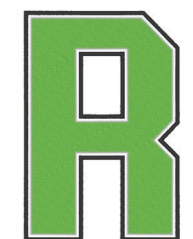

No.18 50 min

1		(509)
2		(001)
3		(900)

↕ 15.2 cm ↔ 10.3 cm



No.24 40 min

1		(509)
2		(001)
3		(900)

↕ 15.2 cm ↔ 10.4 cm

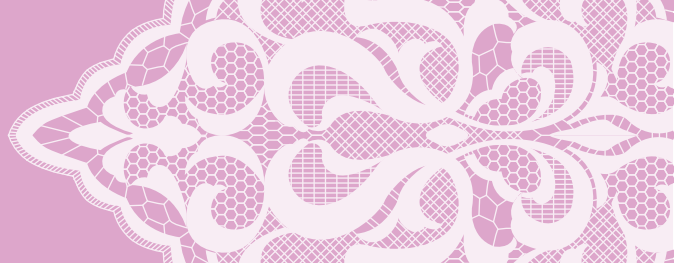

No.25 **34 min**

1		(509)
2		(001)
3		(900)

↓ 15.2 cm ↔ 11.3 cm



No.31 **32 min**

1		(509)
2		(001)
3		(900)

↓ 10.7 cm ↔ 8.6 cm



No.37 **36 min**

1		(509)
2		(001)
3		(900)

↓ 15.2 cm ↔ 8.9 cm



No.26 **38 min**

1		(509)
2		(001)
3		(900)

↓ 15.2 cm ↔ 9.7 cm



No.32 **24 min**

1		(509)
2		(001)
3		(900)

↓ 15.2 cm ↔ 8.3 cm



No.38 **21 min**

1		(509)
2		(001)
3		(900)

↓ 15.2 cm ↔ 3.4 cm



No.27 **32 min**

1		(509)
2		(001)
3		(900)

↓ 10.7 cm ↔ 8.6 cm



No.33 **42 min**

1		(509)
2		(001)
3		(900)

↓ 14.9 cm ↔ 8.6 cm



No.39 **44 min**

1		(509)
2		(001)
3		(900)

↓ 10.7 cm ↔ 12.5 cm



No.28 **37 min**

1		(509)
2		(001)
3		(900)

↓ 15.2 cm ↔ 8.6 cm



No.34 **35 min**

1		(509)
2		(001)
3		(900)

↓ 15.2 cm ↔ 8.6 cm



No.40 **30 min**

1		(509)
2		(001)
3		(900)

↓ 10.7 cm ↔ 8.6 cm



No.29 **28 min**

1		(509)
2		(001)
3		(900)

↓ 10.7 cm ↔ 8.6 cm



No.35 **20 min**

1		(509)
2		(001)
3		(900)

↓ 15.2 cm ↔ 3.4 cm



No.41 **30 min**

1		(509)
2		(001)
3		(900)

↓ 10.7 cm ↔ 8.6 cm



No.30 **37 min**

1		(509)
2		(001)
3		(900)

↓ 15.2 cm ↔ 8.6 cm



No.36 **26 min**

1		(509)
2		(001)
3		(900)

↓ 19.4 cm ↔ 4.9 cm



No.42 **37 min**

1		(509)
2		(001)
3		(900)

↓ 14.9 cm ↔ 8.6 cm

Embroidery Pattern Color Change Table
 Stickmuster-Farbtabelle
 Tableau de changement de couleur des motifs de broderie
 Kleurwijzigingstabel voor de borduurpatronen
 Tabella di cambiamento colori degli schemi di ricamo
 Tabla de cambio de color para patrones de bordado



No.43 **36 min**

1	■ (509)
2	□ (001)
3	■ (900)

↕ 14.9 cm ↔ 8.6 cm



No.49 **46 min**

1	■ (509)
2	□ (001)
3	■ (900)

↕ 10.7 cm ↔ 14.3 cm



No.55 **42 min**

1	■ (509)
2	□ (001)
3	■ (900)

↕ 15.2 cm ↔ 9.9 cm



No.44 **17 min**

1	■ (509)
2	□ (001)
3	■ (900)

↕ 10.7 cm ↔ 5.9 cm



No.50 **27 min**

1	■ (509)
2	□ (001)
3	■ (900)

↕ 10.7 cm ↔ 8.9 cm



No.56 **43 min**

1	■ (509)
2	□ (001)
3	■ (900)

↕ 15.2 cm ↔ 9.9 cm



No.45 **31 min**

1	■ (509)
2	□ (001)
3	■ (900)

↕ 10.7 cm ↔ 8.4 cm



No.51 **31 min**

1	■ (509)
2	□ (001)
3	■ (900)

↕ 14.9 cm ↔ 9.4 cm



No.57 **40 min**

1	■ (509)
2	□ (001)
3	■ (900)

↕ 15.2 cm ↔ 10.6 cm



No.46 **24 min**

1	■ (509)
2	□ (001)
3	■ (900)

↕ 14.0 cm ↔ 6.8 cm



No.52 **25 min**

1	■ (509)
2	□ (001)
3	■ (900)

↕ 10.7 cm ↔ 7.5 cm



No.58 **42 min**

1	■ (509)
2	□ (001)
3	■ (900)

↕ 15.2 cm ↔ 9.9 cm



No.47 **30 min**

1	■ (509)
2	□ (001)
3	■ (900)

↕ 10.7 cm ↔ 8.6 cm



No.53 **46 min**

1	■ (509)
2	□ (001)
3	■ (900)

↕ 15.2 cm ↔ 9.9 cm



No.59 **47 min**

1	■ (509)
2	□ (001)
3	■ (900)

↕ 15.2 cm ↔ 9.9 cm



No.48 **27 min**

1	■ (509)
2	□ (001)
3	■ (900)

↕ 10.7 cm ↔ 9.4 cm



No.54 **24 min**

1	■ (509)
2	□ (001)
3	■ (900)

↕ 15.2 cm ↔ 5.7 cm





No.60 **30 min**

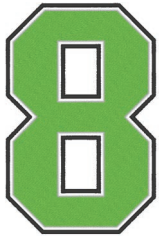

1	■ (509)
2	□ (001)
3	■ (900)

↕ 15.2 cm ↔ 9.9 cm





No.61 **48 min**
 1  (509)
 2  (001)
 3  (900)
 ↓ 15.2 cm ↔ 9.9 cm





No.67 **45 min**
 1  (509)
 2  (001)
 3  (900)
 ↓ 15.2 cm ↔ 10.6 cm





No.75 **6 min**
 1  (509)
 2  (001)
 3  (900)
 ↓ 3.4 cm ↔ 3.9 cm





No.62 **47 min**
 1  (509)
 2  (001)
 3  (900)
 ↓ 15.2 cm ↔ 9.9 cm





No.68 **41 min**
 1  (509)
 2  (001)
 3  (900)
 ↓ 15.2 cm ↔ 10.6 cm



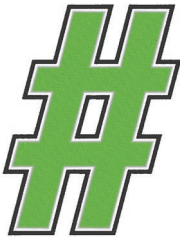

No.76 **8 min**
 1  (509)
 2  (001)
 3  (900)
 ↓ 5.4 cm ↔ 4.7 cm





No.63 **46 min**
 1  (509)
 2  (001)
 3  (900)
 ↓ 15.2 cm ↔ 11.8 cm





No.69 **7 min**
 1  (509)
 2  (001)
 3  (900)
 ↓ 2.6 cm ↔ 5.5 cm



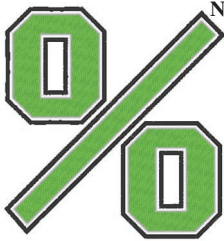

No.77 **53 min**
 1  (509)
 2  (001)
 3  (900)
 ↓ 15.2 cm ↔ 13.7 cm





No.64 **57 min**
 1  (509)
 2  (001)
 3  (900)
 ↓ 15.2 cm ↔ 14.5 cm





No.70 **17 min**
 1  (509)
 2  (001)
 3  (900)
 ↓ 9.3 cm ↔ 9.3 cm





No.78 **35 min**
 1  (509)
 2  (001)
 3  (900)
 ↓ 15.2 cm ↔ 10.3 cm





No.71 **20 min**
 1  (509)
 2  (001)
 3  (900)
 ↓ 8.8 cm ↔ 8.8 cm





No.79 **24 min**
 1  (509)
 2  (001)
 3  (900)
 ↓ 15.2 cm ↔ 4.1 cm



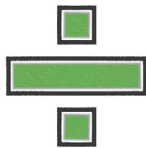

No.65 **48 min**
 1  (509)
 2  (001)
 3  (900)
 ↓ 18.3 cm ↔ 9.9 cm





No.72 **18 min**
 1  (509)
 2  (001)
 3  (900)
 ↓ 9.3 cm ↔ 9.3 cm





No.73 **21 min**
 1  (509)
 2  (001)
 3  (900)
 ↓ 6.1 cm ↔ 9.3 cm





No.80 **67 min**
 1  (509)
 2  (001)
 3  (900)
 ↓ 15.2 cm ↔ 13.8 cm





No.66 **41 min**
 1  (509)
 2  (001)
 3  (900)
 ↓ 15.2 cm ↔ 10.1 cm



No.74 **22 min**
 1  (509)
 2  (001)
 3  (900)
 ↓ 8.2 cm ↔ 8.3 cm

Embroidery Pattern Color Change Table
 Stickmuster-Farbtabelle
 Tableau de changement de couleur des motifs de broderie
 Kleurwijzigingstabel voor de borduurpatronen
 Tabella di cambiamento colori degli schemi di ricamo
 Tabla de cambio de color para patrones de bordado



No.81 **17 min**

1		(509)
2		(001)
3		(900)

↕ 10.8 cm ↔ 7.1 cm





No.87 **21 min**

1		(509)
2		(001)
3		(900)

↕ 15.7 cm ↔ 9.7 cm





No.93 **69 min**

1		(509)
2		(001)
3		(900)

↕ 15.2 cm ↔ 15.2 cm





No.82 **17 min**

1		(509)
2		(001)
3		(900)

↕ 10.8 cm ↔ 7.1 cm





No.88 **21 min**

1		(509)
2		(001)
3		(900)

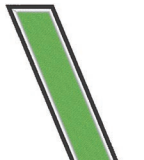
↕ 15.7 cm ↔ 9.7 cm





No.94 **46 min**

1		(509)
2		(001)
3		(900)

↕ 9.3 cm ↔ 14.7 cm





No.83 **27 min**

1		(509)
2		(001)
3		(900)

↕ 19.9 cm ↔ 5.5 cm





No.89 **14 min**

1		(509)
2		(001)
3		(900)

↕ 5.2 cm ↔ 10.7 cm





No.95 **17 min**

1		(509)
2		(001)
3		(900)

↕ 5.4 cm ↔ 9.0 cm





No.84 **27 min**

1		(509)
2		(001)
3		(900)

↕ 19.9 cm ↔ 5.5 cm





No.90 **13 min**

1		(509)
2		(001)
3		(900)

↕ 10.7 cm ↔ 3.9 cm





No.96 **16 min**

1		(509)
2		(001)
3		(900)

↕ 5.4 cm ↔ 9.0 cm





No.85 **30 min**

1		(509)
2		(001)
3		(900)

↕ 19.9 cm ↔ 5.4 cm





No.91 **15 min**

1		(509)
2		(001)
3		(900)

↕ 12.6 cm ↔ 4.7 cm





No.97 **14 min**

1		(509)
2		(001)
3		(900)

↕ 5.0 cm ↔ 8.0 cm





No.86 **30 min**

1		(509)
2		(001)
3		(900)

↕ 19.9 cm ↔ 5.4 cm





No.92 **67 min**

1		(509)
2		(001)
3		(900)

↕ 15.2 cm ↔ 15.2 cm





No.98 **7 min**

1		(509)
2		(001)
3		(900)

↕ 5.0 cm ↔ 3.5 cm





No.99 **8 min**

1		(509)
2		(001)
3		(900)

↕ 5.4 cm ↔ 4.7 cm



No.100 **7 min**

1		(509)
2		(001)
3		(900)

↕ 5.0 cm ↔ 3.5 cm



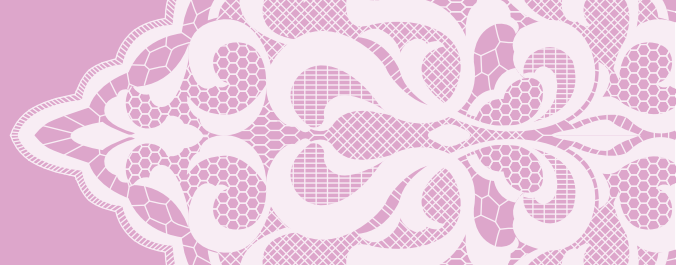

Large buttonhole patterns

Muster für große Knopflöcher

Grands motifs de boutonnières

Grote knoopsgatpatronen

Disegni per asole grandi

Patrones para ojales de gran tamaño



It is recommended to combine these buttonholes with the "Design patterns (for buttonhole decoration)" shown on the next page. Refer to pages 82 to 85 for examples of combinations.

Es wird empfohlen, diese Muster mit den „Designmustern (zum Dekorieren von Knopflöchern)“ auf der nächsten Seite zu kombinieren. Auf den Seiten 82 bis 85 finden Sie Kombinationsbeispiele.

Il est recommandé de combiner ces motifs aux « motifs de dessins (pour la décoration des boutonnières) » à la page suivante. Reportez-vous aux pages 82 à 85 pour des exemples de combinaisons.

Het is aan te raden om deze patronen te combineren met de "Ontwerppatronen (om knoopsgaten te versieren)" op de volgende pagina. Voorbeelden van combinaties vindt u op pag. 82 – 85.

Si consiglia di combinare questi disegni con "Creazione di disegni (per la decorazione di asole)" della pagina successiva. Per gli esempi di combinazioni, fare riferimento alle pagine da 82 a 85.

Es recomendable combinar estos patrones con los "Patrones de diseño (para la decoración de ojales)" mostrados en la página siguiente. Encontrará ejemplos de combinaciones en las páginas 82 a 85.

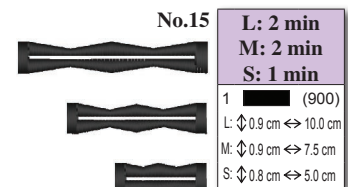
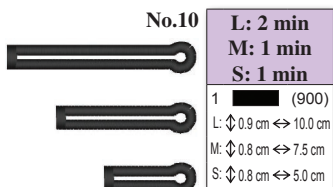
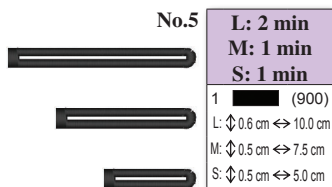
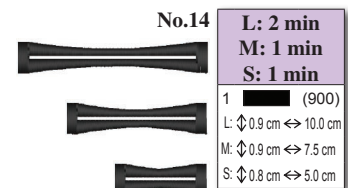
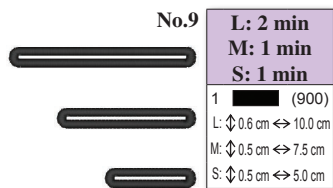
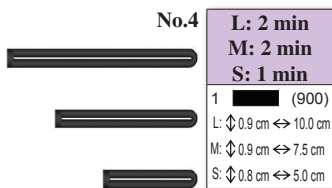
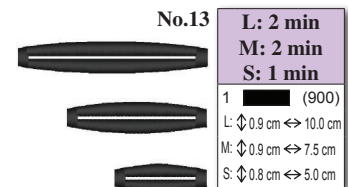
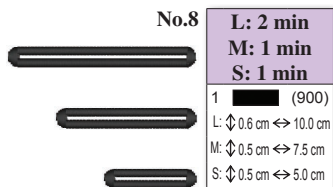
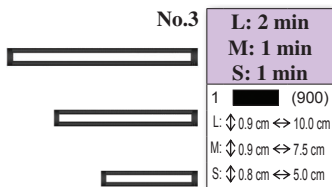
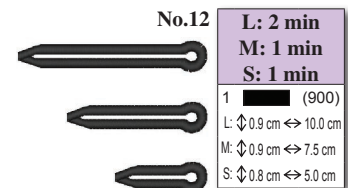
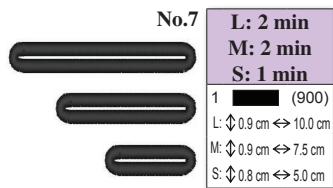
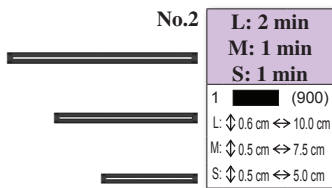
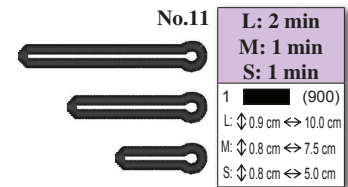
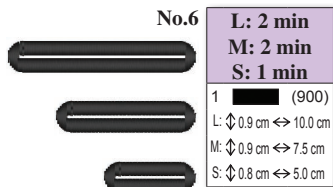
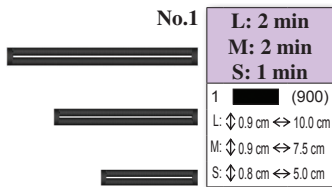

*1

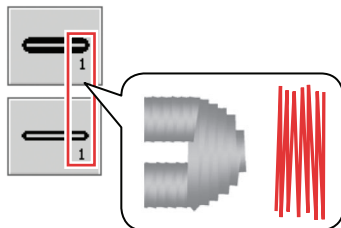

*2

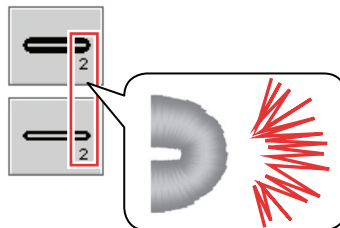

Design patterns (for buttonhole decoration)

Ontwerppatronen (om knoopsgaten te versieren)

Designmuster (zum Dekorieren von Knopflöchern)

Creazione di disegni (per la decorazione di asole)

Motifs de dessins (pour la décoration des boutons)

Patrones de diseño (para la decoración de ojales)

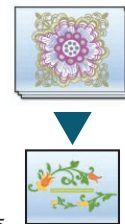

It is recommended to use these designs to decorate the "Large buttonhole patterns" shown on the previous page. Refer to pages 82 to 85 for examples of combinations.

Es wird empfohlen, diese Muster zum Dekorieren der „Muster für große Knopflöcher“ auf der vorherigen Seite zu verwenden. Auf den Seiten 82 bis 85 finden Sie Kombinationsbeispiele.

Il est recommandé d'utiliser ces motifs pour décorer les « grands motifs de boutons » de la page précédente. Reportez-vous aux pages 82 à 85 pour des exemples de combinaisons.

Het is aan te raden om deze patronen te gebruiken om de "Grote knoopsgatpatronen" op de vorige pagina te versieren. Voorbeelden van combinaties vindt u op pag. 82 – 85.

Si consiglia di utilizzare questi disegni per decorare i "Disegni per asole grandi" della pagina precedente. Per gli esempi di combinazioni, fare riferimento alle pagine da 82 a 85.

Es recomendable utilizar estos patrones para decorar los "Patrones para ojales de gran tamaño" mostrados en la página anterior. Encontrará ejemplos de combinaciones en las páginas 82 a 85.

No.1 **3 min**

1		(513)
2		(206)
3		(010)
4		(209)

↕ 3.0 cm ↔ 6.4 cm

No.6 **1 min**

1		(399)
---	--	-------

↕ 1.6 cm ↔ 2.6 cm

No.11 **3 min**

1		(808)
2		(800)
3		(208)
4		(001)

↕ 3.5 cm ↔ 8.4 cm

No.2 **1 min**

1		(513)
2		(010)
3		(206)

↕ 1.8 cm ↔ 3.3 cm

No.7 **1 min**

1		(017)
2		(005)
3		(812)

↕ 1.6 cm ↔ 4.3 cm

No.12 **4 min**

1		(085)
2		(070)
3		(209)

↕ 3.3 cm ↔ 5.8 cm

No.3 **4 min**

1		(513)
2		(209)
3		(010)
4		(206)
5		(209)

↕ 4.7 cm ↔ 7.2 cm

No.8 **1 min**

1		(399)
2		(019)
3		(206)

↕ 3.5 cm ↔ 4.1 cm

No.13 **10 min**

1		(019)
2		(017)
3		(513)
4		(019)

↕ 12.6 cm ↔ 6.2 cm

No.4 **2 min**

1		(502)
2		(810)
3		(612)

↕ 3.6 cm ↔ 10.9 cm

No.9 **2 min**

1		(804)
2		(005)

↕ 3.0 cm ↔ 7.0 cm

No.14 **1 min**

1		(107)
2		(007)

↕ 0.4 cm ↔ 5.3 cm

No.5 **1 min**

1		(399)
---	--	-------

↕ 1.4 cm ↔ 4.4 cm

No.10 **1 min**

1		(804)
2		(005)

↕ 1.8 cm ↔ 5.6 cm

No.15 **1 min**

1		(007)
2		(107)
3		(007)

↕ 4.7 cm ↔ 4.3 cm

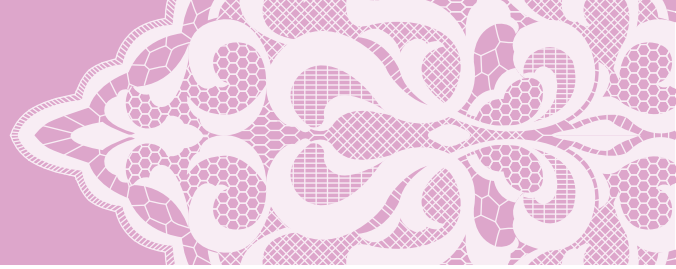

◁ Greek alphabet patterns

◁ Buchstabenmuster des griechischen Alphabets

◁ Motifs alphabet grec



◁ Griechse alfabetpatronen

◁ Disegni alfabeto greco

◁ Costuras de caracteres alfabéticos griegos



No.1 **5 min**

1		(209)
2		(513)
3		(405)

↕ 5.6 cm ↔ 5.7 cm



No.6 **5 min**

1		(209)
2		(513)
3		(405)

↕ 5.4 cm ↔ 4.8 cm



No.11 **4 min**

1		(209)
2		(513)
3		(405)

↕ 5.6 cm ↔ 5.4 cm



No.2 **7 min**

1		(209)
2		(513)
3		(405)

↕ 5.4 cm ↔ 5.1 cm



No.7 **6 min**

1		(209)
2		(513)
3		(405)

↕ 5.4 cm ↔ 5.6 cm



No.12 **8 min**

1		(209)
2		(513)
3		(405)

↕ 5.4 cm ↔ 6.8 cm



No.3 **4 min**

1		(209)
2		(513)
3		(405)

↕ 5.4 cm ↔ 4.8 cm



No.8 **7 min**

1		(209)
2		(513)
3		(405)

↕ 5.7 cm ↔ 5.3 cm



No.13 **5 min**

1		(209)
2		(513)
3		(405)

↕ 5.6 cm ↔ 5.6 cm



No.4 **5 min**

1		(209)
2		(513)
3		(405)

↕ 5.6 cm ↔ 5.0 cm



No.9 **3 min**

1		(209)
2		(513)
3		(405)

↕ 5.4 cm ↔ 2.7 cm



No.14 **7 min**

1		(209)
2		(513)
3		(405)

↕ 5.4 cm ↔ 4.9 cm



No.5 **5 min**

1		(209)
2		(513)
3		(405)

↕ 5.4 cm ↔ 5.0 cm



No.10 **6 min**

1		(209)
2		(513)
3		(405)

↕ 5.4 cm ↔ 5.7 cm



No.15 **5 min**

1		(209)
2		(513)
3		(405)

↕ 5.7 cm ↔ 5.3 cm

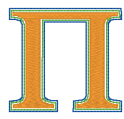

No.16

6 min	
1	Orange (209)
2	Green (513)
3	Blue (405)
↕ 5.4 cm ↔ 5.9 cm	



No.19

4 min	
1	Orange (209)
2	Green (513)
3	Blue (405)
↕ 5.4 cm ↔ 4.8 cm	



No.22

6 min	
1	Orange (209)
2	Green (513)
3	Blue (405)
↕ 5.4 cm ↔ 5.7 cm	



No.17

5 min	
1	Orange (209)
2	Green (513)
3	Blue (405)
↕ 5.4 cm ↔ 4.4 cm	



No.20

5 min	
1	Orange (209)
2	Green (513)
3	Blue (405)
↕ 5.4 cm ↔ 5.6 cm	



No.23

6 min	
1	Orange (209)
2	Green (513)
3	Blue (405)
↕ 5.4 cm ↔ 6.2 cm	



No.18

5 min	
1	Orange (209)
2	Green (513)
3	Blue (405)
↕ 5.4 cm ↔ 4.9 cm	



No.21

7 min	
1	Orange (209)
2	Green (513)
3	Blue (405)
↕ 5.4 cm ↔ 5.6 cm	



No.24

7 min	
1	Orange (209)
2	Green (513)
3	Blue (405)
↕ 5.6 cm ↔ 5.3 cm	

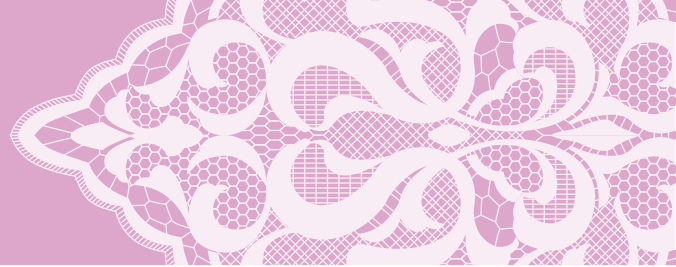

Floral alphabet patterns
Bloemletterpatronen

Blumenalphabet
Alfabeto floreale

Motifs alphabet floral
Patrones alfabéticas en motivo floral

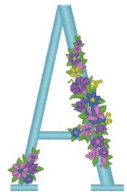

No.1 15 min

1	(017)
2	(513)
3	(810)
4	(070)
5	(612)
6	(205)

↓ 12.6 cm ↔ 7.9 cm

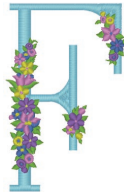

No.6 20 min

1	(017)
2	(513)
3	(070)
4	(810)
5	(205)
6	(612)

↓ 12.6 cm ↔ 8.1 cm

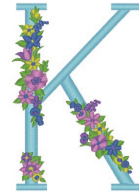

No.11 19 min

1	(017)
2	(513)
3	(810)
4	(612)
5	(205)
6	(070)

↓ 12.6 cm ↔ 8.8 cm

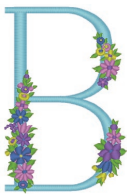

No.2 18 min

1	(017)
2	(513)
3	(810)
4	(205)
5	(070)
6	(612)

↓ 12.7 cm ↔ 8.3 cm



No.7 17 min

1	(017)
2	(513)
3	(205)
4	(612)
5	(070)
6	(810)

↓ 12.7 cm ↔ 8.4 cm

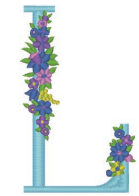

No.12 13 min

1	(017)
2	(513)
3	(810)
4	(205)
5	(612)
6	(070)

↓ 12.6 cm ↔ 7.7 cm



No.3 15 min

1	(017)
2	(513)
3	(810)
4	(205)
5	(612)
6	(070)

↓ 12.6 cm ↔ 8.2 cm



No.8 18 min

1	(017)
2	(513)
3	(612)
4	(810)
5	(205)
6	(070)

↓ 12.6 cm ↔ 9.0 cm

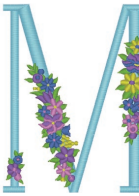

No.13 25 min

1	(017)
2	(513)
3	(205)
4	(612)
5	(810)
6	(070)

↓ 12.6 cm ↔ 10.4 cm

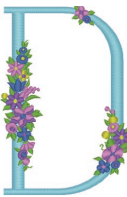

No.4 17 min

1	(017)
2	(513)
3	(205)
4	(810)
5	(612)
6	(070)

↓ 12.7 cm ↔ 8.6 cm



No.9 10 min

1	(017)
2	(513)
3	(612)
4	(810)
5	(070)
6	(205)

↓ 12.6 cm ↔ 2.6 cm

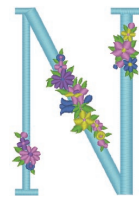

No.14 17 min

1	(017)
2	(513)
3	(070)
4	(810)
5	(612)
6	(205)

↓ 12.6 cm ↔ 8.7 cm



No.5 21 min

1	(017)
2	(513)
3	(810)
4	(070)
5	(612)
6	(205)

↓ 12.6 cm ↔ 8.6 cm



No.10 10 min

1	(017)
2	(513)
3	(612)
4	(810)
5	(070)
6	(205)

↓ 12.6 cm ↔ 5.0 cm



No.15 16 min

1	(017)
2	(513)
3	(612)
4	(810)
5	(070)
6	(205)

↓ 12.5 cm ↔ 9.5 cm

Embroidery Pattern Color Change Table
 Stickmuster-Farbtabelle
 Tableau de changement de couleur des motifs de broderie
 Kleurwijzigingstabel voor de borduurpatronen
 Tabella di cambiamento colori degli schemi di ricamo
 Tabla de cambio de color para patrones de bordado

No.16 **13 min**



1	(017)
2	(513)
3	(810)
4	(070)
5	(205)
6	(612)

↕ 12.6 cm ↔ 7.3 cm

No.20 **14 min**

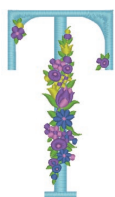

1	(017)
2	(513)
3	(810)
4	(205)
5	(612)
6	(070)

↕ 12.6 cm ↔ 7.0 cm

No.24 **17 min**

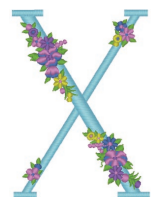

1	(017)
2	(513)
3	(070)
4	(810)
5	(205)
6	(612)

↕ 12.6 cm ↔ 9.2 cm

No.17 **21 min**



1	(017)
2	(513)
3	(810)
4	(612)
5	(205)
6	(070)

↕ 12.9 cm ↔ 9.5 cm

No.21 **13 min**

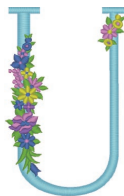

1	(017)
2	(513)
3	(810)
4	(612)
5	(070)
6	(205)

↕ 12.6 cm ↔ 8.0 cm

No.25 **14 min**



1	(017)
2	(513)
3	(070)
4	(810)
5	(612)
6	(205)

↕ 12.6 cm ↔ 8.5 cm

No.18 **18 min**



1	(017)
2	(513)
3	(612)
4	(070)
5	(810)
6	(205)

↕ 12.6 cm ↔ 8.3 cm

No.22 **13 min**



1	(017)
2	(513)
3	(810)
4	(070)
5	(612)
6	(205)

↕ 12.6 cm ↔ 7.8 cm

No.26 **15 min**



1	(017)
2	(513)
3	(810)
4	(205)
5	(612)
6	(070)

↕ 12.6 cm ↔ 7.0 cm

No.19 **15 min**



1	(017)
2	(513)
3	(810)
4	(612)
5	(205)
6	(070)

↕ 12.6 cm ↔ 7.0 cm

No.23 **24 min**



1	(017)
2	(513)
3	(612)
4	(810)
5	(070)
6	(205)

↕ 12.6 cm ↔ 11.9 cm

No.27 **6 min**



1	(017)
---	-------

↕ 8.0 cm ↔ 5.9 cm

No.30 **7 min**



1	(017)
---	-------

↕ 12.6 cm ↔ 6.1 cm

No.33 **10 min**



1	(017)
---	-------

↕ 12.6 cm ↔ 8.6 cm

No.36 **5 min**



1	(017)
---	-------

↕ 15.8 cm ↔ 4.0 cm

No.28 **7 min**



1	(017)
---	-------

↕ 12.6 cm ↔ 6.1 cm

No.31 **6 min**



1	(017)
---	-------

↕ 8.3 cm ↔ 5.7 cm

No.34 **7 min**



1	(017)
---	-------

↕ 12.6 cm ↔ 6.3 cm

No.37 **7 min**



1	(017)
---	-------

↕ 12.6 cm ↔ 6.6 cm

No.29 **4 min**



1	(017)
---	-------

↕ 8.3 cm ↔ 5.6 cm

No.32 **5 min**



1	(017)
---	-------

↕ 12.6 cm ↔ 5.5 cm

No.35 **3 min**



1	(017)
---	-------

↕ 11.0 cm ↔ 1.9 cm

No.38 **4 min**



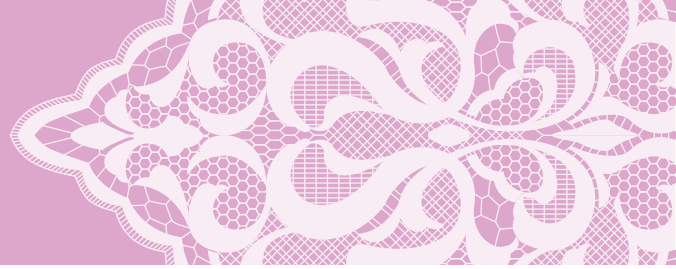

1	(017)
---	-------

↕ 12.6 cm ↔ 2.0 cm





No.39 **9 min**
 1  (017)
 ⇅ 8.0 cm ↔ 9.0 cm

No.43 **8 min**
 1  (017)
 ⇅ 12.6 cm ↔ 6.9 cm

No.47 **6 min**
 1  (017)
 ⇅ 8.0 cm ↔ 6.5 cm

No.51 **7 min**
 1  (017)
 ⇅ 12.6 cm ↔ 8.5 cm

No.40 **6 min**
 1  (017)
 ⇅ 8.0 cm ↔ 6.5 cm

No.44 **4 min**
 1  (017)
 ⇅ 8.1 cm ↔ 5.4 cm

No.48 **4 min**
 1  (017)
 ⇅ 8.0 cm ↔ 5.7 cm

No.52 **5 min**
 1  (017)
 ⇅ 8.0 cm ↔ 5.2 cm

No.41 **6 min**
 1  (017)
 ⇅ 8.2 cm ↔ 5.6 cm





No.45 **6 min**
 1  (017)
 ⇅ 8.1 cm ↔ 5.0 cm





No.49 **7 min**
 1  (017)
 ⇅ 8.0 cm ↔ 8.2 cm



No.42 **8 min**
 1  (017)
 ⇅ 12.6 cm ↔ 6.9 cm

No.46 **5 min**
 1  (017)
 ⇅ 12.7 cm ↔ 5.2 cm





No.50 **4 min**
 1  (017)
 ⇅ 8.0 cm ↔ 6.0 cm





No.53 **5 min**
 1  (513)
 2  (612)
 3  (810)
 4  (070)
 5  (205)
 ⇅ 9.5 cm ↔ 2.5 cm

No.56 **1 min**
 1  (513)
 2  (810)
 3  (070)
 4  (612)
 ⇅ 2.6 cm ↔ 2.4 cm











No.57 **1 min**
 1  (513)
 2  (070)
 3  (810)
 ⇅ 1.8 cm ↔ 1.3 cm







No.59 **8 min**
 1  (513)
 2  (070)
 3  (810)
 4  (612)
 5  (205)
 ⇅ 7.6 cm ↔ 9.6 cm





No.54 **3 min**
 1  (513)
 2  (810)
 3  (612)
 4  (205)
 5  (070)
 ⇅ 4.8 cm ↔ 2.1 cm







No.58 **40 min**
 1  (513)
 2  (070)
 3  (124)
 4  (086)
 5  (205)
 6  (513)
 7  (070)
 8  (124)
 9  (086)
 10  (205)
 ⇅ 23.9 cm ↔ 19.9 cm



No.60 **7 min**
 1  (513)
 2  (070)
 3  (810)
 4  (612)
 5  (205)
 ⇅ 3.8 cm ↔ 10.9 cm

No.55 **1 min**
 1  (513)
 2  (810)
 3  (205)
 4  (612)
 ⇅ 2.6 cm ↔ 1.7 cm



No.61 **7 min**
 1  (513)
 2  (070)
 3  (810)
 4  (612)
 5  (205)
 ⇅ 4.2 cm ↔ 8.0 cm

Utility embroidery patterns

Nutzstich-Stickmuster

Motifs de broderie courants



Borduurnaaipatronen





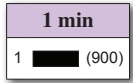



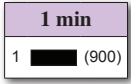
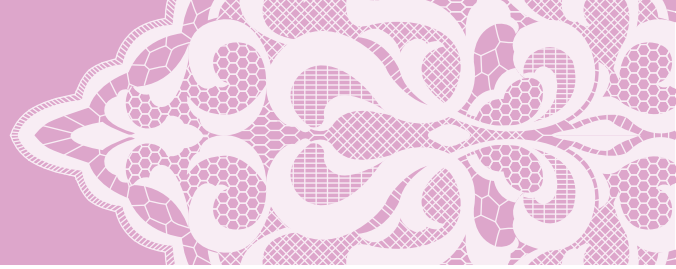







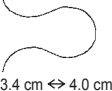







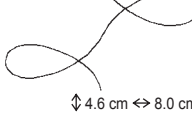







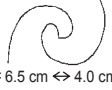







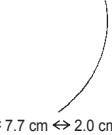









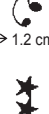



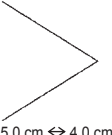





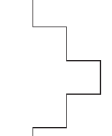

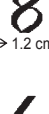



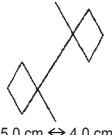







Disegni da ricamo utili

Patrones de bordado de utilidad



No.1	No.9	No.18	No.27	No.36	No.45	No.54	No.63
↕ 3.2 cm ↔ 0.0 cm	↕ 3.6 cm ↔ 0.7 cm	↕ 2.7 cm ↔ 0.7 cm	↕ 3.2 cm ↔ 1.2 cm	↕ 3.4 cm ↔ 0.8 cm	↕ 4.8 cm ↔ 0.7 cm	↕ 3.9 cm ↔ 1.2 cm	↕ 4.2 cm ↔ 1.4 cm
No.2	No.10	No.19	No.28	No.37	No.46	No.55	No.64
↕ 3.0 cm ↔ 0.3 cm	↕ 3.4 cm ↔ 0.7 cm	↕ 3.9 cm ↔ 1.2 cm	↕ 3.1 cm ↔ 1.2 cm	↕ 3.9 cm ↔ 0.8 cm	↕ 4.8 cm ↔ 0.8 cm	↕ 5.1 cm ↔ 1.2 cm	↕ 4.3 cm ↔ 1.5 cm
No.3	No.11	No.20	No.29	No.38	No.47	No.56	No.65
↕ 3.5 cm ↔ 0.4 cm	↕ 3.6 cm ↔ 0.7 cm	↕ 3.8 cm ↔ 0.8 cm	↕ 4.2 cm ↔ 1.2 cm	↕ 4.7 cm ↔ 1.2 cm	↕ 8.2 cm ↔ 1.9 cm	↕ 3.2 cm ↔ 0.7 cm	↕ 5.5 cm ↔ 1.3 cm
No.4	No.12	No.21	No.30	No.39	No.48	No.57	No.66
↕ 3.3 cm ↔ 0.7 cm	↕ 3.3 cm ↔ 0.7 cm	↕ 3.8 cm ↔ 0.8 cm	↕ 4.2 cm ↔ 1.3 cm	↕ 5.5 cm ↔ 1.2 cm	↕ 5.6 cm ↔ 1.2 cm	↕ 3.7 cm ↔ 1.2 cm	↕ 4.8 cm ↔ 1.5 cm
No.5	No.13	No.22	No.31	No.40	No.49	No.58	No.67
↕ 3.4 cm ↔ 0.7 cm	↕ 3.9 cm ↔ 1.2 cm	↕ 3.2 cm ↔ 0.8 cm	↕ 3.4 cm ↔ 1.0 cm	↕ 5.7 cm ↔ 1.1 cm	↕ 3.4 cm ↔ 1.2 cm	↕ 5.8 cm ↔ 1.2 cm	↕ 7.2 cm ↔ 1.7 cm
No.6	No.14	No.23	No.32	No.41	No.50	No.59	No.68
↕ 3.5 cm ↔ 0.6 cm	↕ 3.0 cm ↔ 0.9 cm	↕ 3.2 cm ↔ 1.2 cm	↕ 3.3 cm ↔ 0.9 cm	↕ 4.8 cm ↔ 1.2 cm	↕ 3.5 cm ↔ 1.2 cm	↕ 3.5 cm ↔ 1.6 cm	↕ 5.1 cm ↔ 1.4 cm
No.7	No.15	No.24	No.33	No.42	No.51	No.60	No.69
↕ 3.3 cm ↔ 0.5 cm	↕ 3.7 cm ↔ 0.9 cm	↕ 3.4 cm ↔ 0.7 cm	↕ 3.5 cm ↔ 0.8 cm	↕ 4.5 cm ↔ 0.7 cm	↕ 3.8 cm ↔ 1.2 cm	↕ 3.3 cm ↔ 0.9 cm	↕ 4.6 cm ↔ 4.6 cm
No.8	No.16	No.25	No.34	No.43	No.52	No.61	No.70
↕ 3.8 cm ↔ 0.3 cm	↕ 3.2 cm ↔ 1.2 cm	↕ 6.6 cm ↔ 1.2 cm	↕ 3.2 cm ↔ 0.5 cm	↕ 4.4 cm ↔ 0.7 cm	↕ 3.4 cm ↔ 1.2 cm	↕ 4.8 cm ↔ 2.0 cm	↕ 3.6 cm ↔ 1.2 cm
	No.17	No.26	No.35	No.44	No.53	No.62	No.71
	↕ 3.4 cm ↔ 1.2 cm	↕ 3.6 cm ↔ 0.9 cm	↕ 3.4 cm ↔ 0.4 cm	↕ 4.0 cm ↔ 0.7 cm	↕ 3.3 cm ↔ 0.7 cm	↕ 4.8 cm ↔ 2.2 cm	↕ 2.8 cm ↔ 4.0 cm



	No.80  ↕ 3.1 cm ↔ 0.9 cm	No.91  ↕ 4.5 cm ↔ 1.5 cm	No.102  ↕ 6.3 cm ↔ 1.8 cm	No.113  ↕ 4.5 cm ↔ 1.0 cm	No.124  ↕ 3.4 cm ↔ 0.7 cm	No.135  ↕ 3.2 cm ↔ 0.4 cm	No.146  ↕ 3.6 cm ↔ 1.0 cm
No.72  ↕ 3.4 cm ↔ 4.0 cm	No.81  ↕ 4.9 cm ↔ 0.9 cm	No.92  ↕ 5.7 cm ↔ 2.5 cm	No.103  ↕ 4.9 cm ↔ 1.8 cm	No.114  ↕ 3.0 cm ↔ 0.9 cm	No.125  ↕ 3.4 cm ↔ 0.7 cm	No.136  ↕ 3.0 cm ↔ 0.5 cm	No.147  ↕ 3.2 cm ↔ 0.8 cm
No.73  ↕ 4.6 cm ↔ 8.0 cm	No.82  ↕ 5.7 cm ↔ 0.9 cm	No.93  ↕ 3.0 cm ↔ 1.0 cm	No.104  ↕ 3.9 cm ↔ 1.3 cm	No.115  ↕ 3.5 cm ↔ 0.7 cm	No.126  ↕ 5.0 cm ↔ 0.6 cm	No.137  ↕ 3.2 cm ↔ 0.8 cm	No.148  ↕ 3.2 cm ↔ 0.8 cm
No.74  ↕ 6.5 cm ↔ 4.0 cm	No.83  ↕ 3.6 cm ↔ 0.9 cm	No.94  ↕ 3.6 cm ↔ 1.8 cm	No.105  ↕ 4.9 cm ↔ 1.0 cm	No.116  ↕ 6.0 cm ↔ 0.9 cm	No.127  ↕ 3.0 cm ↔ 0.7 cm	No.138  ↕ 4.2 cm ↔ 1.2 cm	No.149  ↕ 3.6 cm ↔ 0.6 cm
No.75  ↕ 7.7 cm ↔ 2.0 cm	No.84  ↕ 3.2 cm ↔ 1.0 cm	No.95  ↕ 4.2 cm ↔ 0.9 cm	No.106  ↕ 3.6 cm ↔ 1.0 cm	No.117  ↕ 4.2 cm ↔ 0.7 cm	No.128  ↕ 3.4 cm ↔ 0.7 cm	No.139  ↕ 3.0 cm ↔ 0.9 cm	No.150  ↕ 3.0 cm ↔ 1.0 cm
No.76  ↕ 8.6 cm ↔ 4.2 cm	No.85  ↕ 3.7 cm ↔ 2.0 cm	No.96  ↕ 3.8 cm ↔ 0.8 cm	No.107  ↕ 5.3 cm ↔ 1.2 cm	No.118  ↕ 4.0 cm ↔ 0.9 cm	No.129  ↕ 2.6 cm ↔ 0.7 cm	No.140  ↕ 3.0 cm ↔ 0.6 cm	
No.77  ↕ 5.0 cm ↔ 4.0 cm	No.86  ↕ 3.4 cm ↔ 2.0 cm	No.97  ↕ 3.2 cm ↔ 0.7 cm	No.108  ↕ 3.8 cm ↔ 0.9 cm	No.119  ↕ 3.8 cm ↔ 0.9 cm	No.130  ↕ 3.4 cm ↔ 0.7 cm	No.141  ↕ 3.2 cm ↔ 0.6 cm	
No.78  ↕ 8.4 cm ↔ 4.2 cm	No.87  ↕ 3.6 cm ↔ 2.0 cm	No.98  ↕ 3.0 cm ↔ 1.0 cm	No.109  ↕ 3.6 cm ↔ 1.3 cm	No.120  ↕ 3.6 cm ↔ 0.9 cm	No.131  ↕ 4.2 cm ↔ 0.7 cm	No.142  ↕ 5.2 cm ↔ 1.0 cm	
No.79  ↕ 5.0 cm ↔ 4.0 cm	No.88  ↕ 3.8 cm ↔ 2.1 cm	No.99  ↕ 2.8 cm ↔ 1.1 cm	No.110  ↕ 3.0 cm ↔ 1.2 cm	No.121  ↕ 3.4 cm ↔ 0.7 cm	No.132  ↕ 3.7 cm ↔ 0.8 cm	No.143  ↕ 3.0 cm ↔ 0.6 cm	
	No.89  ↕ 3.6 cm ↔ 2.0 cm	No.100  ↕ 4.2 cm ↔ 0.9 cm	No.111  ↕ 3.2 cm ↔ 0.9 cm	No.122  ↕ 3.4 cm ↔ 0.6 cm	No.133  ↕ 3.1 cm ↔ 0.7 cm	No.144  ↕ 3.2 cm ↔ 0.6 cm	
	No.90  ↕ 4.0 cm ↔ 2.0 cm	No.101  ↕ 3.9 cm ↔ 2.0 cm	No.112  ↕ 3.5 cm ↔ 1.2 cm	No.123  ↕ 4.0 cm ↔ 0.7 cm	No.134  ↕ 3.0 cm ↔ 0.3 cm	No.145  ↕ 3.6 cm ↔ 0.6 cm	

Embroidery Pattern Color Change Table
Stickmuster-Farbtabelle
Tableau de changement de couleur des motifs de broderie
Kleurwijzigingstabel voor de borduurpatronen
Tabella di cambiamento colori degli schemi di ricamo
Tabla de cambio de color para patrones de bordado

Patterns for bobbin work

Stickmuster für Bobbin Work

Motifs pour le travail à la canette

Patronen voor werken met de spoel

Disegni per ricamo con spolina

Patrones para efectos decorativos con bobinas

Note : Embroidery patterns for bobbin work are reversed when they have been sewn.

Hinweis : Stickmuster für Bobbin Work werden nach dem Nähen umgedreht.

Remarque : Les motifs de broderie pour le travail à la canette sont inversés lorsqu'ils sont cousus.

Opmerking : Borduurpatronen voor het werken met de spoel worden omgekeerd nadat deze zijn gemaakt.

Nota : I motivi per il ricamo con spolina vengono capovolti durante la cucitura.

Nota : Los patrones de bordado para efectos decorativos con bobinas se invierten una vez cosidos.

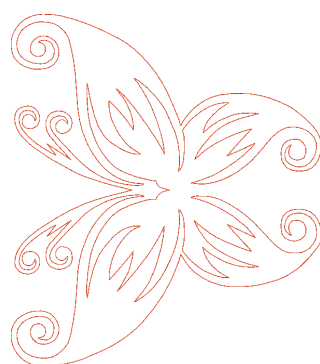

No.151



4 min	
1	(030)
↕ 22.4 cm ↔ 19.9 cm	
 4.5 m (3.9 m + 0.6 m)	

Total length of thread needed to sew the pattern (to sew the pattern + to tie ends)

Erforderliche Gesamtfadenlänge zum Nähen des Musters (Muster nähen + Enden verknoten)

Longueur totale de fil nécessaire pour coudre le motif (coudre le motif + nouer les extrémités)

Totale lengte van de draad die nodig is om het patroon te maken (patroon naaien + uiteinden vastknopen)

Lunghezza totale del filo necessaria per la cucitura del motivo (cucire il motivo + annodare le estremità)

Longitud total de hilo necesario para coser el patrón (coser el patrón + atar los extremos)



No.152



1 min	
1	(030)
↕ 17.5 cm ↔ 9.7 cm	
 1.5 m (0.9 m + 0.6 m)	



No.155



2 min	
1	(030)
↕ 19.6 cm ↔ 9.8 cm	
 2.3 m (1.7 m + 0.6 m)	



No.153



1 min	
1	(509)
↕ 12.4 cm ↔ 12.7 cm	
 1.6 m (1.0 m + 0.6 m)	



No.156



1 min	
1	(405)
↕ 17.5 cm ↔ 10.4 cm	
 1.8 m (1.2 m + 0.6 m)	

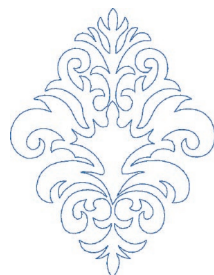

No.154



3 min	
1	(405)
↕ 16.5 cm ↔ 12.5 cm	
 2.8 m (2.2 m + 0.6 m)	

Refer to the operation manual for the sewing machine for details on how to embroider bobbin work patterns.

Weitere Hinweise zum Sticken von Bobbin Work finden Sie in der Bedienungsanleitung der Nähmaschine.

Reportez-vous au Manuel d'instructions de la machine à coudre pour plus de détails sur la broderie des motifs pour le travail à la canette.

Zie de bedieningshandleiding bij de naaimachine voor bijzonderheden over het borduren met de spoel.

Fare riferimento al manuale d'istruzione della macchina da cucire per i dettagli su come ricamare i disegni per il ricamo con spolina.

Para obtener más información sobre cómo bordar patrones para efectos decorativos con bobinas, consulte el manual de instrucciones de la máquina de coser.

Embroidery Pattern Color Change Table
 Stickmuster-Farbtabelle
 Tableau de changement de couleur des motifs de broderie
 Kleurwijzigingstabel voor de borduurpatronen
 Tabella di cambiamento colori degli schemi di ricamo
 Tabla de cambio de color para patrones de bordado

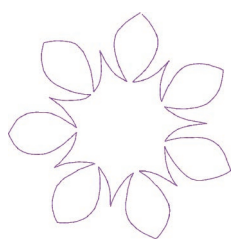
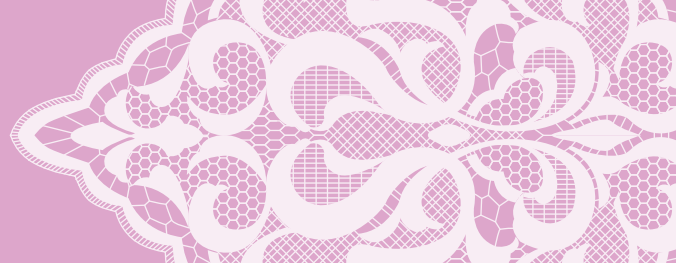

No.157

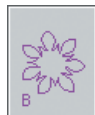

1 min	
1	(620)
↕13.6 cm ↔ 13.3 cm	
 1.6 m (1.0 m + 0.6 m)	

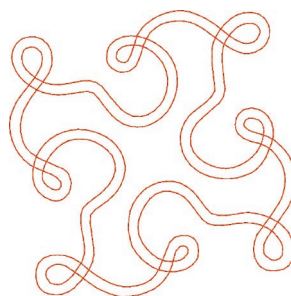

No.161



2 min	
1	(030)
↕12.6 cm ↔ 12.6 cm	
 2.4 m (1.8 m + 0.6 m)	

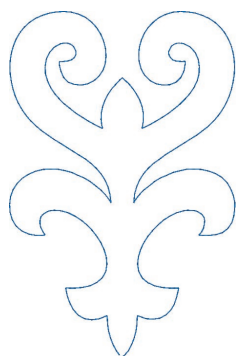

No.158

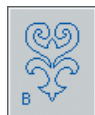

1 min	
1	(405)
↕15.4 cm ↔ 10.0 cm	
 1.6 m (1.0 m + 0.6 m)	

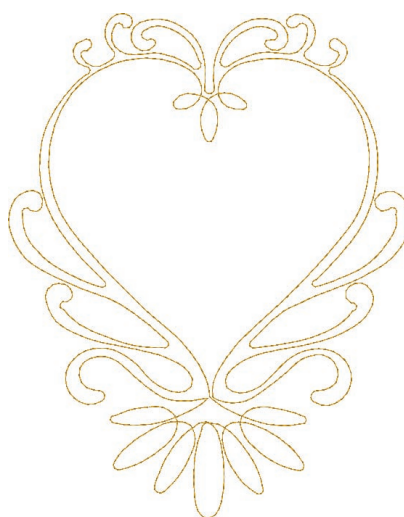

No.162



3 min	
1	(328)
↕22.4 cm ↔ 17.7 cm	
 3.5 m (2.9 m + 0.6 m)	



No.159



1 min	
1	(509)
↕6.3 cm ↔ 7.5 cm	
 1.1 m (0.5 m + 0.6 m)	



No.163



2 min	
1	(542)
↕12.4 cm ↔ 13.6 cm	
 2.7 m (2.1 m + 0.6 m)	



No.160



1 min	
1	(405)
↕7.5 cm ↔ 6.8 cm	
 1.0 m (0.4 m + 0.6 m)	



No.164



2 min	
1	(209)
↕8.2 cm ↔ 11.8 cm	
 2.2 m (1.6 m + 0.6 m)	

Examples of Combinations Exemples de combinaisons Esempi di combinazioni

Kombinationsbeispiele Voorbeelden van combinaties Ejemplos de combinaciones

Combine various embroidery patterns, as shown below, to enhance your embroidering enjoyment.
 Wenn Sie verschiedene Stickmuster wie unten dargestellt miteinander kombinieren, macht das Stickten noch mehr Spaß.
 Combinez plusieurs motifs de broderie comme indiqué ci-dessous, pour un plaisir de broderie garanti.
 Zoals hieronder aangegeven kunt u diverse borduurpatronen combineren. Zo borduurt u met nog meer plezier.
 Combinare vari disegni da ricamo, come indicato di seguito, per rendere il ricamo ancora più divertente.
 Combine distintos patrones de bordado, como se muestra a continuación, para un mayor deleite al bordar.



Positioning symbols: These symbols indicate how the embroidery patterns have been flipped or rotated to create the combined pattern.

Positionierungssymbole: Diese Symbole zeigen an, wie Stickmuster für die Musterkombination gespiegelt oder gedreht wurden.

Symboles de positionnement : Ces symboles indiquent la manière dont les motifs de broderie ont été inversés ou tournés pour créer le motif combiné.

Plaatsingsymbolen: deze symbolen geven aan hoe borduurpatronen zijn gedraaid rond een as of middelpunt om het gecombineerde patroon te creëren.

Simboli di posizionamento: questi simboli indicano la modalità di ribaltamento o rotazione dei disegni da ricamo per creare il disegno combinato.

Símbolos de colocación: estos símbolos indican cómo se han invertido o girado los patrones de bordado para crear el patrón combinado.

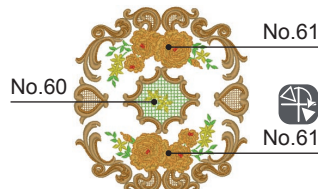
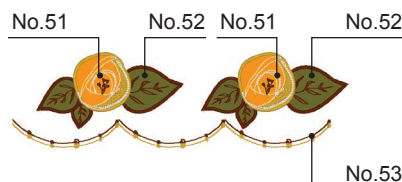
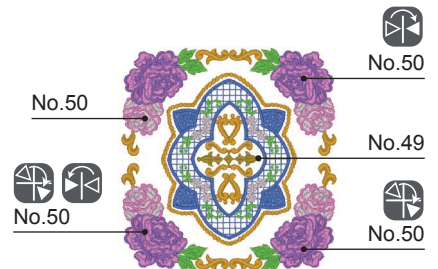
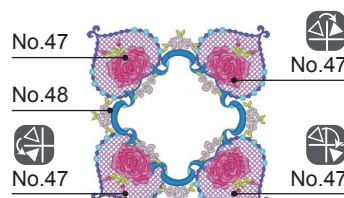
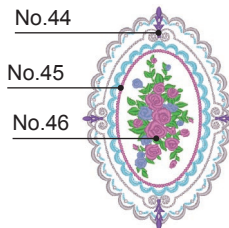
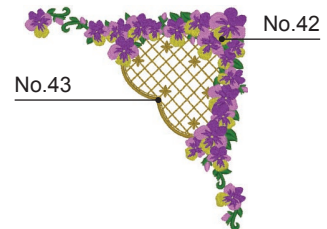
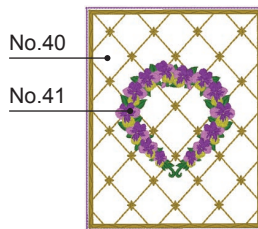
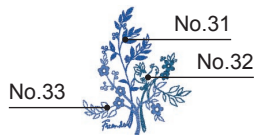
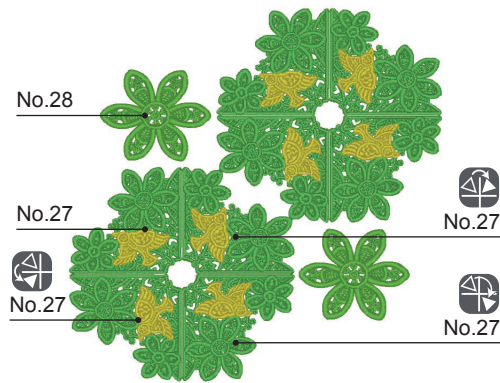
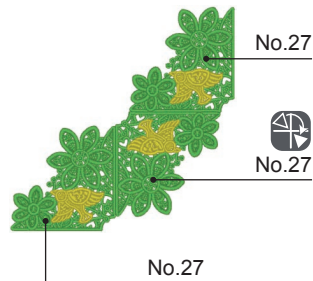

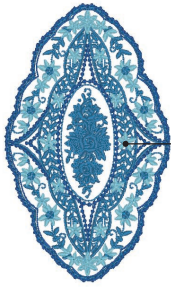
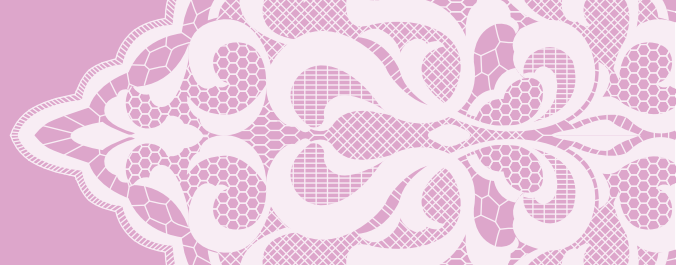

No.1

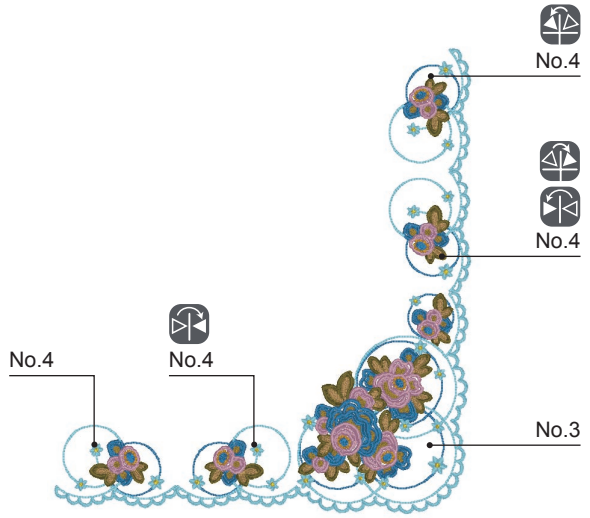

No.4

No.4

No.3

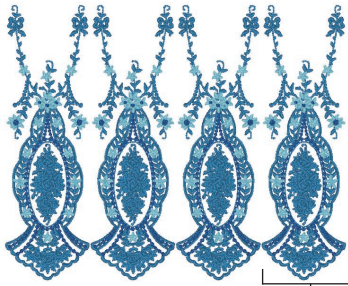

No.2x4

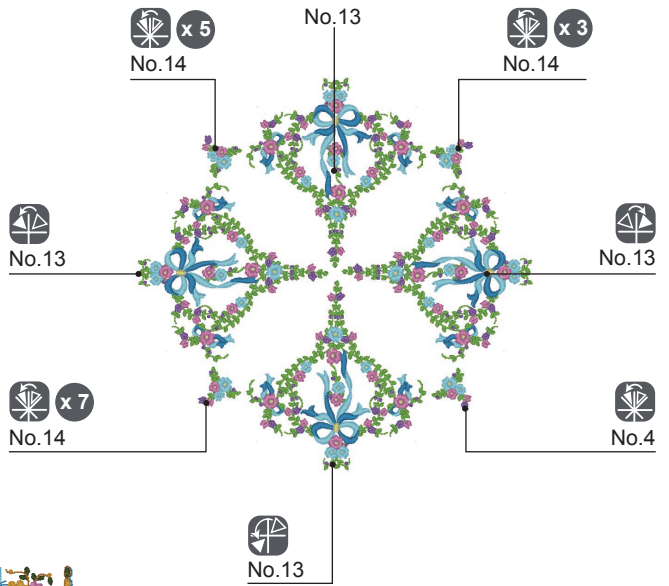

No.14 x 5

No.13

No.14 x 3

No.13

No.13

No.14 x 7

No.14

No.13

No.6x2

No.5

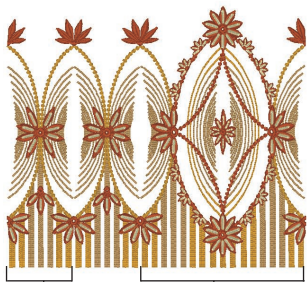
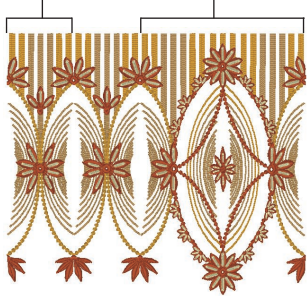

No.6x2

No.5



No.12

No.12

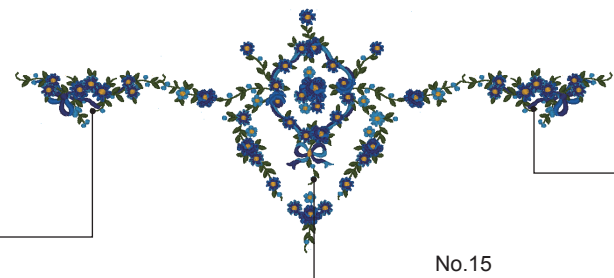

No.16

No.15

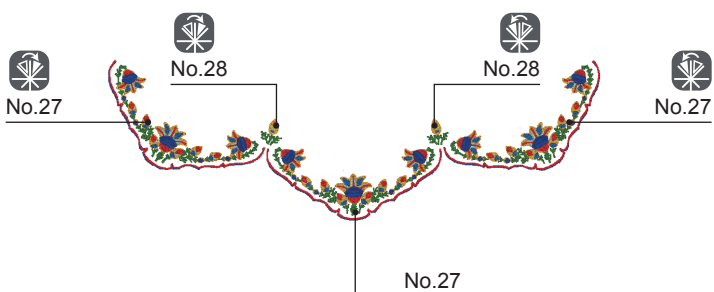
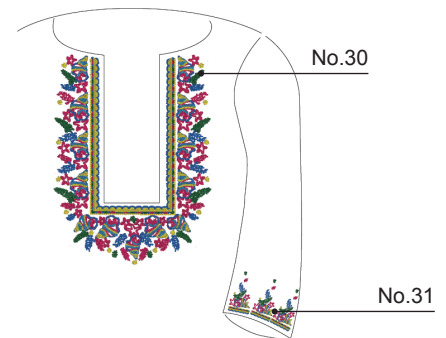
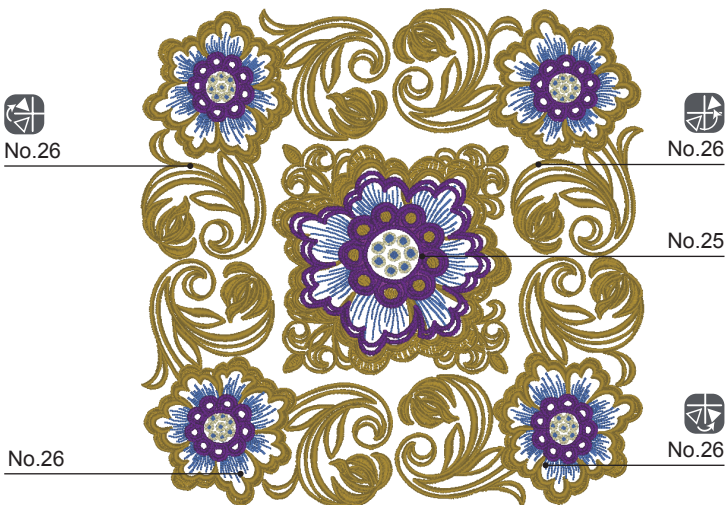
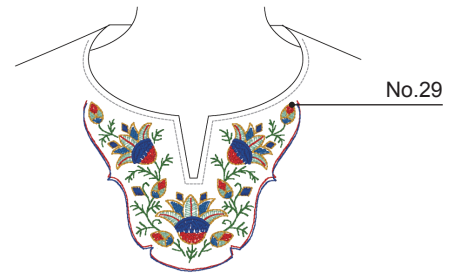
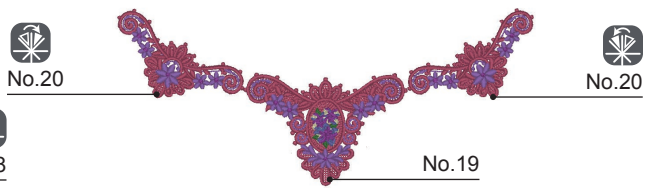

Positioning symbols: These symbols indicate how the embroidery patterns have been flipped or rotated to create the combined pattern.

Positionierungssymbole: Diese Symbole zeigen an, wie Stickmuster für die Musterkombination gespiegelt oder gedreht wurden.

Symboles de positionnement : Ces symboles indiquent la manière dont les motifs de broderie ont été inversés ou tournés pour créer le motif combiné.

Plaatsingssymbolen: deze symbolen geven aan hoe borduurpatronen zijn gedraaid rond een as of middelpunt om het gecombineerde patroon te creëren.

Simboli di posizionamento: questi simboli indicano la modalità di ribaltamento o rotazione dei disegni da ricamo per creare il disegno combinato.

Símbolos de colocación: estos símbolos indican cómo se han invertido o girado los patrones de bordado para crear el patrón combinado.

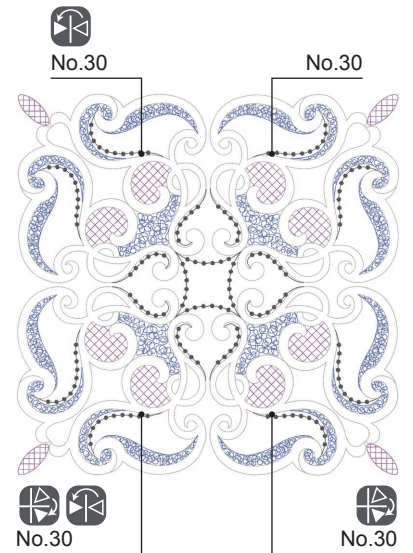
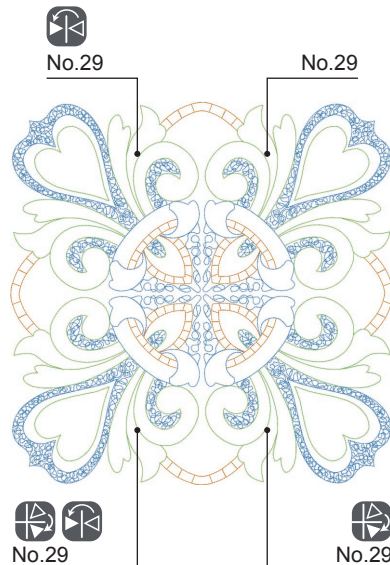
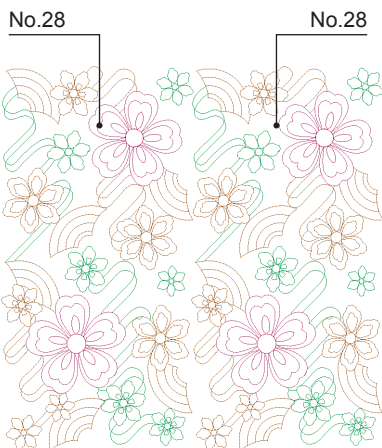
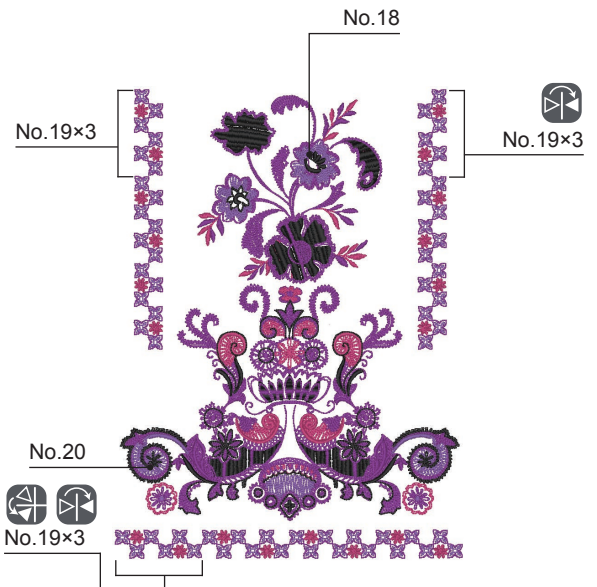
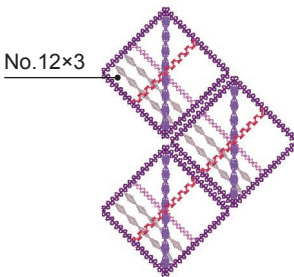
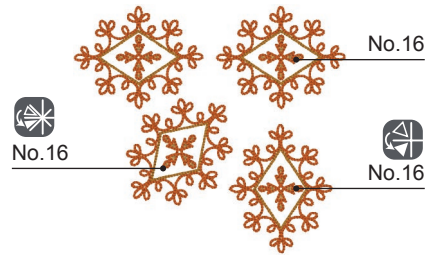
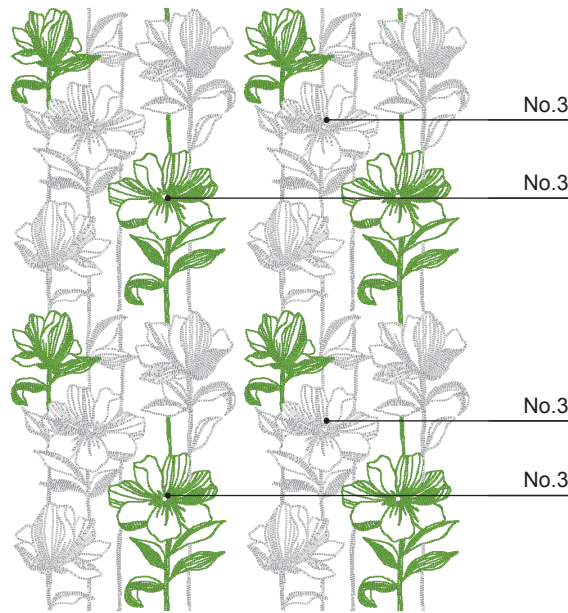

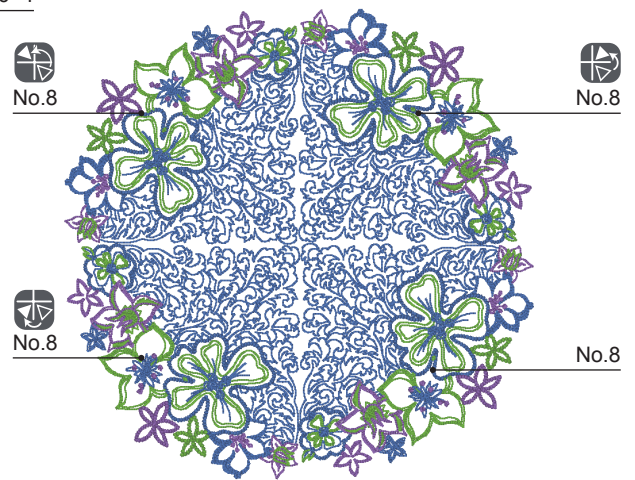
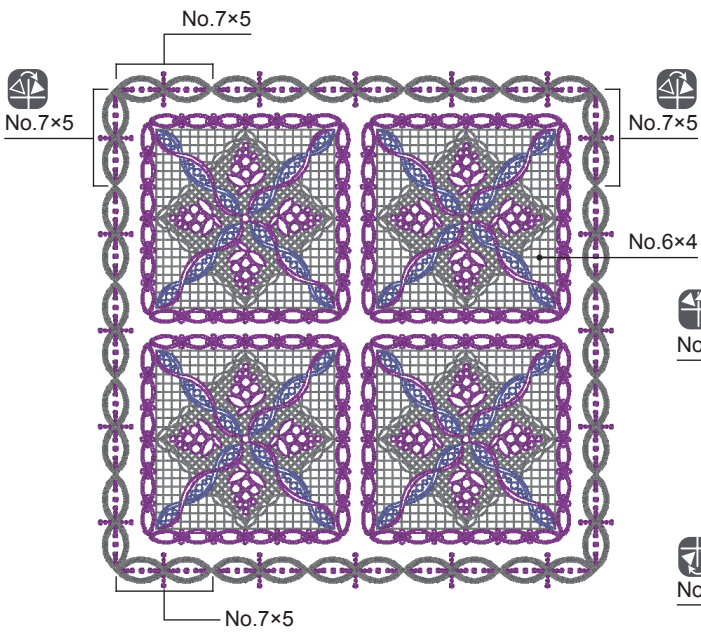
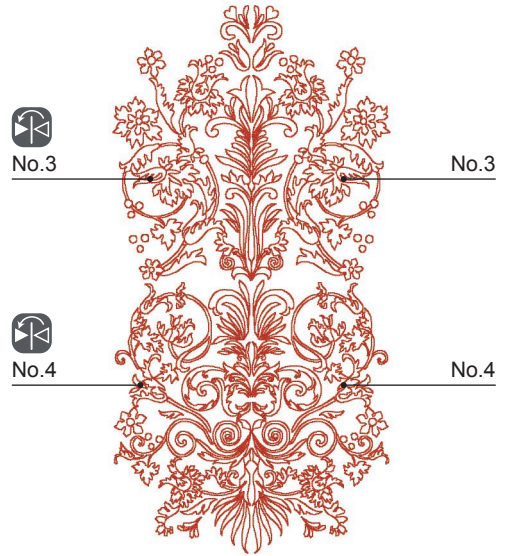
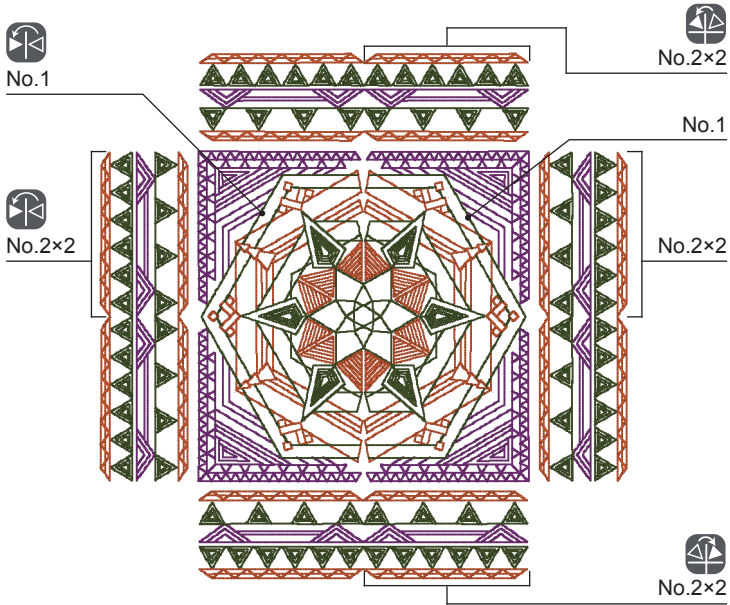
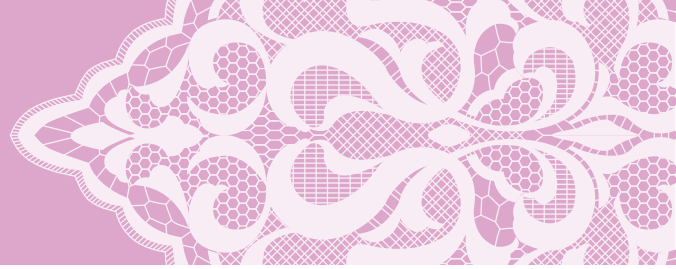

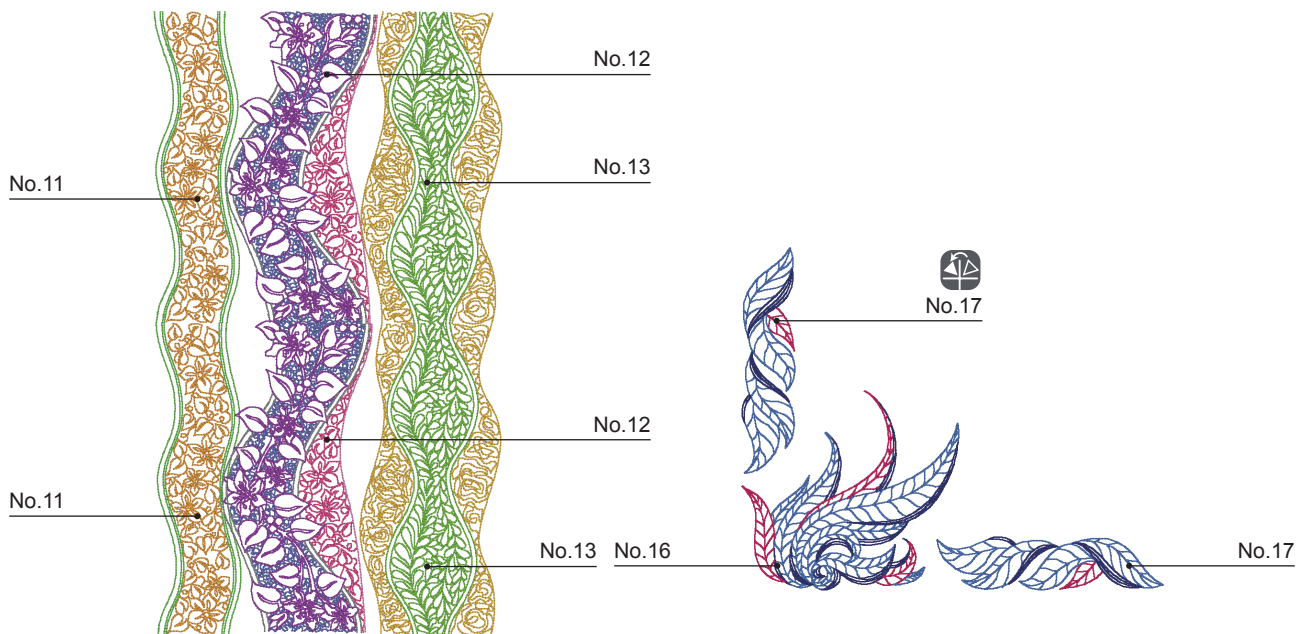
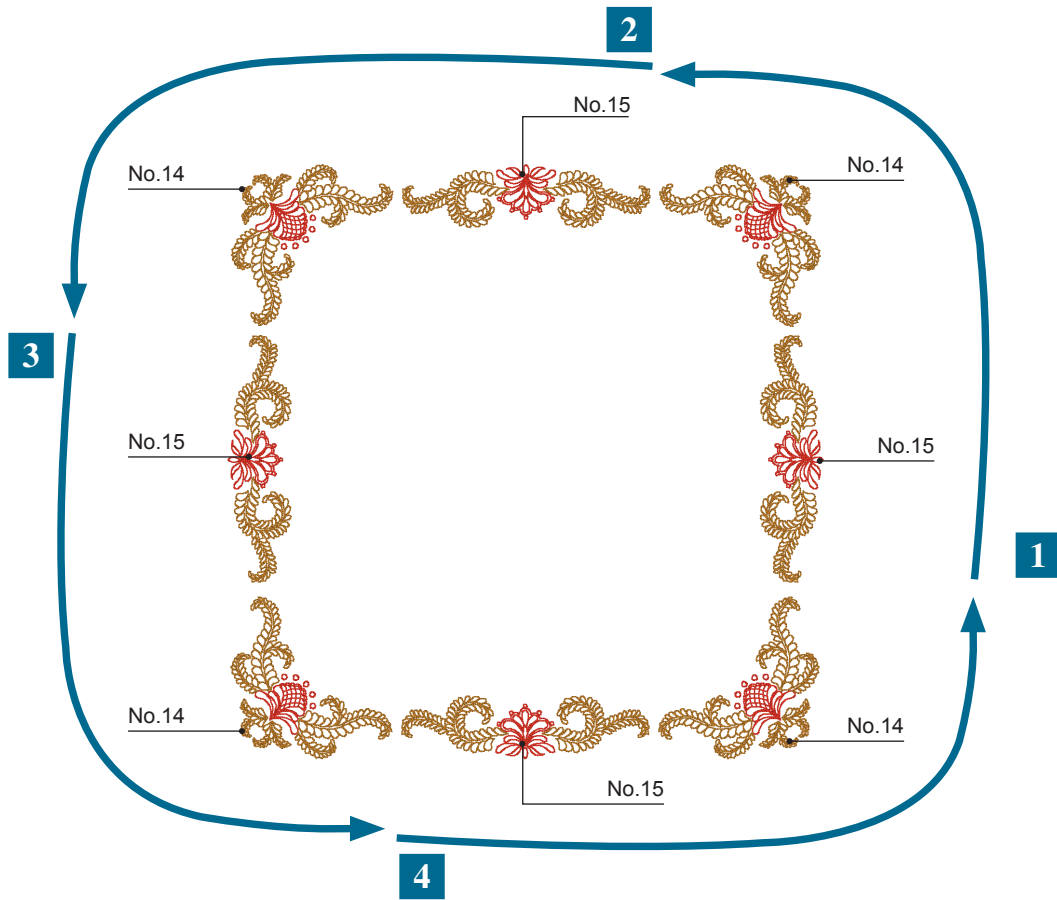

Positioning symbols: These symbols indicate how the embroidery patterns have been flipped or rotated to create the combined pattern.

Positionierungssymbole: Diese Symbole zeigen an, wie Stickmuster für die Musterkombination gespiegelt oder gedreht wurden.

Symboles de positionnement : Ces symboles indiquent la manière dont les motifs de broderie ont été inversés ou tournés pour créer le motif combiné.

Plaatsingsymbolen: deze symbolen geven aan hoe borduurpatronen zijn gedraaid rond een as of middelpunt om het gecombineerde patroon te creëren.

Simboli di posizionamento: questi simboli indicano la modalità di ribaltamento o rotazione dei disegni da ricamo per creare il disegno combinato.

Símbolos de colocación: estos símbolos indican cómo se han invertido o girado los patrones de bordado para crear el patrón combinado.

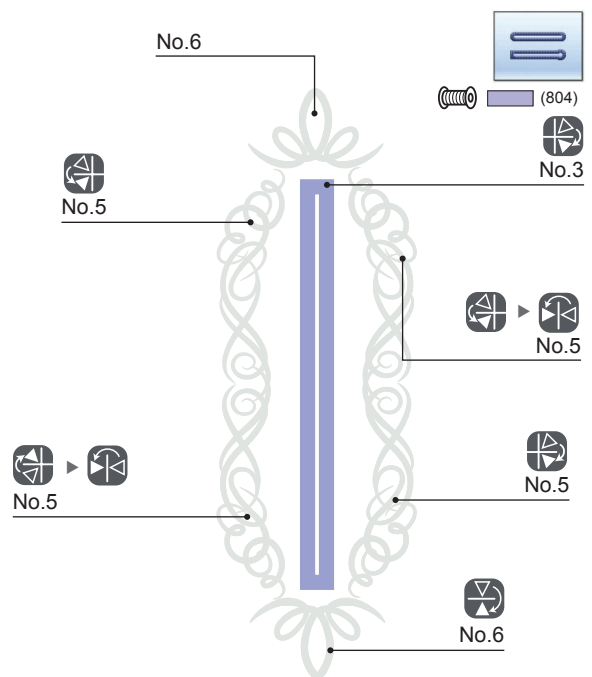
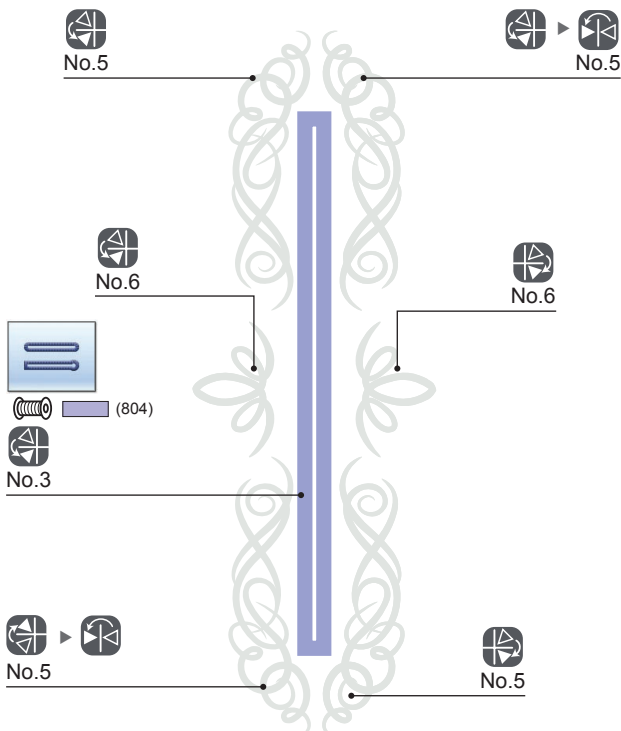
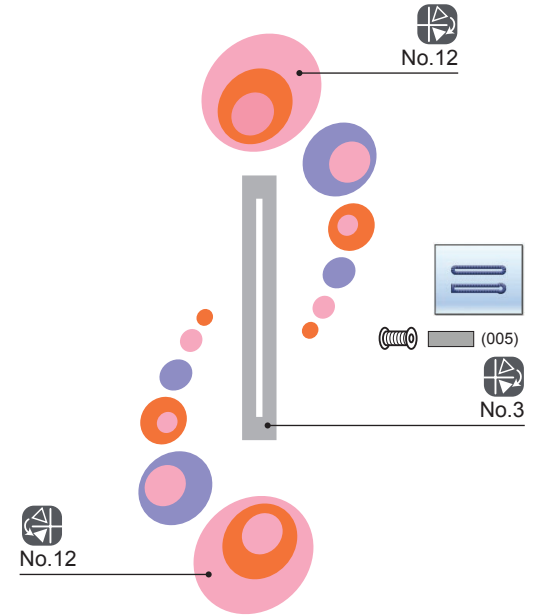
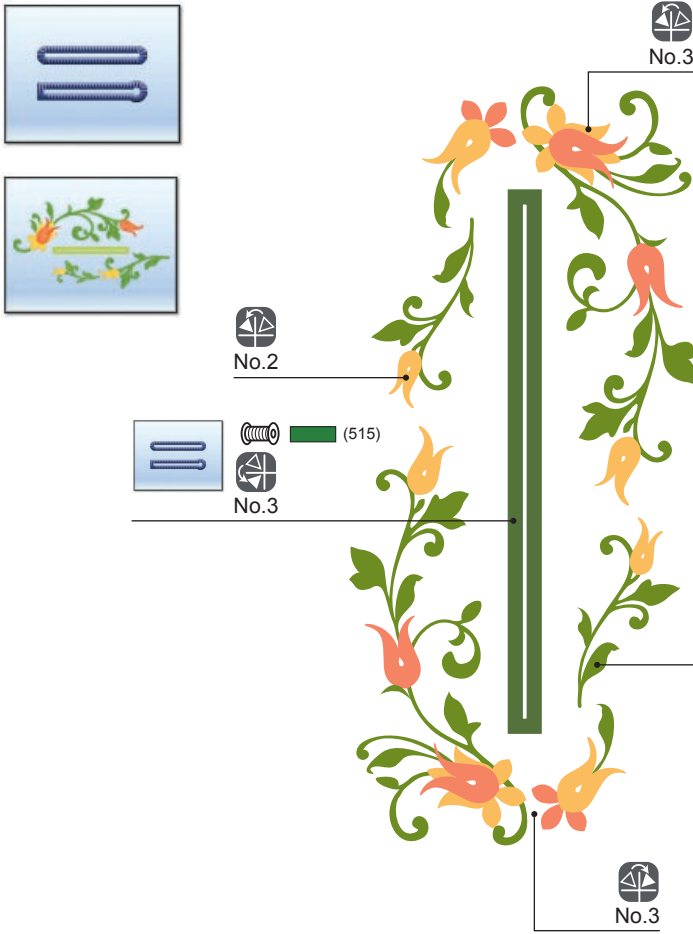
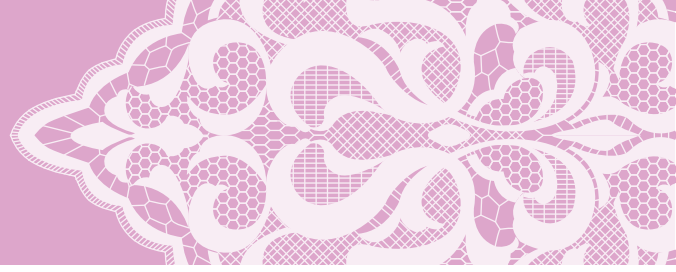

(005)
 (019)
 (017)
 ↓ 7.9 cm ↔ 3.4 cm

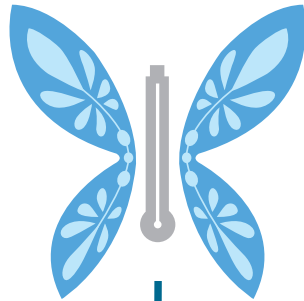

(005)
 (019)
 (017)
 (513)
 ↓ 10.0 cm ↔ 4.7 cm



(005)
 (019)
 (017)
 (513)
 (019)
 ↓ 12.6 cm ↔ 6.2 cm

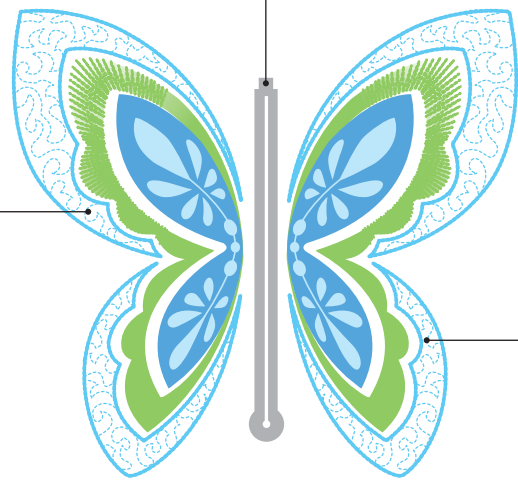

(005)
 No.12

No.13

No.13



(005)
 No.3

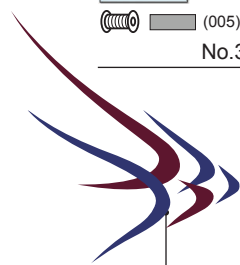

No.14



No.14

No.15



No.15



Positioning symbols: These symbols indicate how the embroidery patterns have been flipped or rotated to create the combined pattern.

Positionierungssymbole: Diese Symbole zeigen an, wie Stickmuster für die Musterkombination gespiegelt oder gedreht wurden.

Symboles de positionnement : Ces symboles indiquent la manière dont les motifs de broderie ont été inversés ou tournés pour créer le motif combiné.

Plaatsingssymbolen: deze symbolen geven aan hoe borduurpatronen zijn gedraaid rond een as of middelpunt om het gecombineerde patroon te creëren.

Simboli di posizionamento: questi simboli indicano la modalità di ribaltamento o rotazione dei disegni da ricamo per creare il disegno combinato.

Símbolos de colocación: estos símbolos indican cómo se han invertido o girado los patrones de bordado para crear el patrón combinado.

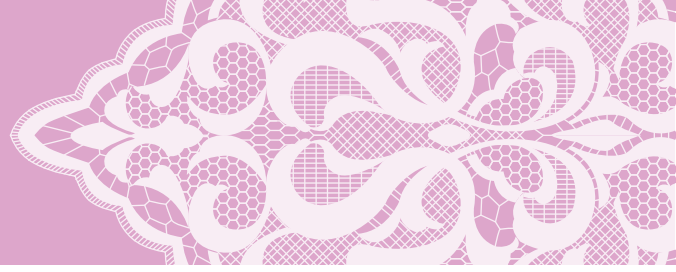

No.1

No.1 + No.2 + No.3

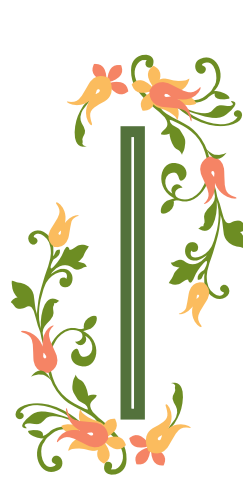

No.4



No.5 + No.6

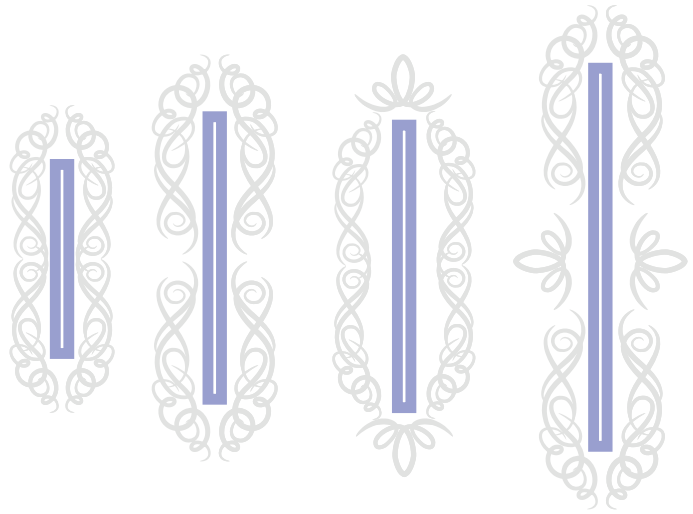

No.7

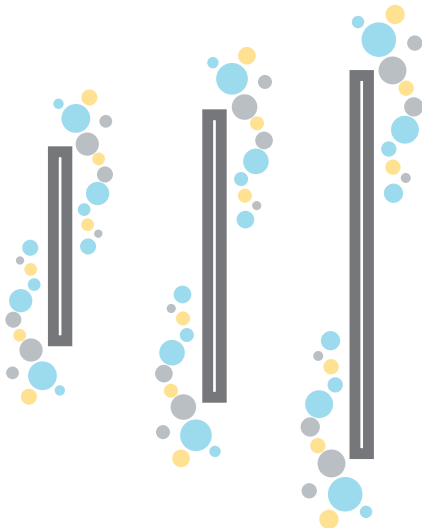

No.8

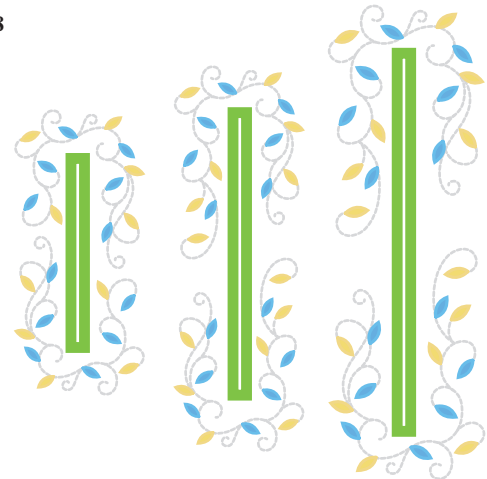

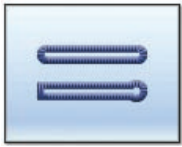
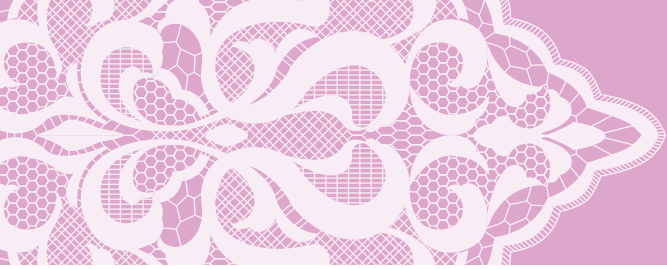

No.11

No.9 + No.10

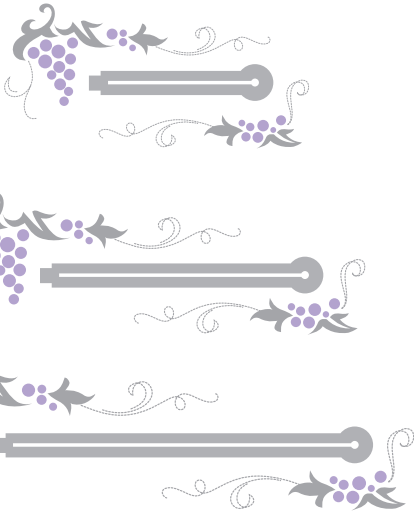

No.11



No.12

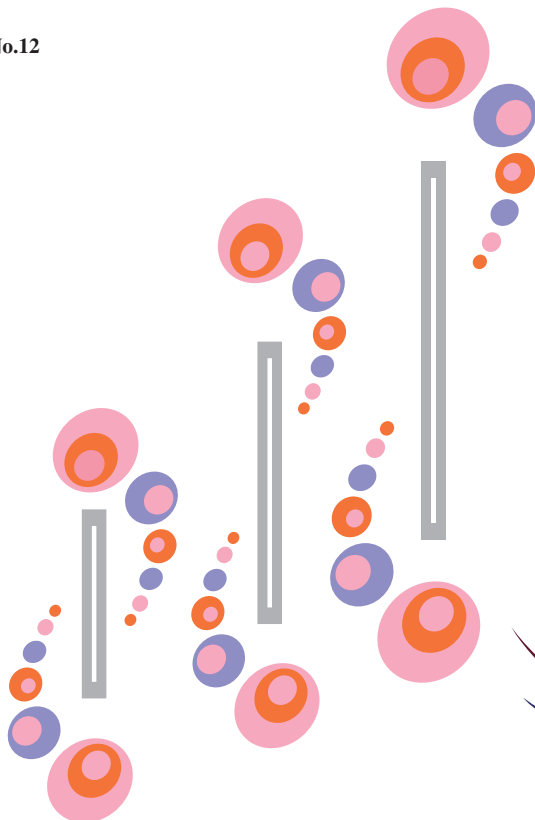

No.14

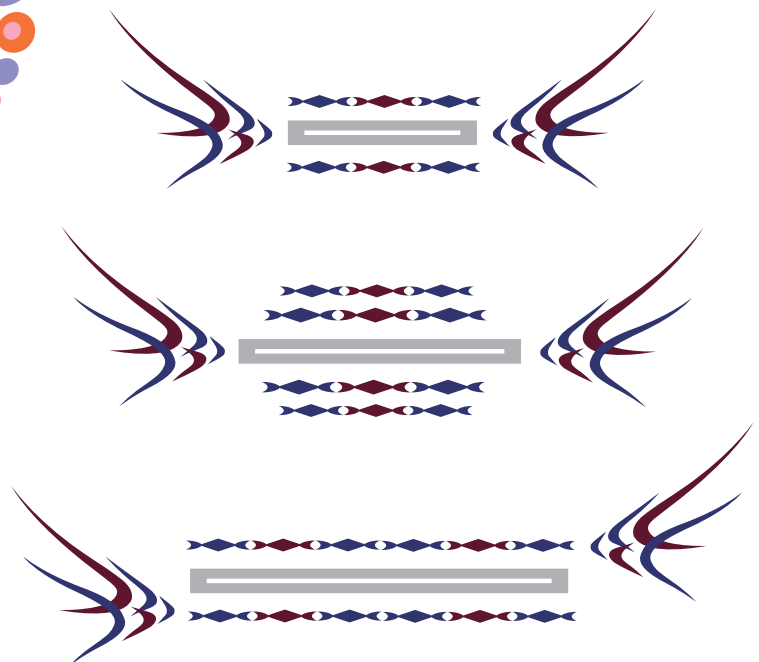

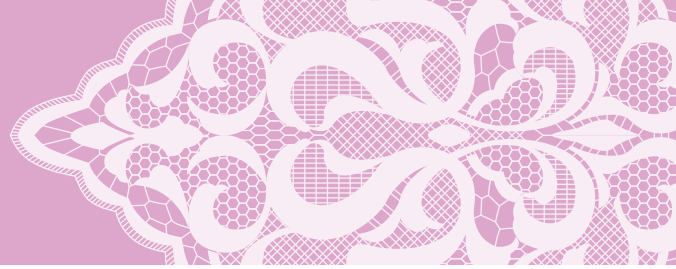

3D combination motifs

Motifs de combinaison 3D

Motivi tridimensionali combinati

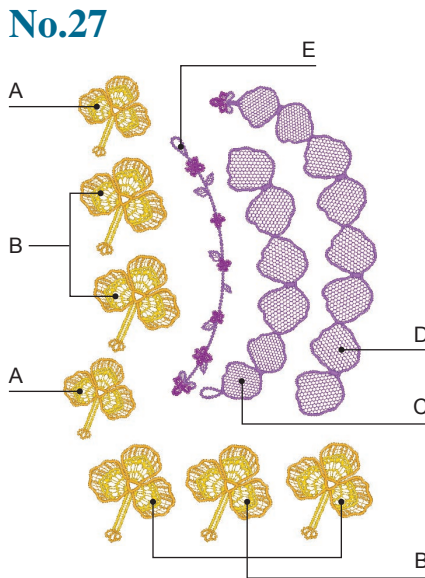

3D-Kombinationsmotive

3D-combinatiemotieven

Motivos de combinación 3D

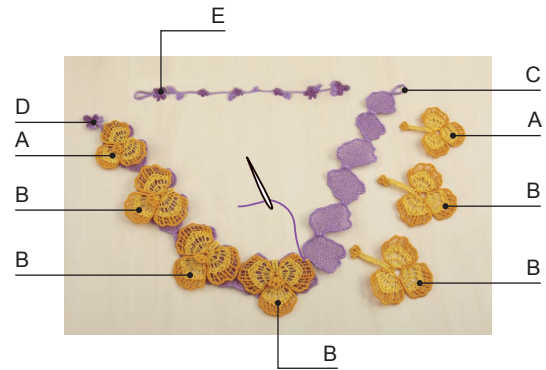
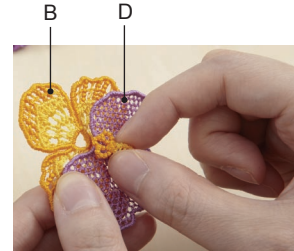

How to make 3D combination motifs

1. Use the same color of thread in the bobbin and on top for the designs.
2. Embroider individual shapes. When sections are completed they are joined to make dimensional shapes. Use a thread or narrow ribbon of a complimentary color to join them.
3. Turn off the "Jump stitch thread cutting function" before embroidering. (Refer to the operation manual for directions on how to do this.)

The following are things you should be aware of when using water-soluble sheets without any fabric. When embroidering these designs, please use three layers of water-soluble sheets. Remember to check that you have enough upper thread and lower thread for the design. If the thread breaks during embroidery, back up at least 10 stitches before starting again. If your embroidery machine has a speed reduction feature, select the lowest speed. When dissolving the water-soluble sheet, cut off the unnecessary portions and wash the embroidered piece in warm water until it no longer feels slippery. After the final rinse, dry the embroidery motif until slightly damp, shape by hand or with a cool iron, allow to dry completely.

Comment réaliser des combinaisons de motifs 3D

1. Utilisez la même couleur de fil dans la bobine et sur le dessus pour les motifs.
2. Brodez les formes séparément. Lorsque les différentes parties sont complétées, elles sont jointes pour créer des formes en volume. Utilisez un fil ou un ruban étroit d'une couleur complémentaire pour les joindre.
3. Désactivez la « Fonction de coupe des sauts de fils » avant la broderie. (Reportez-vous au Manuel d'instructions pour obtenir les instructions correspondantes.)

Voici ci-dessous les points que vous devez considérer lorsque vous utilisez uniquement des feuilles solubles dans l'eau pour la broderie sans aucun tissu. Lorsque vous brodez ces motifs, veuillez utiliser trois couches de feuilles hydrosolubles. Assurez-vous de bien vérifier que vous avez assez de fil supérieur et de fil inférieur pour le motif. Si le fil casse au cours de la broderie, consolidez au moins 10 points avant de recommencer. Si votre machine à broder est équipée d'une fonction de réduction de la vitesse, veuillez choisir la vitesse la plus lente. Lors de la dissolution de la feuille hydrosoluble, coupez les parties inutiles et lavez la pièce brodée à l'eau tiède jusqu'à ce qu'elle ne soit plus glissante. Après le rinçage final, séchez le motif de broderie jusqu'à ce qu'il ne soit plus que légèrement humide, donnez lui sa forme à la main ou avec un fer à repasser froid avant de le laisser sécher complètement.

Come creare motivi tridimensionali combinati

1. Per la parte superiore nei disegni usare lo stesso colore di quello del rocchetto.
2. Ricamare le forme individualmente. Una volta completate le sezioni le si può unire per creare forme dimensionali. Per l'unione si suggerisce di usare un filo o un nastro stretto del colore desiderato.
3. Prima di procedere con il ricamo occorre disattivare la "funzione di taglio saltapunti". (Fare riferimento al manuale d'istruzione per informazioni su come eseguire questa operazione.)

In caso d'uso di pellicole solubili in acqua per ricamo senza tessuto occorre essere consapevoli dei seguenti aspetti: Per ricamare quei disegni si suggerisce di usare tre strati di pellicola solubile in acqua. Ricordare di accertarsi di disporre di filo superiore e inferiore a sufficienza per il disegno. Se durante il ricamo il filo si spezza, prima di riprendere a ricamare tornare indietro almeno dieci punti. Se la propria macchina da cucire dispone della funzione di regolazione della velocità occorre selezionare la più bassa. Durante lo scioglimento della pellicola solubile in acqua occorre rimuovere le parti non necessarie e risciacquare il ricamo in acqua calda sino a quando cessa di essere viscido. Dopo il risciacquo finale il motivo ricamato andrà lasciato asciugare sino a quando rimarrà lievemente umido, quindi gli si darà la forma desiderata a mano o con un ferro da stiro freddo lasciandolo poi asciugare completamente.

Anfertigen von 3D-Kombinationsmotiven

1. Verwenden Sie für die Muster Faden derselben Farbe in der Spule und oben.
2. Sticken Sie die einzelnen Formen. Die fertigen Abschnitte werden zusammengefügt, um plastische Formen zu schaffen. Verwenden Sie zum Zusammenfügen ein Garn oder schmales Band in einer passenden Farbe.
3. Schalten Sie die „Sprungnaht-Abschneidefunktion“ vor dem Sticken aus. (Hinweise dazu, siehe Bedienungsanleitung.)

Die folgenden Punkte sind zu beachten, wenn für eine Stickarbeit nur wasserlösliche Folie ohne Stoff verwendet wird. Verwenden Sie beim Sticken solcher Muster bitte drei Lagen wasserlösliche Folie. Achten Sie darauf, dass ausreichend Ober- und Unterfaden für das Muster vorhanden ist. Sollte der Faden beim Sticken reißen oder ausgehen, gehen Sie zum Weitersticken mindestens 10 Stiche zurück. Falls Ihre Stickmaschine eine Geschwindigkeitsregelung hat, wählen Sie die langsamste Stufe. Zum Auflösen der wasserlöslichen Folie schneiden nicht benötigte Teile ab und waschen die Stickarbeit in warmem Wasser aus, bis sie sich nicht mehr schlüpfrig anfühlt. Nach dem letzten Spülgang lassen Sie das Stickmotiv trocknen, bis es leicht feucht ist, formen es von Hand oder mit einem kalten Bügeleisen aus, und lassen es dann vollständig trocknen.

Hoe maak ik 3D Combinatiemotiefjes

1. Gebruik dezelfde kleur draad in de spoel en aan de bovenkant voor elk ontwerp.
2. Borduur afzonderlijke vormen. Als alle onderdelen klaar zijn worden ze bij elkaar gevoegd om dimensionale vormen te maken. Gebruik draad of lint van een gepaste kleur om de onderdelen samen te voegen.
3. Zet de "Sprongsteek afsnijfunctie" uit voordat U begint met borduren. (Zie de bedieningshandleiding voor aanwijzingen over hoe u te werk moet gaan.)

Als U alleen wateroplosbaar papier gebruikt voor het borduren zonder textiel, dient U de volgende dingen in acht te houden. Indien U die ontwerpen borduurt, gebruik dan drie lagen van het wateroplosbare papier. Vergeet niet van tevoren vast te stellen dat U genoeg bovendraad en onderdraad voor het ontwerp heeft. Mocht de draad breken tijdens het borduren, ga dan minstens 10 steken terug voordat U weer opnieuw begint. Als uw borduurmachine een functie voor snelheidsreductie heeft, kies dan de laagst mogelijke snelheid. Wanneer U het wateroplosbare papier oplost, verwijder de onnodige delen en was het borduurwerk in warm water tot het niet meer glad aanvoelt. Laat na de laatste spoelbeurt het borduurmotief drogen tot het licht vochtig is, vorm het vervolgens met de hand of met een koud strijkijzer, en laat het volledig drogen.

Cómo realizar motivos de combinación 3D

1. Utilice el mismo color de hilo en la bobina y en la parte superior para los diseños.
2. Borda talles individuales. Cuando se finalizan las secciones, se juntan para componer talles dimensionales. Utilice un hilo o una cinta estrecha de color complementario para unirlos.
3. Desactive la función de "Saltar el corte del hilo de coser" antes de bordar. (Consulte en el manual de instrucciones el procedimiento para hacerlo.)

A continuación se indica lo que usted deberá tener en cuenta cuando utilice solamente láminas solubles en agua para bordar sin ninguna tela. Cuando borde tales diseños, utilice tres capas de láminas solubles en agua. No se olvide de comprobar si tiene hilo superior e inferior para el diseño. Si el hilo se rompe durante el bordado, vuelva atrás 10 puntadas por lo menos antes de comenzar de nuevo. Si su máquina de bordar posee función de reducción de velocidad, seleccione la velocidad más baja. Cuando disuelva la lámina soluble en agua, corte las partes innecesarias, y lave la pieza bordada en agua caliente hasta que deje de notarse resbaladiza. Después del lavado final, seque el adorno bordado hasta que esté ligeramente húmedo, déle forma con la mano o con un plancha fría, y deje que se seque completamente.

Color Thread Conversion Chart















































































Tableau de conversion des fils de couleur

Tabella di conversione dei fili colorati













































Stickgarn-Farbtabelle

Omzettingstabel voor kleurgaren

Tabla de conversión de hilos de color

	Color Name / Name der Farbe / Nom de la couleur / Kleur naam / Nome del colore / Nombre de color	Embroidery	Country	Madeira Polyneon	Madeira Rayon	Sulky	R.A. Polyester
1	Black / Schwarz / Noir / Zwart / Nero / Negro	 900	 100	1800	1000	1005	5596
2	White / Weiss / Blanc / Wit / Bianco / Blanco	 001	 000	1801	1002	1001	5597
3	Red / Rot / Rouge / Rood / Rosso / Rojo	 800	 149	1637	1037	1037	5678
4	Pink / Rosa / Rose / Rose / Rosa / Rosado	 085	 155	1921	1108	1224	5523
5	Deep Rose / Tiefrot / Rose foncé / Roserood / Rosa Intenso / Rosa Intenso	 086	 024	1721	1117	1154	9168
6	Flesh Pink / Fleischfarben / Rose chair / Lichtrose / Rosa Carne / Rosa Claro	 124	 152	1915	1015	1064	5677
7	Dark Fuchsia / Dunkelviolett / Fuchsia foncé / Donker Fuchsia Paars / Fuchsia Scuro / Fuscina Oscuro	 107	 126	1984	1383	1533	5804
8	Vermillion / Zinnoberrot / Vermillon / Vermil Joen / Rosso Vermiglio / Bermellon	 030	 148	1779	1179	1184	9023
9	Carmine / Karminrot / Carmin / Karmijn / Rosso Carminio / Carmin	 807	 158	1986	1081	1511	5561
10	Royal Purple / Königspurpur / Pourpre royal / Dieppaars / Rosso-Violaceo / Violeta Real	 869	 636	1788	1188	1192	5681
11	Magenta / Magenta / Magenta / Magenta / Magenta / Magenta	 620	 625	1710	1319	1191	5592
12	Salmon Pink / Lachsrosa / Rose saumon / Zalmrose / Rosa Salmone / Rosa Salmon	 079	 122	1816	1317	1225	5773
13	Amber Red / Bernsteinrot / Rouge ambre / Amber Rood / Rosso Ambra / Rojo Ambar	 333	 212	1942	1341	1119	5591
14	Lemon Yellow / Zitronengelb / Jaune citron / Citroengeel / Giallo Limone / Amarillo Limon	 202	 342	1623	1023	1067	5625
15	Yellow / Gelb / Jaune / Geel / Giallo / Amarillo	 205	 043	1980	1068	1187	5860
16	Harvest Gold / Erntegold / Or blé / Oogst Kleurig Goud / Giallo Grano / Amarillo Trigo	 206	 334	1971	1024	1124	5770
17	Orange / Orange / Orange / Oranje / Arancio / Naranja	 208	 335	1951	1137	1024	5694
18	Pumpkin / Kürbisgelb / Citrouille / Pompoen / Giallo Zucca / Calabaza	 126	 322	1952	1155	1065	5630
19	Tangerine / Mandarinenorange / Tangerine / Felorange / Mandarino / Tangerina	 209	 336	1965	1078	1078	5518
20	Cream Brown / Braun Weiss / Brun crème / Creme Bruin / Nocciola / Marron Crema	 010	 331	1866	1022	1061	5761
21	Cream Yellow / Gelblich Weiss / Jaune crème / Cremegeel / Giallo Crema / Amarillo Crema	 812	 370	1861	1349	1135	5564
22	Khaki / Khakibraun / Kaki / Khaki / Kaki / Caqui	 348	 242	1939	1255	1055	5636
23	Deep Gold / Tiefgold / Or foncé / Diepgoud / Oro Scuro / Amarillo Oro	 214	 354	1772	1172	1025	5770
24	Brass / Messingfarben / Cuiivre / Koper / Ottone / Bronce	 328	 404	1791	1192	1159	9109
25	Linen / Leinen Farbig / Drap / Linnen / Lino / Lino	 307	 025	1682	1149	1082	5635
26	Dark Brown / Dunkelbraun / Brun sombre / Donker Bruin / Marrone Scuro / Marron Oscuro	 058	 717	1859	1130	1129	5637
27	Reddish Brown / Rotbraun / Brun rougeâtre / Rassing Bruin / Marrone Bruciato / Marron Rojizo	 337	 264	1753	1253	1021	5781
28	Clay Brown / Lehmtraun / Brun argile / Kleibruin / Marrone Argilla / Marron Tierra	 339	 224	1621	1021	1158	5590
29	Beige / Beige / Beige / Beige / Beige / Beige	 843	 012	1738	1138	1127	5598
30	Warm Gray / Warmgrau / Gris vif / Warm Grijs / Grigio Caldo / Gris Caliente	 399	 706	1860	1085	1218	9126
31	Russet Brown / Rotbraun / Brun roussâtre / Roodbruin / Ruggine / Marron Bermejo	 330	 414	1726	1194	1126	5702
32	Light Brown / Hellbraun / Brun clair / Licht Bruin / Marrone Chiaro / Marron Claro	 323	 255	1729	1056	1128	5789
33	Seacrest / Blassgrün / Vert pale / Blauw Groen / Cresta Di Mare / Verde Celadon	 542	 505	1647	1219	1077	5578
34	Mint Green / Pfefferminzgrün / Vert menthe / Munt Groen / Verde Menta / Verde Menta	 502	 461	1702	1302	1047	5511
35	Leaf Green / Blattgrün / Vert feuille / Bladgroen / Verde Prato / Verde De Hoja	 509	 463	1749	1050	1510	5514
36	Olive Green / Olivgrün / Vert olive / Olijf Groen / Verde Oliva / Verde Oliva	 519	 476	1904	1396	1174	5502
37	Dark Olive / Dunkelolivgrün / Olive foncé / Donker Olijf / Oliva Scuro / Verde Oliva Oscuro	 517	 473	1769	1156	1156	9122
38	Teal Green / Blaugrün / Vert sarcelle / Taling Groen / Verde Anatra / Verde Azulado	 534	 483	1879	1298	1503	5751
39	Emerald Green / Emerald Grün / Vert émeraude / Smaragd Groen / Verde Smeraldo / Verde Esmeralda	 507	 485	1750	1250	1079	5508

Color Thread Conversion Chart
Stickgarn-Farbtabelle
Tableau de conversion des fils de couleur
Omzettingstabel voor kleurgaren
Tabella di conversione dei fili colorati
Tabla de conversión de hilos de color

	Color Name / Name der Farbe / Nom de la couleur / Kleur naam / Nome del colore / Nombre de color	Embroidery	Country	Madeira Polyneon	Madeira Rayon	Sulky	R.A. Polyester
40	Deep Green / Dunkelgrün / Vert foncé / Diepgroen / Verde Intenso / Verde Intenso	 808	 467	1703	1370	1208	5615
41	Fresh Green / Frischgrün / Vert frais / Licht Groen / Verde Mela / Verde Fresco	 027	 442	1706	1102	1209	9153
42	Lime Green / Limonengrün / Vert tilleul / Limoen Groen / Verde Tiglio / Verde Lima	 513	 444	1848	1049	1177	5622
43	Moss Green / Moosgrün / Vert mousse / Mosgroen / Verde Muschio / Verde Musgo	 515	 446	1770	1369	1176	9091
44	Blue / Blau / Bleu / Blauw / Azzurro / Azul	 405	 586	1829	1177	1076	5684
45	Ultra Marine / Ultra Marin / Outremer / Ultra Marijn / Blu Oltremare / Azul De Ultramar	 406	 575	1842	1076	1042	5736
46	Light Blue / Hellblau / Bleu clair / Licht Blauw / Celeste / Azul Claro	 017	 150	1932	1132	1074	5683
47	Sky Blue / Himmelblau / Bleu ciel / Hemels Blauw / Azzurro Cielo / Celeste	 019	 512	1828	1029	1196	5506
48	Electric Blue / Elektrischblau / Bleu électrique / Staal Blauw / Blu Elettrico / Azul Electrico	 420	 564	1797	1297	1250	5829
49	Peacock Blue / Pfauenblau / Bleu paon / Pauwen Blauw / Blu Pavone / Azul Pavo Real	 415	 057	1652	1252	1206	5810
50	Prussian Blue / Berliner Blau / Bleu de Prusse / Pruisisch Blauw / Blu De Prussia / Azul De Prusia	 007	 588	1767	1166	1535	5737
51	Cornflower Blue / Kornblumenblau / Bleu centauree / Koren Bloemen Blauw / Blu Fior-Daliso / Azul Centaura	 070	 015	1830	1335	1028	5601
52	Light Lilac / Helllila / Lilas clair / Licht Lila / Lilla Chiaro / Lila Suave	 810	 133	1911	1031	1121	9016
53	Lilac / Lila / Lilas / Lila / Lilla / Lila	 612	 623	1831	1080	1080	9009
54	Violet / Violet / Violet / Violet / Violetto / Violeta	 613	 624	1631	1033	1194	5588
55	Purple / Purpur / Pourpre / Paars / Viola / Purpura	 614	 635	1880	1122	1122	5554
56	Lavender / Lavendel / Lavande / Lavendel / Lavenda / Lavanda	 804	 604	1630	1261	1193	5586
57	Wisteria Violet / Wistaria Violet / Violet glycine / Blauwe Regen Paars / Glicine / Violeta Vistaria	 607	 003	1943	1311	1032	5587
58	Pewter / Zinngrau / Étain / Tinkleurig / Peltro / Peltre	 704	 745	1840	1041	1041	9114
59	Dark Gray / Dunkelgrau / Gris sombre / Donker Grijs / Grigio Scuro / Gris Oscuro	 707	 747	1841	1241	1220	5565
60	Silver / Silber / Argent / Silver / Argento / Plata	 005	 020	1812	1087	1011	5640
61	Gray / Grau / Gris / Grijs / Grigio / Gris	 817	 734	1640	1118	1219	5782
62	----->						
63	-----						
64	~~~~~ TTTTTTTTTTTTTTTTTTTT						
65	NOT DEFINED / NICHT DEFINIERT / NON DEFINI / NIET GEDEFINEERD / NON DEFINITO / SIN DEFINIR						

Note: The conversion chart is based on Embroidery thread. The color shades may vary with the different brands listed on the chart. If unsure of a particular color(s), please sew test. Robison Anton (R.A.), Madeira and Sulky are respectively registered trademarks. Actual colors may vary slightly from the chart.

Hinweis: Die Umrechnungstabelle basiert auf dem Stickgarn. Die Farbschattierungen können je nach unterschiedlichen, in der Tabelle aufgeführten Marken abweichen. Wenn Sie sich bei bestimmten Farben nicht sicher sind, nähern Sie bitte zur Probe. Robison Anton (R.A.), Madeira und Sulky sind eingetragene Warenzeichen. Die tatsächlichen Farben können leicht von der Tabelle abweichen.

Remarque: Le tableau de conversion est basé sur le fil de broderie. Les nuances de couleur peuvent varier en fonction des marques énumérées dans le tableau. En cas de doute sur un coloris, faites un essai de couture. « Robison Anton (R.A.) », « Madeira » et « Sulky » sont des marques déposées respectives. Les couleurs réelles risquent d'être légèrement différentes de celles du tableau.

Opmerking: Het omzettingsschema is gebaseerd op het gebruik van borduurzijde. De kleurtinten kunnen ietwat verschillen voor de diverse merken in het schema. Bent u niet zeker bent van de juiste kleur(en), borduur dan een stukje op proef. De namen Robison Anton (R.A.), Madeira en Sulky zijn allemaal gedeponeerde handelsmerken. De feitelijke kleurtinten kunnen iets afwijken van het getoonde schema.

Nota: La tabella di conversione è in funzione del filo da ricamo. Le tonalità cromatiche possono variare secondo le differenti marche elencate nella tabella. In caso di dubbio su un particolare colore o su più colori si raccomanda di eseguire una prova di cucito. Robison Anton (R.A.), Madeira e Sulky sono marchi di fabbrica registrati. I colori effettivi possono variare lievemente rispetto a quelli della tabella.

Nota: La tabla de conversión está basada en hilo de bordar. Los tonos de color podrán variar con las diferentes marcas enumeradas en la tabla. Si tiene dudas sobre un color o colores en particular, haga un cosido de prueba. Robison Anton (R.A.), Madeira y Sulky son marcas registradas respectivamente. Los colores verdaderos podrán variar ligeramente con respecto a los de la tabla.

English
German
French
Dutch
Italian
Spanish

882-W07
Printed in Taiwan



XF6299-001