

Quick reference guide
Kurzanleitung
Guide de référence rapide
Beknopte bedieningsgids
Guida di riferimento rapido
Guía de referencia rápida
Hurtigguide
Краткий справочник

Refer to the operation manual for detailed instruction.

Also, there are differences in the keys and screens depending on the display language. In this guide, English screens are used for basic explanations.

Einzelheiten entnehmen Sie bitte der Bedienungsanleitung.

Je nachdem, welche Sprache für die Bildschirmanzeigen gewählt wurde, ergeben sich im Hinblick auf Bildschirmbilder eventuell Unterschiede. Die grundlegende Bedienung der Maschine ist in dieser Anleitung am Beispiel von Bildschirmbildern mit englischem Text erklärt.

Pour les instructions détaillées, voir le mode d'emploi.

Par ailleurs, il y a des différences dans les touches et les écrans en fonction de la langue d'affichage. Dans ce guide, les explications de base utilisent les écrans anglais.

Zie de gebruiksaanwijzing voor gedetailleerde instructies.

Er zijn verschillen in de toetsen en schermen afhankelijk van de ingestelde taal. In de beschrijvingen in deze beknopte handleiding worden de Engelse schermen gebruikt.

Fare riferimento al manuale d'istruzioni per le istruzioni dettagliate.

Inoltre, ci sono differenze nei tasti e nelle schermate a seconda della lingua visualizzata. In questa guida, le schermate in inglese sono usate per le spiegazioni basilari.

Consulte el manual de instrucciones para ver más detalles.

Además, dependiendo del idioma visualizado algunos botones y pantallas podrán ser diferentes. En esta guía, para las explicaciones básicas se emplean pantallas en inglés.

Vennligst les den engelske instruksjonsboken for mer detaljerte instruksjoner.

I denne guiden er de engelske skjermbildene brukt i forklaringene. Merk at skjermbilder og taster kan se annerledes ut, avhengig av hvilket språk som er valgt i displayet.

Более подробная информация представлена в руководстве по эксплуатации.

Кроме того, в зависимости от языка сообщений на ЖК-дисплее названия кнопок и другая информация на экранах могут иметь некоторые различия. В настоящем справочнике основные пояснения даются на примере экранов с информацией на английском языке.

<English display>
<Englische Anzeige>
<Affichage en anglais>
<Engels scherm>
<Schermata in inglese>
<Visualización en inglés>
<Engelsk: utfoldelse>
<Экран: английский язык>

<Example: German>
<Beispiel: Deutsch>
<Exemple : allemand>
<Voorbeeld: Duits>
<Esempio: Tedesco>
<Ejemplo: Alemán>
<Eksempel: Tysk>
<Пример: немецкий язык>

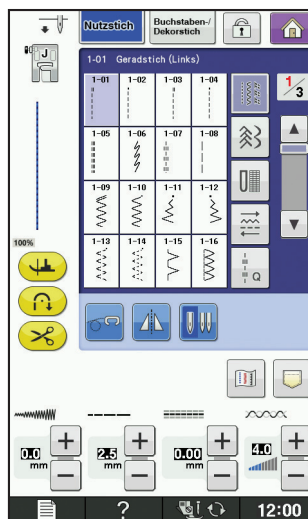
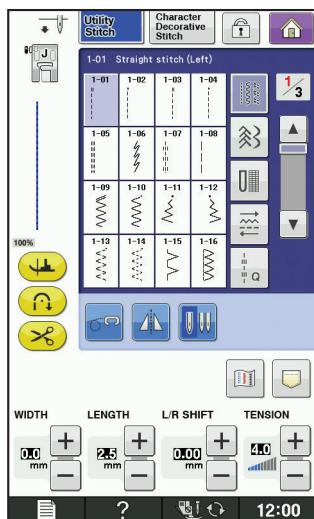

Copyright, Zündt Design 2012, All rights reserved.

All artwork and designs created by Zündt Design Ltd are copyrighted. The embroidery data you obtain from zundtdesign.com and Zündt Design Ltd is licensed for customer use only.

Copyright, Zündt Design 2012, Tous droits réservés.

Tous les travaux et motifs créés par Zündt Design Ltd sont protégés par le droit d'auteur. Les motifs de broderie obtenus de zundtdesign.com et de Zündt Design Ltd ne peuvent être utilisés qu'à titre privé.

Copyright, Zündt Design 2012, tutti i diritti riservati.

Tutte le illustrazioni e i disegni creati da Zündt Design Ltd sono protetti da copyright. I disegni da ricamo ottenuti da zundtdesign.com e Zündt Design Ltd sono concessi in licenza esclusivamente per l'uso da parte dei clienti.

Opphavsrett, Zündt Design 2012, Med enerett.

Alle originaler og design utviklet av Zündt Design Ltd er opphavsrettslig beskyttet. Broderimønstrene du henter fra zundtdesign.com og Zündt Design Ltd, er kun lisensiert for bruk av kunder.

Copyright, Zündt Design 2012, Alle Rechte vorbehalten.

Alle von Zündt Design Ltd erstellte Vorlagen und Designs sind urheberrechtlich geschützt. Die über zundtdesign.com und bei Zündt Design Ltd erhältlichen Stickmuster sind nur für den privaten Gebrauch lizenziert.

Copyright, Zündt Design 2012, Alle rechten voorbehouden.

Alle tekeningen en ontwerpen die zijn gemaakt door Zündt Design Ltd vallen onder copyright. Borduurpatronen die u verkrijgt op zundtdesign.com en Zündt Design Ltd mogen uitsluitend door u als klant worden gebruikt.

Copyright, Zündt Design 2012, Todos los derechos reservados.

Todas las ilustraciones y diseños han sido creados por Zündt Design Ltd, que posee los derechos de autor. Los patrones de bordado disponibles en zundtdesign.com o en Zündt Design Ltd sólo están autorizados para su uso por parte del cliente.

© Zündt Design, 2012. Все права защищены.

Все декоративные элементы и композиции, созданные компанией Zündt Design Ltd., защищены авторским правом. Рисунки вышивания, полученные вами с веб-сайта zundtdesign.com или от компании Zündt Design Ltd., лицензированы только для личного использования.

Contents

Winding the Bobbin	2
Setting the Bobbin	4
Upper Threading	5
Preparing to Embroider	6
Selecting Stitch Patterns	8
Summary of Stitch Patterns	14
Embroidery Pattern Color Change Table	33
Examples of Combinations	60
Color Thread Conversion Chart	65

Table des matières

Bobinage de la canette	2
Mise en place de la canette	4
Enfilage supérieur	5
Préparation de la broderie	6
Sélection des configurations de point	8
Sommaire des motifs de point	14
Tableau de changement de couleur des motifs de broderie	33
Exemples de combinaisons	60
Tableau de conversion des fils de couleur	65

Sommario

Avvolgimento della spolina	2
Impostazione della spolina	4
Infilatura superiore	5
Preparativi per il ricamo	6
Selezione degli schemi punto	8
Sommario degli schemi punto	14
Tabella di cambiamento colori degli schemi di ricamo	33
Esempi di combinazioni	60
Tabella di conversione dei fili colorati	65

Innhold

Spoling av undertråd	2
Sett i spolen	4
Treing av overtråden	5
Forberedelser til brodering	6
Velg søm	8
Oppsummering sømmer	14
Fargeoppsett broderimønstre	33
Eksempler på kombinasjoner	60
Fargekart, konvertert til andre leverandører sine fargenummer	65

Inhalt

Aufspulen des Unterfadens	2
Einsetzen der Spule	4
Einfädeln des Oberfadens	5
Vorbereitung zum Sticken	6
Wahl des Nähmusters	8
Nähmuster-Übersicht	14
Stickmuster-Farbtabelle	33
Kombinationsbeispiele	60
Stickgarn-Farbtabelle	65

Inhoudsopgave

Spoel opwinden	2
Aanbrengen van het spoeltje	4
Inrijgen van de bovendraad	5
Vorbereidingen voor borduren	6
Kiezen van de steekpatronen	8
Overzicht van de steekpatronen	14
Kleurwijzigingstabel voor de borduurpatronen	33
Voorbeelden van combinaties	60
Omzettingstabel voor kleurgaren	65

Contenido

Devanado de la bobina	2
Colocación de la bobina	4
Hilo superior	5
Preparativos para bordar	6
Selección de tipos de puntada	8
Resumen de tipos de puntada	14
Tabla de cambio de color para patrones de bordado	33
Ejemplos de combinaciones	60
Tabla de conversión de hilos de color	65

Содержание

Намотка шпульки	2
Установка шпульки	4
Заправка верхней нити	5
Подготовка к вышиванию	6
Выбор строчки	8
Виды строчек	14
Таблицы цветов нитей для вышивок	33
Примеры комбинирования	60
Таблица преобразования цветов нитей	65

Winding the Bobbin

Bobinage de la canette

Avvolgimento della spolina

Spoling av undertråd

Aufspulen des Unterfadens

Spoel opwinden

Devanado de la bobina

Намотка шпульки

Follow the numbered steps below in order. Refer to the operation manual for detailed instruction.

Führen Sie die folgenden Schritte in der angegebenen Reihenfolge aus. Ausführliche Hinweise finden Sie in der Bedienungsanleitung.

Suivez les étapes numérotées ci-dessous dans l'ordre. Consultez le manuel d'instructions pour des procédures détaillées.

Voer de genummerde stappen uit in de juiste volgorde. Uitvoerige aanwijzingen vindt u in de bedieningshandleiding.

Seguire i passaggi numerati nell'ordine riportato di seguito. Fare riferimento al manuale d'istruzioni per le istruzioni dettagliate.

Realice los siguientes pasos numerados en el orden indicado. Para obtener instrucciones detalladas, consulte el manual de instrucciones.

Ved spoling, følge nummereringen under. Se i instruksjonsboken for en mer detaljert beskrivelse.

Выполните приведенные ниже операции в порядке их нумерации. Более подробная информация представлена в руководстве по эксплуатации.

Use only the enclosed bobbin or bobbins of the same type.

Verwenden Sie nur die im Lieferumfang enthaltene Spule oder Spulen vom selben Typ.

N'utilisez que la canette fournie ou des canettes du même type.

Gebruik alleen de bijgeleverde spoel of spoelen van hetzelfde type.

Utilizzare solo la spolina inclusa o spoline dello stesso tipo.

Utilice sólo la bobina incluida o bobinas del mismo tipo.

Bruk den bakre spolepinnen.

Применяйте только прилагаемые к машине шпульки или шпульки того же типа.

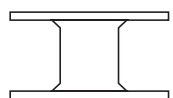

11.5 mm (approx. 7/16 inch)

(ca. 7/16 Zoll)

(env. 7/16 po)

11,5 mm (ca. 7/16 inch)

(circa 7/16 in.)

(aprox. 7/16 pulg.)

(ca. 7/16 tomme)

(прим. 7/16 дюйма)

◆ Using the Supplemental Spool Pin

You can wind the bobbin during sewing.

◆ Utilisation du porte-bobine supplémentaire

Vous pouvez bobiner la canette pendant la couture.

◆ Utilizzo del portarocchetto supplementare

È possibile avvolgere la spolina durante la cucitura.

◆ Bruk vedlagte spolepinne.

Du kan spole mens du syr.

◆ Verwendung des zusätzlichen Garnrollenstifts

Sie können den Unterfaden während des Nähens aufspulen.

◆ Gebruik van de klossen

U kunt de spoel opwinden tijdens het naaien.

◆ Uso del portacarrete suplementario

Puede devanar la bobina mientras está cosiendo.

◆ Использование дополнительного стержня для катушки

Можно наматывать нить на шпульку во время шитья.

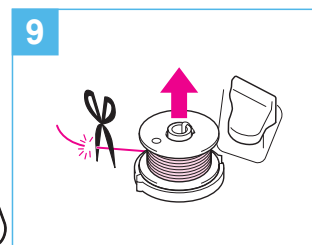
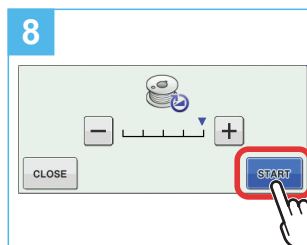
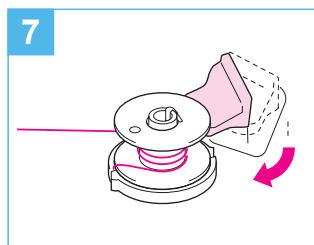
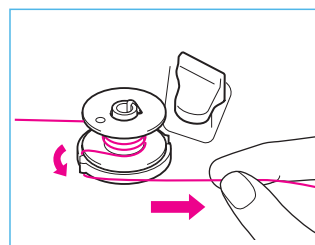
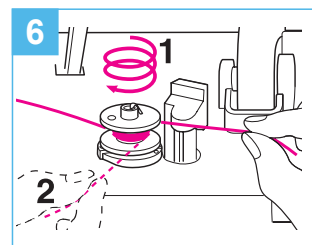
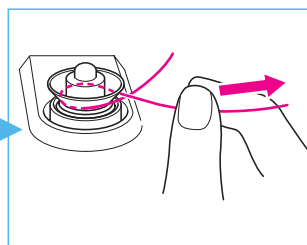
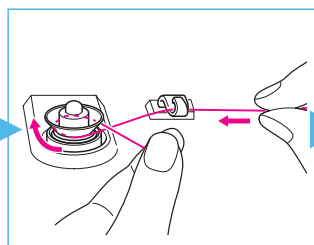
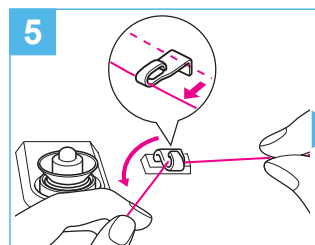
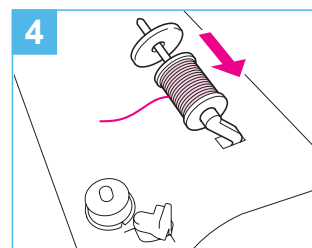
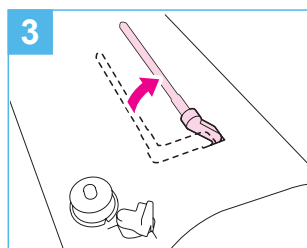
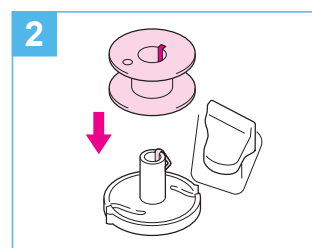
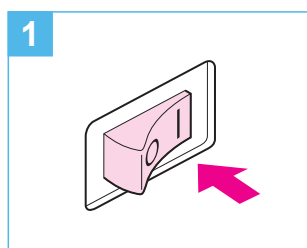
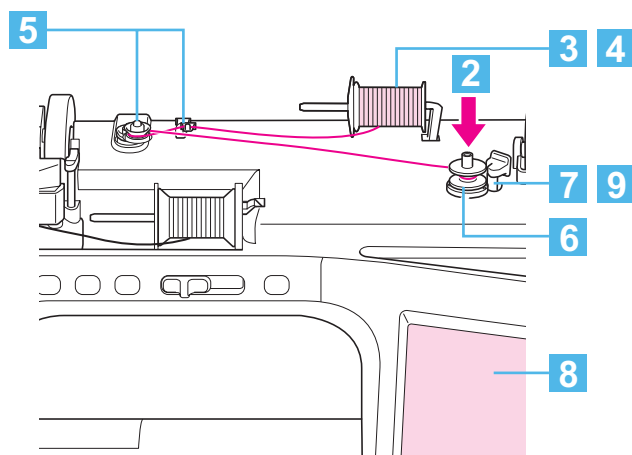

◆ Using the Spool Pin

You can use the main spool pin to wind the bobbin before sewing.

◆ Utilisation du porte-bobine

Vous pouvez bobiner la canette avant de coudre à l'aide du porte-bobine principal.

◆ Utilizzo del portarocchetto

È possibile utilizzare il portarocchetto principale per avvolgere la spolina prima di cucire.

◆ Slik brukes spolepinnen

Du kan bruke hovedspolepinnen til å vikle spolen før du setter i gang med å sy.

◆ Verwendung des Garnrollenstifts

Mit dem Hauptgarnrollenstift können Sie vor dem Nähen den Unterfaden aufspulen.

◆ Gebruik van de klospen

Voordat u gaat naaien kunt u met de hoofdklospen de spool opwinden.

◆ Uso del portacarrete

Puede utilizar el portacarrete principal para devanar la bobina antes de coser.

◆ Использование основного стержня для катушки

Для намотки шпульки перед шитьем можно использовать главный стержень для катушки.

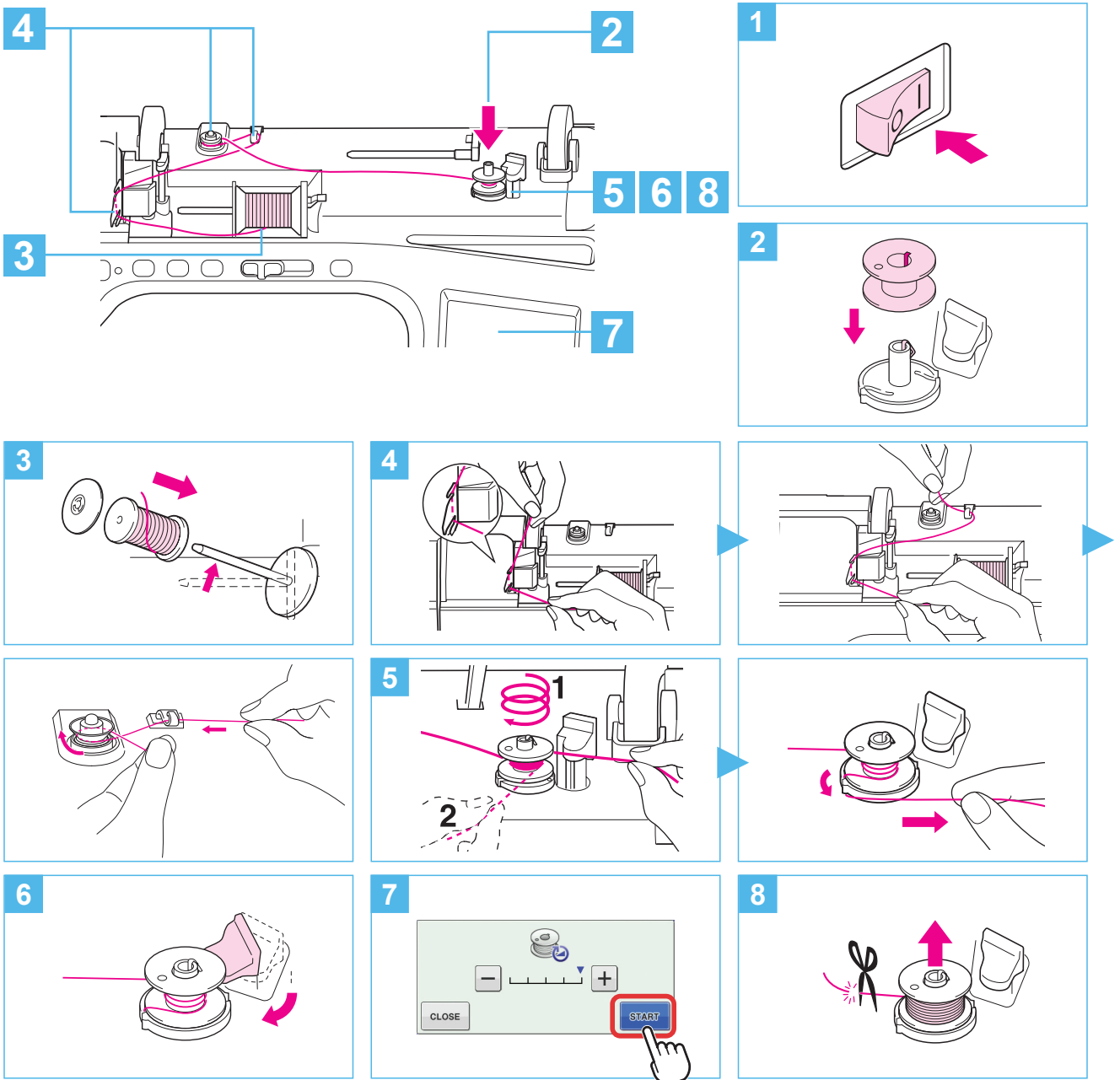

Setting the Bobbin

Mise en place de la canette

Impostazione della spolina

Sett i spolen

Einsetzen der Spule

Aanbrengen van het spoeltje

Colocación de la bobina

Установка шпульки

Refer to the operation manual for detailed instruction.
Pour les instructions détaillées, voir le mode d'emploi.
Fare riferimento al manuale d'istruzioni per le istruzioni dettagliate.
Se i instruksjonsboken for en mer detaljert beskrivelse.

Einzelheiten hierzu entnehmen Sie bitte der Bedienungsanleitung.
Zie de gebruiksaanwijzing voor gedetailleerde instructies.
Consulte el manual de instrucciones para ver más detalles.
Подробная информация: см. в руководстве по эксплуатации

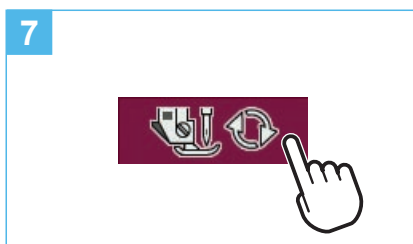
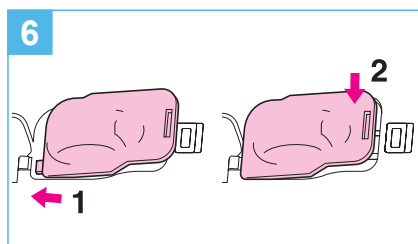
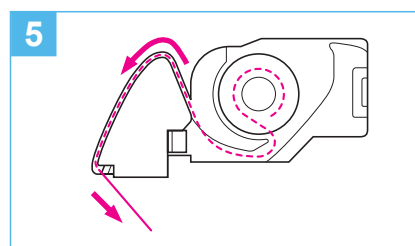
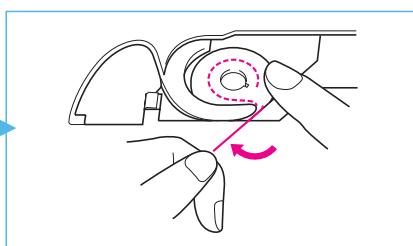
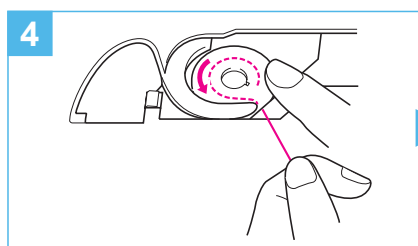
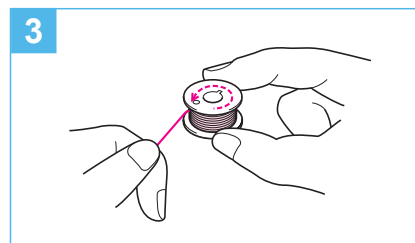
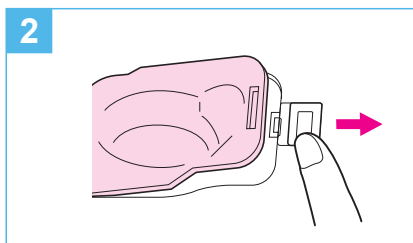
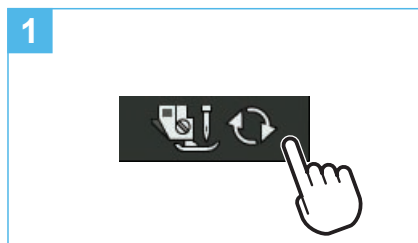

Upper Threading
Enfilage supérieur
Infilatura superiore
Treing av overtråden

Einfädeln des Oberfadens
Inrijgen van de bovendraad
Hilo superior
Заправка верхней нити

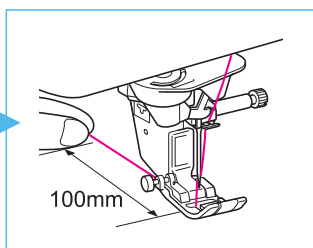
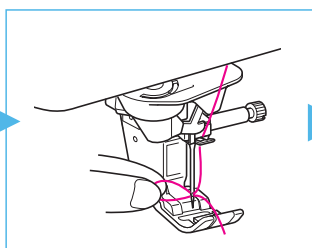
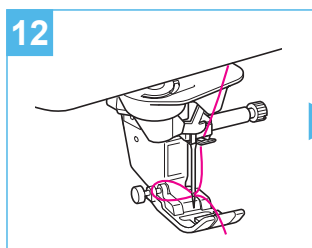
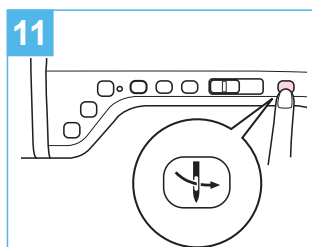
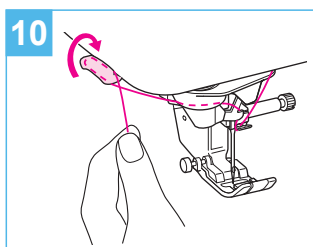
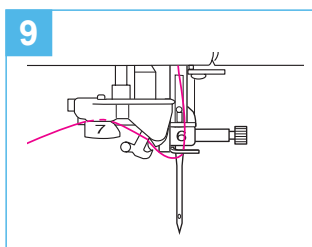
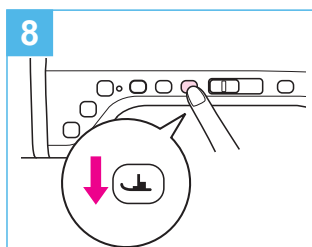
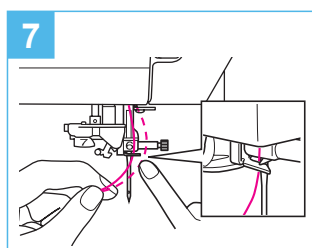
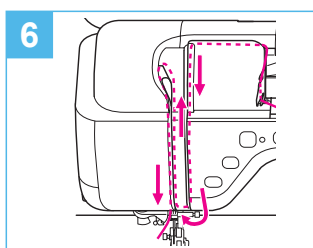
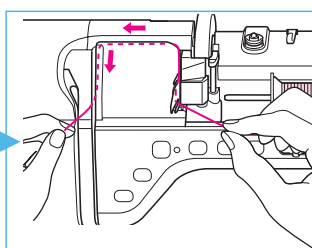
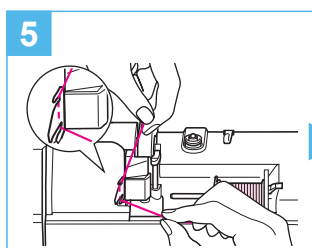
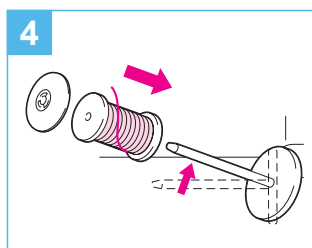
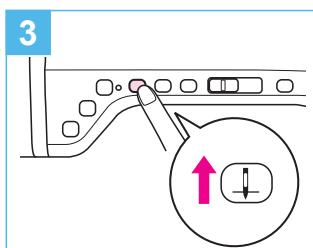
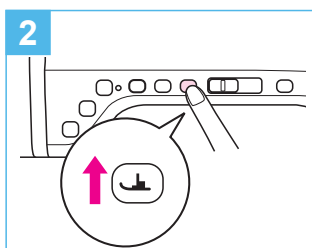
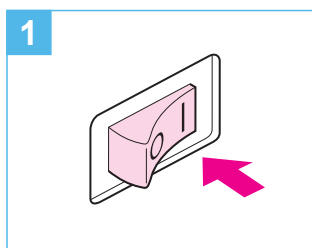
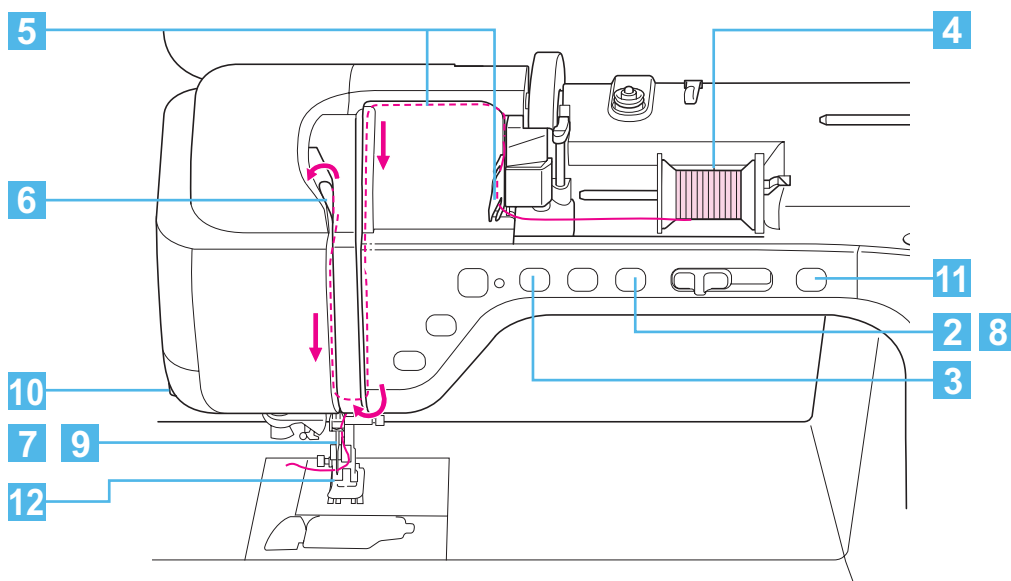

Preparing to Embroider
Préparation de la broderie
Preparativi per il ricamo
Forberedelser til brodering

Vorbereitung zum Sticken
Vorbereidingen voor borduren
Preparativos para bordar
Подготовка к вышиванию

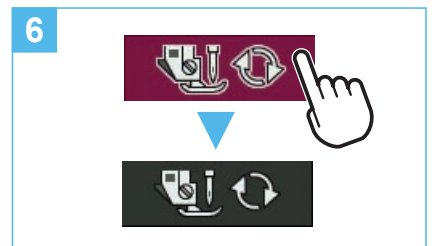
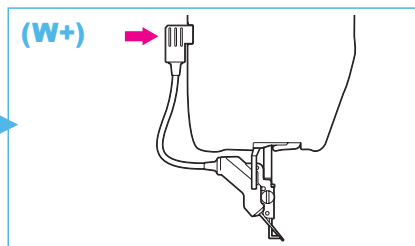
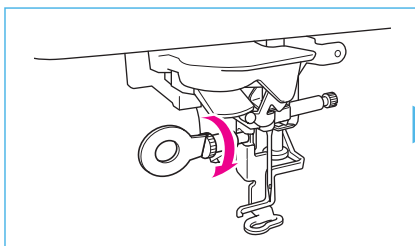
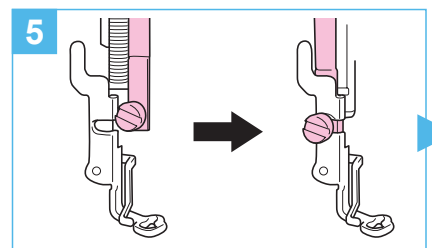
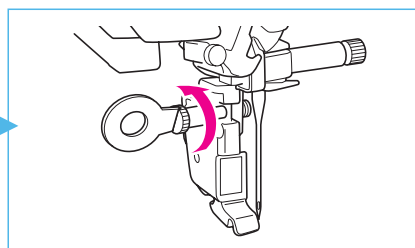
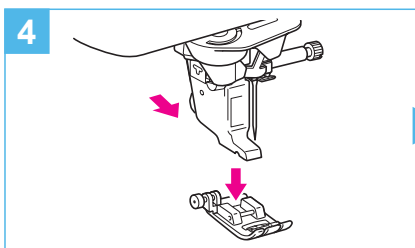
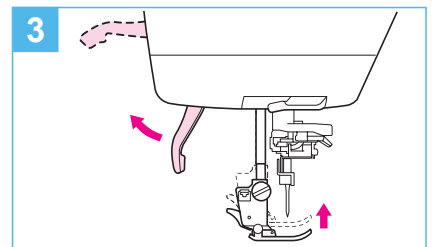
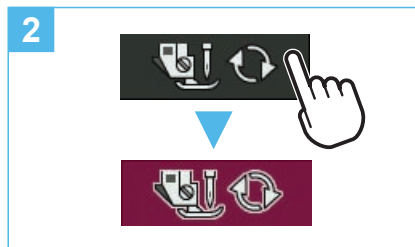
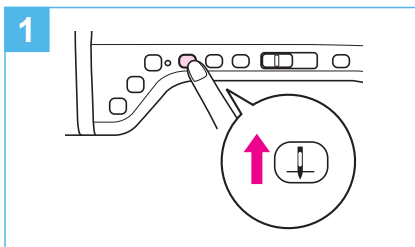
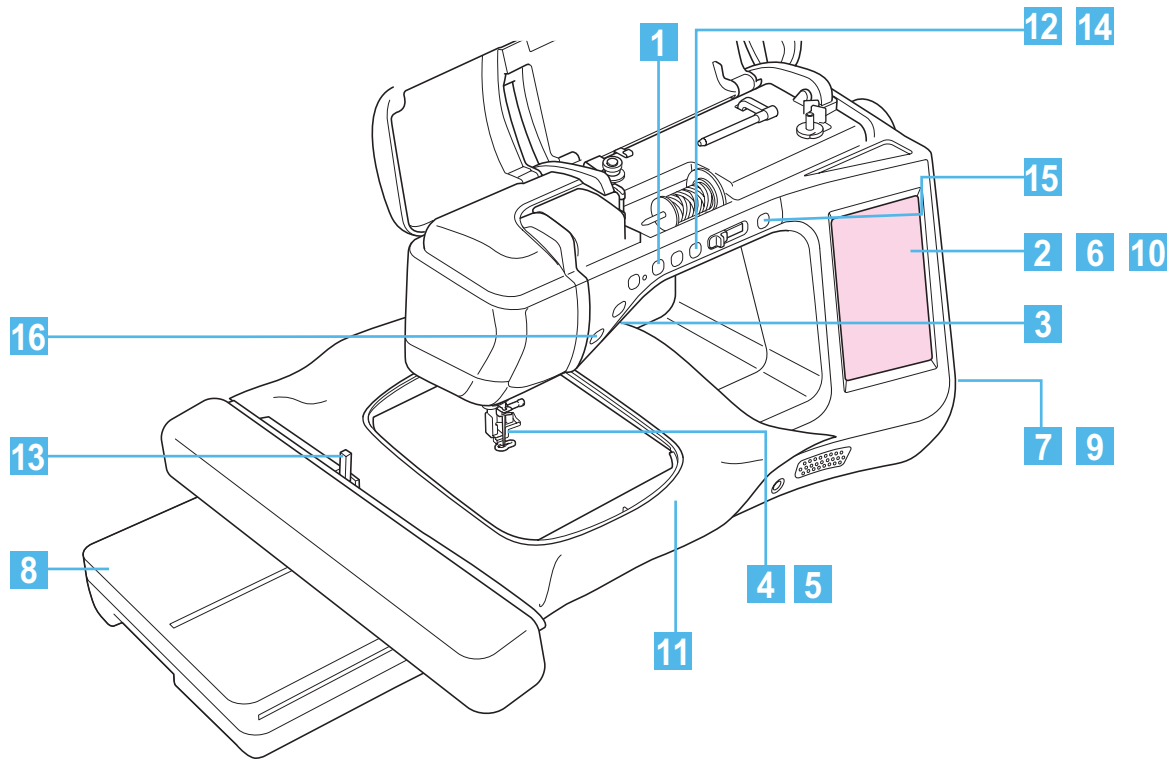

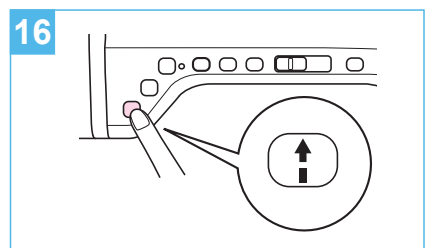
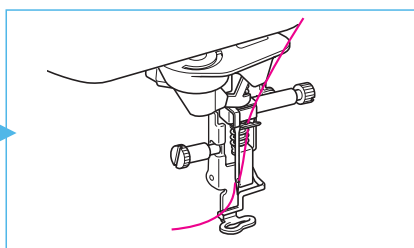
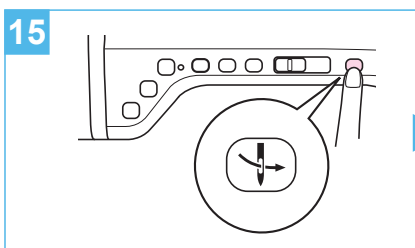
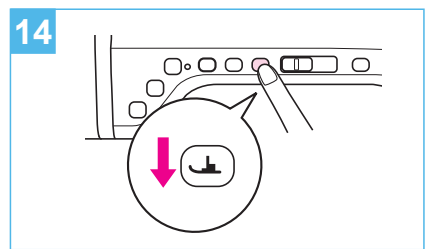
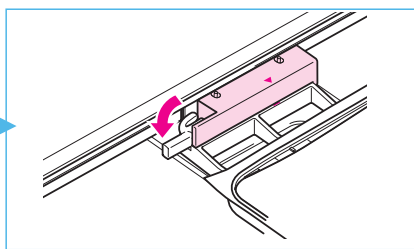
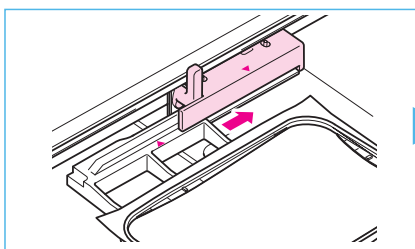
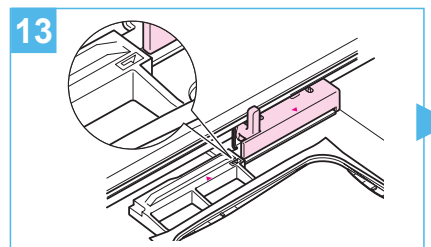
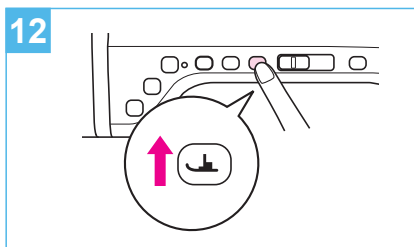
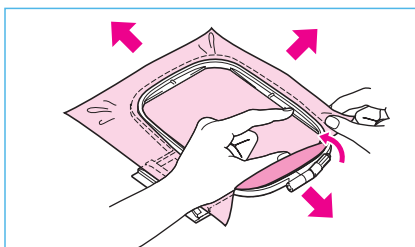
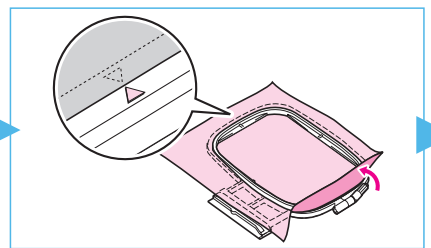
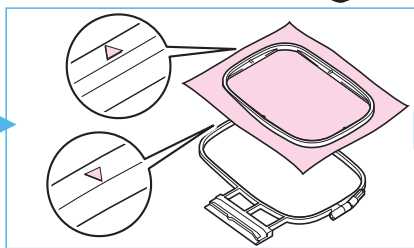
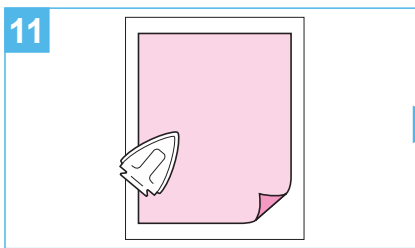
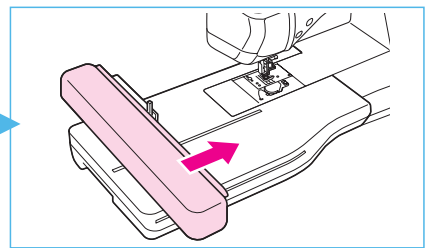
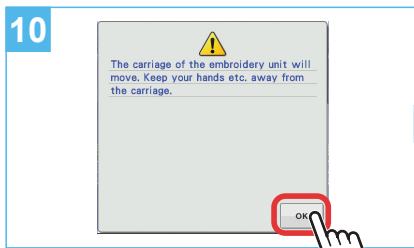
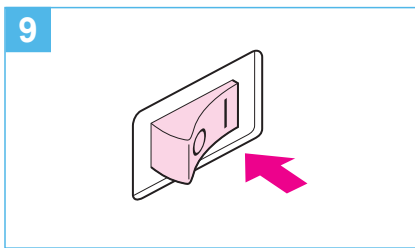
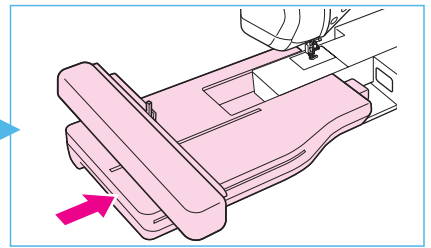
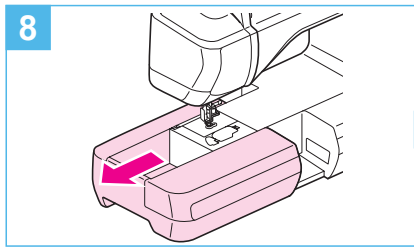
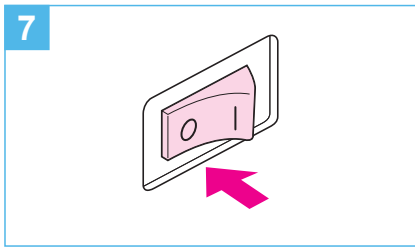

Selecting Stitch Patterns

Sélection des configurations de point
 Selezione degli schemi punto
 Velg søm

Wahl des Nähmusters

Kiezen van de steekpatronen
 Selección de tipos de puntada
 Выбор строчки

The screen display may vary slightly, depending on the countries or regions.
 L'écran peut varier légèrement en fonction des pays ou régions.

- ◆ LCD Flow Chart
- ◆ Organigramme de l'écran à cristaux liquides
- ◆ Schema di flusso LCD
- ◆ LCD-flytdiagram
- ◆ LCD-Übersichtsdiagramm
- ◆ LCD-stroomschema
- ◆ Diagrama de flujo del LCD
- ◆ Схема действий на LCD дисплее

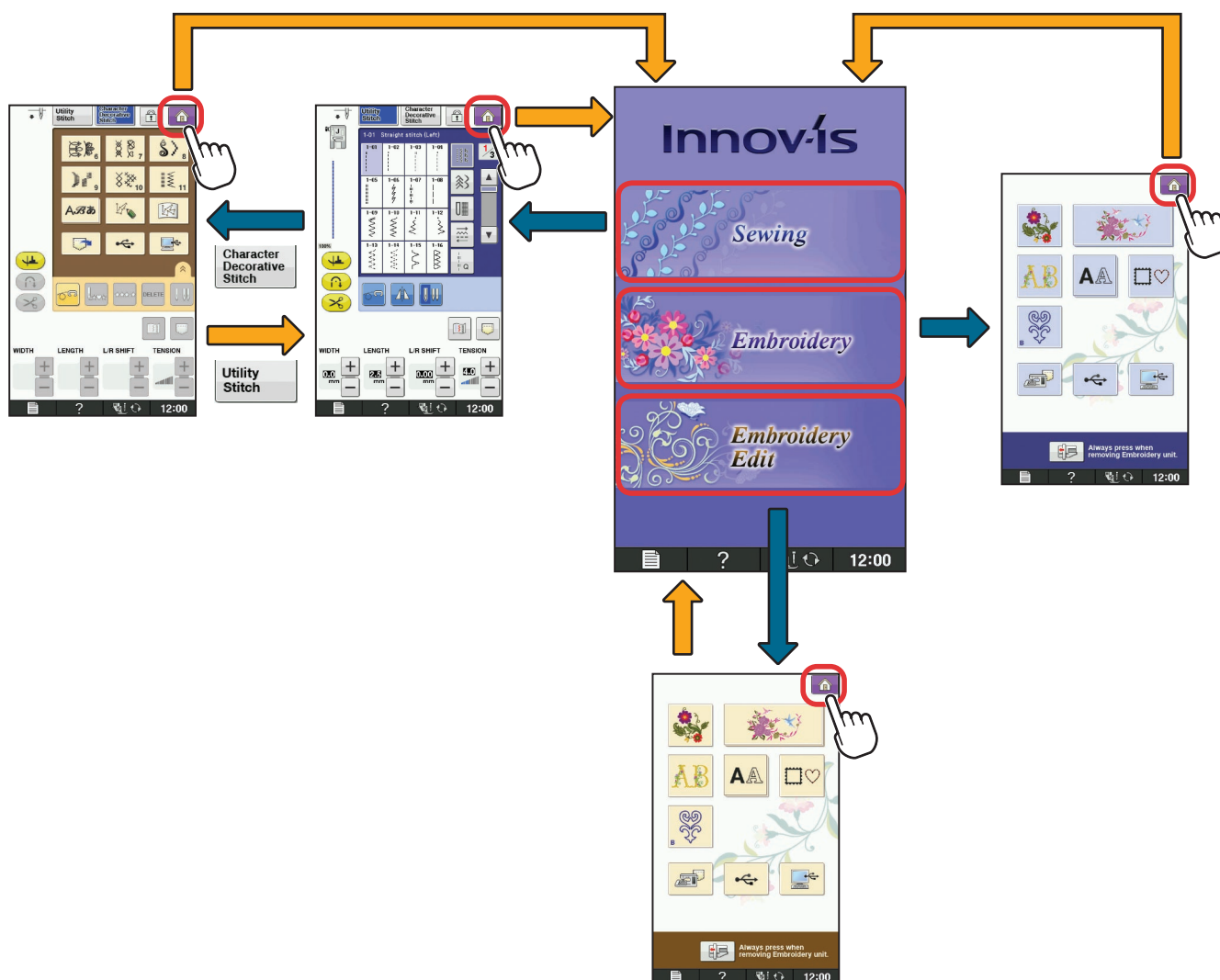

◆ Utility Stitches

When the machine is turned on, the opening movie is played. Touch the screen to display the home screen. Press **Settings** to display the Utility Stitch. Either "1-01 Straight stitch (Left)" or "1-03 Straight stitch (Middle)" is selected, depending on the setting selected in the settings screen.

◆ Points utiles

Quand la machine est mise sous tension, la vidéo de démarrage commence. Touchez l'écran pour afficher la page d'accueil. Appuyez sur **Centre** pour afficher le Point utilitaire. Soit « 1-01 Point droit (Gauche) », soit « 1-03 Point droit (Milieu) » est sélectionné, selon le réglage sélectionné sur l'écran de réglage.

◆ Punti utili

All'accensione della macchina, viene riprodotto il filmato di apertura. Toccare lo schermo per visualizzare la schermata iniziale. Premere **Centro** per visualizzare il punto utile. Viene selezionato "1-01 Punto diritto (Sinistra)" o "1-03 Punto diritto (Centro)", a seconda dell'impostazione selezionata nella schermata delle impostazioni.

◆ Nytte sømmer

Åpningsfilmen spilles av når du slår på maskinen. Berør skjermen for å vise startskjermen. Trykk **Samm** for å vise nyttesømmen. Enten "1-01 Rett søm (venstre)" eller "1-03 Rett søm (midten)" er valgt, avhengig av hvilken innstilling som er valgt på innstillingskjermen.

◆ Nutzstiche

Nach dem Einschalten der Maschine wird der Eingangsfilm angezeigt. Berühren Sie den Bildschirm zur Anzeige des Startbildschirms. Drücken Sie **Valien** zur Anzeige des Nutzstiches. Je nach Einstellung im Einstellbildschirm ist „1-01 Geradstich (Links)“ oder „1-03 Geradstich (Mitte)“ ausgewählt.

◆ Naaisteken

Wanneer u de machine aanzet, wordt de openingsfilm afgespeeld. Raak het scherm aan om het beginscherm weer te geven. Druk op **Naaien** om de naaistek weer te geven. Afhankelijk van de geselecteerde instelling in het instellingenscherm wordt ofwel "1-01 Rechte steek (links)" of "1-03 Rechte steek (midden)" geselecteerd.

◆ Puntadas utiles

Cuando se activa la máquina, se reproduce el video de presentación. Toque la pantalla para visualizar la pantalla inicial. Pulse **Centro** para visualizar la pantalla de puntada con aplicaciones. Se seleccionará la "Puntada recta 1-01 (izquierda)" o la "Puntada recta 1-03 (medio)", según el ajuste seleccionado en la pantalla de ajustes.

◆ Основные строчки

Когда машина включена, после проигрывания заставки отображается главный экран. Нажмите **Центр** для отображения Основной строчки. При этом выбирается "1-01 Прямая строчка (игла слева)" или "1-03 Прямая строчка (игла посередине)" в зависимости от настройки, выбранной на экране настроек.

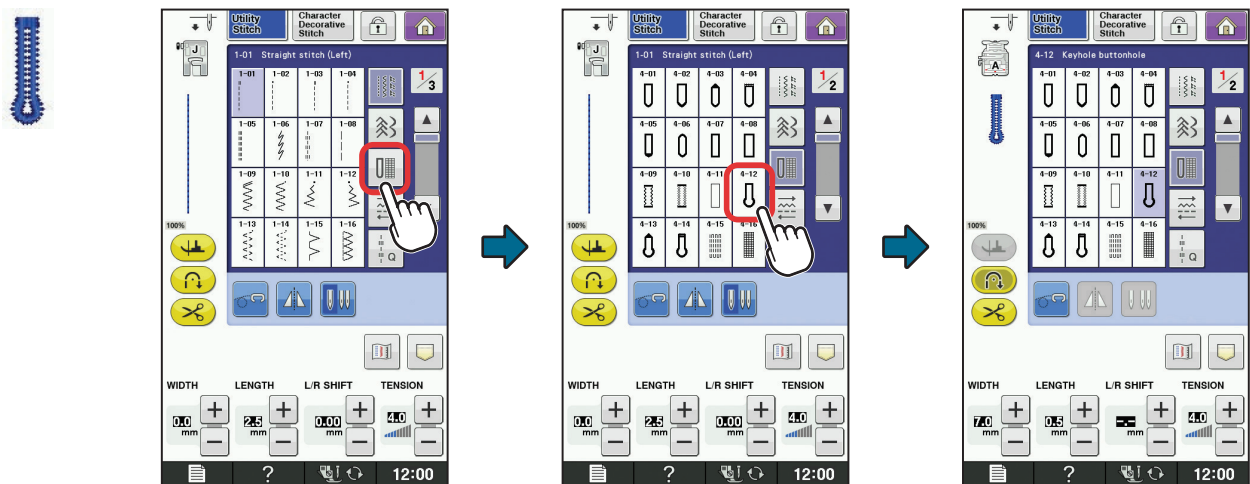

- ◆ Character/Decorative Stitches
- ◆ Caractères/points décoratifs
- ◆ Puntis per caratteri/decorazioni
- ◆ Bokstaver/Dekorative sømmer
- ◆ Buchstaben/Dekorative Stichmuster
- ◆ Letter/decoratieve steken
- ◆ Puntadas de letras/decorativas
- ◆ Знаки алфавита/декоративные строчки

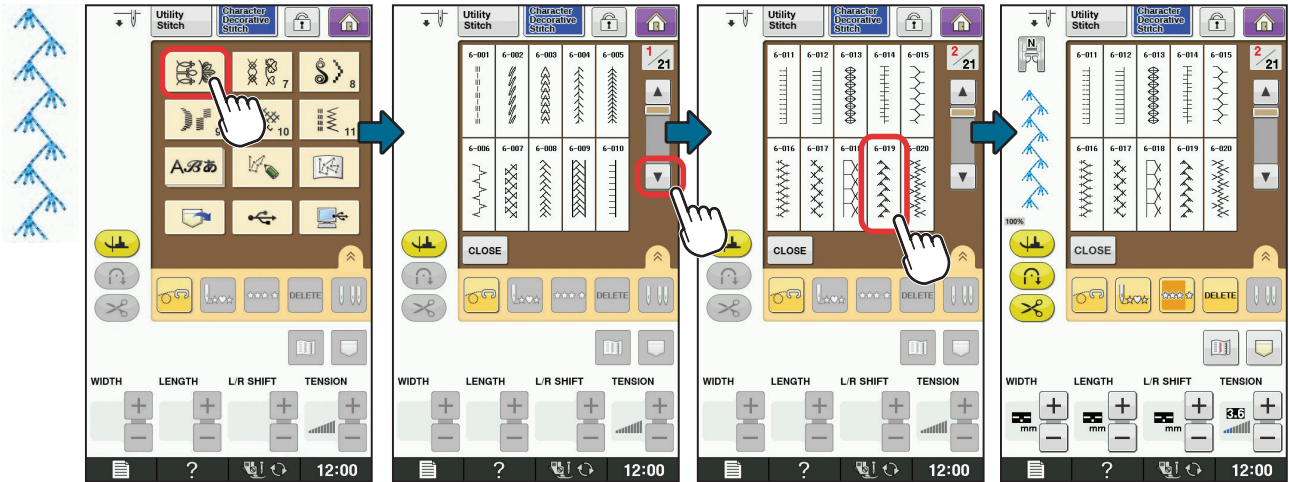

- ◆ Embroidery Patterns
- ◆ Motifs de broderie
- ◆ Schemi di ricamo
- ◆ Broderimønstre
- ◆ Stickmuster
- ◆ Borduurpatronen
- ◆ Patrones de bordado
- ◆ Рисунки для вышивания

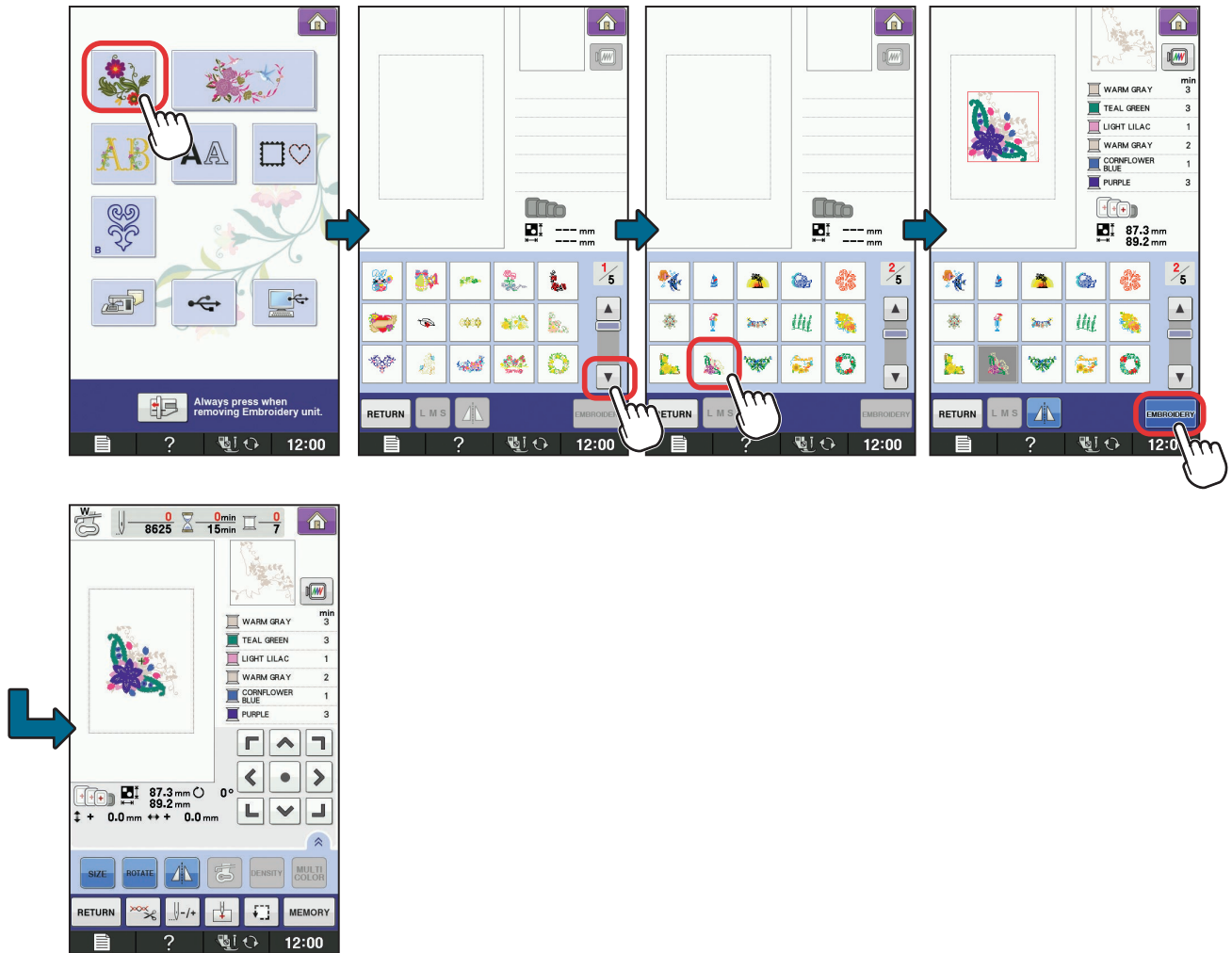

◆ Embroidery Edit Patterns

◆ Motifs de modification de broderie

◆ Schemi di modifica ricamo

◆ Redigere broderimønstre

◆ Editieren von Stickmustern

◆ Borduurbewerkingspatronen

◆ Patrones de edición de bordado

◆ Редактирование рисунков для вышивания



- ◆ Settings
- ◆ Réglages
- ◆ Impostazioni
- ◆ Innstillinger

- ◆ Einstellungen
- ◆ Instellingen
- ◆ Ajustes
- ◆ Настройки

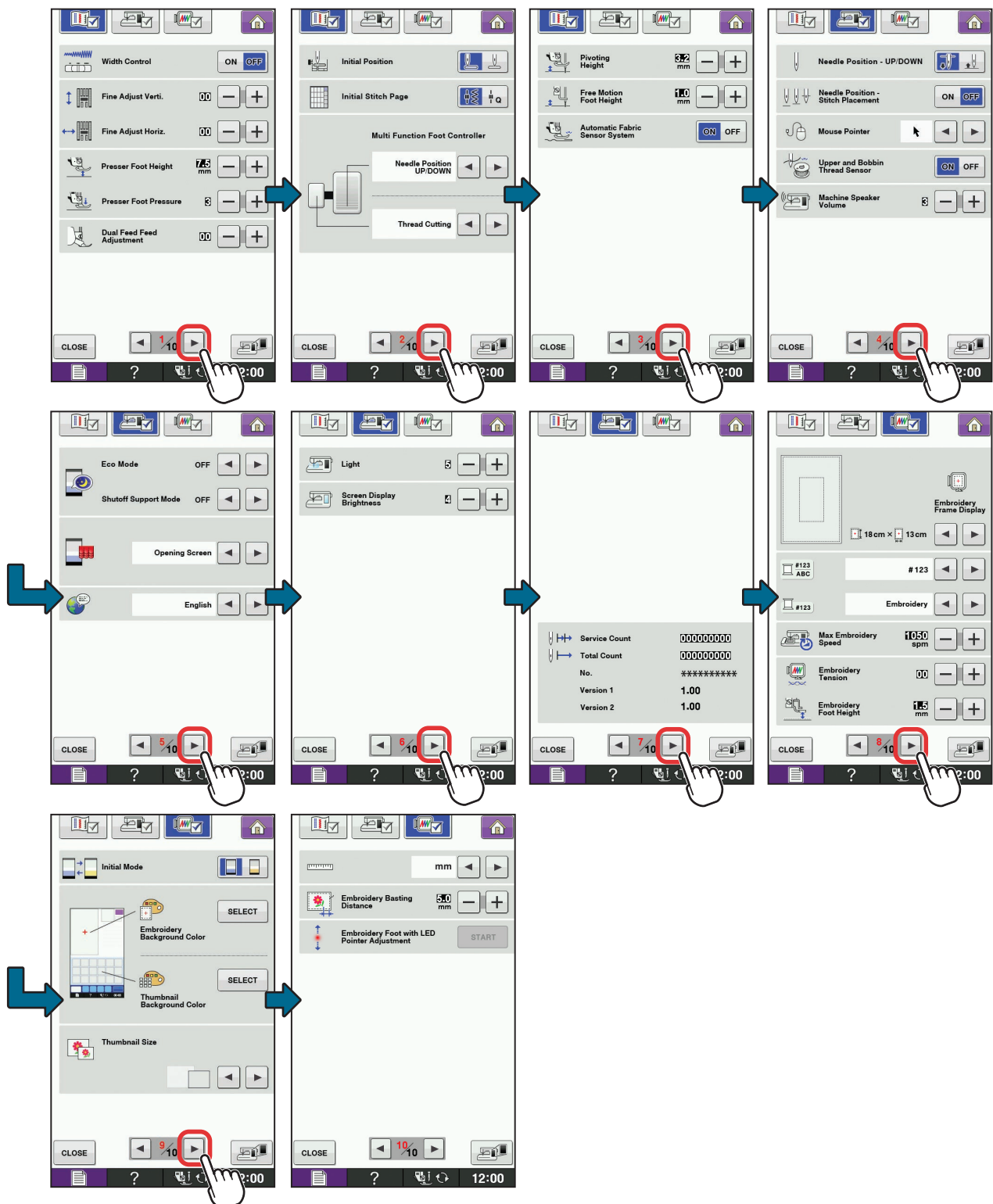

Summary of Stitch Patterns
 Sommaire des motifs de point
 Sommario degli schemi punto
 Oppsummering sømmer

Nähmuster-Übersicht
 Overzicht van de steekpatronen
 Resumen de tipos de puntada
 Виды строчек

◆ Utility Stitches

◆ Points utilitaires

◆ Punti utili

◆ Nyttesømmer

◆ Nutzstiche

◆ Naaisteken

◆ Puntadas utiles

◆ Основные строчки

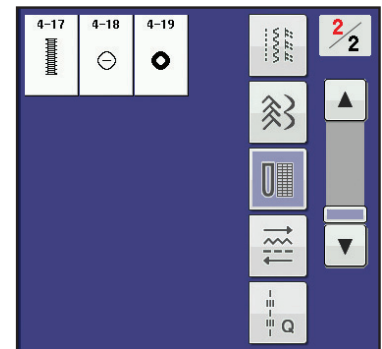
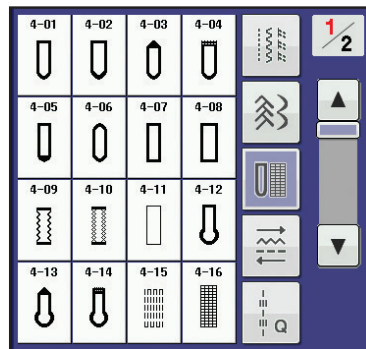
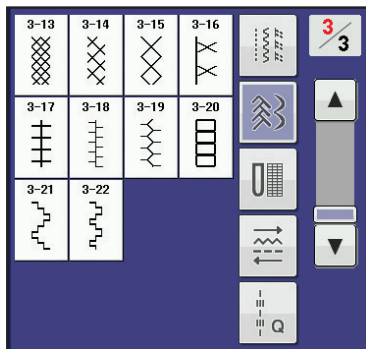
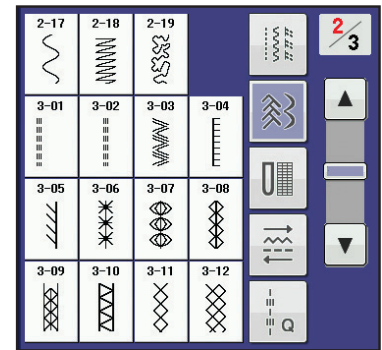
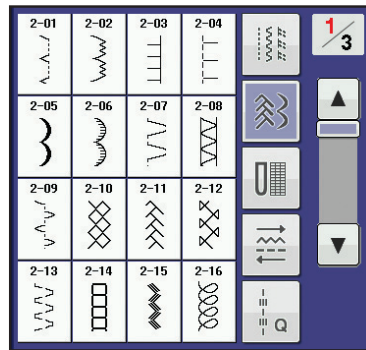
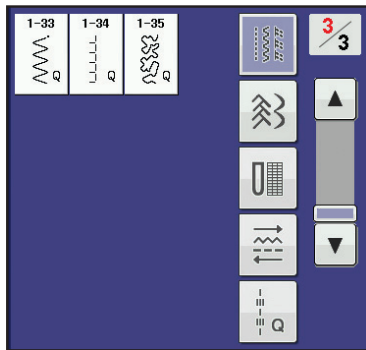
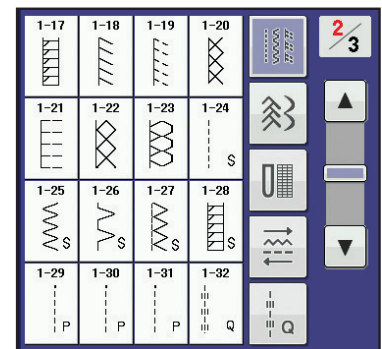
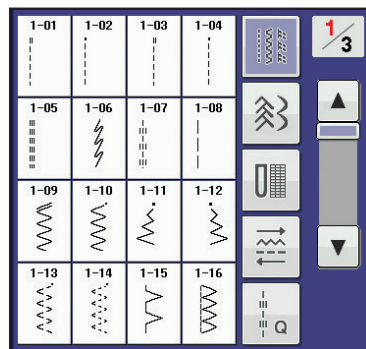
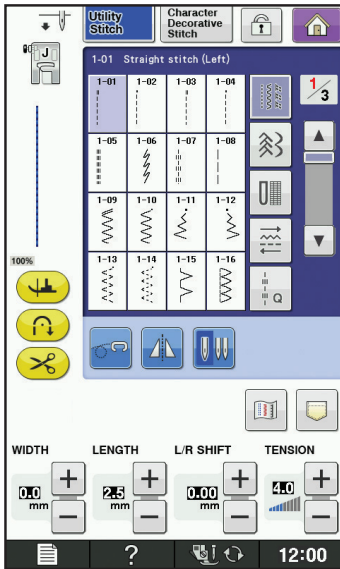

5-01 	5-02 	5-03 	5-04 	
5-05 	5-06 	5-07 	5-08 	
5-09 	5-10 	5-11 	5-12 	

Q-01 	Q-02 	Q-03 	Q-04 	 	1/2
Q-05 	Q-06 	Q-07 	Q-08 		▲
Q-09 	Q-10 	Q-11 	Q-12 		▼
Q-13 	Q-14 	Q-15 	Q-16 		

Q-17 	Q-18 	Q-19 	Q-20 	 	2/2
Q-21 	Q-22 	Q-23 	Q-24 		▲
Q-25 	Q-26 	Q-27 	Q-28 		▼
Q-29 	Q-30 				

◆ Character/Decorative Stitches

◆ Caractères/points décoratifs

◆ Puntis per caratteri/decorazioni

◆ Bokstaver/Dekorative sømmer

◆ Buchstaben/Dekorative Stichmuster

◆ Letter/decoratieve steken

◆ Puntadas de letras/decorativas

◆ Знаки алфавита/декоративные строчки

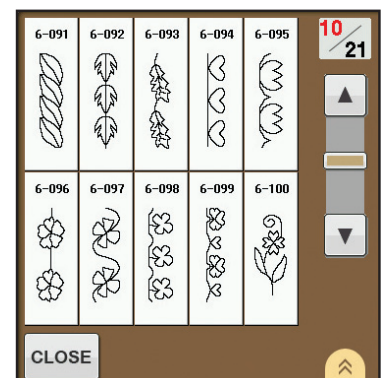
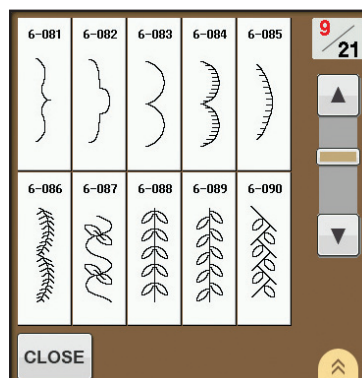
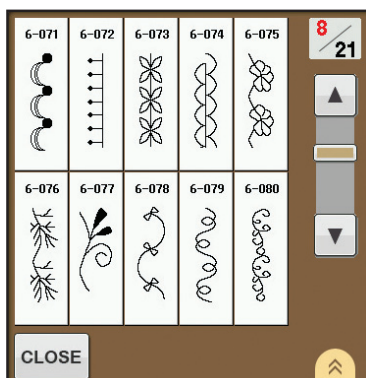
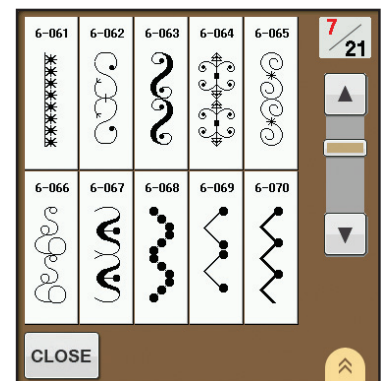
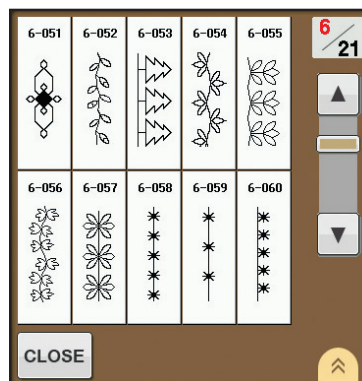
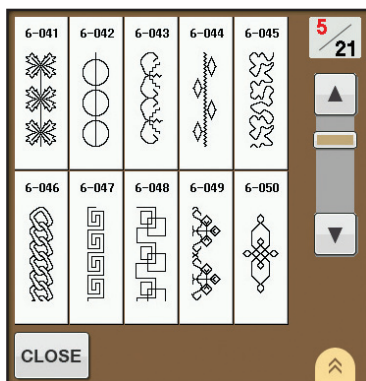
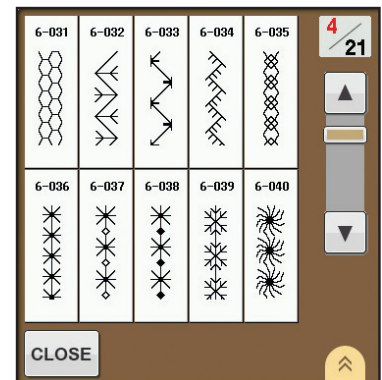
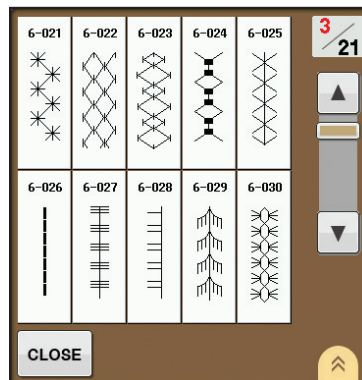
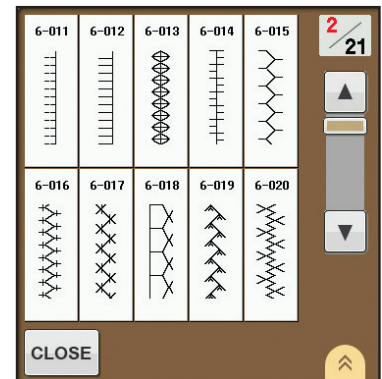
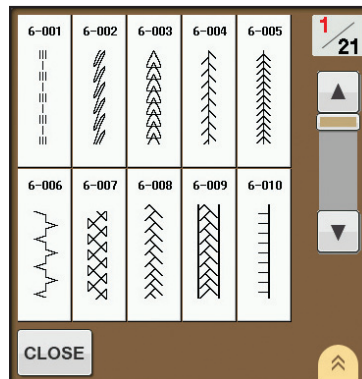
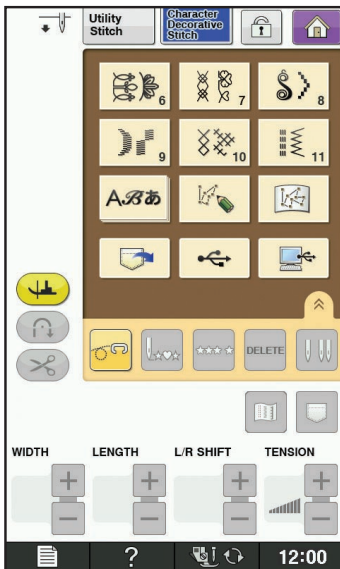

Summary of Stitch Patterns
 Nähmuster-Übersicht
 Sommaire des motifs de point
 Overzicht van de steekpatronen
 Sommario degli schemi punto
 Resumen de tipos de puntada
 Oppsummering sømmer
 Виды строчек

6-101	6-102	6-103	6-104	6-105	11 / 21
6-106	6-107	6-108	6-109	6-110	

CLOSE

6-111	6-112	6-113	6-114	6-115	12 / 21
6-116	6-117	6-118	6-119	6-120	

CLOSE

6-121	6-122	6-123	6-124	6-125	13 / 21
6-126	6-127	6-128	6-129	6-130	

CLOSE

6-131	6-132	6-133	6-134	6-135	14 / 21
6-136	6-137	6-138	6-139	6-140	

CLOSE

6-141	6-142	6-143	6-144	6-145	15 / 21
6-146	6-147	6-148	6-149	6-150	

CLOSE

6-151	6-152	6-153	6-154	6-155	16 / 21
6-156	6-157	6-158	6-159	6-160	

CLOSE

6-161	6-162	6-163	6-164	6-165	17 / 21
6-166	6-167	6-168	6-169	6-170	

CLOSE

6-171	6-172	6-173	6-174	6-175	18 / 21
6-176					

CLOSE

6-177	6-178	6-179	19 / 21

CLOSE

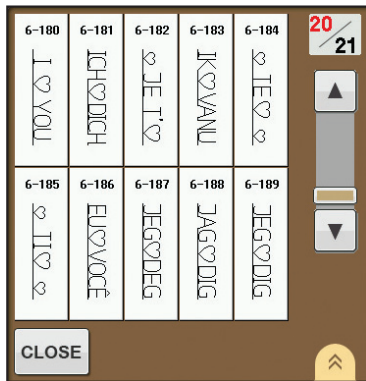

6-180: English
 6-181: German
 6-182: French
 6-183: Dutch
 6-184: Spanish
 6-185: Italian
 6-186: Portuguese
 6-187: Norwegian
 6-188: Swedish
 6-189: Danish
 6-190: Finnish
 6-191: Russian
 6-192: Thai
 6-193: Simplified Chinese
 6-194: Japanese

6-180: Englisch
 6-181: Deutsch
 6-182: Französisch
 6-183: Niederländisch
 6-184: Spanisch
 6-185: Italienisch
 6-186: Portugiesisch
 6-187: Norwegisch
 6-188: Schwedisch
 6-189: Dänisch
 6-190: Finnisch
 6-191: Russisch
 6-192: Thailändisch
 6-193: Vereinfachtes Chinesisch
 6-194: Japanisch

6-180 : anglais
 6-181 : allemand
 6-182 : français
 6-183 : néerlandais
 6-184 : espagnol
 6-185 : italien
 6-186 : portugais
 6-187 : norvégien
 6-188 : suédois
 6-189 : danois
 6-190 : finnois
 6-191 : russe
 6-192 : thaïlandais
 6-193 : chinois simplifié
 6-194 : japonais

6-180: Engels
 6-181: Duits
 6-182: Frans
 6-183: Nederlands
 6-184: Spaans
 6-185: Italiaans
 6-186: Portugees
 6-187: Noors
 6-188: Zweeds
 6-189: Deens
 6-190: Fins
 6-191: Russisch
 6-192: Thais
 6-193: Vereenvoudigd Chinees
 6-194: Japans

6-180: Inglese
 6-181: Tedesco
 6-182: Francese
 6-183: Olandese
 6-184: Spagnolo
 6-185: Italiano
 6-186: Portoghese
 6-187: Norvegese
 6-188: Svedese
 6-189: Danese
 6-190: Finlandese
 6-191: Russo
 6-192: Tailandese
 6-193: Cinese semplificato
 6-194: Giapponese

6-180: Inglés
 6-181: Alemán
 6-182: Francés
 6-183: Holandés
 6-184: Español
 6-185: Italiano
 6-186: Portugués
 6-187: Noruego
 6-188: Sueco
 6-189: Danés
 6-190: Finés
 6-191: Ruso
 6-192: Tailandés
 6-193: Chino simplificado
 6-194: Japonés

6-180: Engelsk
 6-181: Tysk
 6-182: Fransk
 6-183: Nederlansk
 6-184: Spansk
 6-185: Italiensk
 6-186: Portugisisk
 6-187: Norsk
 6-188: Svensk
 6-189: Dansk
 6-190: Finsk
 6-191: Russisk
 6-192: Thai
 6-193: Forenklet kinesisk
 6-194: Japansk

6-180: Английский
 6-181: Немецкий
 6-182: Французский
 6-183: Нидерландский
 6-184: Испанский
 6-185: Итальянский
 6-186: Португальский
 6-187: Норвежский
 6-188: Шведский
 6-189: Датский
 6-190: Финский
 6-191: Русский
 6-192: Тайский
 6-193: Китайский (упрощенный)
 6-194: Японский

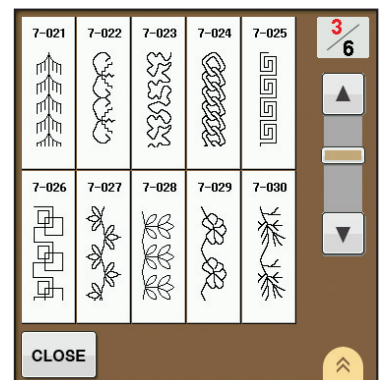
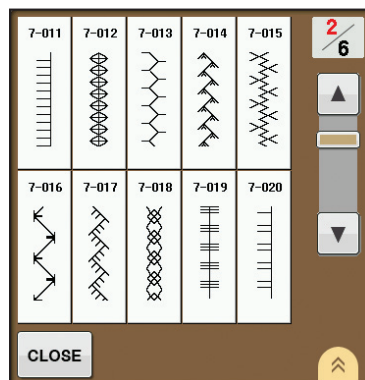
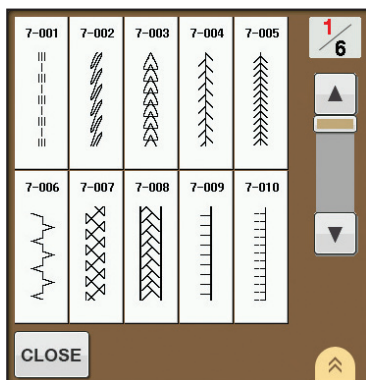
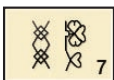

7-031	7-032	7-033	7-034	7-035	4/6	▲	▼	⏪	⏩
7-036	7-037	7-038	7-039	7-040					

CLOSE

7-041	7-042	7-043	7-044	7-045	5/6	▲	▼	⏪	⏩
7-046	7-047	7-048	7-049	7-050					

CLOSE

7-051	7-052				6/6	▲	▼	⏪	⏩

CLOSE



8-01	8-02	8-03	8-04	8-05	1/6	▲	▼	⏪	⏩
8-06	8-07	8-08	8-09	8-10					

CLOSE

8-11	8-12	8-13	8-14	8-15	2/6	▲	▼	⏪	⏩
8-16	8-17	8-18	8-19	8-20					

CLOSE

8-21	8-22	8-23	8-24	8-25	3/6	▲	▼	⏪	⏩
8-26	8-27	8-28	8-29	8-30					

CLOSE

8-31	8-32	8-33	8-34	8-35	4/6	▲	▼	⏪	⏩
8-36	8-37	8-38	8-39	8-40					

CLOSE

8-41	8-42	8-43	8-44	8-45	5/6	▲	▼	⏪	⏩
8-46	8-47	8-48	8-49	8-50					

CLOSE

8-51	8-52	8-53	8-54	8-55	6/6	▲	▼	⏪	⏩
8-56									

CLOSE



9-01	9-02	9-03	9-04	9-05	9-06	CLOSE	⏪	⏩
9-07	9-08	9-09	9-10	9-11	9-12			
9-13	9-14	9-15	9-16	9-17	9-18			
9-19	9-20							

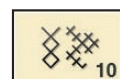

10-01	10-02	10-03	10-04	10-05	10-06	CLOSE	⏪	⏩
10-07	10-08	10-09	10-10	10-11	10-12			
10-13	10-14							

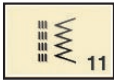

11-01	11-02	11-03	11-04	11-05
11-06	11-07	11-08	11-09	11-10
11-11	11-12	11-13	11-14	11-15
11-16	11-17	11-18	11-19	11-20

CLOSE

11-21	11-22	11-23	11-24	11-25
11-26	11-27	11-28	11-29	11-30
11-31	11-32	11-33	11-34	11-35
11-36	11-37	11-38	11-39	11-40

CLOSE

11-41	11-42	11-43	11-44	11-45
11-46	11-47	11-48	11-49	11-50
11-51	11-52	11-53	11-54	11-55
11-56	11-57	11-58		

CLOSE

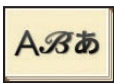

Utility Stitch | Character Decorative Stitch

AB *AB* AB

AB あア年組 0~9&?!

CLOSE

WIDTH LENGTH L/R SHIFT TENSION

12:00



A	B	C	D	E	ABC
F	G	H	I	J	abc
K	L	M	N	O	0-9,.
P	Q	R	S	T	&?!
U	V	W	X	Y	ÄÄä
Z	'	_			ÖÖö

CLOSE

α	b	c	d	e	ABC
f	g	h	i	j	abc
k	l	m	n	o	0-9,.
p	q	r	s	t	&?!
u	v	w	x	y	ÄÄä
z	'	_			ÖÖö

CLOSE

0	1	2	3	4	ABC
5	6	7	8	9	abc
#	%	\$	£	€	0-9,.
¥	-	+	X	÷	&?!
=	*	.	,	'	ÄÄä
_					ÖÖö

CLOSE

&	?	!	@	<	ABC
>	()	[]	abc
/	\	~	:	;	0-9,.
©	®	™	“	”	&?!
”	'	‘	’	_	ÄÄä
					ÖÖö

CLOSE

Â	Ä	Å	ä	å	ABC
â	ä	å	æ	Æ	abc
æ	Ç	ç	È	É	0-9,.
Ê	Ë	è	é	ê	&?!
ë	Ï	ï	İ	ı	ÄÄä
Ñ	ñ	Í	í	_	ÖÖö

CLOSE

Ô	Ö	Ø	ò	ó	ABC
ô	ö	ø	û	ü	abc
ù	ú	û	ü	þ	0-9,.
ƒ	B	i	İ	Ñ	&?!
Õ	õ	Œ	œ	ř	ÄÄä
ť	ž	'	_		ÖÖö

CLOSE

AB

A	B	C	D	E	ABC
F	G	H	I	J	abc
K	L	M	N	O	0-9,.
P	Q	R	S	T	&?!
U	V	W	X	Y	ÄÄä
Z	'	_			ÖÖö

CLOSE

a	b	c	d	e	ABC
f	g	h	i	j	abc
k	l	m	n	o	0-9,.
p	q	r	s	t	&?!
u	v	w	x	y	ÄÄä
z	'	_			ÖÖö

CLOSE

0	1	2	3	4	ABC
5	6	7	8	9	abc
#	%	\$	£	€	0-9,.
¥	-	+	×	÷	&?!
=	*	.	,	'	ÄÄä
_					ÖÖö

CLOSE

&	?	!	@	<	ABC
>	()	[]	abc
/	\	~	:	;	0-9,.
©	®	™	“	”	&?!
”	'	‘	’	_	ÄÄä
					ÖÖö

CLOSE

À	Á	Â	Ã	Ä	ABC
Å	Æ	Ç	È	É	abc
Ê	Ë	Ì	Í	Î	0-9,.
Ï	Ð	Ñ	Ò	Ó	&?!
Ô	Õ	Ö	×	÷	ÄÄä
			'	_	ÖÖö

CLOSE

Ô	Õ	Ö	×	÷	ABC
			'	_	abc
À	Á	Â	Ã	Ä	0-9,.
Å	Æ	Ç	È	É	&?!
Ê	Ë	Ì	Í	Î	ÄÄä
Ï	Ð	Ñ	Ò	Ó	ÖÖö

CLOSE

AB

A	B	C	D	E	ABC
F	G	H	I	J	abc
K	L	M	N	O	0-9,.
P	Q	R	S	T	&?!
U	V	W	X	Y	ÄÄä
Z	'	_			ÖÖö

CLOSE

a	b	c	d	e	ABC
f	g	h	i	j	abc
k	l	m	n	o	0-9,.
p	q	r	s	t	&?!
u	v	w	x	y	ÄÄä
z	'	_			ÖÖö

CLOSE

0	1	2	3	4	ABC
5	6	7	8	9	abc
#	%	\$	£	€	0-9,.
¥	-	+	×	÷	&?!
=	*	.	,	'	ÄÄä
_					ÖÖö

CLOSE

&	?	!	@	<	ABC
>	()	[]	abc
/	\	~	:	;	0-9,.
©	®	™	“	”	&?!
”	'	‘	’	_	ÄÄä
					ÖÖö

CLOSE

Â	Ã	Ä	Å	Æ	ABC
Ç	È	É	Ê	Ë	abc
Ì	Í	Î	Ï	Ð	0-9,.
Ñ	Ò	Ó	Ô	Õ	&?!
Ö	×	÷			ÄÄä
	'	_			ÖÖö

CLOSE

Ô	Õ	Ö	×	÷	ABC
			'	_	abc
Â	Ã	Ä	Å	Æ	0-9,.
Ç	È	É	Ê	Ë	&?!
Ì	Í	Î	Ï	Ð	ÄÄä
Ñ	Ò	Ó	Ô	Õ	ÖÖö

CLOSE

АБ

А	Б	В	Г	Д	АБВ
Е	Ё	Ж	З	И	ЧШЩ
Й	К	Л	М	Н	абв
О	П	Р	С	Т	чшщ
У	Ф	Х	Ц	—	0~9,.,

CLOSE

Ч	Ш	Щ	Ь	Ы	АБВ
Ь	Э	Ю	Я	Г	ЧШЩ
Е	І	Ї	Ў	Һ	абв
Һ	Ј	ЈЬ	Њ	Ц	чшщ
Ѓ	Ѕ	Ї	—		0~9,.,

CLOSE

а	б	в	г	д	АБВ
е	ё	ж	з	и	ЧШЩ
й	к	л	м	н	абв
о	п	р	с	т	чшщ
у	ф	х	ц	—	0~9,.,

CLOSE

Ч	Ш	Щ	Ь	Ы	АБВ
Ь	Э	Ю	Я	Г	ЧШЩ
Е	І	Ї	Ў	Һ	абв
Һ	Ј	ЈЬ	Њ	Ц	чшщ
Ѓ	Ѕ	Ї	—		0~9,.,

CLOSE

0	1	2	3	4	АБВ
5	6	7	8	9	ЧШЩ
—	.	,	&	?	абв
!	()	/	'	чшщ
—					0~9,.,

CLOSE

あア年組
0~9&?! *

あ	か	さ	た	な	あいう
は	ま	や	ら	わ	アイウ
あ	い	う	え	お	0~9 &?!
あ	い	う	え	お	年組
				—	

CLOSE H V

ア	カ	サ	タ	ナ	あいう
ハ	マ	ヤ	ラ	ワ	アイウ
ア	イ	ウ	エ	オ	0~9 &?!
ア	イ	ウ	エ	オ	年組
		ヴ		—	

CLOSE H V

0	1	2	3	4	あいう
5	6	7	8	9	アイウ
〇	一	二	三	四	0~9 &?!
五	六	七	八	九	年組
+	&	?	!	(
)	—			—	

CLOSE H V

生	年	月	日	才	あいう
小	中	学	校	組	アイウ
火	水	木	金	土	0~9 &?!
				—	年組

CLOSE H V

* Japanese characters
* Caratteri giapponesi

* Japanische Zeichen
* Caracteres japoneses

* Caractères japonais
* Japanske tegn

* Japanese tekens
* Японские иероглифы

◆ Embroidery Patterns

◆ Motifs de broderie

◆ Schemi di ricamo

◆ Broderimønstre

◆ Stickmuster

◆ Borduurpatronen

◆ Patrones de bordado

◆ Рисунки для вышивания

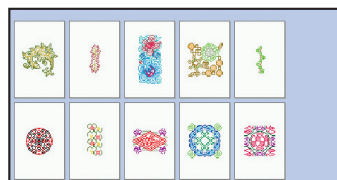
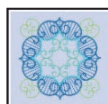
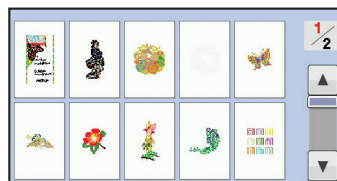
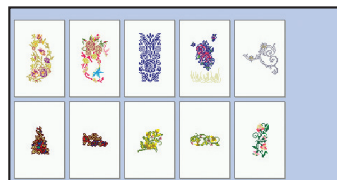
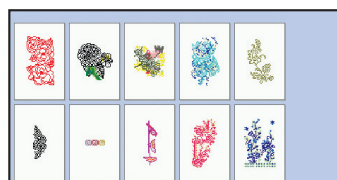
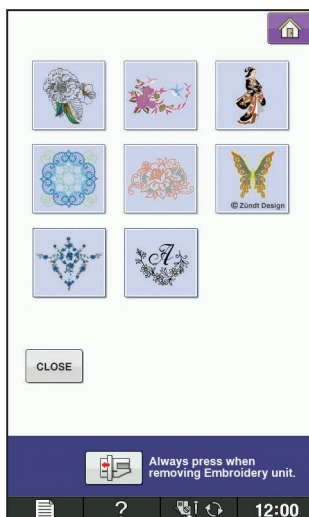
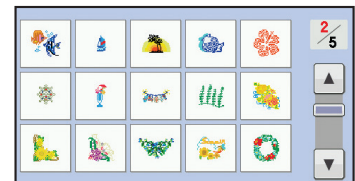
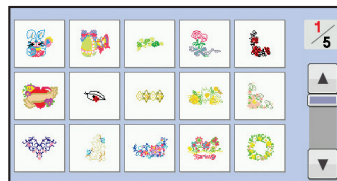
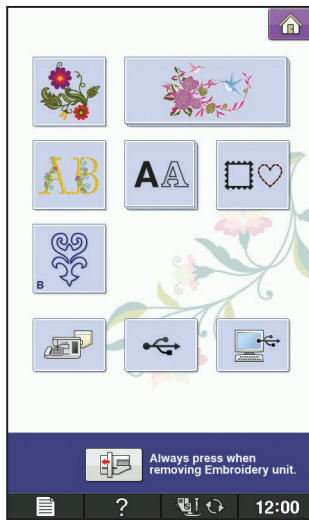

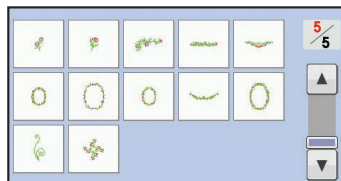
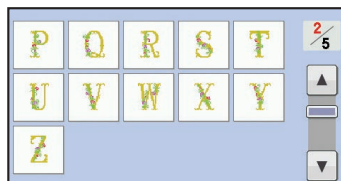
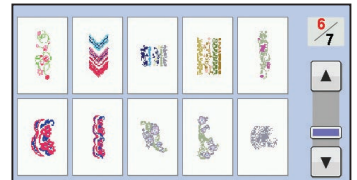
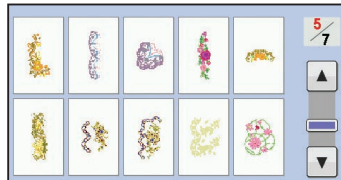
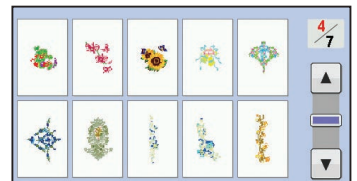
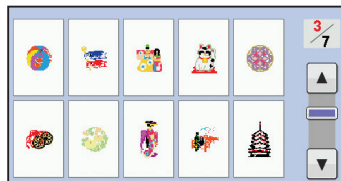
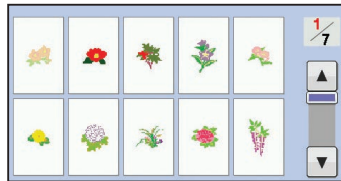
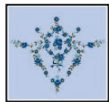
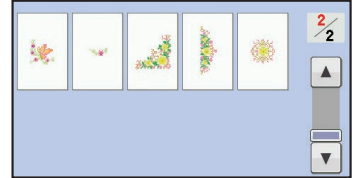
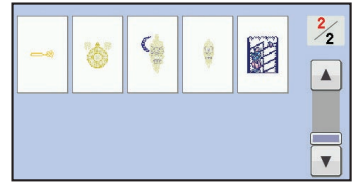
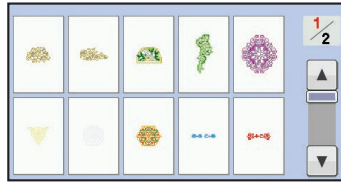

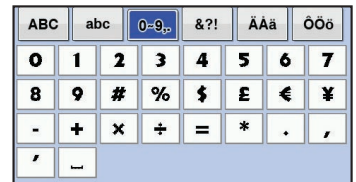
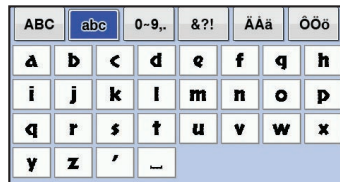
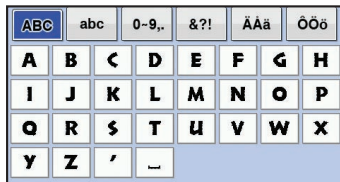
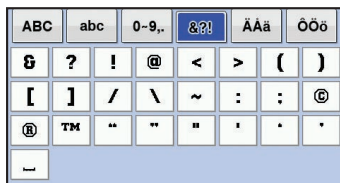
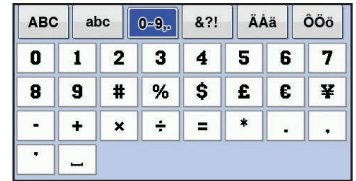
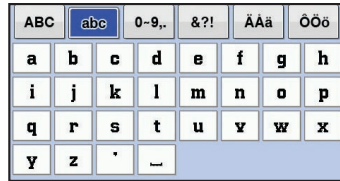
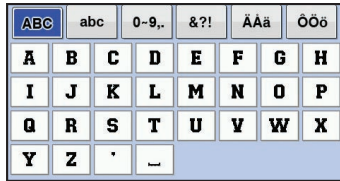
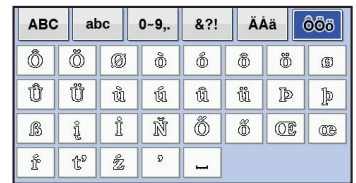
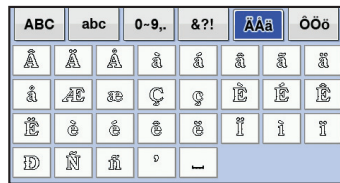
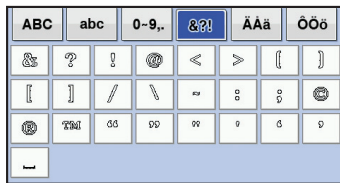
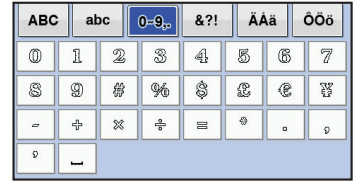
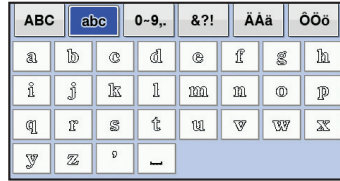
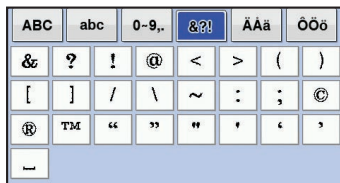
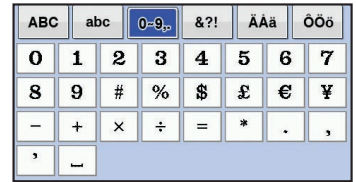
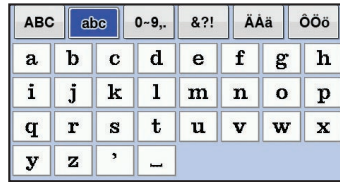
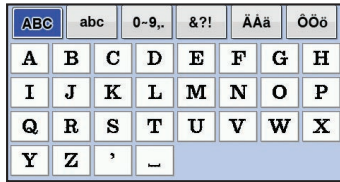
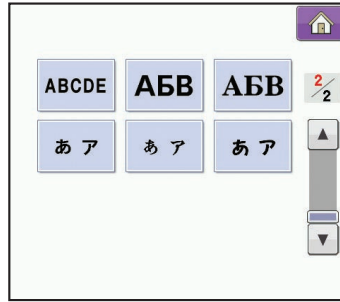
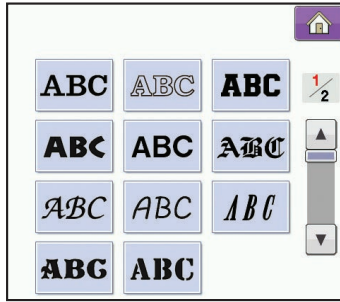

ABC	abc	0-9..	&?! &?!	ÄÄä	ÖÖö		
&	?	!	@	<	>	()
[]	/	\	~	:	;	©
®	™	"	"	"	'	'	'
—							

ABC	abc	0-9..	&?! ÄÄä	ÖÖö			
Ä	Ä	Ä	à	á	â	ã	ä
å	Æ	æ	Ç	ç	È	É	Ê
Ë	è	é	ê	ë	ï	ì	í
Ð	Ñ	ñ	'	—			

ABC	abc	0-9..	&?! ÄÄä	ÖÖö			
Ô	Õ	Ø	ò	ó	ô	ö	ø
Ù	Ú	ù	ú	û	ü	þ	þ
ß	ı	ı	Ń	Ń	ó	œ	œ
ř	ř	ž	'	—			

ABC

ABC	abc	0-9..	&?! ÄÄä	ÖÖö			
A	B	C	D	E	F	G	H
I	J	K	L	M	N	O	P
Q	R	S	T	U	V	W	X
Y	Z	'	—				

ABC	abc	0-9..	&?! ÄÄä	ÖÖö			
a	b	c	d	e	f	g	h
i	j	k	l	m	n	o	p
q	r	s	t	u	v	w	x
y	z	'	—				

ABC	abc	0-9..	&?! ÄÄä	ÖÖö			
0	1	2	3	4	5	6	7
8	9	#	%	\$	£	€	¥
-	+	x	÷	=	*	.	,
'	—						

ABC	abc	0-9..	&?! &?!	ÄÄä	ÖÖö		
&	?	!	@	<	>	()
[]	/	\	~	:	;	©
®	™	"	"	"	'	'	'
—							

ABC	abc	0-9..	&?! ÄÄä	ÖÖö			
Ä	Ä	Ä	à	á	â	ã	ä
å	Æ	æ	Ç	ç	È	É	Ê
Ë	è	é	ê	ë	ï	ì	í
Ð	Ñ	ñ	ı	ı	—		

ABC	abc	0-9..	&?! ÄÄä	ÖÖö			
Ô	Õ	Ø	ò	ó	ô	ö	ø
Ù	Ú	ù	ú	û	ü	þ	þ
ß	ı	ı	Ń	Ń	ó	œ	œ
ř	ř	ž	'	—			

ABC

ABC	abc	0-9..	&?! &?!				
À	Á	Â	Ã	Ä	Å	Æ	Ç
È	É	Ê	Ë	Ì	Í	Î	Ï
Ð	Ñ	Ò	Ó	Ô	Õ	Ö	×
Ø	Ù	Ú	Û	Ü	Ý	Þ	—

ABC	abc	0-9..	&?! &?!				
à	á	â	ã	ä	å	æ	ç
è	é	ê	ë	ì	í	î	ï
ð	ñ	ò	ó	ô	õ	ö	×
ø	ù	ú	û	ü	ý	þ	—

ABC	abc	0-9..	&?! &?!				
0	1	2	3	4	5	6	7
8	9	-	=	.	'	—	

ABC	abc	0-9..	&?! &?!				
&	?	!	<	>	[]	/
\	~	:	:	"	"	'	'
—							

ABC

ABC	abc	0-9..	&?! ÄÄä	ÖÖö			
À	Á	Â	Ã	Ä	Å	Æ	Ç
È	É	Ê	Ë	Ì	Í	Î	Ï
Ð	Ñ	Ò	Ó	Ô	Õ	Ö	×
Ø	Ù	Ú	Û	Ü	Ý	Þ	—

ABC	abc	0-9..	&?! ÄÄä	ÖÖö			
a	b	c	d	e	f	g	h
i	j	k	l	m	n	o	p
q	r	s	t	u	v	w	x
y	z	'	—				

ABC	abc	0-9..	&?! ÄÄä	ÖÖö			
0	1	2	3	4	5	6	7
8	9	#	%	\$	£	€	¥
-	+	x	÷	=	*	.	,
'	—						

ABC	abc	0-9..	&?! &?!	ÄÄä	ÖÖö		
À	?	!	@	<	>	()
[]	/	\	~	:	;	©
®	™	"	"	"	'	'	'
—							

ABC	abc	0-9..	&?! ÄÄä	ÖÖö			
À	À	À	à	á	â	ã	ä
å	Æ	æ	Ç	ç	È	É	Ê
Ë	è	é	ê	ë	ï	ì	í
Ð	Ñ	ñ	'	—			

ABC	abc	0-9..	&?! ÄÄä	ÖÖö			
Ô	Õ	Ø	ò	ó	ô	ö	ø
Ù	Ú	ù	ú	û	ü	þ	þ
ß	ı	ı	Ń	Ń	ó	œ	œ
ř	ř	ž	'	—			

ABC

ABC	abc	0-9..	&?! ÄÄä	ÖÖö			
A	B	C	D	E	F	G	H
I	J	K	L	M	N	O	P
Q	R	S	T	U	V	W	X
Y	Z	'	—				

ABC	abc	0-9..	&?! ÄÄä	ÖÖö			
a	b	c	d	e	f	g	h
i	j	k	l	m	n	o	p
q	r	s	t	u	v	w	x
y	z	'	—				

ABC	abc	0-9..	&?! ÄÄä	ÖÖö			
0	1	2	3	4	5	6	7
8	9	#	%	\$	£	€	¥
-	+	x	÷	=	*	.	,
'	—						

ABC	abc	0-9..	&?! &?!	ÄÄä	ÖÖö		
&	?	!	@	<	>	()
[]	/	\	~	:	;	©
®	™	"	"	"	'	'	'
—							

ABC	abc	0-9..	&?! ÄÄä	ÖÖö			
Ä	Ä	Ä	à	á	â	ã	ä
å	Æ	æ	Ç	ç	È	É	Ê
Ë	è	é	ê	ë	ï	ì	í
Ð	Ñ	ñ	'	—			

ABC	abc	0-9..	&?! ÄÄä	ÖÖö			
Ô	Õ	Ø	ò	ó	ô	ö	ø
Ù	Ú	ù	ú	û	ü	þ	þ
ß	ı	ı	Ń	Ń	ó	œ	œ
ř	ř	ž	'	—			

ABC

ABC	abc	0-9,.	&?!	ÄÄä	ÖÖö		
A	B	C	D	E	F	G	H
I	J	K	L	M	N	O	P
Q	R	S	T	U	V	W	X
Y	Z	'	_				

ABC	abc	0-9,.	&?!	ÄÄä	ÖÖö		
a	b	c	d	e	f	g	h
i	j	k	l	m	n	o	p
q	r	s	t	u	v	w	x
y	z	'	_				

ABC	abc	0-9,.	&?!	ÄÄä	ÖÖö		
0	1	2	3	4	5	6	7
8	9	#	%	\$	£	€	¥
-	+	x	÷	=	*	.	,
'	_						

ABC	abc	0-9,.	&?!	ÄÄä	ÖÖö		
&	?	!	@	<	>	()
[]	/	\	~	:	:	©
@	™	“	”	”	'	'	'
_							

ABC	abc	0-9,.	&?!	ÄÄä	ÖÖö		
Á	Ã	Ä	à	á	â	ã	ä
å	Æ	æ	Ç	ç	È	É	Ê
Ë	è	é	ê	ë	Ï	ì	í
Ð	Ñ	ñ	'	_			

ABC	abc	0-9,.	&?!	ÄÄä	ÖÖö		
Ó	Ô	Ø	ò	ó	ô	õ	ø
Ù	Û	ù	ú	û	ü	Ɔ	Ɔ
ß	ı	ı	Ń	Ń	õ	œ	œ
ř	ř	ž	'	_			

ABC

ABC	abc	0-9,.	&?!	ÄÄä	ÖÖö		
A	B	C	D	E	F	G	H
I	J	K	L	M	N	O	P
Q	R	S	T	U	V	W	X
Y	Z	'	_				

ABC	abc	0-9,.	&?!	ÄÄä	ÖÖö		
a	b	c	d	e	f	g	h
i	j	k	l	m	n	o	p
q	r	s	t	u	v	w	x
y	z	'	_				

ABC	abc	0-9,.	&?!	ÄÄä	ÖÖö		
0	1	2	3	4	5	6	7
8	9	#	%	\$	£	€	¥
-	+	x	÷	=	*	.	,
'	_						

ABC	abc	0-9,.	&?!	ÄÄä	ÖÖö		
&	?	!	@	<	>	()
[]	/	\	~	:	:	©
@	™	“	”	”	'	'	'
_							

ABC	abc	0-9,.	&?!	ÄÄä	ÖÖö		
À	Ã	Ä	à	á	â	ã	ä
å	Æ	æ	Ç	ç	È	É	Ê
Ë	è	é	ê	ë	Ï	ì	í
Ð	Ñ	ñ	'	_			

ABC	abc	0-9,.	&?!	ÄÄä	ÖÖö		
Ò	Ó	Ø	ò	ó	ô	õ	ø
Ù	Û	ù	ú	û	ü	Ɔ	Ɔ
ß	ı	ı	Ń	Ń	õ	œ	œ
ř	ř	ž	'	_			

ABC

ABC	abc	0-9,.	&?!	ÄÄä	ÖÖö		
A	B	C	D	E	F	G	H
I	J	K	L	M	N	O	P
Q	R	S	T	U	V	W	X
Y	Z	'	_				

ABC	abc	0-9,.	&?!	ÄÄä	ÖÖö		
a	b	c	d	e	f	g	h
i	j	k	l	m	n	o	p
q	r	s	t	u	v	w	x
y	z	'	_				

ABC	abc	0-9,.	&?!	ÄÄä	ÖÖö		
0	1	2	3	4	5	6	7
8	9	#	%	\$	£	€	¥
-	+	x	÷	=	*	.	,
'	_						

ABC	abc	0-9,.	&?!	ÄÄä	ÖÖö		
&	?	!	@	<	>	()
[]	/	\	~	:	:	©
@	™	“	”	”	'	'	'
_							

ABC	abc	0-9,.	&?!	ÄÄä	ÖÖö		
À	Ã	Ä	à	á	â	ã	ä
å	Æ	æ	Ç	ç	È	É	Ê
Ë	è	é	ê	ë	Ï	ì	í
Ð	Ñ	ñ	'	_			

ABC	abc	0-9,.	&?!	ÄÄä	ÖÖö		
Ò	Ó	Ø	ò	ó	ô	õ	ø
Ù	Û	ù	ú	û	ü	Ɔ	Ɔ
ß	ı	ı	Ń	Ń	õ	œ	œ
ř	ř	ž	'	_			

ABCDE

ABC	abc	0-9,.	&?!	ÄÄä	ÖÖö		
A	B	C	D	E	F	G	H
I	J	K	L	M	N	O	P
Q	R	S	T	U	V	W	X
Y	Z	'	_				

ABC	abc	0-9,.	&?!	ÄÄä	ÖÖö		
a	b	c	d	e	f	g	h
i	j	k	l	m	n	o	p
q	r	s	t	u	v	w	x
y	z	'	_				

ABC	abc	0-9,.	&?!	ÄÄä	ÖÖö		
0	1	2	3	4	5	6	7
8	9	#	%	\$	£	€	¥
-	+	x	÷	=	*	.	,
'	_						

ABC	abc	0-9,.	&?!	ÄÄä	ÖÖö		
&	?	!	@	<	>	()
[]	/	\	~	:	:	©
@	™	“	”	”	'	'	'
_							

ABC	abc	0-9,.	&?!	ÄÄä	ÖÖö		
À	Ã	Ä	à	á	â	ã	ä
å	Æ	æ	Ç	ç	È	É	Ê
Ë	è	é	ê	ë	Ï	ì	í
Ð	Ñ	ñ	'	_			

ABC	abc	0-9,.	&?!	ÄÄä	ÖÖö		
Ò	Ó	Ø	ò	ó	ô	õ	ø
Ù	Û	ù	ú	û	ü	Ɔ	Ɔ
ß	ı	ı	Ń	Ń	õ	œ	œ
ř	ř	ž	'	_			

АБВ

АБВ	ЧШЩ	абв	чшщ	0-9,.			
А	Б	В	Г	Д	Е	Ё	Ж
З	И	Й	К	Л	М	Н	О
П	Р	С	Т	У	Ф	Х	Ц
_							

АБВ	ЧШЩ	абв	чшщ	0-9,.			
Ч	Ш	Щ	Ъ	Ы	Ь	Э	Ю
Я	Ґ	Є	І	Ї	Ў	ґ	ґ
Ј	Љ	Њ	Џ	Ѓ	Ѕ	Ї	_
_							

АБВ	ЧШЩ	абв	чшщ	0-9,.			
а	б	в	г	д	е	ё	ж
з	и	й	к	л	м	н	о
п	р	с	т	у	ф	х	ц
_							

АБВ	ЧШЦ	абв	чшц	0-9,.
ч	ш	щ	ъ	ы
ь	э	ю	я	г
е	і	ї	ў	ђ
ђ	ј	љ	њ	џ
џ	џ	џ	џ	џ

АБВ	ЧШЦ	абв	чшц	0-9,.
0	1	2	3	4
5	6	7	8	9
-	.	,	&	?
!	()	/	'
—				

АБВ

АБВ	ЧШЦ	абв	чшц	0-9,.
А	Б	В	Г	Д
Е	Ё	Ж	З	И
Й	К	Л	М	Н
О	П	Р	С	Т
У	Ф	Х	Ц	—

АБВ	ЧШЦ	абв	чшц	0-9,.
Ч	Ш	Щ	Ъ	Ы
Ь	Э	Ю	Я	Г
Е	І	Ї	Ў	Ђ
Ђ	Ј	Љ	Њ	Џ
Џ	Џ	Џ	Џ	Џ

АБВ	ЧШЦ	абв	чшц	0-9,.
а	б	в	г	д
е	ё	ж	з	и
й	к	л	м	н
о	п	р	с	т
у	ф	х	ц	—

АБВ	ЧШЦ	абв	чшц	0-9,.
ч	ш	щ	ъ	ы
ь	э	ю	я	г
е	і	ї	ў	ђ
ђ	ј	љ	њ	џ
џ	џ	џ	џ	џ

АБВ	ЧШЦ	абв	чшц	0-9,.
0	1	2	3	4
5	6	7	8	9
-	.	,	&	?
!	()	/	'
—				

あア

*
 Katakana characters: One of the character sets of Japanese.
 Katakana-Zeichen: Einer der Zeichensätze für Japanisch.
 Caractères Katakana : l'un des jeux de caractères japonais.
 Catalaan-tekens: een van de tekensets van Japans.
 Caratteri Katakana: uno dei set di caratteri della lingua giapponese.
 Caracteres Katakana: uno de los grupos de caracteres del japonés.
 Katakana-tegn: Ett av de japanske tegnsettene.
 Катакана: один из наборов символов (азбука) в японском языке.

Hiragana characters: One of the character sets of Japanese.
 Hiragana-Zeichen: Einer der Zeichensätze für Japanisch.
 Caractères Hiragana : l'un des jeux de caractères japonais.
 Hiragana-tekens: een van de tekensets van Japans.
 Caratteri Hiragana: uno dei set di caratteri della lingua giapponese.
 Caracteres Hiragana: uno de los grupos de caracteres del japonés.
 Hiragana-tegn: Ett av de japanske tegnsettene.
 Хирагана: один из наборов символов (азбука) в японском языке.

Arabic numerals, Japanese Kanji numerals
 Arabische Ziffern, japanische Kanji-Ziffern
 Chiffres arabes, chiffres Kanji japonais
 Arabische cijfers, Japanse Kanji-cijfers
 Numeri arabi, numeri Kanji giapponesi
 Números arábigos, números Kanji japoneses
 Arabiske tall, japanske Kanji-tall
 Арабские цифры и иероглифы кандзи

Kanji characters often used in daily life / symbols.
 Im Alltag häufig verwendete Kanji-Zeichen / Symbole.
 Les caractères Kanji sont souvent utilisés dans la vie de tous les jours / symboles.
 Kanji-tekens worden vaak gebruikt in het dagelijks leven / symbolen.
 Caratteri Kanji spesso utilizzati nella vita quotidiana / simboli.
 Los caracteres Kanji se utilizan a menudo en la vida diaria / como símbolos.
 Kanji-tegn brukes ofte til daglig / symboler.

Иероглифы кандзи часто используются в повседневной жизни или как символы.

あいう	アイウ	0-9 &?!	年組	H V
あ	い	う	え	お
あ	い	う	え	お

Horizontal
 Horizontal
 Horizontal
 Horizontal
 Orizzontale
 Horizontal
 Horizontal
 По горизонтали

Vertical
 Vertikal
 Vertical
 Vertical
 Verticaal
 Verticale
 Vertical
 Vertical
 По вертикали

あいう	アイウ	0-9 &?!	年組	H V
あ	い	う	え	お
あ	い	う	え	お

あいう	アイウ	0-9 &?!	年組	H V
あ	い	う	え	お
か	き	く	け	こ
が	ぎ	ぐ	げ	ご

あいう	アイウ	0-9 &?!	年組	H V
あ	い	う	え	お
さ	し	す	せ	そ
が	じ	ず	ぜ	ぞ

あいう	アイウ	0-9 &?!	年組	H V
あ	い	う	え	お
た	ち	つ	て	と
だ	ぢ	づ	で	ど
			っ	

あいう	アイウ	0-9 &?!	年組	H V
あ	い	う	え	お
な	に	ぬ	ね	の

あいう	アイウ	0-9 &?!	年組	H V
あ	い	う	え	お
は	ひ	ふ	へ	ほ
ば	び	ぶ	べ	ぼ
ば	び	ぶ	べ	ぼ

あいう	アイウ	0-9 &?!	年組	H	V
あ	か	さ	た	な	は
ま	み	む	め	も	

あいう	アイウ	0-9 &?!	年組	H	V
あ	か	さ	た	な	は
や	ゆ	よ			

あいう	アイウ	0-9 &?!	年組	H	V
あ	か	さ	た	な	は
ら	り	る	れ	ろ	

あいう	アイウ	0-9 &?!	年組	H	V
あ	か	さ	た	な	は
わ	を	ん			

あいう	アイウ	0-9 &?!	年組	H	V
ア	カ	サ	タ	ナ	ハ
ア	イ	ウ	エ	オ	

あいう	アイウ	0-9 &?!	年組	H	V
ア	カ	キ	ク	ケ	コ
ガ	ギ	グ	ゲ	ゴ	

あいう	アイウ	0-9 &?!	年組	H	V
ア	カ	シ	ス	セ	ソ
ザ	ジ	ズ	ゼ	ゾ	

あいう	アイウ	0-9 &?!	年組	H	V
ア	カ	チ	ツ	テ	ト
ダ	ヂ	ヅ	デ	ド	

あいう	アイウ	0-9 &?!	年組	H	V
ア	カ	ニ	ヌ	ネ	ノ

あいう	アイウ	0-9 &?!	年組	H	V
ア	カ	ヒ	フ	ヘ	ホ
バ	ビ	ブ	ベ	ボ	

あいう	アイウ	0-9 &?!	年組	H	V
ア	カ	ミ	ム	メ	モ

あいう	アイウ	0-9 &?!	年組	H	V
ヤ	ユ	ヨ			

あいう	アイウ	0-9 &?!	年組	H	V
ア	カ	ラ	リ	ル	レ
ラ	リ	ル	レ	ロ	

あいう	アイウ	0-9 &?!	年組	H	V
ア	カ	ワ	ヲ	ン	

あいう	アイウ	0-9 &?!	年組	H	V
0	1	2	3	4	5
6	7	8	9	〇	ー
二	三	四	五	六	七
八	九	十	&	?	!
()	ー			

あいう	アイウ	0-9 &?!	年組	H	V
生	年	月	日	才	小
校	組	火	水	木	金
育	幼	稚	園	番	部
係	名	前			

あア *

あいう	アイウ	0-9 &?!	年組	H	V
あ	い	う	え	お	
あ	い	う	え	お	

あいう	アイウ	0-9 &?!	年組	H	V
か	き	く	け	こ	
が	ぎ	ぐ	げ	ご	

あいう	アイウ	0-9 &?!	年組	H	V
さ	し	す	せ	そ	
ざ	じ	ず	ぜ	ぞ	

あいう	アイウ	0-9 &?!	年組	H	V
た	ち	つ	て	と	
だ	ぢ	づ	で	ど	

あいう	アイウ	0-9 &?!	年組	H	V
な	に	ぬ	ね	の	

あいう	アイウ	0-9 &?!	年組	H	V
は	ひ	ふ	へ	ほ	
ば	び	ぶ	べ	ぼ	

* Japanese characters
 * Caratteri giapponesi

* Japanische Zeichen
 * Caracteres japoneses

* Caractères japonais
 * Japanske tegn

* Japanse tekens
 * Японские иероглифы

あいう	アイウ	0-9 &?!	年組	H	V
あ	か	さ	た	な	は
ま	み	む	め	も	

あいう	アイウ	0-9 &?!	年組	H	V
あ	か	さ	た	な	は
や	ゆ	よ			

あいう	アイウ	0-9 &?!	年組	H	V
あ	か	さ	た	な	は
ら	り	る	れ	る	

あいう	アイウ	0-9 &?!	年組	H	V
あ	か	さ	た	な	は
わ	を	ん			

あいう	アイウ	0-9 &?!	年組	H	V
ア	カ	サ	タ	ナ	ハ
ア	イ	ウ	エ	オ	

あいう	アイウ	0-9 &?!	年組	H	V
ア	カ	キ	ク	ケ	コ
ガ	ギ	グ	ゲ	ゴ	

あいう	アイウ	0-9 &?!	年組	H	V
ア	カ	シ	ス	セ	ソ
ザ	ジ	ズ	ゼ	ゾ	

あいう	アイウ	0-9 &?!	年組	H	V
ア	カ	サ	タ	ナ	ハ
タ	チ	ツ	テ	ト	

あいう	アイウ	0-9 &?!	年組	H	V
ア	カ	サ	タ	ナ	ハ
ナ	ニ	ヌ	ネ	ノ	

あいう	アイウ	0-9 &?!	年組	H	V
ア	カ	ハ	ヒ	フ	ヘ
バ	ビ	ブ	ベ	ボ	

あいう	アイウ	0-9 &?!	年組	H	V
ア	カ	サ	タ	ナ	ハ
マ	ミ	ム	メ	モ	

あいう	アイウ	0-9 &?!	年組	H	V
ア	カ	サ	タ	ナ	ハ
ヤ	ユ	ヨ			

あいう	アイウ	0-9 &?!	年組	H	V
ア	カ	ラ	リ	ル	レ
ラ	リ	ル	レ	ロ	

あいう	アイウ	0-9 &?!	年組	H	V
ア	カ	サ	タ	ナ	ハ
ワ	ヲ	ン			

あいう	アイウ	0-9 &?!	年組	H	V
0	1	2	3	4	5
6	7	8	9	0	ー

あいう	アイウ	0-9 &?!	年組	H	V
生	年	月	日	オ	小
校	組	火	水	木	金

あア *

あいう	アイウ	0-9 &?!	年組	H	V
あ	い	う	え	お	
あ	い	う	え	お	

あいう	アイウ	0-9 &?!	年組	H	V
あ	か	き	く	け	こ
が	ぎ	ぐ	げ	ご	

あいう	アイウ	0-9 &?!	年組	H	V
あ	か	さ	し	す	せ
ざ	じ	ず	ぜ	ぞ	

あいう	アイウ	0-9 &?!	年組	H	V
あ	か	さ	た	な	は
た	ち	つ	て	と	

あいう	アイウ	0-9 &?!	年組	H	V
あ	か	さ	た	な	は
な	に	ぬ	ね	の	

あいう	アイウ	0-9 &?!	年組	H	V
あ	か	さ	た	な	は
は	ひ	ふ	へ	ほ	

* Japanese characters
* Caratteri giapponesi

* Japanische Zeichen
* Caracteres japoneses

* Caractères japonais
* Japanske tegn

* Japanse tekens
* Японские иероглифы

あいう アイウ 0-9 &?! 年組 H V

あ	か	さ	た	な	は	ま	や	ら	わ
ま	み	む	め	も					

あいう アイウ 0-9 &?! 年組 H V

あ	か	さ	た	な	は	ま	や	ら	わ
や	ゆ	よ							
や	ゆ	よ							

あいう アイウ 0-9 &?! 年組 H V

あ	か	さ	た	な	は	ま	や	ら	わ
ら	り	る	れ	ろ					

あいう アイウ 0-9 &?! 年組 H V

あ	か	さ	た	な	は	ま	や	ら	わ
わ	を	ん							

あいう アイウ 0-9 &?! 年組 H V

ア	カ	サ	タ	ナ	ハ	マ	ヤ	ラ	ワ
ア	イ	ウ	エ	オ					
ア	イ	ウ	エ	オ					

あいう アイウ 0-9 &?! 年組 H V

ア	カ	サ	タ	ナ	ハ	マ	ヤ	ラ	ワ
カ	キ	ク	ケ	コ					
ガ	ギ	グ	ゲ	ゴ					

あいう アイウ 0-9 &?! 年組 H V

ア	カ	サ	タ	ナ	ハ	マ	ヤ	ラ	ワ
サ	シ	ス	セ	ソ					
ザ	ジ	ズ	ゼ	ゾ					

あいう アイウ 0-9 &?! 年組 H V

ア	カ	サ	タ	ナ	ハ	マ	ヤ	ラ	ワ
タ	チ	ツ	テ	ト					
ダ	ヂ	ヅ	デ	ド					

あいう アイウ 0-9 &?! 年組 H V

ア	カ	サ	タ	ナ	ハ	マ	ヤ	ラ	ワ
ナ	ニ	ヌ	ネ	ノ					

あいう アイウ 0-9 &?! 年組 H V

ア	カ	サ	タ	ナ	ハ	マ	ヤ	ラ	ワ
ハ	ヒ	フ	ヘ	ホ					
バ	ビ	ブ	ベ	ボ					
パ	ピ	プ	ペ	ポ					

あいう アイウ 0-9 &?! 年組 H V

ア	カ	サ	タ	ナ	ハ	マ	ヤ	ラ	ワ
マ	ミ	ム	メ	モ					

あいう アイウ 0-9 &?! 年組 H V

ア	カ	サ	タ	ナ	ハ	マ	ヤ	ラ	ワ
ヤ	ユ	ヨ							
ヤ	ユ	ヨ							

あいう アイウ 0-9 &?! 年組 H V

ア	カ	サ	タ	ナ	ハ	マ	ヤ	ラ	ワ
ラ	リ	ル	レ	ロ					

あいう アイウ 0-9 &?! 年組 H V

ア	カ	サ	タ	ナ	ハ	マ	ヤ	ラ	ワ
ワ	ヲ	ン							

あいう アイウ 0-9 &?! 年組 H V

0	1	2	3	4	5	6	7		
8	9	0	-	ニ	三	四	五		
六	七	八	九	+					
&	?	!	()	-				

あいう アイウ 0-9 &?! 年組 H V

生	年	月	日	才	小	中	学		
校	組	火	水	木	金	土	保		
育	幼	稚	園	番	部	班	会		
係	名	前							

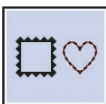

○	□	◇	○	□	▽	▽	○	▽	□
○	○	○	○	○					
○	○	○	○	○					
○	○	○	○						

○	□	◇	○	□	▽	▽	○	▽	□
□	□	□	□	□					
□	□	□	□	□					
□	□	□	□						

○	□	◇	○	□	▽	▽	○	▽	□
◇	◇	◇	◇	◇					
◇	◇	◇	◇	◇					
◇	◇	◇	◇						

○	□	◇	○	□	▽	▽	○	▽	□
○	○	○	○	○					
○	○	○	○	○					
○	○	○	○						

○	□	◇	○	□	▽	▽	○	▽	□
□	□	□	□	□					
□	□	□	□	□					
□	□	□	□						

○	□	◇	○	□	▽	▽	○	▽	□
▽	▽	▽	▽	▽					
▽	▽	▽	▽	▽					
▽	▽	▽	▽						

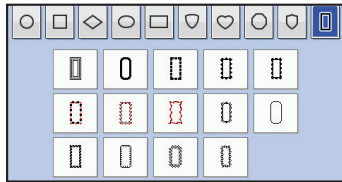
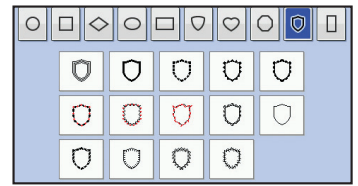
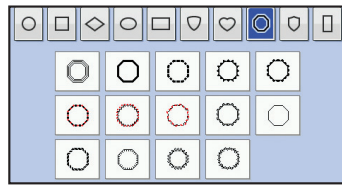
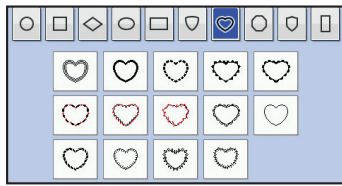

Embroidery Pattern Color Change Table

Tableau de changement de couleur des motifs de broderie

Tabella di cambiamento colori degli schemi di ricamo

Fargeoppsett broderimønstre

Stickmuster-Farbtabelle

Kleurwijzigingstabel voor de borduurpatronen

Tabla de cambio de color para patrones de bordado

Таблицы цветов нитей для вышивок

◆ Embroidery patterns

◆ Motifs de broderie

◆ Schemi di ricamo

◆ Broderimønstre

◆ Stickmuster

◆ Borduurpatronen

◆ Patrones de bordado

◆ Рисунки для вышивания



- "Four Seasons" designs
- Motifs « Quatre saisons »
- Disegni "Quattro stagioni"
- "Fire årstider"-design

- Designs „Vier Jahreszeiten“
- "Vier seizoenen" ontwerpen
- Diseños "Cuatro estaciones"
- Рисунки "Четыре времени года"

No.1 13 min

Order to embroider
Stickreihenfolge
Séquence pour broder
Borduurvolgorde
Sequenza operazioni di ricamo
Orden para el bordador
Broderingsrekkefølge
Порядок вышивания

1	(124)
2	(001)
3	(086)
4	(001)
5	(017)
6	(612)
7	(085)
8	(205)
9	(019)
10	(900)

Embroidery thread color
Stickgarnfarbe
Couleur du fil de broderie
Kleur borduurdraad
Colore filo ricamo
Color del hilo de bordado
Broderitrådfarge
Цвет нити для вышивания

Time required for embroidering
Zeitaufwand beim Stickten
Durée requise pour broder
Tijd benodigd voor het borduren
Tempo di ricamo necessario
Tiempo requerido para el bordado
Tidforbruk for brodering
Время, необходимое для вышивания

Embroidery thread color number
Stickgarn-Farbnummer
Numéro de couleur du fil de broderie
Kleurnummer borduurdraad
Numero colori filo per ricamo
Número de color del hilo de bordado
Nummer for broderitrådfargen
Номер цвета нити для вышивания

Embroidery size
Größe der Stickerei
Taille de la broderie
Borduurgrootte
Dimensioni del ricamo
Tecla de tamaño
Broderistørrelse
Размер вышивки

↓ 67.2 mm
↔ 66.3 mm

No.8 7 min

1	(502)
2	(812)
3	(079)
4	(328)
5	(330)
6	(126)
7	(206)
8	(328)

↓ 40.8 mm
↔ 83.1 mm

No.9 15 min

1	(502)
2	(513)
3	(812)
4	(348)
5	(126)
6	(206)
7	(348)
8	(843)

↓ 57.7 mm
↔ 104.2 mm

No.10 12 min

1	(124)
2	(513)
3	(005)
4	(079)
5	(086)
6	(206)

↓ 90.9 mm
↔ 90.5 mm

No.11 9 min

1	(406)
2	(810)
3	(085)
4	(202)

↓ 66.0 mm
↔ 99.7 mm

No.12 20 min

1	(399)
2	(337)
3	(001)
4	(017)
5	(405)

↓ 150.3 mm
↔ 112.8 mm

No.2 11 min

1	(027)
2	(612)
3	(070)
4	(502)
5	(019)
6	(085)
7	(206)
8	(086)
9	(001)
10	(070)

↓ 52.4 mm
↔ 63.0 mm

No.5 6 min

1	(900)
2	(800)

↓ 145.6 mm
↔ 112.0 mm



No.6 13 min

1	(124)	7	(509)	13	(613)
2	(800)	8	(613)	14	(612)
3	(001)	9	(612)	15	(613)
4	(807)	10	(206)	16	(206)
5	(348)	11	(612)		
6	(206)	12	(509)		

↓ 56.0 mm ↔ 74.8 mm

No.3 3 min

1	(812)
2	(027)
3	(515)
4	(513)

↓ 27.7 mm
↔ 56.7 mm

No.4 5 min

1	(807)
2	(515)
3	(001)
4	(017)
5	(070)

↓ 61.6 mm
↔ 76.9 mm

No.7 1 min

1	(900)
2	(800)

↓ 20.4 mm
↔ 38.0 mm



No.13

27 min		
1 (420)	11 (420)	21 (085)
2 (017)	12 (086)	22 (086)
3 (086)	13 (807)	23 (807)
4 (807)	14 (085)	24 (085)
5 (085)	15 (612)	25 (807)
6 (612)	16 (804)	26 (612)
7 (804)	17 (206)	27 (804)
8 (206)	18 (807)	28 (206)
9 (807)	19 (420)	
10 (017)	20 (017)	
↓ 105.9 mm ↔ 158.6 mm		



No.14

15 min		
1 (509)	6 (502)	11 (001)
2 (206)	7 (509)	12 (017)
3 (001)	8 (086)	13 (086)
4 (124)	9 (502)	
5 (017)	10 (509)	
↓ 68.1 mm ↔ 98.3 mm		



No.15

43 min	
1 (509)	
2 (513)	
3 (502)	
4 (079)	
5 (001)	
6 (206)	
7 (208)	
8 (513)	
9 (502)	
10 (509)	
↓ 129.4 mm ↔ 131.5 mm	

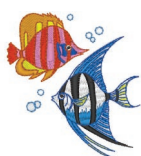

No.16

14 min	
1 (001)	
2 (019)	
3 (205)	
4 (209)	
5 (085)	
6 (030)	
7 (900)	
8 (405)	
9 (339)	
↓ 76.5 mm ↔ 69.9 mm	



No.17

2 min	
1 (800)	
2 (019)	
3 (001)	
4 (420)	
↓ 28.9 mm ↔ 18.9 mm	



No.18

13 min	
1 (030)	
2 (209)	
3 (208)	
4 (206)	
5 (202)	
6 (900)	
↓ 50.9 mm ↔ 74.5 mm	



No.19

11 min	
1 (017)	
2 (001)	
3 (405)	
↓ 56.4 mm ↔ 70.0 mm	



No.20

10 min	
1 (030)	
↓ 76.8 mm ↔ 77.6 mm	



No.21

7 min	
1 (001)	
2 (005)	
3 (405)	
4 (800)	
5 (001)	
6 (817)	
↓ 50.2 mm ↔ 50.2 mm	



No.22

5 min	
1 (001)	7 (126)
2 (017)	8 (612)
3 (502)	9 (800)
4 (086)	10 (086)
5 (202)	11 (001)
6 (019)	
↓ 63.0 mm ↔ 29.7 mm	



No.23

10 min		
1 (030)	5 (005)	9 (001)
2 (019)	6 (017)	10 (405)
3 (001)	7 (019)	11 (030)
4 (405)	8 (206)	12 (017)
↓ 48.4 mm ↔ 91.4 mm		



No.24

3 min	
1 (534)	
↓ 57.3 mm ↔ 64.8 mm	



No.25

21 min		
1 (019)	6 (086)	11 (085)
2 (515)	7 (206)	12 (086)
3 (513)	8 (019)	13 (206)
4 (209)	9 (515)	
5 (085)	10 (513)	
↓ 82.7 mm ↔ 85.3 mm		



No.26

18 min		
1 (001)	9 (001)	17 (001)
2 (323)	10 (323)	18 (323)
3 (513)	11 (513)	19 (507)
4 (507)	12 (507)	20 (513)
5 (513)	13 (513)	21 (206)
6 (206)	14 (206)	22 (208)
7 (208)	15 (208)	23 (328)
8 (328)	16 (328)	
↓ 76.3 mm ↔ 76.4 mm		



No.27

15 min	
1 (399)	
2 (534)	
3 (810)	
4 (399)	
5 (070)	
6 (614)	
7 (086)	
↓ 87.3 mm ↔ 89.2 mm	



No.28

19 min		
1 (202)	7 (202)	13 (202)
2 (406)	8 (406)	14 (406)
3 (019)	9 (019)	15 (019)
4 (513)	10 (513)	16 (513)
5 (515)	11 (515)	17 (515)
6 (519)	12 (519)	18 (519)
↓ 76.8 mm ↔ 130.5 mm		

Embroidery Pattern Color Change Table
 Stickmuster-Farbtabelle
 Tableau de changement de couleur des motifs de broderie
 Kleurwijzigingstabel voor de borduurpatronen
 Tabella di cambiamento colori degli schemi di ricamo
 Tabla de cambio de color para patrones de bordado
 Fargeoppsett broderimønstre
 Таблицы цветов нитей для вышивок



No.29

15 min		
1 (509)	5 (328)	9 (206)
2 (030)	6 (337)	10 (126)
3 (206)	7 (323)	
4 (126)	8 (017)	
↓ 73.2 mm ↔ 93.0 mm		



No.34

12 min		
1 (214)	5 (515)	9 (612)
2 (323)	6 (513)	10 (620)
3 (339)	7 (209)	11 (339)
4 (030)	8 (208)	
↓ 52.8 mm ↔ 69.3 mm		



No.40

18 min	
1 (517)	
2 (323)	
3 (214)	
4 (348)	
5 (800)	
6 (214)	
7 (330)	
8 (030)	
9 (214)	
↓ 88.9 mm ↔ 112.0 mm	



No.30

44 min		
1 (507)	7 (107)	13 (001)
2 (534)	8 (202)	14 (017)
3 (507)	9 (206)	15 (800)
4 (001)	10 (507)	16 (107)
5 (017)	11 (534)	17 (202)
6 (800)	12 (507)	18 (206)
↓ 123.2 mm ↔ 120.6 mm		



No.35

7 min		
1 (010)	5 (205)	9 (405)
2 (027)	6 (900)	10 (030)
3 (001)	7 (030)	
4 (620)	8 (339)	
↓ 60.6 mm ↔ 68.2 mm		



No.41

13 min	
1 (307)	
2 (517)	
3 (513)	
4 (515)	
5 (612)	
6 (807)	
7 (517)	
8 (812)	
↓ 74.3 mm ↔ 75.8 mm	



No.42



No.31

17 min	
1 (001)	
2 (843)	
3 (328)	
4 (323)	
5 (058)	
6 (900)	
↓ 93.1 mm ↔ 52.7 mm	



No.36

3 min	
1 (214)	
2 (800)	
3 (339)	
↓ 22.0 mm ↔ 81.2 mm	



No.37

7 min	
1 (328)	
2 (323)	
3 (415)	
4 (339)	
5 (517)	
6 (307)	
↓ 45.8 mm ↔ 53.4 mm	



No.32

25 min	
1 (205)	
2 (900)	
3 (707)	
4 (001)	
5 (707)	
6 (005)	
7 (070)	
8 (030)	
9 (900)	
↓ 77.5 mm ↔ 74.1 mm	



No.38

10 min	
1 (348)	
2 (337)	
3 (330)	
4 (517)	
5 (214)	
6 (323)	
7 (107)	
↓ 75.0 mm ↔ 76.2 mm	



No.33

3 min	
1 (058)	
2 (209)	
3 (202)	
4 (323)	
5 (513)	
6 (515)	
↓ 30.1 mm ↔ 33.0 mm	



No.39

4 min	
1 (107)	
↓ 79.2 mm ↔ 79.2 mm	

26 min		
1 (307)	8 (812)	15 (612)
2 (517)	9 (307)	16 (812)
3 (513)	10 (517)	17 (612)
4 (515)	11 (513)	18 (807)
5 (807)	12 (515)	19 (812)
6 (517)	13 (807)	
7 (612)	14 (517)	
↓ 106.6 mm ↔ 106.8 mm		



No.43

42 min		
1 (399)	12 (328)	23 (339)
2 (328)	13 (517)	24 (542)
3 (206)	14 (206)	25 (517)
4 (337)	15 (339)	26 (058)
5 (339)	16 (337)	27 (399)
6 (517)	17 (542)	28 (206)
7 (328)	18 (058)	29 (517)
8 (058)	19 (542)	30 (339)
9 (542)	20 (399)	31 (328)
10 (399)	21 (328)	32 (058)
11 (058)	22 (206)	33 (542)
↓ 148.1 mm ↔ 114.0 mm		



No.44

15 min		
1 (348)	6 (058)	11 (058)
2 (214)	7 (208)	12 (348)
3 (126)	8 (214)	13 (339)
4 (208)	9 (126)	
5 (513)	10 (348)	

↓ 55.9 mm ↔ 122.9 mm



No.45

38 min		
1 (348)	12 (348)	23 (517)
2 (214)	13 (314)	24 (348)
3 (515)	14 (214)	25 (214)
4 (214)	15 (328)	26 (515)
5 (333)	16 (323)	27 (328)
6 (517)	17 (515)	28 (323)
7 (323)	18 (214)	29 (058)
8 (058)	19 (517)	30 (214)
9 (348)	20 (323)	
10 (515)	21 (348)	
11 (517)	22 (333)	

↓ 123.4 mm ↔ 123.6 mm



No.46

20 min		
1 (800)	6 (843)	11 (079)
2 (620)	7 (307)	12 (800)
3 (124)	8 (515)	13 (620)
4 (079)	9 (339)	14 (515)
5 (001)	10 (124)	

↓ 72.4 mm ↔ 95.5 mm



No.47

12 min		
1 (406)	5 (513)	9 (086)
2 (507)	6 (612)	10 (328)
3 (513)	7 (019)	11 (800)
4 (205)	8 (001)	12 (205)

↓ 56.1 mm ↔ 71.7 mm



No.48

4 min	
1 (323)	2 (208)
3 (507)	4 (800)

↓ 49.4 mm

↔ 40.2 mm



No.49

8 min	
1 (001)	2 (017)
3 (206)	4 (807)
5 (612)	6 (515)

↓ 54.5 mm

↔ 76.3 mm



No.50

9 min	
1 (405)	2 (328)
3 (107)	

↓ 88.2 mm

↔ 92.2 mm



No.51

6 min	
1 (001)	4 (214)
2 (800)	5 (209)
3 (817)	6 (900)

↓ 60.8 mm ↔ 30.4 mm



No.52

10 min	
1 (214)	2 (800)

↓ 96.2 mm

↔ 61.3 mm



No.53

6 min	
1 (030)	

↓ 77.8 mm

↔ 75.2 mm



No.54

2 min	
1 (214)	2 (509)
3 (800)	

↓ 64.9 mm

↔ 21.2 mm



No.55

12 min	
1 (058)	2 (515)
3 (800)	4 (206)
5 (323)	6 (058)
7 (534)	

↓ 56.0 mm

↔ 89.4 mm



No.56

10 min	
1 (507)	2 (328)
3 (001)	4 (800)
5 (328)	

↓ 52.8 mm

↔ 98.5 mm



No.57

16 min	
1 (328)	2 (348)
3 (126)	4 (206)
5 (107)	6 (001)
7 (507)	8 (328)
9 (107)	

↓ 92.4 mm

↔ 90.7 mm



No.58

9 min		
1 (542)	5 (542)	9 (415)
2 (323)	6 (323)	10 (323)
3 (415)	7 (415)	11 (406)
4 (323)	8 (323)	12 (205)

↓ 91.6 mm ↔ 90.1 mm



No.59

12 min		
1 (058)	5 (001)	9 (019)
2 (307)	6 (058)	10 (030)
3 (206)	7 (507)	11 (017)
4 (019)	8 (800)	

↓ 75.1 mm ↔ 100.1 mm



No.60

22 min	
1 (399)	2 (348)
3 (507)	4 (800)
5 (348)	6 (507)
7 (800)	8 (348)

↓ 95.8 mm

↔ 102.3 mm

Embroidery Pattern Color Change Table
Stickmuster-Farbtabelle
Tableau de changement de couleur des motifs de broderie
Kleurwijzigingstabel voor de borduurpatronen
Tabella di cambiamento colori degli schemi di ricamo
Tabla de cambio de color para patrones de bordado
Fargeoppsett broderimønstre
Таблицы цветов нитей для вышивок

- "Other" designs
- « Autres » motifs
- Disegni "Vari"
- "Andre"-design

- Designs „Sonstige“
- "Andere" ontwerpen
- "Otros" diseños
- Другие рисунки

No.61 **9 min**



1	(614)
2	(620)
3	(405)
↓	82.4 mm
↔	91.2 mm

No.65 **8 min**



1	(019)
2	(017)
3	(019)
↓	69.9 mm
↔	67.1 mm

★ No.69 **4 min / 2 min**



1	(707)
↓	75.0 mm
L:	↔ 43.3 mm
↓	45.9 mm
S:	↔ 26.9 mm

No.62 **5 min**



1	(399)
2	(808)
3	(509)
↓	42.5 mm
↔	100.9 mm

★ No.66 **38 min / 19 min**



1	(843)
2	(614)
3	(517)
4	(843)
5	(517)
6	(843)
7	(517)
8	(843)
9	(614)
↓	154.1 mm
L:	↔ 118.7 mm
↓	96.6 mm
S:	↔ 73.4 mm

No.70 **8 min**



1	(519)
2	(704)
3	(800)
4	(542)
5	(519)
6	(704)
↓	84.0 mm
↔	59.7 mm

★ No.63 **8 min / 4 min**



1	(843)
2	(399)
3	(800)
↓	99.0 mm
L:	↔ 151.0 mm
↓	58.6 mm
S:	↔ 89.0 mm

No.67 **10 min**



1	(328)
2	(900)
3	(328)
4	(900)
↓	55.1 mm
↔	45.9 mm

No.71 **22 min**



1	(900)
2	(704)
3	(800)
4	(005)
5	(900)
6	(704)
↓	140.5 mm
↔	119.1 mm

No.64 **11 min**



1	(001)
2	(328)
3	(406)
4	(328)
5	(019)
↓	93.0 mm
↔	70.6 mm

No.68 **11 min**



1	(107)
↓	68.2 mm
↔	77.3 mm

No.72 **26 min**



1	(001)
2	(817)
3	(900)
4	(001)
5	(030)
↓	120.9 mm
↔	99.8 mm

Patterns marked with ★ are in large and small sizes. Make your selection prior to touching embroidery.
 Mit ★ markierte Muster gibt es in großen und kleinen Größen. Treffen Sie Ihre Auswahl, bevor Sie Stickerei berühren.
 Les motifs marqués d'une ★ sont disponibles en grande et petite tailles. Effectuez votre sélection avant d'appuyer sur broderie.
 Patronen die zijn gemarkeerd met ★ zijn beschikbaar in groot en klein formaat. Maak uw keuze voordat u de borduurtoets aanraakt.
 I disegni contrassegnati da ★ sono disponibili in dimensioni grandi e piccole. Selezionare le dimensioni desiderate prima di toccare il ricamo.
 Los patrones marcados con ★ están disponibles en tamaño grande y pequeño. Realice su selección antes de tocar el bordado.
 Mønstre merket med ★ finnes i store og små størrelser. Velg før du berører brodering.
 Рисунки, отмеченные знаком ★, имеются в большом и малом размерах. Выберите необходимый.

◆ Brother “Exclusives” Trend designs

◆ Motifs tendance Brother « exclusifs »

◆ Disegni Tendenza “Esclusivi” Brother

◆ Brother “Exclusives”-trenddesign

◆ Brother-„Exklusiv“: Modische Designs

◆ “Exclusief” trendontwerpen van Brother

◆ Diseños de tendencias “exclusivos” de Brother

◆ Brother “Эксклюзив” стильные дизайны



No.1	28 min
1	(800)
↓	276.0 mm
↔	165.8 mm



No.4	84 min	
1	(001)	17 (017)
2	(399)	18 (001)
3	(405)	19 (405)
4	(017)	20 (017)
5	(399)	21 (399)
6	(001)	22 (001)
7	(405)	23 (399)
8	(399)	24 (001)
9	(017)	25 (405)
10	(001)	26 (017)
11	(399)	27 (001)
12	(405)	28 (405)
13	(017)	29 (017)
14	(405)	30 (405)
15	(001)	31 (399)
16	(399)	32 (001)
	↓ 264.0 mm ↔ 164.4 mm	



No.2	29 min		
1	(900)	7 (328)	13 (415)
2	(534)	8 (509)	14 (507)
3	(420)	9 (208)	15 (070)
4	(509)	10 (534)	16 (206)
5	(507)	11 (515)	17 (900)
6	(415)	12 (517)	
	↓ 181.9 mm ↔ 169.4 mm		



No.5	12 min
1	(330)
↓	231.6 mm
↔	138.4 mm



No.3	39 min		
1	(206)	6 (810)	11 (086)
2	(502)	7 (607)	12 (502)
3	(607)	8 (707)	13 (707)
4	(086)	9 (206)	
5	(707)	10 (607)	
	↓ 150.3 mm ↔ 146.3 mm		

Embroidery Pattern Color Change Table
Stickmuster-Farbtabelle
Tableau de changement de couleur des motifs de broderie
Kleurwijzigingstabel voor de borduurpatronen
Tabella di cambiamento colori degli schemi di ricamo
Tabla de cambio de color para patrones de bordado
Fargeoppsett broderimønstre
Таблицы цветов нитей для вышивок

● No.6

12 min	
1	■ (900)
↕	209.6 mm
↔	92.3 mm



No.9

51 min	
1	■ (124)
2	■ (399)
3	■ (807)
4	■ (086)
5	■ (399)
6	■ (001)
7	■ (086)
8	■ (807)
9	■ (124)
10	■ (399)
11	■ (807)
12	■ (124)
13	■ (086)
14	■ (001)
15	■ (086)
16	■ (807)
17	■ (399)
18	■ (001)
19	■ (086)
20	■ (807)
21	■ (124)
22	■ (086)
23	■ (399)
24	■ (807)
25	■ (124)
26	■ (086)
↕	275.6 mm
↔	152.4 mm



No.7

5 min	
1	■ (607)
2	■ (333)
3	■ (348)
↕	29.6 mm
↔	94.0 mm

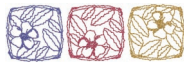

● No.8

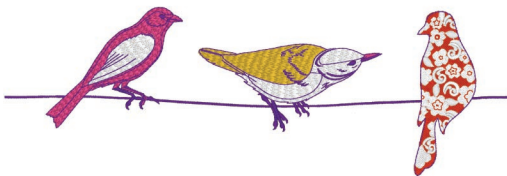

32 min	
1	■ (086)
2	■ (001)
3	■ (613)
4	■ (614)
5	■ (001)
6	■ (208)
7	■ (086)
8	■ (613)
9	■ (614)
10	■ (030)
11	■ (001)
12	■ (613)
13	■ (030)
↕	266.6 mm
↔	89.1 mm

No.10

49 min	
1	■ (001)
2	■ (420)
3	■ (406)
4	■ (542)
5	■ (399)
6	■ (420)
7	■ (001)
8	■ (420)
9	■ (406)
10	■ (542)
11	■ (399)
12	■ (542)
13	■ (399)
14	■ (406)
15	■ (420)
16	■ (399)
17	■ (406)
18	■ (542)
19	■ (420)
20	■ (406)
21	■ (542)
22	■ (406)
↕	257.0 mm
↔	173.8 mm



Patterns marked with ● have been rotated. Check your design placement prior to embroidering.

Muster, die mit ● gekennzeichnet sind, wurden gedreht. Überprüfen Sie die Platzierung Ihres Designs, bevor Sie mit Sticken beginnen.

Les motifs signalés par ● ont été pivotés. Vérifiez l'emplacement de votre motif avant de commencer à broder.

Patronen die zijn gemarkeerd met ● zijn gedraaid. Controleer de plaats van uw ontwerp voordat u gaat borduren.

I disegni contrassegnati dal simbolo ● appaiono ruotati. Prima di procedere al ricamo, verificare la posizione del disegno.

Los patrones marcados con ● se han girado. Compruebe la colocación del diseño antes de bordar.

Mønstre merket med ● har blitt rotert. Kontrollér mønsterplasseringen før du broderer.

Рисунки, отмеченные знаком ●, повернуты. Проверьте расположение рисунка перед началом вышивания.

◆ Brother “Exclusives” Vintage designs

◆ Motifs classiques Brother « exclusifs »

◆ Disegni Vintage “Esclusivi” Brother

◆ Brother “Exclusives”-vintagedesigner

◆ Brother-„Exklusiv“: Klassische Designs

◆ “Exclusief” nostalgische ontwerpen van Brother

◆ Diseños de época “exclusivos” de Brother

◆ Brother “Эксклюзив” винтажные дизайны



● No.1



68 min			
1 (348)	9 (126)	17 (348)	25 (328)
2 (333)	10 (348)	18 (333)	26 (843)
3 (328)	11 (869)	19 (328)	27 (124)
4 (843)	12 (328)	20 (843)	28 (079)
5 (124)	13 (333)	21 (124)	29 (333)
6 (079)	14 (843)	22 (348)	30 (869)
7 (333)	15 (126)	23 (869)	31 (126)
8 (869)	16 (124)	24 (333)	
↓ 272.4 mm ↔ 160.6 mm			

No.3

45 min

1	(406)
↓	285.8 mm
↔	133.8 mm



● No.2



78 min			
1 (807)	11 (517)	21 (333)	31 (843)
2 (333)	12 (333)	22 (843)	32 (019)
3 (328)	13 (328)	23 (001)	33 (517)
4 (085)	14 (843)	24 (079)	34 (328)
5 (843)	15 (807)	25 (843)	35 (807)
6 (328)	16 (517)	26 (085)	36 (328)
7 (085)	17 (079)	27 (517)	37 (085)
8 (807)	18 (328)	28 (328)	38 (843)
9 (328)	19 (001)	29 (001)	39 (085)
10 (001)	20 (517)	30 (017)	40 (328)
↓ 263.2 mm ↔ 164.2 mm			

No.4

26 min

1	(107)
2	(085)
3	(086)
4	(406)
5	(513)
6	(017)
7	(607)
8	(406)
9	(513)
10	(017)
11	(607)
12	(406)
13	(513)
14	(017)
15	(607)
16	(085)
17	(086)
18	(107)
19	(406)
20	(399)
↓	287.0 mm
↔	170.5 mm



Embroidery Pattern Color Change Table
Stickmuster-Farbtabelle
Tableau de changement de couleur des motifs de broderie
Kleurwijzigingstabel voor de borduurpatronen
Tabella di cambiamento colori degli schemi di ricamo
Tabla de cambio de color para patrones de bordado
Fargeoppsett broderimønstre
Таблицы цветов нитей для вышивок



No.5		9 min	
1	(001)	2	(348)
3	(070)	4	(001)
5	(348)	6	(070)
↓		82.0 mm	
↔		91.8 mm	



No.7		14 min	
1	(800)	2	(534)
3	(405)	4	(348)
5	(058)	↓	
		41.6 mm	
		↔	
		74.6 mm	



No.9		9 min	
1	(517)	2	(206)
3	(323)	4	(333)
↓		44.1 mm	
↔		103.0 mm	



No.6		17 min	
1	(800)	2	(534)
3	(405)	4	(800)
5	(348)	6	(058)
↓		81.2 mm	
↔		57.2 mm	



No.8		8 min	
1	(517)	2	(010)
3	(206)	4	(323)
5	(333)	↓	
		60.5 mm	
		↔	
		66.1 mm	



No.10		12 min	
1	(515)	2	(415)
3	(399)	4	(124)
5	(085)	6	(086)
7	(415)	8	(202)
↓		123.3 mm	
↔		64.0 mm	

◆ Brother “Exclusives” Japanese designs

◆ Motifs japonais Brother « exclusifs »

◆ Disegni giapponesi “Esclusivi” Brother

◆ Brothers “Exclusives” japanske designer

◆ Brother „Exklusiv“: Japanische Designs

◆ “Exklusief” Japanse ontwerpen van Brother

◆ Diseños japoneses “exclusivos” de Brother

◆ Brother “Эксклюзив” японские дизайны



● No.1



No.1		99 min			
1	(208)	14	(202)	27	(017)
2	(509)	15	(017)	28	(509)
3	(001)	16	(509)	29	(607)
4	(202)	17	(800)	30	(800)
5	(017)	18	(900)	31	(900)
6	(509)	19	(001)	32	(001)
7	(208)	20	(017)	33	(202)
8	(079)	21	(800)	34	(208)
9	(800)	22	(509)	35	(900)
10	(900)	23	(900)	36	(509)
11	(001)	24	(001)	37	(017)
12	(079)	25	(079)	38	(079)
13	(607)	26	(202)	39	(800)
				40	(900)
				41	(800)
				42	(001)
				43	(208)
				44	(607)
				45	(017)
				46	(509)
				47	(800)
				48	(001)
				49	(208)
				50	(607)
				51	(017)
				52	(509)
				↓	
				287.2 mm	
				↔	
				172.6 mm	

Patterns marked with ● have been rotated. Check your design placement prior to embroidering.

Muster, die mit ● gekennzeichnet sind, wurden gedreht. Überprüfen Sie die Platzierung Ihres Designs, bevor Sie mit Sticken beginnen.

Les motifs signalés par ● ont été pivotés. Vérifiez l'emplacement de votre motif avant de commencer à broder.

Patronen die zijn gemarkeerd met ● zijn gedraaid. Controleer de plaats van uw ontwerp voordat u gaat borduren.

I disegni contrassegnati dal simbolo ● appaiono ruotati. Prima di procedere al ricamo, verificare la posizione del disegno.

Los patrones marcados con ● se han girado. Compruebe la colocación del diseño antes de bordar.

Mønstre merket med ● har blitt rotert. Kontrollør mønsterplasseringen før du broderer.

Рисунки, отмеченные знаком ●, повернуты. Проверьте расположение рисунка перед началом вышивания.



No.2 **94 min**

1	(030)	22	(542)	43	(001)
2	(507)	23	(612)	44	(307)
3	(348)	24	(406)	45	(208)
4	(323)	25	(208)	46	(328)
5	(001)	26	(900)	47	(406)
6	(542)	27	(328)	48	(542)
7	(612)	28	(406)	49	(900)
8	(323)	29	(030)	50	(030)
9	(406)	30	(507)	51	(507)
10	(208)	31	(001)	52	(399)
11	(900)	32	(348)	53	(001)
12	(704)	33	(612)	54	(612)
13	(328)	34	(542)	55	(542)
14	(406)	35	(208)	56	(208)
15	(307)	36	(323)	57	(307)
16	(030)	37	(406)	58	(348)
17	(507)	38	(900)	59	(420)
18	(001)	39	(030)	60	(323)
19	(399)	40	(507)	61	(406)
20	(348)	41	(328)	62	(900)
21	(323)	42	(323)		

↓ 244.4 mm ↔ 123.5 mm



No.6 **9 min**

1	(415)
2	(399)
3	(323)
4	(800)
5	(005)
6	(399)
7	(328)

↓ 63.2 mm
↔ 117.0 mm



No.7 **18 min**

1	(001)	6	(030)
2	(058)	7	(209)
3	(515)	8	(001)
4	(517)	9	(399)
5	(800)	10	(208)

↓ 84.0 mm ↔ 78.2 mm



No.3 **73 min**

1	(030)	8	(214)	15	(328)
2	(515)	9	(328)	16	(810)
3	(019)	10	(030)	17	(612)
4	(328)	11	(612)	18	(030)
5	(810)	12	(206)	19	(348)
6	(206)	13	(810)	20	(206)
7	(348)	14	(348)	21	(348)

↓ 152.1 mm ↔ 151.0 mm



No.8 **18 min**

1	(328)
2	(058)
3	(515)
4	(519)
5	(330)
6	(058)
7	(337)
8	(348)
9	(079)
10	(086)
11	(058)
12	(010)

↓ 140.6 mm
↔ 62.3 mm

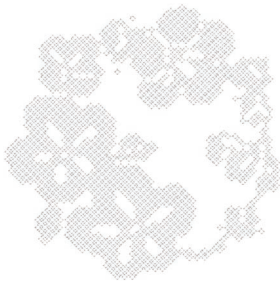

No.4 **15 min**

1	(001)
---	-------

↓ 145.1 mm
↔ 144.9 mm



No.5 **21 min**

1	(337)	8	(337)
2	(019)	9	(019)
3	(614)	10	(614)
4	(612)	11	(612)
5	(507)	12	(507)
6	(206)	13	(206)
7	(348)	14	(348)

↓ 85.8 mm ↔ 91.3 mm











No.9 **29 min**

1	(001)
2	(399)
3	(534)
4	(502)
5	(070)
6	(406)
7	(070)
8	(399)
9	(206)
10	(070)
11	(406)
12	(534)
13	(502)

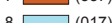

↓ 128.2 mm
↔ 139.2 mm

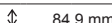
No.10 **12 min**

1		(333)
2		(607)
3		(206)
4		(399)
5		(517)
6		(612)
7		(337)
8		(017)
9		(005)
↓		84.9 mm
↔		86.4 mm





No.13 **36 min**

1		(900)
2		(030)
↓		252.6 mm
↔		152.5 mm



Taishi: Ambition
 Ambition
 Ambition
 Ambitie
 Ambizione
 Ambición
 Ambisjoner
 Мечта



No.11 **44 min**

1		(900)
2		(030)
↓		251.8 mm
↔		175.8 mm



Kizuna: Band
 Band
 Bande
 Band
 Banda
 Banda
 Bånd
 Связь

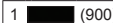

No.14 **25 min**

1		(900)
2		(030)
↓		184.7 mm
↔		104.6 mm



Seiko: Success
 Erfolg
 Succès
 Succes
 Successo
 Éxito
 Suksess
 Успех

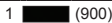

No.12 **19 min**

1		(900)
2		(030)
↓		122.4 mm
↔		142.8 mm

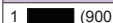

Iwai: Celebration
 Feier
 Festivités
 Feest
 Celebrazione
 Celebración
 Feiring
 Праздник

No.15 **19 min**

1		(900)
2		(030)
↓		178.0 mm
↔		93.2 mm



Sozo: Creation
 Kreation
 Création
 Schepping
 Creazione
 Creación
 Skaperverk
 Творчество

Patterns No.11 – No.15, are designed by Taisen Okamoto.
 Muster Nr.11 – Nr. 15 wurden von Taisen Okamoto entworfen.
 Les motifs 11 à 15 ont été conçus par Taisen Okamoto.
 De patronen 11 – 15 zijn ontwikkeld door Taisen Okamoto.
 I disegni dal N.11 al N. 15 sono stati realizzati da Taisen Okamoto.
 Los patrones del n° 11 al n° 15 han sido diseñados por Taisen Okamoto.
 Mønster nr. 11–15 er designet av Taisen Okamoto.
 Рисунки № 4–10 созданы Тайсен Окамото.

◆ Brother “Exclusives” Quilt designs

◆ Motifs piqués Brother « exclusifs »

◆ Disegni per trapuntatura “Esclusivi” Brother

◆ Brother “Exclusives”-quiltedesigner

◆ Brother-„Exklusiv“: Quiltedesigns

◆ “Exclusief” quiltontwerpen van Brother

◆ Diseños de acolchado “exclusivos” de Brother

◆ Brother “Эксклюзив” дизайны для квилтинга

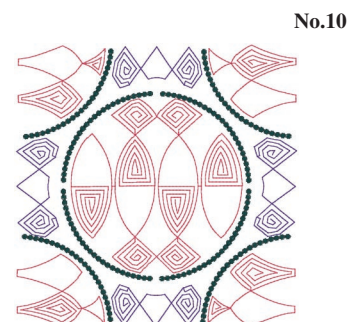
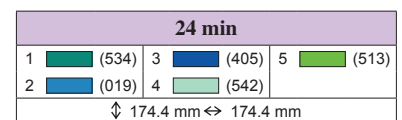
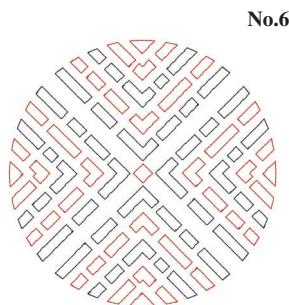
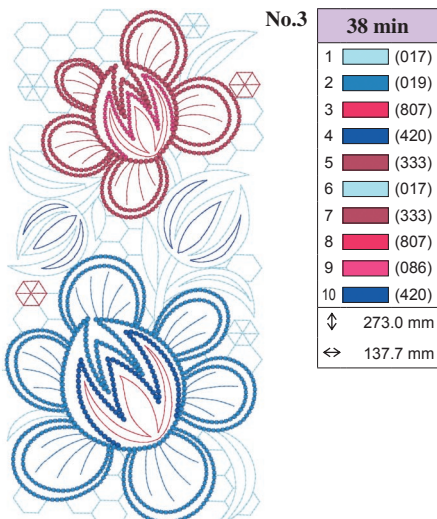
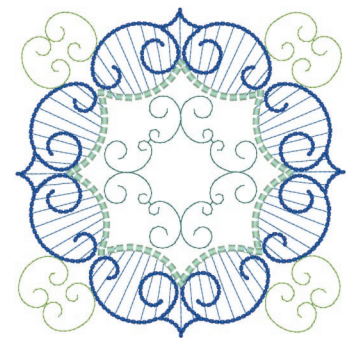
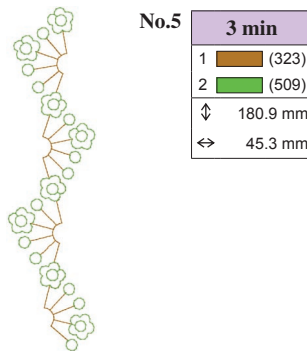
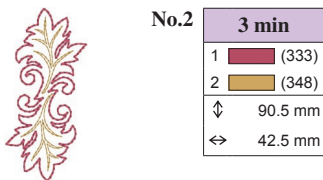
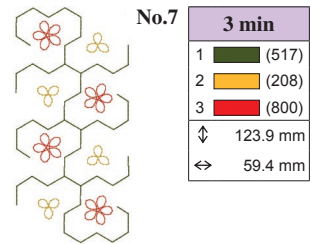
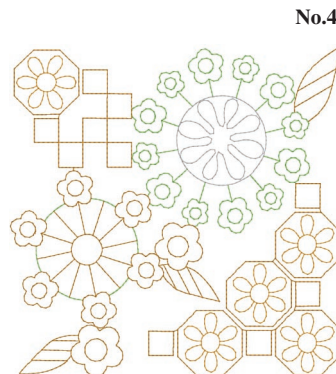
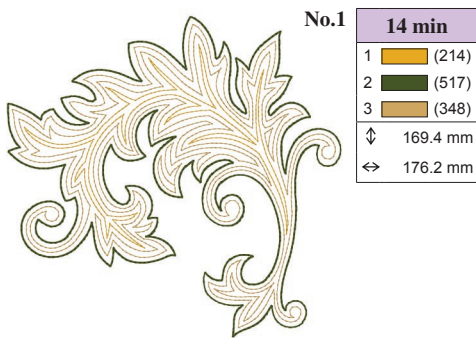

- ◆ Brother “Exclusives” New-Technique designs
- ◆ Nouveaux motifs techniques Brother « exclusifs »
- ◆ Disegni Nuova tecnica “Esclusivi” Brother
- ◆ Brother “Exclusives”-design med ny teknikk
- ◆ Brother-„Exklusiv“: Designs „Neue Technik“
- ◆ “Exclusief” ontwerpen van Brother met nieuwe technieken
- ◆ Diseños de nuevas técnicas “exclusivos” de Brother
- ◆ Brother “Эксклюзив” дизайны в новой технике



No.1

12 min	
1	(070)
2	(348)
↓	78.2 mm
↔	120.8 mm



No.2

12 min	
1	(070)
2	(348)
↓	64.4 mm
↔	145.3 mm



No.3

21 min	
1	(328)
2	(337)
3	(519)
4	(515)
5	(001)
6	(005)
↓	70.5 mm
↔	107.2 mm



No.4

49 min	
1	(808)
2	(812)
3	(513)
↓	226.6 mm
↔	109.8 mm

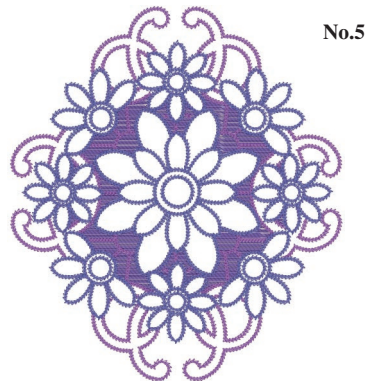

103 min

1	(614)	2	(612)	3	(607)
↓ 197.5 mm ↔ 175.1 mm					



No.6

21 min	
1	(010)
↓	70.4 mm
↔	78.8 mm

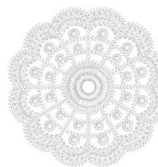

No.7

48 min	
1	(001)
↓	83.7 mm
↔	83.5 mm

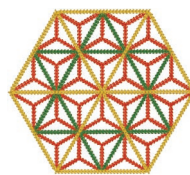

No.8

40 min	
1	(030)
2	(515)
3	(208)
↓	85.9 mm
↔	98.9 mm



No.9

9 min	
1	(019)
↓	17.3 mm
↔	96.0 mm



No.10

17 min	
1	(800)
↓	33.2 mm
↔	114.5 mm



No.11

11 min	
1	(208)
↓	32.9 mm
↔	93.6 mm



No.12

39 min	
1	(328)
2	(399)
↓	107.4 mm
↔	112.6 mm

Embroidering on water-soluble sheets without any fabric

Sticken auf wasserlöslicher Folie ohne Stoff

Broderie sur des feuilles hydrosolubles sans aucun tissu

Borduren op wateroplosbaar papier zonder textiel

Ricamo su pellicole solubili in acqua senza alcun tessuto

Bordado en láminas solubles en agua sin ninguna tela

Brodering på vannløselige ark uten stoff

Вышивание на водорастворимых листах без материала

Refer to “3D combination motifs” on page 62 for detailed instruction.

Ausführliche Hinweise, siehe „3D-Kombinationsmotive“ auf Seite 62.

Reportez-vous à la section « Motifs de combinaison 3D » à la page 62 pour des instructions détaillées.

Uitvoering aanwijzingen vindt u in “3D-combinatiemotieven” op p. 62.

Fare riferimento a “Motivi tridimensionali combinati” a pagina 62 per istruzioni dettagliate.

Consulte las instrucciones detalladas acerca de los “Motivos de combinación 3D” en la página 62.

Se “Kombinasjonsmotiv i 3D” på side 62 for en mer detaljert beskrivelse.

Подробные инструкции см. в разделе “Комбинированные 3D вышивки” на с. 62.

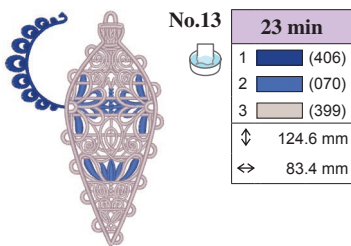

No.13		23 min
1	(406)	
2	(070)	
3	(399)	
↓	124.6 mm	
↔	83.4 mm	



No.14		14 min
1	(070)	
2	(399)	
↓	98.9 mm	
↔	39.3 mm	

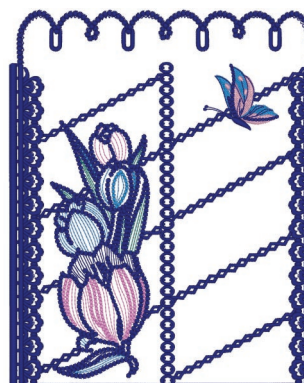

No.15		60 min
1	(019)	
2	(810)	
3	(534)	
4	(007)	
5	(019)	
6	(079)	
7	(007)	
↓	200.4 mm	
↔	161.7 mm	

Embroidering on water-soluble sheets without any fabric
 Sticken auf wasserlöslicher Folie ohne Stoff
 Broderie sur des feuilles hydrosolubles sans aucun tissu
 Borduren op wateroplosbaar papier zonder textiel
 Ricamo su pellicole solubili in acqua senza alcun tessuto
 Bordado en láminas solubles en agua sin ninguna tela
 Brodering på vannløselige ark uten stoff
 Вышивание на водорастворимых листах без материала

Recommended for embroidering on thin fabric such as organza
 Empfohlen zum Sticken auf dünnem Stoff wie Organza
 Recommandé pour la broderie sur des tissus minces comme l'organza
 Aanbevolen voor borduurwerk op dun materiaal zoals organza
 Raccomandata per ricamo su tessuto sottile quale l'organza
 Recomendado para bordar en tela fina como organza
 Anbefales ved brodering på tynne stoffer som organza
 Рекомендуется для вышивания на тонких тканях (органза и т. п.)

Refer to "3D combination motifs" on page 62 for detailed instruction.
 Ausführliche Hinweise, siehe „3D-Kombinationsmotive“ auf Seite 62.
 Reportez-vous à la section « Motifs de combinaison 3D » à la page 62 pour des instructions détaillées.
 Uitvoering aanwijzingen vindt u in "3D-combinatiemotieven" op p. 62.
 Fare riferimento a "Motivi tridimensionali combinati" a pagina 62 per istruzioni dettagliate.
 Consulte las instrucciones detalladas acerca de los "Motivos de combinación 3D" en la página 62.
 Se "Kombinasjonsmotiv i 3D" på side 62 for en mer detaljert beskrivelse.
 Подробные инструкции см. в разделе "Комбинированные 3D вышивки" на с. 62.

◆ Brother "Exclusives" Zündt designs

◆ Motifs Zündt Design Brother « exclusifs »

◆ Disegni Zündt "Esclusivi" Brother

◆ Brother "Exclusives" Zündt-design

◆ Brother-„Exklusiv“: Zündt-Designs

◆ "Exclusief" Zündt-ontwerpen van Brother

◆ Diseños Zündt "exclusivos" de Brother

◆ Brother "Эксклюзив" дизайны Zündt



No.1		57 min
1	(214)	
2	(206)	
3	(126)	
4	(800)	
5	(206)	
6	(126)	
7	(800)	
8	(086)	
9	(214)	
↓	250.8 mm	
↔	170.8 mm	



No.2		20 min
1	(206)	(206)
2	(126)	(126)
3	(800)	(800)
4	(086)	(086)
5	(214)	(214)
↓	180.0 mm	↔ 84.8 mm



No.3		11 min
1	(214)	
↓	258.4 mm	
↔	175.6 mm	



No.4		4 min
1	(214)	
↓	175.8 mm	
↔	83.8 mm	

Embroidery Pattern Color Change Table
Stickmuster-Farbtabelle
Tableau de changement de couleur des motifs de broderie
Kleurwijzigingstabel voor de borduurpatronen
Tabella di cambiamento colori degli schemi di ricamo
Tabla de cambio de color para patrones de bordado
Fargeoppsett broderimønstre
Таблицы цветов нитей для вышивок

No.5 **36 min**



1	(085)
2	(010)
3	(027)
4	(620)
5	(010)
6	(027)

↓ 175.6 mm
 ↔ 141.8 mm

No.6 **26 min**



1	(085)
2	(620)
3	(513)
4	(027)

↓ 184.6 mm
 ↔ 142.0 mm

No.7 **5 min**

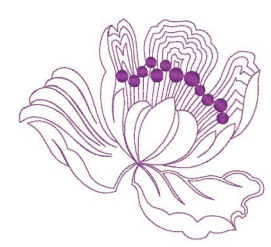

1	(620)
---	-------

↓ 116.4 mm
 ↔ 129.0 mm

No.8 **2 min**

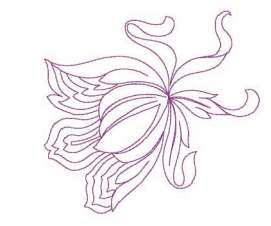

1	(620)
---	-------

↓ 106.8 mm
 ↔ 113.4 mm

No.9



1	(070)	5	(126)
2	(328)	6	(010)
3	(513)	7	(323)
4	(612)		

↓ 175.0 mm ↔ 157.4 mm

No.10



32 min	
1	(085)
2	(614)
3	(502)
4	(810)
5	(206)
6	(209)
7	(810)
8	(085)
9	(214)
10	(323)

↓ 214.0 mm ↔ 95.6 mm

No.11 **17 min**

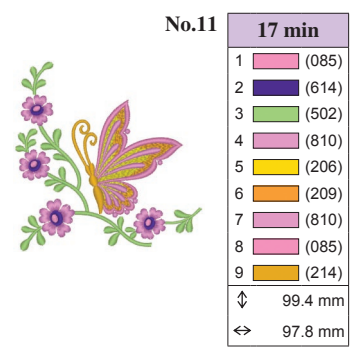

1	(085)
2	(614)
3	(502)
4	(810)
5	(206)
6	(209)
7	(810)
8	(085)
9	(214)

↓ 99.4 mm
 ↔ 97.8 mm

No.12 **3 min**

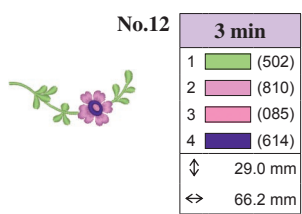

1	(502)
2	(810)
3	(085)
4	(614)

↓ 29.0 mm
 ↔ 66.2 mm

No.13



45 min	
1	(085)
2	(079)
3	(348)
4	(085)
5	(515)
6	(010)
7	(027)
8	(206)
9	(214)

↓ 163.8 mm ↔ 163.8 mm

No.14 **49 min**

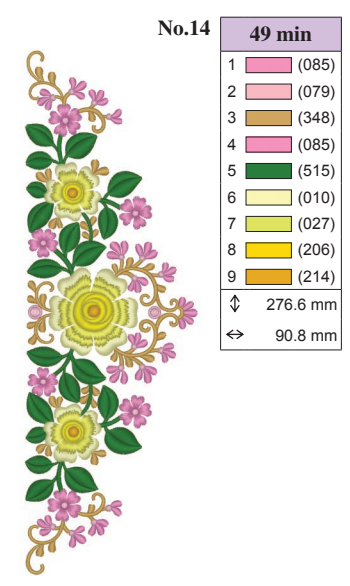

1	(085)
2	(079)
3	(348)
4	(085)
5	(515)
6	(010)
7	(027)
8	(206)
9	(214)

↓ 276.6 mm
 ↔ 90.8 mm

No.15 **20 min**

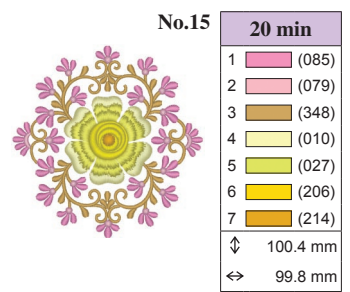

1	(085)
2	(079)
3	(348)
4	(010)
5	(027)
6	(206)
7	(214)

↓ 100.4 mm
 ↔ 99.8 mm

Patterns No.1 - No.15, are designed by Zündt Design, Ltd.
 Muster Nr. 1 - Nr. 15 wurden entworfen von Zündt Design, Ltd.
 Les motifs n° 1 à 15 ont été créés par Zündt Design, Ltd.
 De patronen 1 - 15 zijn ontwikkeld door Zündt Design, Ltd.
 I disegni dal N.1 al N.15 sono stati realizzati da Zündt Design, Ltd.
 Los patrones del N° 1 - N° 15, han sido diseñados por Zündt Design, Ltd.
 Mønstre nr. 1-15 er designet av Zündt Design, Ltd.
 Рисунки с № 1 по № 15 созданы дизайнерами компании Zündt Design, Ltd.

◆ Brother “Exclusives” Variety designs

◆ Motifs variété Brother « exclusifs »

◆ Assortimento di disegni “Esclusivi” Brother

◆ Brothers “eksklusive” variantdesign

◆ Brother „Exklusiv“ - Verschiedene Designs

◆ “Exclusieve” gevarieerde ontwerpen van Brother

◆ Diseños de variedades “exclusivos” de Brother

◆ Разнообразные “экслюзивные” дизайны от Brother



No. 1 **2 min**

1	(124)
2	(502)
3	(124)
4	(079)
5	(812)
↓	29.0 mm
↔	34.9 mm



No. 7 **9 min**

1	(513)
2	(214)
3	(001)
4	(607)
↓	58.5 mm
↔	57.5 mm



No. 13 **7 min**

1	(513)
2	(843)
3	(001)
4	(206)
5	(126)
↓	51.4 mm
↔	68.8 mm



No. 19 **5 min**

1	(001)
2	(208)
3	(405)
4	(800)
5	(019)
6	(005)
7	(900)
↓	33.6 mm
↔	32.2 mm



No. 2 **3 min**

1	(800)
2	(812)
3	(208)
4	(519)
↓	28.7 mm
↔	43.3 mm



No. 8 **6 min**

1	(348)
2	(515)
3	(513)
4	(810)
5	(323)
6	(620)
7	(812)
↓	72.3 mm
↔	90.1 mm



No. 14 **3 min**

1	(800)
2	(001)
3	(900)
4	(208)
5	(030)
↓	25.0 mm
↔	36.8 mm



No. 20 **2 min**

1	(333)
2	(800)
3	(001)
4	(900)
5	(800)
↓	26.5 mm
↔	21.9 mm



No. 3 **3 min**

1	(333)
2	(517)
3	(800)
↓	43.2 mm
↔	42.0 mm



No. 9 **13 min**

1	(509)
2	(027)
3	(085)
4	(086)
5	(807)
6	(810)
↓	63.7 mm
↔	78.5 mm



No. 15 **3 min**

1	(001)
2	(900)
3	(307)
4	(800)
5	(208)
6	(900)
↓	27.9 mm
↔	45.5 mm



No. 21 **4 min**

1	(001)
2	(206)
3	(612)
4	(030)
5	(019)
6	(415)
↓	29.3 mm
↔	29.1 mm



No. 4 **3 min**

1	(515)
2	(607)
3	(307)
4	(812)
↓	43.1 mm
↔	33.6 mm



No. 10 **5 min**

1	(509)
2	(124)
3	(612)
4	(843)
↓	77.7 mm
↔	44.9 mm



No. 16 **1 min**

1	(612)
2	(614)
↓	25.1 mm
↔	39.4 mm



No. 22 **4 min**

1	(208)
2	(001)
3	(405)
4	(800)
5	(208)
6	(001)
7	(900)
↓	35.2 mm
↔	37.5 mm



No. 5 **4 min**

1	(307)
2	(509)
3	(812)
4	(079)
5	(810)
6	(307)
↓	35.7 mm
↔	43.3 mm



No. 11 **5 min**

1	(001)
2	(070)
3	(810)
4	(812)
5	(502)
6	(001)
↓	39.7 mm
↔	44.9 mm



No. 17 **3 min**

1	(515)
2	(399)
3	(208)
4	(205)
5	(807)
↓	27.3 mm
↔	51.1 mm



No. 23 **5 min**

1	(001)
2	(208)
3	(124)
4	(086)
5	(513)
6	(900)
7	(001)
8	(019)
↓	35.5 mm
↔	32.4 mm



No. 6 **3 min**

1	(515)
2	(126)
3	(206)
4	(126)
↓	30.9 mm
↔	42.4 mm



No. 12 **4 min**

1	(513)
2	(027)
3	(612)
4	(614)
↓	44.1 mm
↔	54.8 mm



No. 18 **5 min**

1	(085)
2	(124)
3	(030)
4	(086)
5	(070)
6	(208)
↓	34.5 mm
↔	38.4 mm



Embroidery Pattern Color Change Table
Stickmuster-Farbtabelle
Tableau de changement de couleur des motifs de broderie
Kleurwijzigingstabel voor de borduurpatronen
Tabella di cambiamento colori degli schemi di ricamo
Tabla de cambio de color para patrones de bordado
Fargeoppsett broderimønstre
Таблицы цветов нитей для вышивок

No. 24 **4 min**

1	(001)
2	(800)
3	(900)
4	(205)
5	(209)
6	(005)
↕	36.9 mm
↔	30.3 mm



No. 30 **6 min**

1	(800)
2	(900)
3	(001)
↕	53.7 mm
↔	35.3 mm



No. 35 **17 min**

1	(017)
2	(019)
3	(513)
4	(812)
5	(017)
6	(612)
7	(085)
8	(017)
9	(019)
10	(513)
11	(812)
12	(017)
13	(612)
14	(085)
15	(513)
16	(017)
17	(019)
18	(812)
19	(017)
20	(085)
21	(612)
↕	132.8 mm
↔	125.4 mm



No. 25 **10 min**

1	(086)
2	(348)
3	(079)
4	(607)
↕	60.7 mm
↔	60.8 mm



No. 31 **22 min**

1	(208)
2	(800)
3	(513)
4	(620)
5	(843)
6	(509)
7	(810)
8	(205)
9	(800)
10	(515)
11	(620)
12	(800)
↕	82.7 mm
↔	92.1 mm



No. 26 **15 min**

1	(348)
2	(900)
3	(323)
4	(800)
↕	63.0 mm
↔	87.1 mm



No. 27 **12 min**

1	(502)
2	(124)
3	(307)
4	(010)
5	(348)
↕	70.1 mm
↔	77.0 mm



No. 32 **18 min**

1	(507)
2	(515)
3	(001)
4	(810)
5	(107)
6	(513)
↕	95.9 mm
↔	81.6 mm



No. 36 **26 min**

1	(517)
2	(019)
3	(007)
4	(405)
5	(007)
6	(019)
7	(214)
8	(517)
9	(019)
10	(405)
11	(007)
12	(214)
↕	191.4 mm
↔	151.9 mm

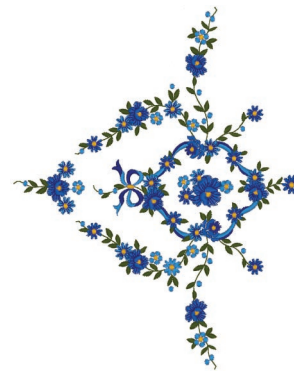

No. 28 **15 min**

1	(001)
2	(807)
3	(208)
4	(001)
5	(900)
6	(017)
7	(614)
8	(843)
9	(208)
10	(614)
11	(612)
12	(017)
13	(001)
14	(807)
↕	92.6 mm
↔	46.7 mm



No. 33 **14 min**

1	(515)
2	(058)
3	(208)
4	(209)
5	(323)
6	(058)
7	(010)
8	(405)
9	(058)
↕	67.4 mm
↔	66.7 mm



No. 37 **23 min**

1	(005)
2	(517)
3	(843)
4	(348)
5	(323)
6	(079)
7	(707)
8	(817)
9	(707)
10	(005)
11	(817)
12	(079)
↕	134.4 mm
↔	92.9 mm



No. 29 **12 min**

1	(001)
2	(030)
3	(515)
4	(206)
5	(017)
6	(085)
7	(900)
8	(030)
↕	82.4 mm
↔	90.7 mm



No. 34 **9 min**

1	(810)
2	(205)
3	(502)
4	(017)
5	(612)
↕	75.8 mm
↔	81.0 mm



No. 38 **30 min**



1	Blue	(420)
2	Pink	(079)
3	Light Blue	(017)
4	Yellow	(027)
5	Light Grey	(399)
6	Dark Blue	(420)
7	Pink	(079)
8	Dark Blue	(420)
9	Yellow	(027)
10	Light Blue	(017)
11	Light Grey	(399)
12	Dark Blue	(420)
13	Pink	(079)
14	Yellow	(027)
15	Light Blue	(017)
16	Light Grey	(399)
17	Dark Blue	(420)
18	White	(001)
19	Yellow	(027)
20	Dark Blue	(420)

↓ 290.6 mm
↔ 65.3 mm

No. 40 **27 min**



1	Gold	(348)
2	Orange	(209)
3	Brown	(323)
4	Yellow	(206)
5	Orange	(209)
6	Gold	(348)
7	Brown	(323)
8	Orange	(209)
9	Gold	(348)
10	Orange	(209)
11	Brown	(323)
12	Yellow	(206)
13	Orange	(209)

↓ 295.7 mm
↔ 94.8 mm

No. 43 **9 min**

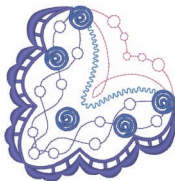

1	Blue	(607)
2	Light Blue	(019)
3	Pink	(810)
4	Dark Blue	(070)

↓ 92.8 mm
↔ 90.6 mm

No. 39 **26 min**



1	Light Blue	(017)
2	Dark Blue	(420)
3	Yellow	(027)
4	Pink	(079)
5	Light Grey	(399)
6	Light Blue	(017)
7	Dark Blue	(420)
8	Yellow	(027)
9	Pink	(079)
10	Light Grey	(399)
11	Light Blue	(017)
12	Dark Blue	(420)
13	Yellow	(027)
14	Pink	(079)
15	Light Grey	(399)
16	Dark Blue	(420)
17	White	(001)
18	Yellow	(027)
19	Dark Blue	(420)
20	Light Blue	(017)
21	Dark Blue	(420)
22	Pink	(079)
23	Yellow	(027)
24	Light Grey	(399)

↓ 174.0 mm
↔ 99.4 mm

No. 41 **17 min**



1	Gold	(348)
2	Orange	(209)
3	Brown	(323)
4	Orange	(209)
5	Yellow	(206)
6	Gold	(348)
7	Brown	(323)
8	Orange	(209)

↓ 175.3 mm
↔ 95.3 mm

No. 44 **55 min**



1	Green	(509)
2	Pink	(810)
3	Dark Green	(515)
4	Teal	(534)
5	Pink	(086)
6	Pink	(085)
7	Teal	(534)
8	Green	(509)
9	Dark Purple	(614)
10	Purple	(612)
11	Yellow	(202)
12	Pink	(085)
13	Pink	(807)
14	Purple	(612)
15	Pink	(085)
16	Pink	(086)
17	Pink	(807)
18	Teal	(534)
19	Green	(509)
20	Dark Green	(515)
21	Teal	(534)
22	Yellow	(202)
23	Pink	(807)
24	Dark Purple	(614)
25	Pink	(807)
26	Pink	(085)
27	Purple	(612)
28	Dark Purple	(614)
29	Yellow	(202)
30	Pink	(807)

↓ 291.8 mm
↔ 89.6 mm

No. 42 **19 min**

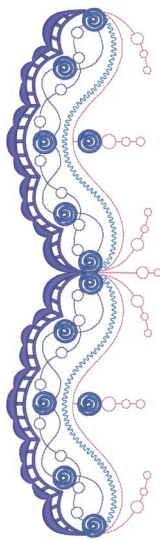

1	Blue	(607)
2	Light Blue	(019)
3	Pink	(810)
4	Dark Blue	(070)

↓ 279.8 mm
↔ 81.8 mm

No. 45 **21 min**



1	Gold	(348)
2	Gold	(348)
3	Gold	(348)
4	Gold	(348)
5	Brown	(323)
6	Green	(513)
7	Orange	(126)
8	Orange	(209)
9	Red	(030)
10	Yellow	(206)

↓ 67.4 mm
↔ 143.9 mm

Embroidery Pattern Color Change Table
Stickmuster-Farbtabelle
Tableau de changement de couleur des motifs de broderie
Kleurwijzigingstabel voor de borduurpatronen
Tabella di cambiamento colori degli schemi di ricamo
Tabla de cambio de color para patrones de bordado
Fargeoppsett broderimønstre
Таблицы цветов нитей для вышивок

No. 46 **77 min**



1	(348)
2	(330)
3	(348)
4	(330)
5	(206)
6	(126)
7	(330)
8	(126)
9	(348)
10	(330)
11	(812)
12	(206)
13	(126)
14	(330)
15	(126)
16	(348)
17	(330)
18	(812)
19	(206)
20	(126)
21	(330)
22	(206)
23	(330)
24	(126)

↓ 284.0 mm
↔ 95.3 mm

No. 47 **14 min**



1	(405)
2	(348)
3	(107)
4	(058)
5	(517)
6	(405)
7	(107)
8	(328)
9	(307)
10	(348)
11	(058)
12	(405)

↓ 96.8 mm
↔ 81.2 mm

No. 48 **31 min**



1	(405)
2	(348)
3	(107)
4	(058)
5	(517)
6	(405)
7	(107)
8	(328)
9	(348)
10	(307)
11	(348)
12	(058)
13	(405)

↓ 173.6 mm
↔ 96.8 mm

No. 49 **9 min**



1	(843)
---	-------

↓ 103.9 mm
↔ 79.8 mm

No. 50 **9 min**



1	(513)
2	(206)
3	(001)
4	(085)
5	(107)
6	(206)
7	(513)

↓ 109.5 mm
↔ 94.4 mm

No. 51 **18 min**



1	(513)
2	(001)
3	(085)
4	(206)
5	(086)
6	(107)
7	(206)
8	(513)
9	(085)
10	(206)
11	(107)
12	(513)
13	(206)

↓ 267.0 mm
↔ 93.1 mm

No. 52 **10 min**



1	(017)
2	(007)
3	(085)
4	(086)
5	(107)
6	(086)
7	(107)

↓ 136.2 mm
↔ 64.9 mm

No. 53 **7 min**



1	(007)
2	(019)
3	(007)
4	(399)
5	(005)
6	(070)

↓ 71.9 mm
↔ 92.2 mm

No. 54 **6 min**



1	(323)
2	(079)
3	(348)
4	(517)
5	(348)
6	(079)
7	(323)

↓ 93.3 mm
↔ 58.6 mm

No. 55 **5 min**



1	(005)
2	(612)

↓ 269.0 mm
↔ 77.8 mm

No. 56 **4 min**



1	(405)
2	(807)
3	(405)
4	(807)

↓ 57.3 mm
↔ 37.0 mm

No. 57 **8 min**



1	(405)
2	(807)
3	(405)
4	(807)

↓ 114.2 mm
↔ 37.0 mm

No. 58 **10 min**



1	(005)
2	(607)
3	(804)
4	(070)
5	(019)

↓ 95.4 mm
↔ 80.2 mm

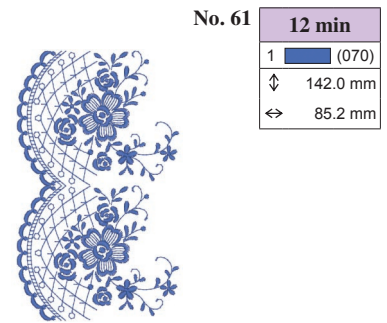
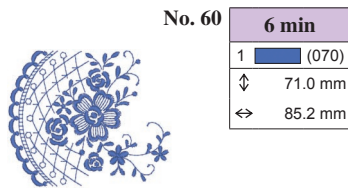
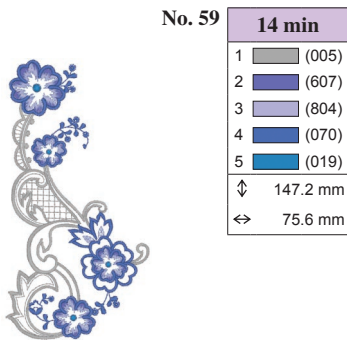

◆ Brother “Exclusives” Monogram designs

◆ Motifs monogrammes Brother « exclusifs »

◆ Disegni di monogrammi “Esclusivi” Brother

◆ Brothers “eksklusive” navnetrekdesign

◆ Brother „Exklusiv“ - Monogramm-Designs

◆ “Exclusieve” monogramontwerpen van Brother

◆ Diseños de monogramas “exclusivos” de Brother

◆ “Эксклюзивные” дизайны монограмм от Brother

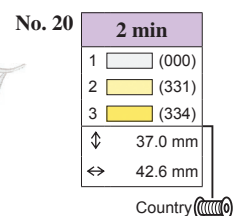
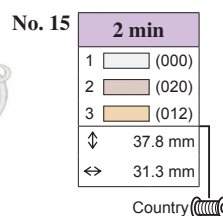
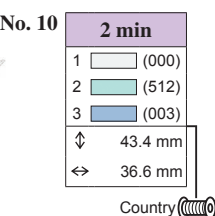
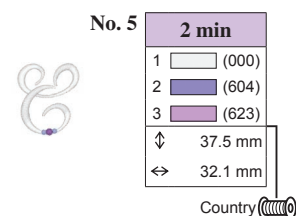
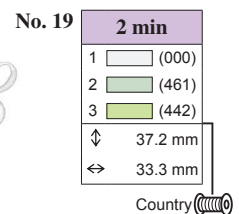
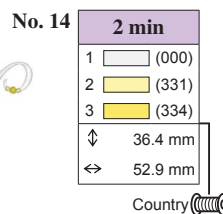
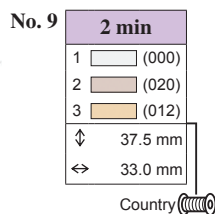
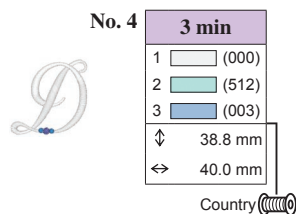
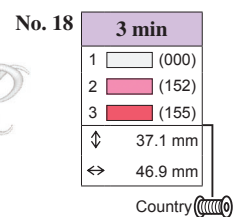
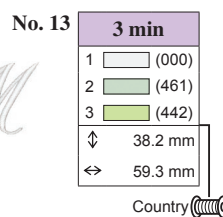
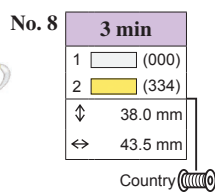
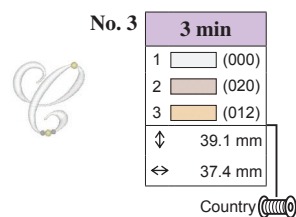
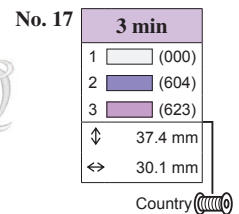
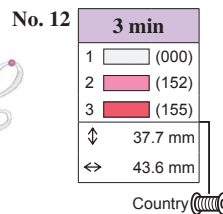
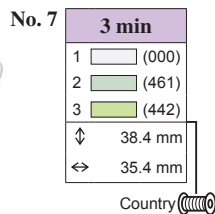
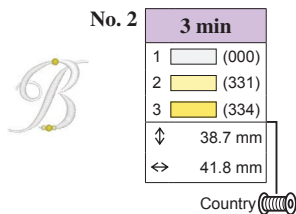
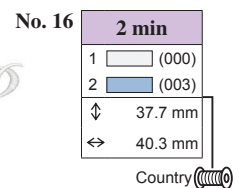
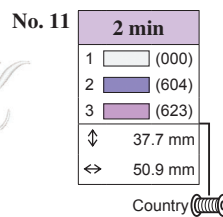
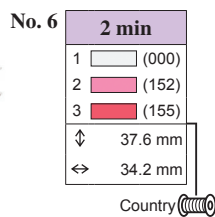
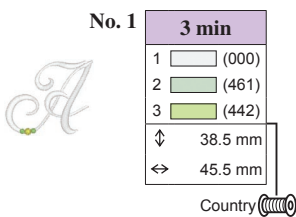

Embroidery Pattern Color Change Table
Stickmuster-Farbtabelle
Tableau de changement de couleur des motifs de broderie
Kleurwijzigingstabel voor de borduurpatronen
Tabella di cambiamento colori degli schemi di ricamo
Tabla de cambio de color para patrones de bordado
Fargeoppsett broderimønstre
Таблицы цветов нитей для вышивок

No. 21

2 min	
1	(000)
2	(012)
3	(020)
↕	38.2 mm
↔	40.7 mm

Country 



No. 27

13 min	
1	(000)
2	(370)
3	(335)
↕	87.4 mm
↔	124.4 mm

Country 



No. 22

2 min	
1	(000)
2	(512)
3	(003)
↕	38.2 mm
↔	46.9 mm

Country 



No. 28

16 min	
1	(000)
2	(003)
3	(604)
↕	107.6 mm
↔	127.7 mm

Country 



No. 23

3 min	
1	(000)
2	(512)
3	(623)
↕	37.4 mm
↔	49.6 mm

Country 



No. 29

13 min	
1	(000)
2	(623)
3	(604)
↕	104.4 mm
↔	123.2 mm

Country 



No. 24

3 min	
1	(000)
2	(152)
3	(155)
↕	38.9 mm
↔	52.6 mm

Country 



No. 30

13 min	
1	(000)
2	(442)
3	(025)
↕	88.9 mm
↔	119.3 mm

Country 



No. 26

2 min	
1	(000)
2	(334)
3	(331)
↕	37.6 mm
↔	36.7 mm

Country 



Patterns No.1 - No.30, are designed by Yuki Pallis.
 Muster Nr. 1 – Nr. 30 wurden von Yuki Pallis entworfen.
 Les motifs 1 à 30 ont été conçus par Yuki Pallis.
 De patronen 1 – 30 zijn ontwikkeld door Yuki Pallis.
 I disegni dal N. 1 al N. 30 sono stati realizzati da Yuki Pallis.
 Los patrones del n° 1 al n° 30 han sido diseñados por Yuki Pallis.
 Mønster nr.1–30 er designet av Yuki Pallis.
 Рисунки № 1–30 созданы Юки Паллис.

◆ Floral alphabet patterns

◆ Motifs alphabet floral

◆ Alfabeto floreal

◆ Blomsteralfabet

◆ Blumenalphabet

◆ Bloemletterpatronen

◆ Patrones alfabéticas en motivo floral

◆ Цветочные шрифты



No.1

24 min	
1	(328)
2	(804)
3	(612)
4	(079)
5	(807)
6	(513)
7	(502)
↓	145.1 mm
↔	125.7 mm



No.6

22 min	
1	(328)
2	(804)
3	(612)
4	(079)
5	(807)
6	(513)
7	(502)
↓	142.8 mm
↔	101.8 mm

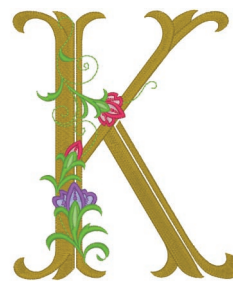

No.11

27 min	
1	(328)
2	(804)
3	(612)
4	(079)
5	(807)
6	(513)
7	(502)
↓	142.0 mm
↔	119.6 mm



No.2

27 min	
1	(328)
2	(804)
3	(612)
4	(079)
5	(807)
6	(513)
7	(502)
↓	140.9 mm
↔	108.1 mm



No.7

26 min	
1	(328)
2	(804)
3	(612)
4	(079)
5	(807)
6	(513)
7	(502)
↓	141.6 mm
↔	117.3 mm



No.12

20 min	
1	(328)
2	(804)
3	(612)
4	(079)
5	(807)
6	(513)
7	(502)
↓	144.9 mm
↔	107.0 mm



No.3

22 min	
1	(328)
2	(804)
3	(612)
4	(079)
5	(807)
6	(513)
7	(502)
↓	141.8 mm
↔	114.5 mm



No.8

30 min	
1	(328)
2	(804)
3	(612)
4	(079)
5	(807)
6	(513)
7	(502)
↓	141.7 mm
↔	121.6 mm



No.13

32 min	
1	(328)
2	(804)
3	(612)
4	(079)
5	(807)
6	(513)
7	(502)
↓	146.5 mm
↔	124.6 mm



No.4

26 min	
1	(328)
2	(804)
3	(612)
4	(079)
5	(807)
6	(513)
7	(502)
↓	141.2 mm
↔	108.3 mm



No.9

19 min	
1	(328)
2	(804)
3	(612)
4	(079)
5	(807)
6	(513)
7	(502)
↓	145.8 mm
↔	49.7 mm



No.14

27 min	
1	(328)
2	(804)
3	(612)
4	(079)
5	(807)
6	(513)
7	(502)
↓	147.0 mm
↔	116.8 mm



No.5

25 min	
1	(328)
2	(804)
3	(612)
4	(079)
5	(807)
6	(513)
7	(502)
↓	144.3 mm
↔	102.5 mm



No.10

20 min	
1	(328)
2	(804)
3	(612)
4	(079)
5	(807)
6	(513)
7	(502)
↓	144.5 mm
↔	82.3 mm



No.15

25 min	
1	(328)
2	(804)
3	(612)
4	(079)
5	(807)
6	(513)
7	(502)
↓	146.3 mm
↔	115.3 mm

Embroidery Pattern Color Change Table
Stickmuster-Farbtabelle
Tableau de changement de couleur des motifs de broderie
Kleurwijzigingstabel voor de borduurpatronen
Tabella di cambiamento colori dei schemi di ricamo
Tabla de cambio de color para patrones de bordado
Fargeoppsett broderimønstre
Таблицы цветов нитей для вышивок

No.16 **23 min**



1	(328)
2	(804)
3	(612)
4	(079)
5	(807)
6	(513)
7	(502)

↓ 143.4 mm
↔ 99.6 mm

No.20 **24 min**



1	(328)
2	(804)
3	(612)
4	(079)
5	(807)
6	(513)
7	(502)

↓ 144.5 mm
↔ 118.4 mm

No.24 **25 min**



1	(328)
2	(804)
3	(612)
4	(079)
5	(807)
6	(513)
7	(502)

↓ 142.3 mm
↔ 115.9 mm

No.17 **27 min**



1	(328)
2	(804)
3	(612)
4	(079)
5	(807)
6	(513)
7	(502)

↓ 142.7 mm
↔ 118.2 mm

No.21 **24 min**

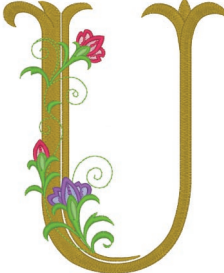

1	(328)
2	(804)
3	(612)
4	(079)
5	(807)
6	(513)
7	(502)

↓ 144.6 mm
↔ 118.5 mm

No.25 **22 min**



1	(328)
2	(804)
3	(612)
4	(079)
5	(807)
6	(513)
7	(502)

↓ 142.8 mm
↔ 116.3 mm

No.18 **28 min**



1	(328)
2	(804)
3	(612)
4	(079)
5	(807)
6	(513)
7	(502)

↓ 143.4 mm
↔ 112.5 mm

No.22 **24 min**

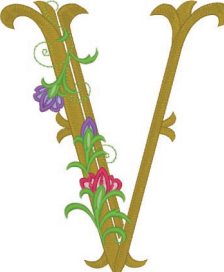

1	(328)
2	(804)
3	(612)
4	(079)
5	(807)
6	(513)
7	(502)

↓ 145.5 mm
↔ 121.5 mm

No.26 **26 min**



1	(328)
2	(804)
3	(612)
4	(079)
5	(807)
6	(513)
7	(502)

↓ 142.8 mm
↔ 92.9 mm

No.19 **28 min**



1	(328)
2	(804)
3	(612)
4	(079)
5	(807)
6	(513)
7	(502)

↓ 144.1 mm
↔ 99.4 mm

No.23 **32 min**



1	(328)
2	(804)
3	(612)
4	(079)
5	(807)
6	(513)
7	(502)

↓ 146.2 mm
↔ 124.8 mm

◆Example ◆Beispiel ◆Exemple ◆Voorbeeld
 ◆Eempio ◆Ejemplo ◆Eksempel ◆Пример

No.27 **4 min**



1	(328)
2	(079)
3	(807)
4	(513)
5	(502)

↓ 51.9 mm
↔ 45.9 mm

No.28 **4 min**



1	(328)
2	(079)
3	(807)
4	(513)
5	(502)

↓ 51.7 mm
↔ 39.6 mm

No.29 **4 min**



1	(328)
2	(079)
3	(807)
4	(513)
5	(502)

↓ 52.2 mm
↔ 41.1 mm

No.30 **4 min**



1	(328)
2	(079)
3	(807)
4	(513)
5	(502)

↓ 51.9 mm
↔ 39.3 mm

No.31 **4 min**



1	(328)
2	(079)
3	(807)
4	(513)
5	(502)

↓ 53.1 mm
↔ 37.3 mm

No.32 **4 min**



1	(328)
2	(079)
3	(807)
4	(513)
5	(502)

↓ 52.1 mm
↔ 36.6 mm

No.33 4 min



1	(328)
2	(079)
3	(807)
4	(513)
5	(502)
↓	51.9 mm
↔	42.7 mm

No.37 5 min



1	(328)
2	(079)
3	(807)
4	(513)
5	(502)
↓	52.4 mm
↔	43.4 mm

No.41 4 min



1	(328)
2	(079)
3	(807)
4	(513)
5	(502)
↓	52.8 mm
↔	42.6 mm

No.45 4 min



1	(328)
2	(079)
3	(807)
4	(513)
5	(502)
↓	52.6 mm
↔	35.0 mm

No.49 5 min



1	(328)
2	(079)
3	(807)
4	(513)
5	(502)
↓	53.3 mm
↔	46.5 mm

No.34 5 min



1	(328)
2	(079)
3	(807)
4	(513)
5	(502)
↓	52.2 mm
↔	44.3 mm

No.38 3 min



1	(328)
2	(079)
3	(807)
4	(513)
5	(502)
↓	52.5 mm
↔	38.9 mm

No.42 4 min



1	(328)
2	(079)
3	(807)
4	(513)
5	(502)
↓	52.1 mm
↔	36.9 mm

No.46 4 min



1	(328)
2	(079)
3	(807)
4	(513)
5	(502)
↓	53.0 mm
↔	42.0 mm

No.50 4 min



1	(328)
2	(079)
3	(807)
4	(513)
5	(502)
↓	51.7 mm
↔	42.0 mm

No.35 4 min



1	(328)
2	(079)
3	(807)
4	(513)
5	(502)
↓	53.9 mm
↔	23.8 mm

No.39 6 min



1	(328)
2	(079)
3	(807)
4	(513)
5	(502)
↓	53.3 mm
↔	46.4 mm

No.43 4 min



1	(328)
2	(079)
3	(807)
4	(513)
5	(502)
↓	52.6 mm
↔	43.3 mm

No.47 4 min



1	(328)
2	(079)
3	(807)
4	(513)
5	(502)
↓	52.5 mm
↔	42.8 mm

No.51 4 min



1	(328)
2	(079)
3	(807)
4	(513)
5	(502)
↓	53.8 mm
↔	42.2 mm

No.36 3 min



1	(328)
2	(079)
3	(807)
4	(513)
5	(502)
↓	52.6 mm
↔	30.1 mm

No.40 5 min



1	(328)
2	(079)
3	(807)
4	(513)
5	(502)
↓	52.9 mm
↔	43.1 mm

No.44 4 min



1	(328)
2	(079)
3	(807)
4	(513)
5	(502)
↓	52.3 mm
↔	40.7 mm

No.48 4 min



1	(328)
2	(079)
3	(807)
4	(513)
5	(502)
↓	52.8 mm
↔	43.9 mm

No.52 4 min



1	(328)
2	(079)
3	(807)
4	(513)
5	(502)
↓	52.4 mm
↔	33.4 mm

No.53 2 min



1	(804)
2	(612)
3	(079)
4	(807)
5	(513)
6	(502)
↓	34.4 mm
↔	22.7 mm

No.55 4 min



1	(804)	3	(079)	5	(513)
2	(612)	4	(807)	6	(502)
↓ 39.3 mm ↔ 75.4 mm					

No.57 7 min

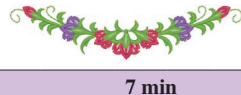

1	(804)	7	(804)	13	(079)
2	(612)	8	(612)	14	(807)
3	(079)	9	(079)	15	(513)
4	(807)	10	(807)	16	(502)
5	(513)	11	(513)		
6	(502)	12	(502)		
↓ 27.9 mm ↔ 121.9 mm					

No.54 2 min



1	(079)
2	(807)
3	(513)
4	(502)
↓	39.8 mm
↔	25.6 mm

No.56 7 min



1	(804)	5	(513)	9	(079)
2	(612)	6	(502)	10	(807)
3	(079)	7	(804)	11	(513)
4	(807)	8	(612)	12	(502)
↓ 23.4 mm ↔ 123.7 mm					

Embroidery Pattern Color Change Table
Stickmuster-Farbtabelle
Tableau de changement de couleur des motifs de broderie
Kleurwijzigingstabel voor de borduurpatronen
Tabella di cambiamento colori degli schemi di ricamo
Tabla de cambio de color para patrones de bordado
Fargeoppsett broderimønstre
Таблицы цветов нитей для вышивок



No. 58

13 min		
1 (079)	7 (513)	13 (079)
2 (807)	8 (502)	14 (807)
3 (513)	9 (079)	15 (513)
4 (502)	10 (807)	16 (502)
5 (079)	11 (513)	
6 (807)	12 (502)	
↕ 103.6 mm ↔ 94.9 mm		



No.60

5 min	
1 (513)	
2 (807)	
3 (513)	
4 (807)	
↕ 106.7 mm	
↔ 93.4 mm	



No.63

1 min	
1 (513)	
↕ 147.2 mm	
↔ 61.8 mm	



No.59

28 min		
1 (079)	17 (513)	33 (804)
2 (807)	18 (502)	34 (612)
3 (804)	19 (079)	35 (513)
4 (612)	20 (807)	36 (502)
5 (513)	21 (804)	37 (079)
6 (502)	22 (612)	38 (807)
7 (079)	23 (513)	39 (804)
8 (807)	24 (502)	40 (612)
9 (804)	25 (079)	41 (513)
10 (612)	26 (807)	42 (502)
11 (513)	27 (804)	43 (079)
12 (502)	28 (612)	44 (807)
13 (079)	29 (513)	45 (804)
14 (807)	30 (502)	46 (612)
15 (804)	31 (079)	47 (513)
16 (612)	32 (807)	48 (502)
↕ 218.4 mm ↔ 175.7 mm		



No.61

4 min	
1 (513)	
2 (807)	
3 (513)	
4 (807)	
↕ 42.6 mm	
↔ 142.0 mm	



No.64

8 min		
1 (804)	9 (079)	17 (513)
2 (612)	10 (807)	18 (502)
3 (079)	11 (513)	19 (804)
4 (807)	12 (502)	20 (612)
5 (513)	13 (804)	21 (079)
6 (502)	14 (612)	22 (807)
7 (804)	15 (079)	23 (513)
8 (612)	16 (807)	24 (502)
↕ 73.3 mm ↔ 72.8 mm		



No.62

15 min		
1 (513)	4 (807)	7 (513)
2 (807)	5 (513)	8 (807)
3 (513)	6 (807)	
↕ 216.6 mm ↔ 175.7 mm		

◆ Patterns for bobbin work

Bobbin work can only be performed in the "Embroidery Mode".

◆ Motifs pour le travail à la canette

Le travail à la canette ne peut être effectué qu'en « mode broderie ».

◆ Disegni per ricamo con spolina

Bobbin work può essere eseguito solo in "Modalità ricamo".

◆ Mønstre for spolearbeid

Spolearbeid kan bare utføres i "Broderimodus".

◆ Stickmuster für Bobbin Work

Bobbin Work kann nur im „Stickmodus“ ausgeführt werden.

◆ Patronen voor werken met de spoel

U kunt alleen in de borduurstand werken met de spoel.

◆ Patrones para efectos decorativos con bobinas

Los efectos decorativos con bobinas solo pueden realizarse en el "Modo de bordado".

◆ Рисунок для объемного вышивания с помощью устройства для объемного вышивания

Объемную вышивку можно выполнять только в режиме вышивания.

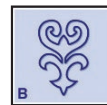

Note : Embroidery patterns for bobbin work are reversed when they have been sewn.

Hinweis : Stickmuster für Bobbin Work werden nach dem Nähen umgedreht.

Remarque : Les motifs de broderie pour le travail à la canette sont inversés lorsqu'ils sont cousus.

Opmerking : Borduurpatronen voor het werken met de spoel worden omgekeerd nadat deze zijn gemaakt.

Nota : I motivi per il ricamo con spolina vengono capovolti durante la cucitura.

Nota : Los patrones de bordado para efectos decorativos con bobinas se invierten una vez cosidos.

Bemerk : Broderimønstre for spolearbeid er omvendte når de har blitt sydd.

Примечание : Рисунки для объемного вышивания ложатся на нижнюю поверхность изделия.

All of the designs shown in the Bobbin work area are pictured in the machine mirrored or flipped.

Alle Designs, die im Bereich für Bobbin Work angezeigt sind, werden in der Maschine gespiegelt oder umgedreht.

Tous les motifs présentés dans l'aide du travail à la canette sont illustrés dans la machine à l'envers ou retournés.

Alle ontwerpen die in het werkgebied voor de spoel worden weergegeven, worden op de machine gespiegeld of omgeklapt afgebeeld.

Tutti i disegni illustrati nell'area Bobbin work sono raffigurati nella macchina speculari o capovolti.

Todos los diseños mostrados en el área de trabajo de la bobina se muestran en la máquina girados o invertidos.

Alle designene som vises under spolearbeid, er avbildet speilvendt eller vendt i maskinen.

Все дизайны в разделе объемной вышивки, отображаются в зеркальном или перевернутом виде.



No.1

3 min	
1	(030)
↓	175.1 mm
↔	97.0 mm
1.5 m (1.7 yd) (0.9 m + 0.6 m)	



Time is based on the recommended 100spm.

Die Zeit basiert auf den empfohlenen 100 spm.

La durée se base sur la vitesse recommandée de 100 points par minute.

Tijd is gebaseerd op de aanbevolen 100 spm.

Il tempo si basa sulla velocità consigliata di 100 punti/minuto.

El tiempo se basa en las 100 spm recomendadas.

Tid er basert på anbefalt 100 spm.

Время рассчитано на основе рекомендованной скорости 100 стежков в минуту.

Total length of thread needed to sew the pattern (to sew the pattern + to tie ends)
Erforderliche Gesamtfadenlänge zum Nähen des Musters (Muster nähen + Enden verknoten)

Longueur totale de fil nécessaire pour coudre le motif (coudre le motif + nouer les extrémités)

Totale lengte van de draad die nodig is om het patroon te maken (patroon naaien + uiteinden vastknopen)

Lunghezza totale del filo necessaria per la cucitura del motivo (cucire il motivo + annodare le estremità)

Longitud total de hilo necesario para coser el patrón (coser el patrón + atar los extremos)

Total trådlengde som trengs for å sy mønsteret (for å sy mønsteret + for å knytte endene)

Общая длина нити, необходимая для вышивания рисунка (вышивание рисунка + связывание концов)



No.2



4 min	
1	(509)
↓	123.6 mm
↔	127.0 mm
1.6 m (1.8 yd) (1.0 m + 0.6 m)	

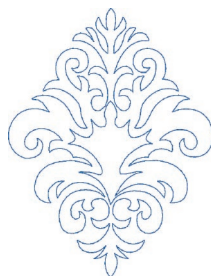

No.3



10 min	
1	(405)
↓	164.9 mm
↔	125.0 mm
2.8 m (3.1 yd) (2.2 m + 0.6 m)	



No.4



6 min	
1	(030)
↓	196.0 mm
↔	98.4 mm
2.3 m (2.6 yd) (1.7 m + 0.6 m)	

Refer to the operation manual for the sewing machine for details on how to embroider bobbin work patterns.

Weitere Hinweise zum Stickten von Bobbin Work finden Sie in der Bedienungsanleitung der Nähmaschine.

Reportez-vous au Manuel d'instructions de la machine à coudre pour plus de détails sur la broderie des motifs pour le travail à la canette.

Zie de bedieningshandleiding bij de naaimachine voor bijzonderheden over het borduren met de spoel.

Fare riferimento al manuale d'istruzione della macchina da cucire per i dettagli su come ricamare i disegni per il ricamo con spolina.

Para obtener más información sobre cómo bordar patrones para efectos decorativos con bobinas, consulte el manual de instrucciones de la máquina de coser.

Se i bruksanvisningen for symaskinen for informasjon om hvordan du broderer spolearbeidsmønstre.

Подробную информацию о вышивании объемных рисунков с помощью устройства для объемного вышивания см. в руководстве пользователя швейной машины.

Embroidery Pattern Color Change Table
Stickmuster-Farbtabelle
Tableau de changement de couleur des motifs de broderie
Kleurwijzigingstabel voor de borduurpatronen
Tabella di cambiamento colori degli schemi di ricamo
Tabla de cambio de color para patrones de bordado
Fargeoppsett broderimønstre
Таблицы цветов нитей для вышивок

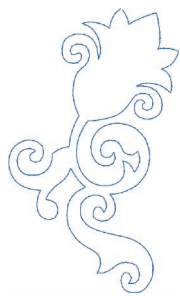

No.5	
5 min	
1	(405)
↕	174.8 mm
↔	104.4 mm
1.8 m (2.0 yd) (1.2 m + 0.6 m)	

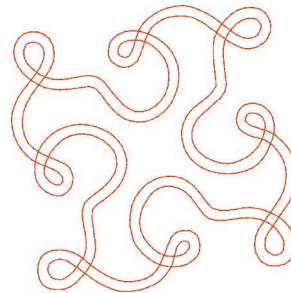

No.10	
7 min	
1	(030)
↕	126.2 mm
↔	125.9 mm
2.4 m (2.7 yd) (1.8 m + 0.6 m)	

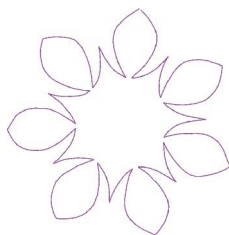

No.6	
4 min	
1	(620)
↕	135.5 mm
↔	133.3 mm
1.6 m (1.8 yd) (1.0 m + 0.6 m)	

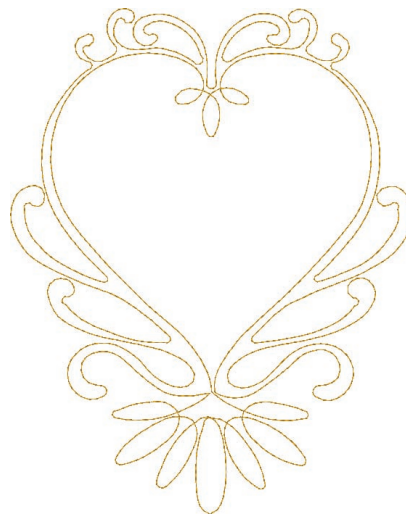

No.11	
10 min	
1	(328)
↕	223.5 mm
↔	177.3 mm
3.5 m (3.9 yd) (2.9 m + 0.6 m)	

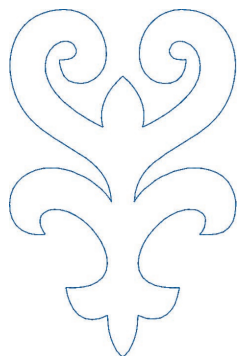

No.7	
3 min	
1	(405)
↕	153.9 mm
↔	100.0 mm
1.6 m (1.8 yd) (1.0 m + 0.6 m)	



No.8	
2 min	
1	(509)
↕	63.3 mm
↔	75.1 mm
1.1 m (1.2 yd) (0.5 m + 0.6 m)	



No.12	
8 min	
1	(542)
↕	123.5 mm
↔	135.5 mm
2.7 m (3.0 yd) (2.1 m + 0.6 m)	



No.9	
2 min	
1	(405)
↕	75.0 mm
↔	67.7 mm
1.0 m (1.1 yd) (0.4 m + 0.6 m)	



No.13	
6 min	
1	(209)
↕	81.5 mm
↔	118.3 mm
2.2 m (2.4 yd) (1.6 m + 0.6 m)	

Examples of Combinations
Exemples de combinaisons
Esempi di combinazioni
Eksempler på kombinasjoner

Kombinationsbeispiele
Voorbeelden van combinaties
Ejemplos de combinaciones
Примеры комбинирования

Combine various embroidery patterns, as shown below, to enhance your embroidering enjoyment.
 Wenn Sie verschiedene Stickmuster wie unten dargestellt miteinander kombinieren, macht das Stickten noch mehr Spaß.
 Combinez plusieurs motifs de broderie comme indiqué ci-dessous, pour un plaisir de broderie garanti.
 Zoals hieronder aangegeven kunt u diverse borduurpatronen combineren. Zo borduurt u met nog meer plezier.
 Combinare vari disegni da ricamo, come indicato di seguito, per rendere il ricamo ancora più divertente.
 Combine distintos patrones de bordado, como se muestra a continuación, para un mayor deleite al bordar.
 Kombiner ulike broderimønster, som vist nedenfor, for å få enda mer glede av broderingen.
 Чтобы получить красивые и оригинальные композиции, можно комбинировать различные рисунки, как это показано ниже.

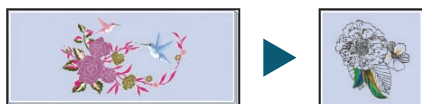

No.3 x 4



No.9 x 2



No.1 + No.2



No.4 x 2



No.3 + No.4



No.8 x 2

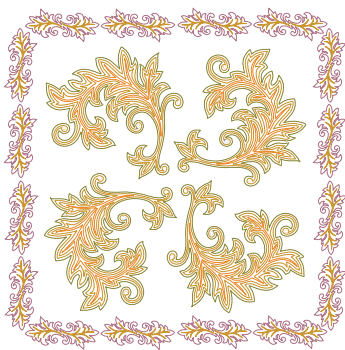
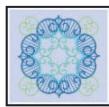

No.1 x 4 + No.2 x 16

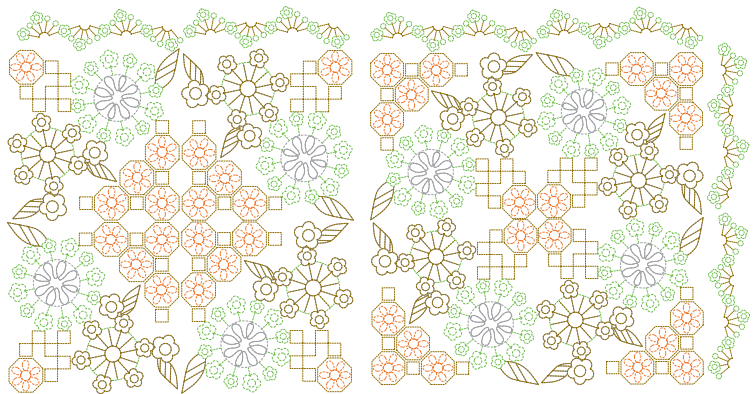

No.4 x 8 + No.5 x 6

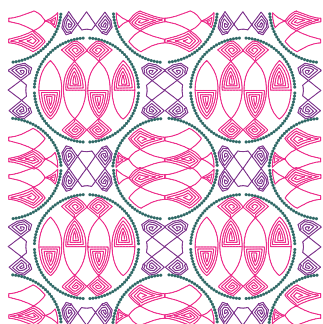

No.10 x 4



◆ 3D combination motifs

◆ Motifs de combinaison 3D

◆ Motivi tridimensionali combinati

◆ Kombinasjonsmotiv i 3D

◆ 3D-Kombinationsmotive

◆ 3D-combinatiemotieven

◆ Motivos de combinación 3D

◆ Комбинированные 3D вышивки

How to make 3D combination motifs

1. Use the same color of thread in the bobbin and on top for the designs.
2. Embroider individual shapes. When sections are completed they are joined to make dimensional shapes. Use a thread or narrow ribbon of a complimentary color to join them.

When embroidering on organza, tulle or similar fabrics, hoop together a single layer of water-soluble stabilizer with the fabric to be embroidered. When the embroidery process is complete, remove from the hoop and thoroughly rinse embroidered piece in warm water. Dry until the piece is slightly damp, shape by hand or with cool iron. When dry, trim edges.

The following are things you should be aware of when using water-soluble sheets without any fabric. When embroidering these designs, please use three layers of water-soluble sheets. Remember to check that you have enough upper thread and lower thread for the design. If the thread breaks during embroidery, back up at least 10 stitches before starting again. If your embroidery machine has a speed reduction feature, select the lowest speed. When dissolving the water-soluble sheet, cut off the unnecessary portions and wash the embroidered piece in warm water until it no longer feels slippery. After the final rinse, dry the embroidery motif until slightly damp, shape by hand or with a cool iron, allow to dry completely.

Comment réaliser des combinaisons de motifs 3D

1. Utilisez la même couleur de fil dans la bobine et sur le dessus pour les motifs.
2. Brodez les formes séparément. Lorsque les différentes parties sont complétées, elles sont jointes pour créer des formes en volume. Utilisez un fil ou un ruban étroit d'une couleur complémentaire pour les joindre.

Lorsqu'il s'agit d'une broderie sur de l'organza, du tulle ou des tissus similaires, cercelez ensemble une seule couche de stabilisateur hydrosoluble et le tissu à broder. Lorsque l'étape de broderie est terminée, décernez et rincez soigneusement la pièce brodée à l'eau tiède. Faites sécher jusqu'à ce que la pièce soit légèrement humide avant de lui donner sa forme à la main ou avec un fer à repasser froid. Une fois qu'elle est complètement sèche, coupez les bords.

Voici ci-dessous les points que vous devez considérer lorsque vous utilisez uniquement des feuilles solubles dans l'eau pour la broderie sans aucun tissu. Lorsque vous brodez ces motifs, veuillez utiliser trois couches de feuilles hydrosolubles. Assurez-vous de bien vérifier que vous avez assez de fil supérieur et de fil inférieur pour le motif. Si le fil casse au cours de la broderie, consolidez au moins 10 points avant de recommencer. Si votre machine à broder est équipée d'une fonction de réduction de la vitesse, veuillez choisir la vitesse la plus lente. Lors de la dissolution de la feuille hydrosoluble, coupez les parties inutiles et lavez la pièce brodée à l'eau tiède jusqu'à ce qu'elle ne soit plus glissante. Après le rinçage final, séchez le motif de broderie jusqu'à ce qu'il ne soit plus que légèrement humide, donnez-lui sa forme à la main ou avec un fer à repasser froid avant de le laisser sécher complètement.

Come creare motivi tridimensionali combinati

1. Per la parte superiore nei disegni usare lo stesso colore di quello del rocchetto.
2. Ricamare le forme individualmente. Una volta completate le sezioni le si può unire per creare forme dimensionali. Per l'unione si suggerisce di usare un filo o un nastro stretto del colore desiderato.

Durante il ricamo su organza, tulle o tessuti simili è opportuno cerchiare con il tessuto da ricamare un singolo strato di stabilizzante solubile in acqua. Al termine del ricamo si dovrà quindi rimuovere il cerchio e risciacquare bene il pezzo ricamato in acqua calda. Lasciare asciugare sino a quando rimane solo lievemente umido e dare quindi la forma desiderata a mano o con un ferro da stiro freddo. Una volta asciutto tagliare i bordi.

In caso d'uso di pellicole solubili in acqua per ricamo senza tessuto occorre essere consapevoli dei seguenti aspetti: Per ricamare quei disegni si suggerisce di usare tre strati di pellicola solubile in acqua. Ricordarsi di accertarsi di disporre di filo superiore e inferiore a sufficienza per il disegno. Se durante il ricamo il filo si spezza, prima di riprendere a ricamare tornare indietro almeno dieci punti. Se la propria macchina da cucire dispone della funzione di regolazione della velocità occorre selezionare la più bassa. Durante lo scioglimento della pellicola solubile in acqua occorre rimuovere le parti non necessarie e risciacquare il ricamo in acqua calda sino a quando cessa di essere viscido. Dopo il risciacquo finale il motivo ricamato andrà lasciato asciugare sino a quando rimarrà lievemente umido, quindi gli si darà la forma desiderata a mano o con un ferro da stiro freddo lasciandolo poi asciugare completamente.

Anfertigen von 3D-Kombinationsmotiven

1. Verwenden Sie für die Muster Faden derselben Farbe in der Spule und oben.
2. Sticken Sie die einzelnen Formen. Die fertigen Abschnitte werden zusammengefügt, um plastische Formen zu schaffen. Verwenden Sie zum Zusammenfügen ein Garn oder schmales Band in einer passenden Farbe.

Beim Sticken auf Organza, Tüll oder ähnlichen Stoffen spannen Sie eine einzelne Lage wasserlösliche Folie mit dem zu bestickenden Stoff in den Rahmen. Nach dem Sticken nehmen Sie die Stickarbeit aus dem Rahmen und spülen sie gründlich mit warmem Wasser. Lassen Sie die Arbeit trocknen, bis sie nur leicht feucht ist, und formen Sie sie von Hand oder mit einem kalten Bügeleisen aus. Sobald sie trocken ist, schneiden Sie die Kanten gerade.

Die folgenden Punkte sind zu beachten, wenn für eine Stickarbeit nur wasserlösliche Folie ohne Stoff verwendet wird. Verwenden Sie beim Sticken solcher Muster bitte drei Lagen wasserlösliche Folie. Achten Sie darauf, dass ausreichend Ober- und Unterfaden für das Muster vorhanden ist. Sollte der Faden beim Sticken reißen oder ausgehen, gehen Sie zum Weitersticken mindestens 10 Stiche zurück. Falls Ihre Stickmaschine eine Geschwindigkeitsregelung hat, wählen Sie die langsamste Stufe. Zum Auflösen der wasserlöslichen Folie schneiden nicht benötigte Teile ab und waschen die Stickarbeit in warmem Wasser aus, bis sie sich nicht mehr schlüpfrig anfühlt. Nach dem letzten Spülvorgang lassen Sie das Stickmotiv trocknen, bis es leicht feucht ist, formen es von Hand oder mit einem kalten Bügeleisen aus, und lassen es dann vollständig trocknen.

Hoe maak ik 3D Combinatiemotiefjes

1. Gebruik dezelfde kleur draad in de spoel en aan de bovenkant voor elk ontwerp.
2. Borduur afzonderlijke vormen. Als alle onderdelen klaar zijn worden ze bij elkaar gevoegd om dimensionale vormen te maken. Gebruik draad of lint van een gepaste kleur om de onderdelen samen te voegen.

Wanneer U borduurt op organza, tule of soortgelijk textiel, verbind dan een enkele laag wateroplosbare stabilisator met het te borduren textielwerk. Wanneer het borduurproces compleet is, verwijder dan het borduurwerk van de stabilisator en was het grondig in warm water. Laat het drogen tot het nog licht vochtig is en geef het daarna vorm met de hand of met een koud strijkijzer. Wanneer het volledig droog is kunt U de randjes bijknippen.

Als U alleen wateroplosbaar papier gebruikt voor het borduren zonder textiel, dient U de volgende dingen in acht te houden. Indien U die onderwerpen borduurt, gebruik dan drie lagen van het wateroplosbare papier. Vergeet niet van tevoren vast te stellen dat U genoeg bovendraad en onderdraad voor het ontwerp heeft. Mocht de draad breken tijdens het borduren, ga dan minstens 10 steken terug voordat U weer opnieuw begint. Als uw borduurmachine een functie voor snelheidsreductie heeft, kies dan de laagst mogelijke snelheid. Wanneer U het wateroplosbare papier oplost, verwijder de onnodige delen en was het borduurwerk in warm water tot het niet meer glad aanvoelt. Laat na de laatste spoelbeurt het borduurmotief drogen tot het licht vochtig is, vorm het vervolgens met de hand of met een koud strijkijzer, en laat het volledig drogen.

Cómo realizar motivos de combinación 3D

1. Utilice el mismo color de hilo en la bobina y en la parte superior para los diseños.
2. Borde talles individuales. Cuando se finalizan las secciones, se juntan para componer talles dimensionales. Utilice un hilo o una cinta estrecha de color complementario para unirlos.

Cuando borde en organza, tul, o tejidos similares, ciña juntas una sola capa de estabilizador soluble en agua con la tela que vaya a bordar. Cuando finalice el proceso de bordado, elimine del tejido y enjuague completamente la pieza bordada en agua caliente. Seque la pieza hasta que esté ligeramente húmeda, y déle forma con la mano o con un plancha. Cuando esté seca, recorte los bordes.

A continuación se indica lo que usted deberá tener en cuenta cuando utilice solamente láminas solubles en agua para bordar sin ninguna tela. Cuando borde tales diseños, utilice tres capas de láminas solubles en agua. No se olvide de comprobar si tiene hilo superior e inferior para el diseño. Si el hilo se rompe durante el bordado, vuelva atrás 10 puntadas por lo menos antes de comenzar de nuevo. Si su máquina de bordar posee función de reducción de velocidad, seleccione la velocidad más baja. Cuando disuelva la lámina soluble en agua, corte las partes innecesarias, y lave la pieza bordada en agua caliente hasta que deje de notarse resbaladiza. Después del lavado final, seque el adorno bordado hasta que esté ligeramente húmedo, déle forma con la mano o con un plancha fría, y deje que se seque completamente.

Slik lager du kombinasjonsmotiv i 3D

1. Bruk samme trådfarge i spolen og på toppen for designene.
2. Broder individuelle former. Når områder fullføres, føyes de sammen for å skape dimensionale former. Bruk en tråd eller en smalt bånd i en komplementærfarge til å sammenføye dem.

☞ Ved brodering på organza, tyll eller lignende stoffer fester du et enkelt ark med vannløselig stabilisator til stoffet som det skal broderes på. Når broderingen er ferdig, fjerner du stoffet fra arket og skyller broderidelen grundig i varmt vann. Tørk broderidelen til den fremdeles er litt fuktig, og form for hånd eller med et kaldt strykejern. Klipp til kantene når delen er tørr.

☞ Følgende er ting du må være obs på når du bruker vannløselige ark uten stoff. Når disse designene broderes, bruk tre lag med vannløselige ark. Husk å sjekke at du har nok overtråd og undertråd for designen. Hvis tråden ryker under brodering, gå minst ti maskertilbake før du starter på nytt. Hvis broderimaskinen har en hastighetsredueringsfunksjon, velg laveste hastighet. Når du løser opp vannløselige ark, kutt av unødvendige deler og vask broderidelen i varmt vann helt til det ikke lenger føles glatt. Etter siste skylling, tørk broderimotivet til det er litt fuktig, form for hånd eller med et kaldt strykejern, og la motivet tørke helt.

No.6 x 6

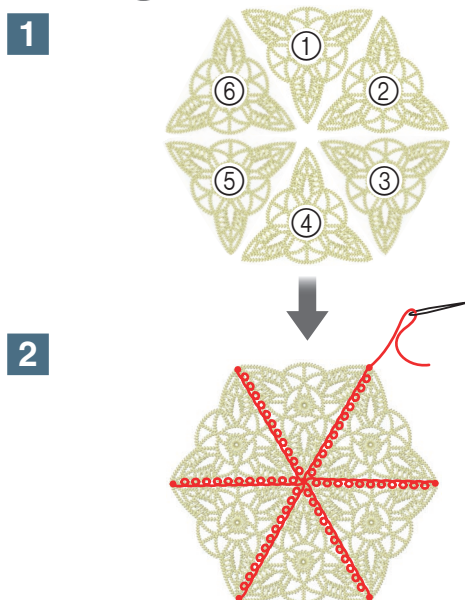

No.12

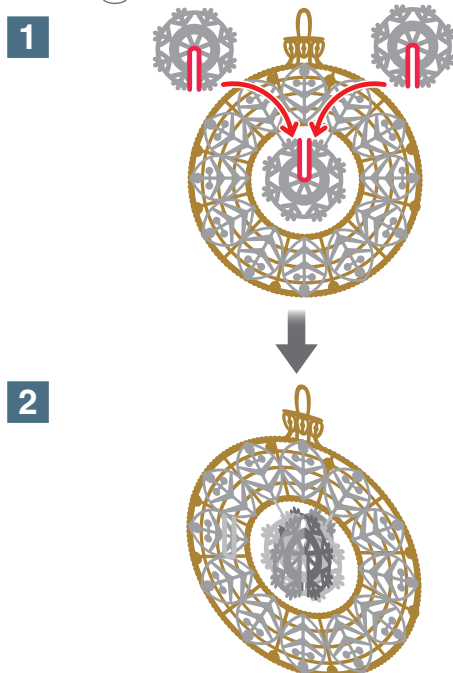

Создание комбинированной 3D вышивки

1. Используйте нити одного цвета в шпульке и на лицевой стороне рисунка.
2. Вышейте отдельные фигуры. После завершения вышивания отдельных частей получатся объемные фигуры. Для их соединения используйте нить или узкую ленту подходящего цвета.

☞ Когда вышивка осуществляется на органзе, тюле или похожих материалах, запыляйте вместе одинарный слой водорастворимого стабилизатора и сам материал, на котором необходимо сделать вышивку. Когда вышивка закончена, снимите пяльцы и тщательно промойте изделие в теплой воде. Высушите изделие до слегка влажного состояния, затем расправьте руками или негорячим утюгом. Когда изделие окончательно высохнет, обрежьте края.

☞ При использовании водорастворимых листов без материала необходимо учитывать следующее. При вышивании таких дизайнов используйте водорастворимые листы в три слоя. Не забудьте проверить, что для вышивания имеется достаточно верхней и нижней нити. Если нить порвется во время вышивания, перед продолжением вышивания вернитесь как минимум на 10 стежков назад. Если на вышивальной машине имеется функция снижения скорости, выберите самую низкую скорость. При растворении водорастворимого листа обрежьте ненужные части листа и промойте вышивку теплой водой до тех пор, пока она не перестанет быть скользкой на ощупь. Затем окончательно промойте вышитое изделие, высушите его так, чтобы оно было немного влажным, придайте ему форму рукой или негорячим утюгом и дайте окончательно высохнуть.

No.13 x 3

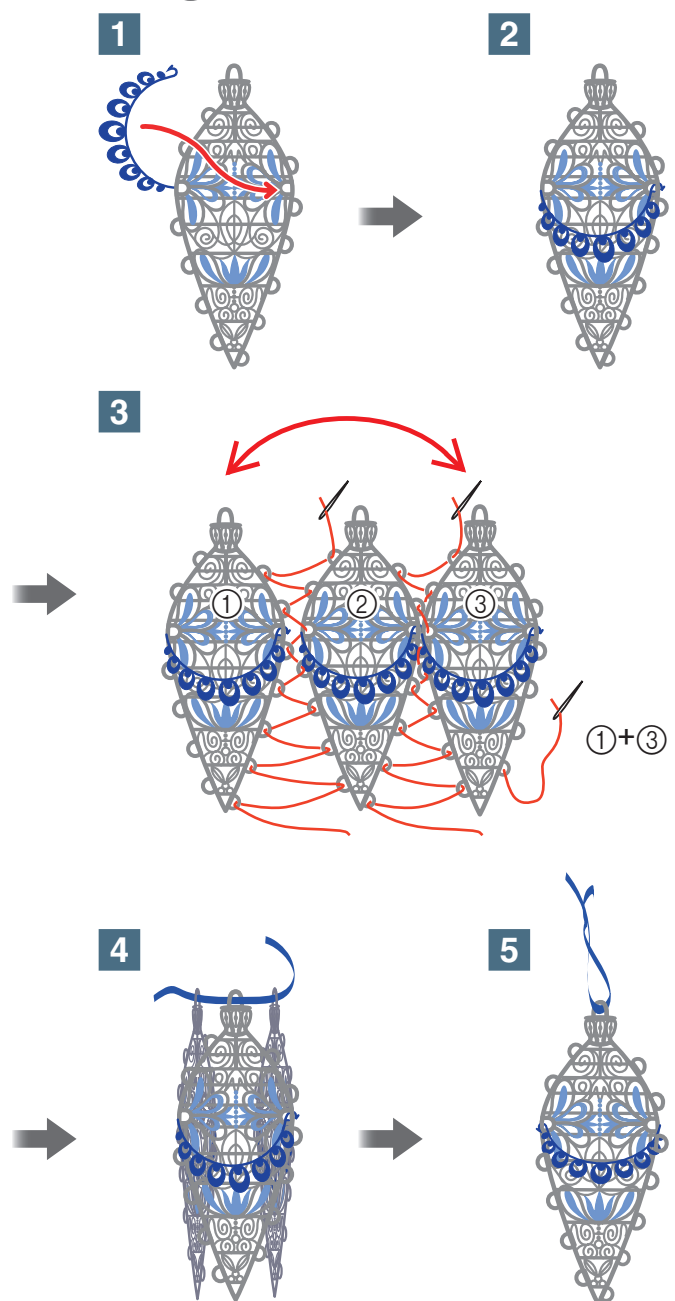

No.14 

A



No.14 x 9 

B

1

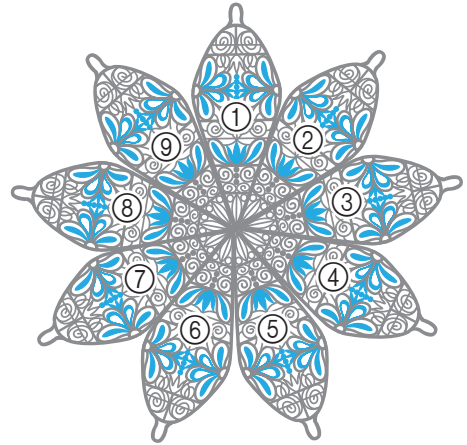

2

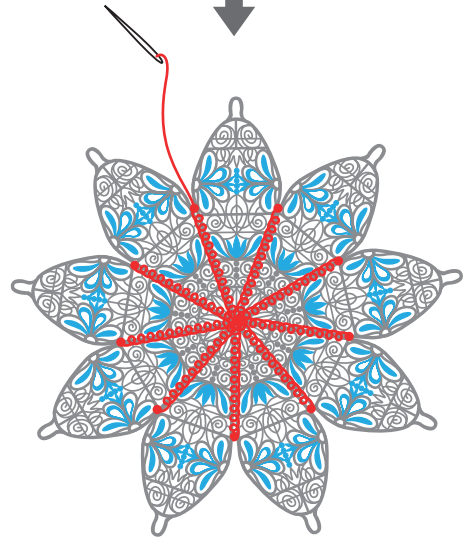

No.15 

1

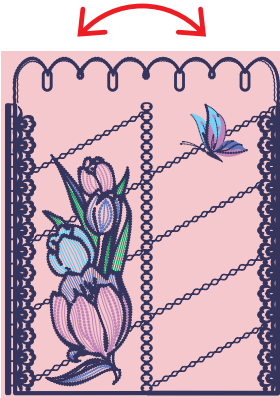

2

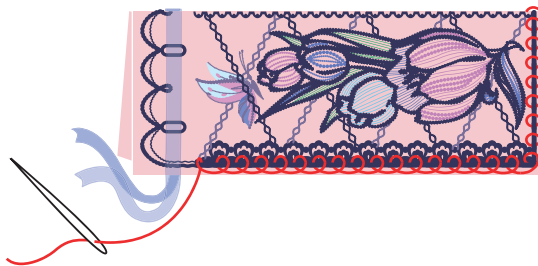

3

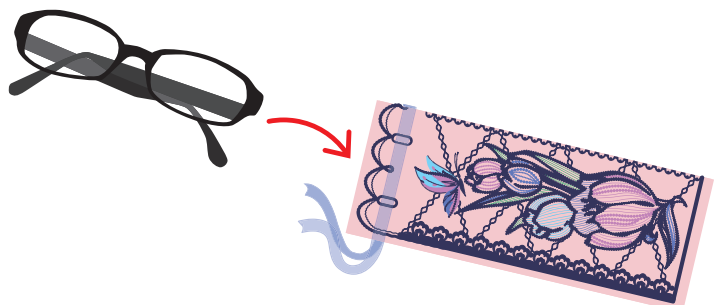

Color Thread Conversion Chart

Tableau de conversion des fils de couleur

Tabella di conversione dei fili colorati



Fargekart, konvertert til andre leverandører sine fargenummer













































Stickgarn-Farbtabelle

Omzettingstabel voor kleurgaren

Tabla de conversión de hilos de color

Таблица преобразования цветов нитей

	Color Name / Name der Farbe / Nom de la couleur / Kleur naam / Nome del colore / Nombre de color / Fargenavn / Наименование цвета	Embroidery	Country	Madeira Polyneon	Madeira Rayon	Sulky	R.A. Polyester
1	Black / Schwarz / Noir / Zwart / Nero / Negro / Sort / Черный	 900	 100	1800	1000	1005	5596
2	White / Weiss / Blanc / Wit / Bianco / Blanco / Hvit / Белый	 001	 000	1801	1002	1001	5597
3	Red / Rot / Rouge / Rood / Rosso / Rojo / Rød / Красный	 800	 149	1637	1037	1037	5678
4	Pink / Rosa / Rose / Rose / Rosa / Rosado / Lyserød / Розовый	 085	 155	1921	1108	1224	5523
5	Deep Rose / Tiefrot / Rose foncé / Roserood / Rosa Intenso / Rosa Intenso / Dyprosa / Темно-розовый	 086	 024	1721	1117	1154	9168
6	Flesh Pink / Fleischfarben / Rose chair / Lichtrose / Rosa Carne / Rosa Claro / Hudfarge / Свежий розовый	 124	 152	1915	1015	1064	5677
7	Dark Fuchsia / Dunkelviolett / Fuchsia foncé / Donker Fuchsia Paars / Fuchsia Scuro / Fuchsia Oscuro / Mørk Fuchsia / Цвет темной фуксии	 107	 126	1984	1383	1533	5804
8	Vermillion / Zinnoberrrot / Vermillon / Vermil Joen / Rosso Vermiglio / Bermellon / Sinober Rød / Багряный	 030	 148	1779	1179	1184	9023
9	Carmine / Karminrot / Carmin / Karmijn / Rosso Carminio / Carmin / Karmin / Карминный	 807	 158	1986	1081	1511	5561
10	Royal Purple / Königsapur / Pourpre royal / Dieppaars / Rosso-Violaceo / Violeta Real / Konge Purpur / Яркий пурпурный	 869	 636	1788	1188	1192	5681
11	Magenta / Magenta / Magenta / Magenta / Magenta / Magenta / Фуксин	 620	 625	1710	1319	1191	5592
12	Salmon Pink / Lachsrosa / Rose saumon / Zalmrose / Rosa Salmone / Rosa Salmon / Lakse Farget / Оранжево-розовый	 079	 122	1816	1317	1225	5773
13	Amber Red / Bernsteinrot / Rouge ambre / Amber Rood / Rosso Ambra / Rojo Ambar / Ravrød / Янтарнокрасный	 333	 212	1942	1341	1119	5591
14	Lemon Yellow / Zitronengelb / Jaune citron / Citro Engeel / Giallo Limone / Amarillo Limon / Sitrongul / Лимоножелтый	 202	 342	1623	1023	1067	5625
15	Yellow / Gelb / Jaune / Geel / Giallo / Amarillo / Gul / Желтый	 205	 043	1980	1068	1187	5860
16	Harvest Gold / Erntegold / Or blé / Oogst Kleurig Goud / Giallo Grano / Amarillo Trigo / Høstgull / Желтозолотистый	 206	 334	1971	1024	1124	5770
17	Orange / Orange / Orange / Oranje / Arancio / Naranja / Orange / Оранжевый	 208	 335	1951	1137	1024	5694
18	Pumpkin / Kürbisgelb / Citrouille / Pompoen / Giallo Zucca / Calabaza / Gresskar / Тыквенный	 126	 322	1952	1155	1065	5630
19	Tangerine / Mandarinenorange / Tangerine / Felorange / Mandarino / Tangerina / Tangerin / Мандаринный цвет	 209	 336	1965	1078	1078	5518
20	Cream Brown / Braun Weiss / Brun crème / Creme Bruin / Nocciola / Marron Crema / Krembrun / Кремовый	 010	 331	1866	1022	1061	5761
21	Cream Yellow / Gelblich Weiss / Jaune crème / Cremegeel / Giallo Crema / Amarillo Crema / Kremgul / Кремвожелтый	 812	 370	1861	1349	1135	5564
22	Khaki / Khakibraun / Kaki / Khaki / Kaki / Saqui / Khaki / Цвет хаки	 348	 242	1939	1255	1055	5636
23	Deep Gold / Tiefgold / Or foncé / Diepgoud / Oro Scuro / Amarillo Oro / Mørk Gull / Глубокий золотой	 214	 354	1772	1172	1025	5770
24	Brass / Messingfarben / Cuivre / Koper / Ottone / Bronze / Messing / Цвет латуни	 328	 404	1791	1192	1159	9109
25	Linen / Leinen Farbig / Drap / Linnen / Lino / Lino / Lin / Льяной	 307	 025	1682	1149	1082	5635
26	Dark Brown / Dunkelbraun / Brun sombre / Donker Bruin / Marrone Scuro / Marron Oscuro / Mørk Brun / Темно-коричневый	 058	 717	1859	1130	1129	5637
27	Reddish Brown / Rotbraun / Brun rougeâtre / Rossing Bruin / Marrone Bruciato / Marron Rojizo / Rødbrun / Краснокоричневый	 337	 264	1753	1253	1021	5781
28	Clay Brown / Lehmbraun / Brun argile / Kleibruin / Marrone Argilla / Marron Tierra / Leirbrun / Коричневый	 339	 224	1621	1021	1158	5590
29	Beige / Beige / Beige / Beige / Beige / Beige / Beige / Бежевый	 843	 012	1738	1138	1127	5598
30	Warm Gray / Warmgrau / Gris vif / Warm Grijs / Grigio Caldo / Gris Caliente / Varmgrå / Теплый серый	 399	 706	1860	1085	1218	9126
31	Russet Brown / Rotbraun / Brun roussâtre / Roodbruin / Ruggine / Marron Bermejo / Rødbrun / Желтокоричневый	 330	 414	1726	1194	1126	5702
32	Light Brown / Hellbraun / Brun clair / Licht Bruin / Marrone Chiaro / Marron Claro / Lys Brun / Светло-коричневый	 323	 255	1729	1056	1128	5789
33	Seacrest / Blassgrün / Vert pale / Blauw Groen / Cresta Di Mare / Verde Celadon / Havblå / Сероголубой	 542	 505	1647	1219	1077	5578
34	Mint Green / Pfefferminzgrün / Vert menthe / Munt Groen / Verde Menta / Verde Menta / Mynte Grønn / Мятный зеленый	 502	 461	1702	1302	1047	5511
35	Leaf Green / Blattgrün / Vert feuille / Bladgroen / Verde Prato / Verde De Hoja / Blad Grønn / Цвет зеленой лиспы	 509	 463	1749	1050	1510	5514
36	Olive Green / Olivgrün / Vert olive / Oljif Groen / Verde Oliva / Verde Oliva / Oliven Grønn / Зеленый оливковый	 519	 476	1904	1396	1174	5502
37	Dark Olive / Dunkelolivgrün / Olive foncé / Donker Olijf / Oliva Scuro / Verde Oliva Oscuro / Mørk Oliven / Темно-оливковый	 517	 473	1769	1156	1156	9122
38	Teal Green / Blaugrün / Vert saccelle / Taling Groen / Verde Anatra / Verde Azulado / Teal Grønn / Зеленый чирка	 534	 483	1879	1298	1503	5751
39	Emerald Green / Emerald Grün / Vert émeraude / Smaragd Groen / Verde Smeraldo / Verde Esmeralda / Smaragd Grønn / Изумрудный	 507	 485	1750	1250	1079	5508

	Color Name / Name der Farbe / Nom de la couleur / Kleur naam / Nome del colore / Nombre de color / Fargenavn / Наименование цвета	Embroidery	Country	Madeira Polyneon	Madeira Rayon	Sulky	R.A. Polyester
40	Deep Green / Dunkelgrün / Vert foncé / Diepgroen / Verde Intenso / Verde Intenso / Dyp Grønn / Темно-зеленый	 808	 467	1703	1370	1208	5615
41	Fresh Green / Frischgrün / Vert frais / Licht Groen / Verde Mela / Verde Fresco / Frisk Grønn / Цвет свежей зелени	 027	 442	1706	1102	1209	9153
42	Lime Green / Limonengrün / Vert tilleul / Limoen Groen / Verde Tiglio / Verde Lima/ Lindegrønn / Лаймовый зеленый	 513	 444	1848	1049	1177	5622
43	Moss Green / Moosgrün / Vert mousse / Mosgroen / Verde Muschio / Verde Musgo / Mosegrønn / Серозеленый	 515	 446	1770	1369	1176	9091
44	Blue / Blau / Bleu / Blauw / Azzurro / Azul / Blå / Синий	 405	 586	1829	1177	1076	5684
45	Ultra Marine / Ultra Marin / Outremer / Ultra Marijn / Blu Oltremare / Azul De Ultramar / Ultra Marin / Ультрамарин	 406	 575	1842	1076	1042	5736
46	Light Blue / Hellblau / Bleu clair / Licht Blauw / Celeste / Azul Claro / Lys Blå / Светло-голубой	 017	 150	1932	1132	1074	5683
47	Sky Blue / Himmelblau / Bleu ciel / Hemels Blauw / Azzurro Cielo / Celeste / Himmelblå / Лазурь	 019	 512	1828	1029	1196	5506
48	Electric Blue / Elektrischblau / Bleu électrique / Staal Blauw / Blu Elettrico / Azul Electrico / Elektro Blå / Электрик	 420	 564	1797	1297	1250	5829
49	Peacock Blue / Pfauenblau / Bleu paon / Pauwen Blauw / Blu Pavone / Azul Pavo Real / Påfuglblå / Переливчатый синий	 415	 057	1652	1252	1206	5810
50	Prussian Blue / Berliner Blau / Bleu de Prusse / Pruisisch Blauw / Blu De Prussia / Azul De Prusia / Berliner Blå / Берлинская лазурь	 007	 588	1767	1166	1535	5737
51	Cornflower Blue / Kornblumenblau / Bleu centauree / Koren Bloemen Blauw / Blu Fior-Daliso / Azul Centaura / Kornblå / Васильковый	 070	 015	1830	1335	1028	5601
52	Light Lilac / Helllila / Lilas clair / Licht Lila / Lilla Chiaro / Lila Suave / Lys Lilla / Светло-сиреневый	 810	 133	1911	1031	1121	9016
53	Lilac / Lila / Lilas / Lila / Lilla / Lila / Lilla / Сиреневый	 612	 623	1831	1080	1080	9009
54	Violet / Violett / Violet / Violet / Violetto / Violeta / Violett / Фиолетовый	 613	 624	1631	1033	1194	5588
55	Purple / Purpur / Pourpre / Paars / Viola / Purpura / Purpur / Пурпурный	 614	 635	1880	1122	1122	5554
56	Lavender / Lavendel / Lavande / Lavendel / Lavenda / Lavanda / Lavendel / Лавандовый	 804	 604	1630	1261	1193	5586
57	Wisteria Violet / Wistaria Violett / Violet glycine / Blauwe Regen Paars / Glicine / Violeta Vistaria / Wistaria Violett / Цвет глицинии	 607	 003	1943	1311	1032	5587
58	Pewter / Zinngrau / Étain / Tinkleurig / Peltro / Peltre / Tinnfarge / Цвет пьютера	 704	 745	1840	1041	1041	9114
59	Dark Gray / Dunkelgrau / Gris sombre / Donker Grijs / Grigio Scuro / Gris Oscuro / Mørk Grå / Темно-серый	 707	 747	1841	1241	1220	5565
60	Silver / Silber / Argent / Zilver / Argento / Plata / Sølv / Серебряный	 005	 020	1812	1087	1011	5640
61	Gray / Grau / Gris / Grijs / Grigio / Gris / Grå / Серый	 817	 734	1640	1118	1219	5782
62	----->						
63	-----						
64							
65	NOT DEFINED / NICHT DEFINIERT / NON DEFINI / NIET GEDEFINIEERD / NON DEFINITO / SIN DEFINIR / IKKE DEFINERTE / НЕ ОПРЕДЕЛЕНО						

Color Thread Conversion Chart
Stickgarn-Farbtabelle
Tableau de conversion des fils de couleur
Omzettingstabel voor kleurgaren
Tabella di conversione dei fili colorati
Tabla de conversión de hilos de color
Fargekart, konvertert til andre leverandører sine fargenummer
Таблица преобразования цветов нитей

- Note:** *The conversion chart is based on Embroidery thread. The color shades may vary with the different brands listed on the chart. If unsure of a particular color(s), please sew test. Robison Anton (R.A.), Madeira and Sulky are respectively registered trademarks. Actual colors may vary slightly from the chart.*
- Hinweis:** *Die Umrechnungstabelle basiert auf dem Stickgarn. Die Farbschattierungen können je nach unterschiedlichen, in der Tabelle aufgeführten Marken abweichen. Wenn Sie sich bei bestimmten Farben nicht sicher sind, nähen Sie bitte zur Probe. Robison Anton (R.A.), Madeira und Sulky sind eingetragene Warenzeichen. Die tatsächlichen Farben können leicht von der Tabelle abweichen.*
- Remarque:** *Le tableau de conversion est basé sur le fil de broderie. Les nuances de couleur peuvent varier en fonction des marques énumérées dans le tableau. En cas de doute sur un coloris, faites un essai de couture. « Robison Anton (R.A.) », « Madeira » et « Sulky » sont des marques déposées respectives. Les couleurs réelles risquent d'être légèrement différentes de celles du tableau.*
- Opmerking:** *Het omzettingsschema is gebaseerd op het gebruik van borduurzijde. De kleurtinten kunnen ietwat verschillen voor de diverse merken in het schema. Bent u niet zeker bent van de juiste kleur(en), borduur dan een stukje op proef. De namen Robison Anton (R.A.), Madeira en Sulky zijn allemaal gedeponeerde handelsmerken. De feitelijke kleurtinten kunnen iets afwijken van het getoonde schema.*
- Nota:** *La tabella di conversione è in funzione del filo da ricamo. Le tonalità cromatiche possono variare secondo le differenti marche elencate nella tabella. In caso di dubbio su un particolare colore o su più colori si raccomanda di eseguire una prova di cucito. Robison Anton (R.A.), Madeira e Sulky sono marchi di fabbrica registrati. I colori effettivi possono variare lievemente rispetto a quelli della tabella.*
- Nota:** *La tabla de conversión está basada en hilo de bordar. Los tonos de color podrán variar con las diferentes marcas enumeradas en la tabla. Si tiene dudas sobre un color o colores en particular, haga un cosido de prueba. Robison Anton (R.A.), Madeira y Sulky son marcas registradas respectivamente. Los colores verdaderos podrán variar ligeramente con respecto a los de la tabla.*
- Merk:** *Omregningstabellen er basert på broderitråd. Fargenyansene kan variere med de forskjellige merkene i tabellen. Hvis du er usikker på en bestemt farge, sy en prøvelapp. Robison Anton (R.A.), Madeira og Sulky er begge registrerte varemerker. Faktiske farger kan variere noe fra tabellen.*
- Примечание:** *Таблица преобразования составлена на базе вышивальных нитей. Оттенки цветов могут варьироваться в зависимости от производителей, указанных в таблице. Если вы не уверены в выборе какого-то конкретного цвета, произведите пробную вышивку. Robison Anton (R.A.), Madeira и Sulky являются зарегистрированными товарными знаками. Реальные цвета могут несколько отличаться от представленных в таблице.*

English
German
French
Dutch
Italian
Spanish
Norwegian
Russian

882-C50
Printed in Taiwan



XF6503-001