



Low Voltage Brushless DC Gearmotor

Instruction Manual

<Read this Manual before using the product.>

VG (Inline Shaft)



VH (Right Angle Shaft)



VF3 (Right Angle Hollow Bore)
(Right Angle Solid Shaft)





Brother International Corporation

Introduction



Thank you for purchasing the Brother Brushless DC series.









Safety precautions

- Be sure to carefully read the contents described in this Instruction Manual and to master how to use the product correctly before using it.
- Extents of hazard/damage expected to occur in the case of inept handling are basically classified and indicated into ranks of “Danger”, “Warning” and “Caution” in this Instruction Manual. The definitions and indications are as follows:















 Danger	Cases where it is expected that a degree of danger is extremely high such that inept handling possibly causes a dangerous situation to occur, which may lead to death or serious injury.
 Warning	Cases where inept handling possibly causes a dangerous situation to occur, which may lead to death or serious injury.
 Caution	Cases where inept handling possibly causes a dangerous situation to occur, from which it is expected a medium degree of injury or minor one may be incurred.

Even the items described in “Caution” may lead to a serious accident depending on situation. Be sure to observe every instruction which deals with important contents.



































	: The symbol \triangle indicates “what you should pay attention to.” (The example on the left shows “Electric Shock Hazard.”)
	: The symbol \circ indicates “what you must not do.” Specific “don’t” item is depicted in the circle. (The example on the left shows “Don’t Disassemble.”)
	: The symbol \bullet indicates “what you must do.” Specific “do” item is depicted in the circle. (The example on the left shows “Ground Connection.”)

 Danger	
 	If the product is used in a device such as a personnel transport device, make sure to install a protective device for safety purposes. Failure to implement safety measures may result in personal injury, death, and/or damage to the device.
 	If the product is used in an elevator, install a safety device on the device side to prevent it from falling. Failure to implement safety measures may result in personal injury, death, and/or damage to the device due to the falling of the elevator.
 	Do not use the product in an explosive environment. Failure to follow this precaution may result in explosions, ignition of fire, fire, electric shocks, injuries, and/or damage to the device.
 	Do not change the wiring while the product is energized. Failure to follow this precaution may result in fire, electric shock, and/or damage to the device.

⚠ Warning

		Never use the product in a location where the motor may be exposed to splashes of water, corrosive substances, flammable gas, and/or flammable objects. Failure to follow this precaution may result in fire or accidents.
		The operators in charge of transportation, installation, wiring, operation, handling, maintenance, and inspection should have enough knowledge and technical skill related to the product. Failure to follow this precaution may result in explosion, ignition of fire, fire, electric shock, injury, and/or damage to the device.
		When the operation has stopped due to the occurrence of error or activated safeguards, do not re-start the operation until the causes of error are determined and countermeasures are taken. Failure to follow this precaution may result in damage to the equipment, injury, fire, electric shock and/or burns.
		The equipment might suddenly start operating after recovering from a power failure. Make sure not to go near the equipment. Failure to follow this precaution may result in injury.
		Do not repair, disassemble or remodel the product. Failure to observe this precaution may result in injury, fire, electric shock or burns.
		When performing trial operation, fix the product in place and disconnect it from the machine. Failure to observe this precaution may result in injury.
		When replacing a product equipped with holding brake, make sure to secure the machine side part of the product. Failure to follow this precaution may result in injury and/or damage to the device due to device falling down.

⚠ Caution

		The product must be transported correctly in accordance with its weight.
		When transporting the product, do not hold the product by the cable or output shaft. Failure to follow this precaution may result in damage to the equipment or injury.
		Do not overload/overstack the products. Failure to follow this precaution may result in injury and/or equipment failure.
		When handling the gearmotor, be careful with the sharp edges/points of the device. Failure to follow this precaution may result in injury.
		Fix the gearmotor firmly in place. Failure to follow this precaution may result in damage to the equipment or injury.
		If there is possible risk of dangerous movement due to external forces (such as gravity) during a power outage and/or error, the brake on the gear motor alone cannot ensure safety. For such situations, please be sure to add external brakes to ensure safety.
		Never perform operations with wet hands. Failure to follow this precaution may result in electric shock.
		When operating the gearmotor with Brother driver, please use the specified combination. Failure to follow this precaution may result in fire and/or damage to the equipment.
		Do not touch the gearmotor or driver when the power is on or immediately after turning off the power, as their surfaces may be hot. Failure to follow this precaution may cause burns.
		Immediately stop the operation if there is any abnormality. Failure to follow this precaution may result in fire and/or injury.
		Do not put any combustible material near the product. Failure to follow this precaution may result in fire.
		Operate the product under the conditions specified in this instruction manual. Failure to follow this precaution may result in damage to the equipment or injury.
		Do not put any object that may prevent air from being circulated around the product. Failure to follow this precaution can cause abnormal overheating of the product. It may result in fire or burns.
		Do not stand on or place any heavy object on the product. Failure to follow this precaution may result in injury.
		Be careful not to cause damage to the cable nor pull it strongly. Failure to follow this precaution may result in injury, fire and/or electric shock.
		Do not expose the product to strong impacts/shocks. Failure to observe this precaution may result in failure of the product and/or injury.
		Make sure that the gearmotor is correctly wired. Failure to follow this precaution may result in injury due to damaged equipment.
		Do not touch the rotating part of the gearmotor. Failure to follow this precaution may result in injury.
		In equipments like food machines, which must avoid oil or grease, furnish with protective devices like oil pan, in order to protect from the oil leakage caused by failure or life of the manufactured products. Leaking oil may cause defective products.

Important

When disposing of the product, dispose of it as a general industrial waste. Please follow local laws and regulations if any applies and take care of the waste accordingly.

Notice

We shall assume no responsibility or liability for any troubles caused by use that violates the cautions above.

The contents of this Manual are subject to change without notice.

We have made every possible effort to make the contents of this Manual precise and clear. If there is anything that is unclear or hard to understand, please feel free to contact us. Your comments will be greatly appreciated.

Table of contents

Introduction

Safety precautions

1. Before Using This Product	
1-1 Names of parts and their functions Gearmotor	P . 6
1-2 Things you should check before use Contents of the package	P . 6
1-3 Information provided on nameplate	P . 7
2. Connection Method and Installation	
2-1 Connection method	P . 8
2-2 Motor signal line and power line Signal line colors and functions Connector pin configuration Motor power line colors and descriptions Brake lead wire colors and voltage specifications	P . 9
2-3 Installation Installation location Installation direction Mounting method Tightening torque	P . 10
2-4 Connecting with other equipment When directly connected Attaching Chains, V-Belts, Gears, etc. Installing or removing the hollow bore	P . 10
3. Specifications and Performance	
3-1 Motor and electromagnetic brake specifications Motor specifications Electromagnetic brake specifications	P . 17
3-2 Range of use of gearmotor	P . 18
3-3 When making a driver	P . 20
4. Maintenance, Service Life, and Inspection	
4-1 Maintenance and service life	P . 21
4-2 Periodic inspection	P . 21
4-3 Brake gap adjustment method Adjustment method 50 W 100 W, 200 W, 400 W Toothed lock washer nut mounting method	P . 21
5. Standard Terms and Conditions of Sale	P . 23

1. Before Using This Product

1-1 Names of parts and their functions

■ Gearmotor

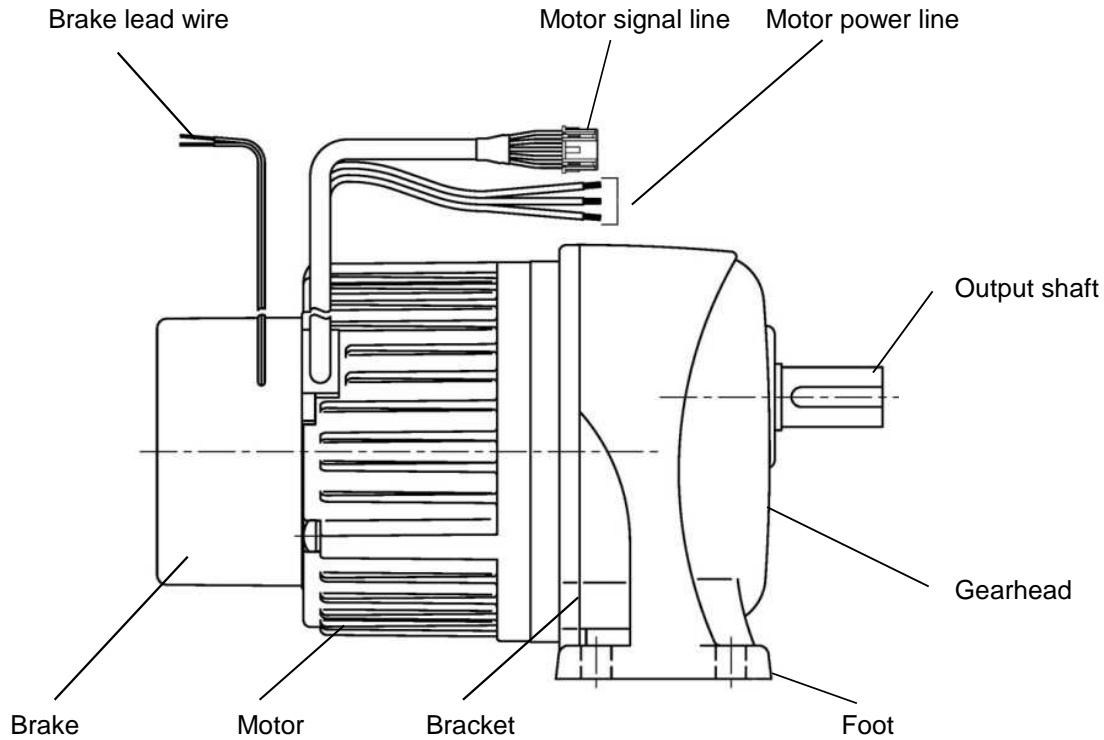

* Its appearance differs according to classification by mount form and motor type.

1-2 Things you should check before use

■ Contents of the package

Check for the following items when unpacking the package.
If there are any defects, or if you have any questions, please contact us immediately.

- (1) Is the information on the nameplate consistent with your order?
Model, reduction ratio, motor capacity, voltage, etc...
- (2) Are there any damaged parts due to an unexpected accident, etc. during transportation?
- (3) Are there any loose nuts or screws?
- (4) Contents of the package

- a) Gearmotor..... 1 unit
- b) Instruction Manual (abridged edition) 1 copy
- c) Surge protector (with brake only)..... 1 piece
- d) Optional parts

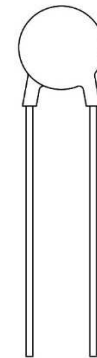

Surge protector
Part Number: ERZV07D820

1-3 Information provided on nameplate

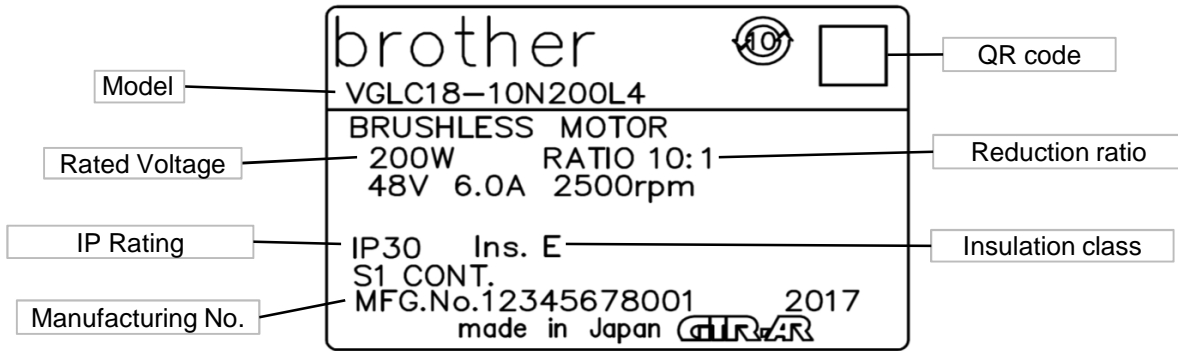

2. Connection method and installation

2-1 Connection method

■ Connect each device as shown in the figure below.

- The length of the cords from the gearmotor is 500mm
- Please use the extension cord (Option) if you need to extend the motor signal cord.
If it is extended by connecting optional extension cords, its overall length must be 4.5 m or less (i.e. up to four extension cords can be used).
- Extension cords are not available for the motor power line and brake lead wire.
Extend it to 5 m or less using cords with a diameter not smaller than the specified wire diameter (P. 17).

Extension cord [1 m]
(optional part: OP-ACDSG1)

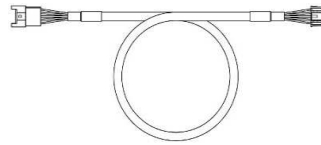

* Shipped with the extension cord having a connector on both ends.

Make the motor power line as short as possible in order to avoid deterioration of motor performance.

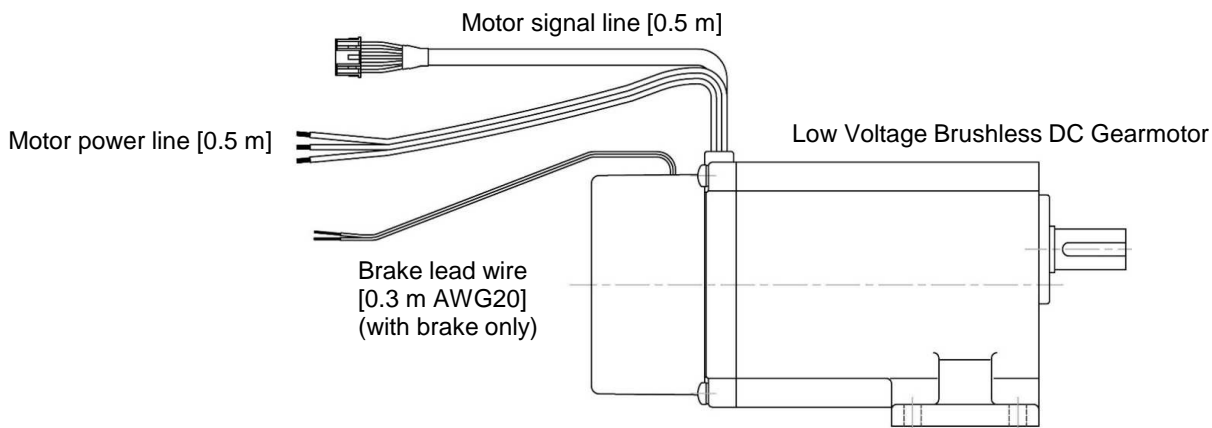

■ Example of connecting to Brother driver

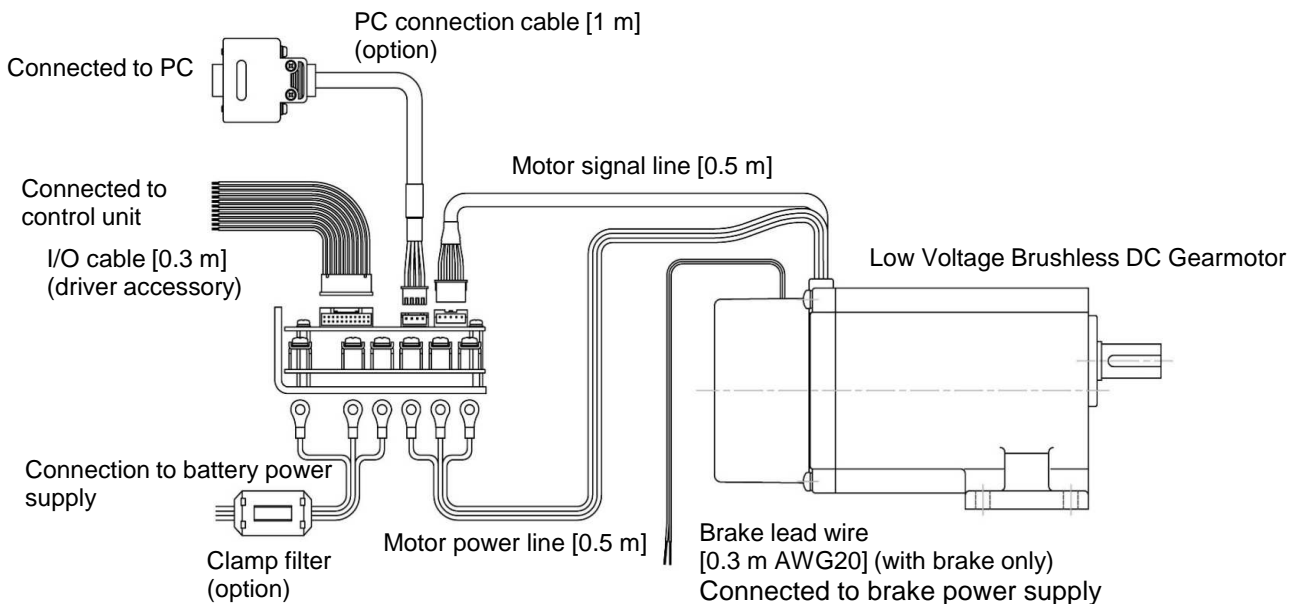

Note: The maximum extension length for the motor signal line, motor power line, and brake lead wire is 5 m. If the motor signal line is extended by connecting optional extension cords, its overall length must be 4.5 m or less (i.e., up to four extension cords can be used).

Note: The motor power line is not equipped with a round terminal. Such terminal must be prepared by the user.

2-2 Motor signal line and power line

■ Signal line colors and functions

Line color	Function
Purple	Pole sensor power supply (15 V for Brother driver)
Orange	U-phase pole signal output (open collector)
Green	V-phase pole signal output (open collector)
Green/White	W-phase pole signal output (open collector)
Gray	GND

■ Connector pin configuration

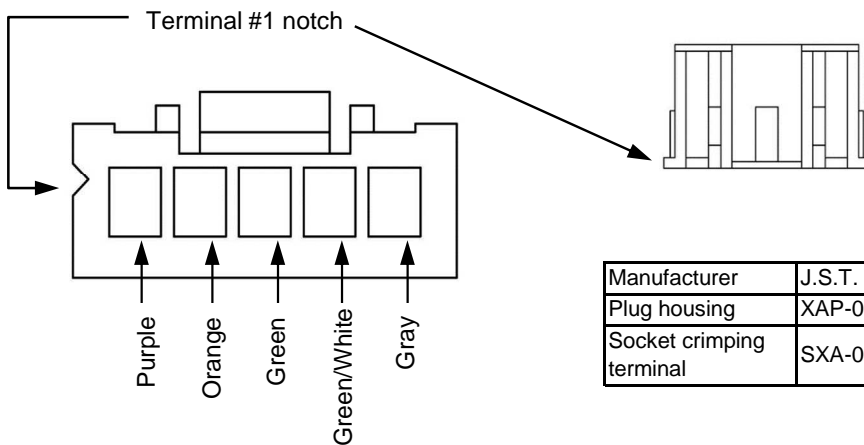

Manufacturer	J.S.T. MFG.
Plug housing	XAP-05V-1
Socket crimping terminal	SXA-001T-P0.6

■ Motor power line colors and descriptions

Line color	Description
Red	U-phase
White	V-phase
Black	W-phase

■ Brake lead wire colors and voltage specifications

Wire color	Voltage specificatio
Yellow	12 V specificatio
White	24 V specificatio
Orange	48 V specificatio

2-3 Installation

■ Installation environment

Ambient temperature: 0 to 40°C

Ambient humidity: 85% or less

Altitude: 1,000 m or lower

Atmosphere: Well-ventilated place free from dust.

Installation location: Indoor

■ Installation direction

There are no limitations on its orientation. (Since it uses a grease lubrication system)

■ Mounting method

[1] Foot and Flange Mount:

Secure it to a vibration-free, machined flat surface (flatness 0.3 mm or less) using four bolts.

[2] Shaft Mount:

- Allow the driven shaft to support the weight of the reducer. (Make sure that the torque arm isn't subjected to forces other than rotation reaction forces.)
- If the motor operation involves frequent starts/stops and/or forward/reverse, make sure the torque arm is fastened firmly in place to eliminate loosening.

■ Tightening torque

Mounting hole (mm)	Bolt diameter	Tightening torque	
		(N-m)	{(kgf-m)}
5.5	M5	2.9	{0.3}
6.5	M6	4.9	{0.5}
8.5	M8	13	{1.3}
9	M8	13	{1.3}
11	M10	25	{2.6}
13	M12	44	{4.5}
15	M14	69	{7.0}
18	M16	108	{11.0}
22	M20	94	{30.0}

2-4 Connecting with other equipment

To attach the connecting devices (coupling, sprocket, pulley, gear, etc.) to the reducer shaft, be sure to use specified keys and provide H7 or equivalent fit tolerance.

■ When directly connected

Shaft center of the connecting machine
Shaft center of the reducer

} Must be aligned in a straight line.

● An example of gear coupling

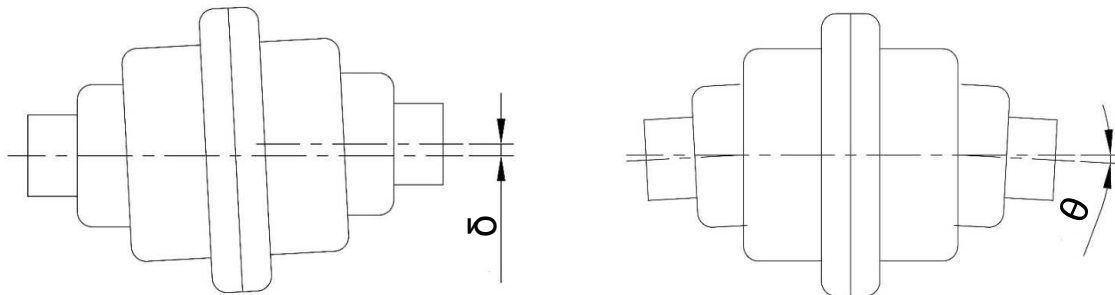

- The δ and θ should be minimized as much as possible.
- The δ and θ differ according to the type of coupling. Therefore, they should be within the allowable value defined by the respective manufacturer.
(Reference: In case of chain coupling, δ should be within 2% of the roller chain pitch and θ should be within 1 (Degree) .)

■ Attaching Chains, V-Belts, Gears, etc.

- (1) Shaft center of the connecting machine } Must be set parallel to each other.
Shaft center of the reducer
- (2) Chain/V-belt tension } Must be at right angle to shaft center.
Gear engagement
- (3) V-belt tension — If it is too tight, the bearing may become damaged.
Chain tension — If it is too tight, the bearing may become damaged. High impact force may also occur if it is too loose which would result in adverse effects on the reducer and application. The tension of the chain should be correctly adjusted.

Correct

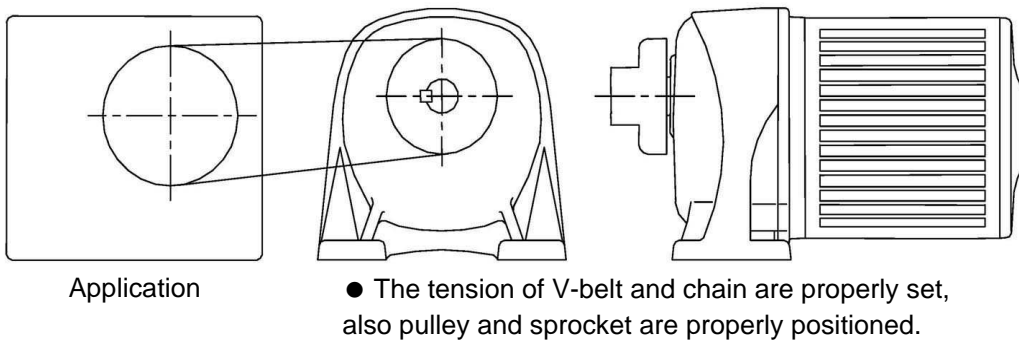

Incorrect

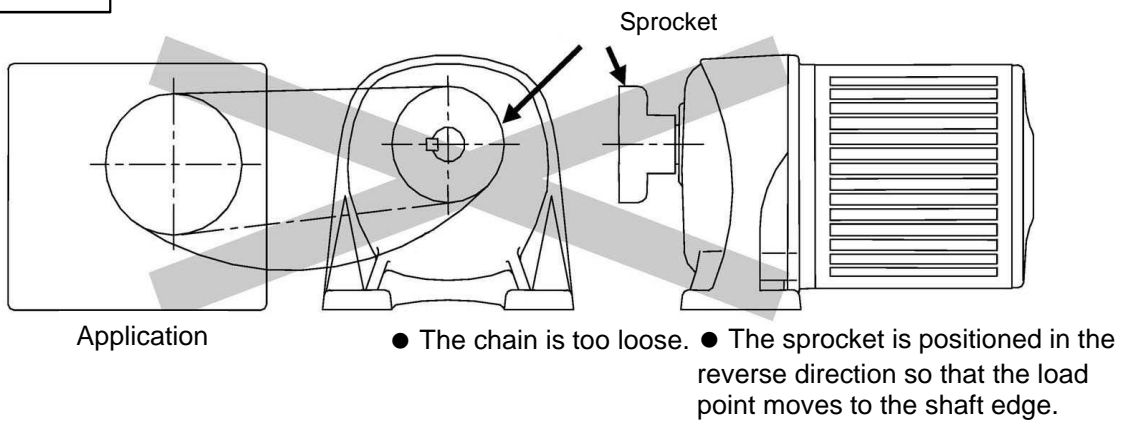

■ Installing and removing the hollow bore

● Attaching the Hollow Bore of the Reducer to the Drive Shaft

- [1] Coat the drive shaft surface and bore surface with a lubricant (molybdenum disulfide) suitable to the atmosphere in which they are used and connect the reducer to the drive shaft.
- [2] When used with uniform loads, a drive shaft tolerance of h7 is recommended. Additionally, when dealing with impact loads or large radial loads, make sure they fit each other tightly. The tolerance of the interior surface of hollow bore is designed to be H8.
- [3] If the shafts are a tight fit, use a plastic hammer on the end of the hollow bore to insert it. When doing so, be sure not to hit the casing. If you make a jig like the one in the diagram below, drive shaft insertion will be easier.

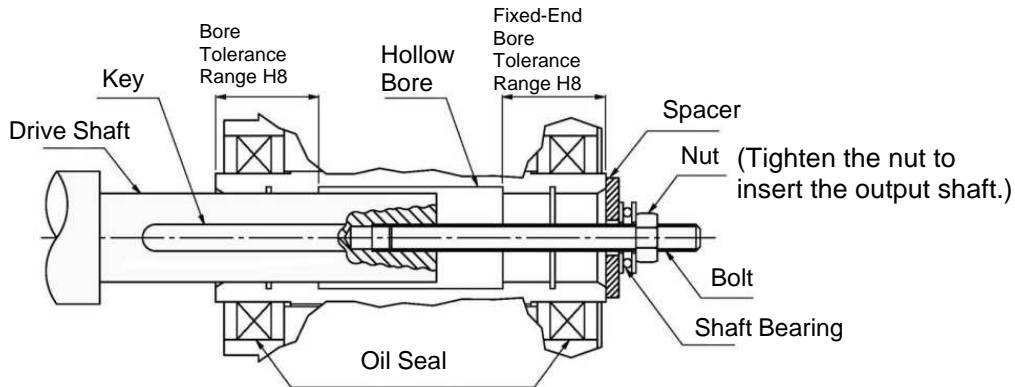

Fig. 1

(Customers need to provide their own spacer, nuts, bolts, keys and shaft bearings.)

- [4] For the length of the turn-stop key for the drive shaft, tolerance range H8 for the bore on the fixed side is recommended.
- [5] It is recommended that axial runout for the shaft be 0.05 mm or less at the shaft end. If major wobbling occurs during operation, it may have a negative effect on the reducer.

● Connecting Reducer to the Drive Shaft

- [1] When there are steps on the drive shaft

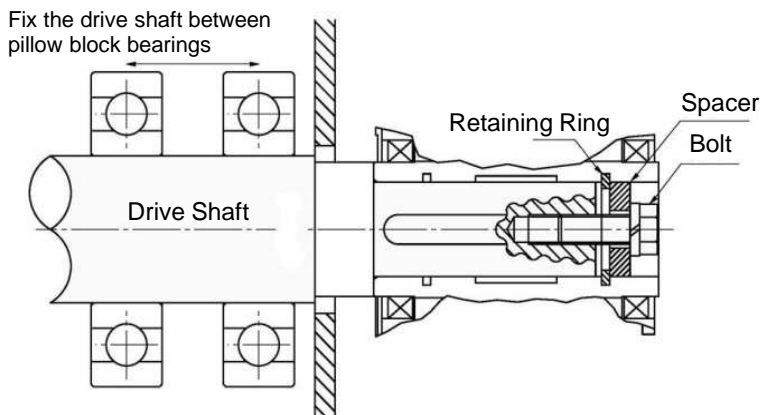

Fig. 2: Attachment Using a Spacer and Retaining Ring
(Customers need to provide their own spacer, bolts, and retaining rings.)

Note: Be careful when tightening the bolt, as tightening it too much can distort the shape of the retaining ring.

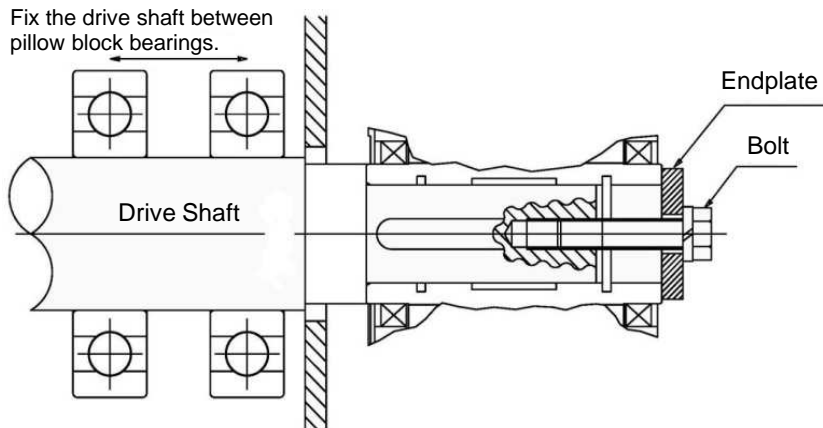

Fig. 3: Attachment Using an Endplate
 (Customers need to provide their own endplates and bolts.)

[2] When there are no steps on the drive shaft

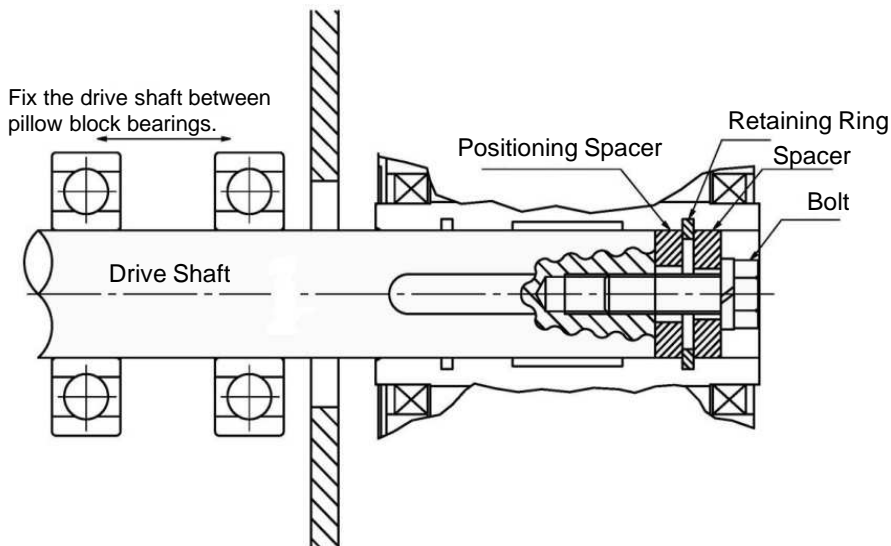

Fig. 4: Attachment Using a Spacer and Retaining Ring
 (Customers need to provide their own spacer, positioning spacers, bolts, and retaining rings.)

Make sure there is a gap between the outer diameter of the spacer and the bore diameter of the hollow bore. If the fit is too tight and the outer diameter of the spacer is inaccurate, burning and axial runout of the drive shaft and hollow bore can result.

The positioning spacer is used to position the reducer. It is not required if you know the length of the drive shaft in advance. In addition, attaching the positioning spacer allows for smooth removal from the hollow bore. (Refer to Fig.5, p.14 for more on removal from the hollow bore.)

● Recommended Sizes for the Fixing Elements of the Drive Shaft

For the attachment of the hollow bore in general use, we recommend you to refer to the dimensions shown on the right as a guide line for the strength when designing.

Recommended Sizes for the Fixing Elements of the Drive Shaft(mm)

Hollow Bore Hole Diameter	Bolt Size	Spacer Dimensions			C-Shaped Retaining Ring for Holes
		Outer Diameter	Inner Diameter	Width	
φ15	M6	φ14.5	φ7	3	15
φ25	M6	φ24.5	φ7	4	25
φ30	M8	φ29.5	φ9	5	30
φ35	M10	φ34.5	φ11	5	35

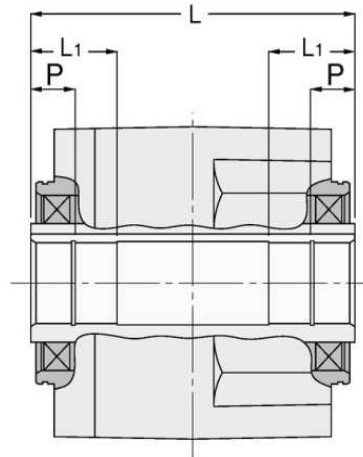
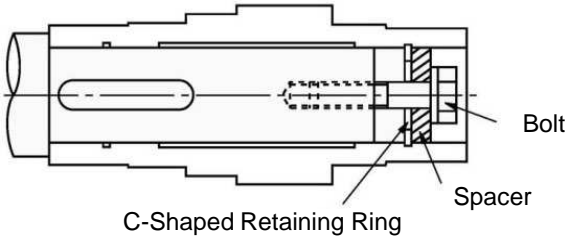

● Drive Shaft Length

Make sure the drive shaft reaches both ends of L1. (See figure at right.) However, look at the dimension leeway for spacers in the section titled "Removal from the Hollow Bore."

● Drive Shaft Key Length

The length of the key should be at least 1.5 times the width of the hollow bore. Additionally, the key is inserted in such a position that at least half its length is in L1. (See figure at right.)

● Removal from the Hollow Bore

Make sure there is room to spare between the casing and the hollow bore. If you make and use a jig like the one below, drive shaft removal will be easier.

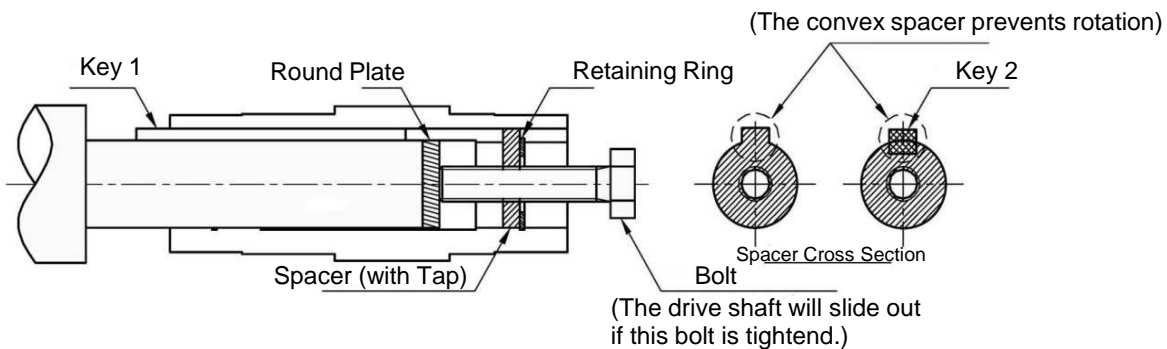

Fig. 5

(Customers needs to provide their own spacers, round plates, bolts and retaining ring keys.)

● How to Install the Reducer

The Advantages and Disadvantages of Flange and Torque Arm Installation

	Advantages	Disadvantages
Flange Installation	<ul style="list-style-type: none"> ● Can be installed directly on the device. ● Saves space. 	<ul style="list-style-type: none"> ● Centering with the application is required.
Torque Arm Installation	<ul style="list-style-type: none"> ● Makes centering with the application easy. ● Fastening to the application only requires one detent. 	<ul style="list-style-type: none"> ● Requires a torque arm. ● Requires space for installing a torque arm.

● Hollow Bore and Flange Installation

When the hollow bore is installed directly to the flange of an application, it can cause motor burn-out or bearing damage if it is off-center, so be sure to center it properly. There is an installation guide, as shown in the diagram at the right. The dimension tolerance for ϕA for the installation guide is h7 in the case of VF3S. The installation bolts are installed as shown in the diagram at the right. Four bolts should be used.

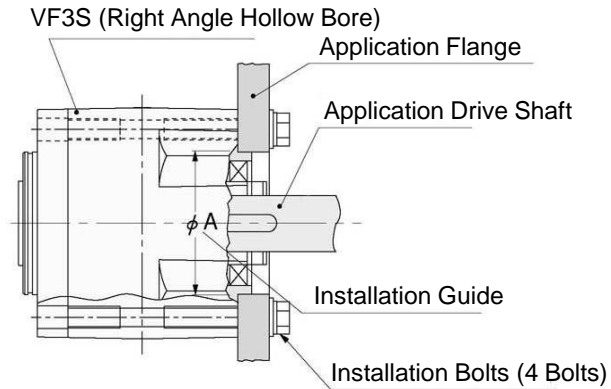

● Detailed diagram of tapped holes for VF3 flange mount installation (standard specification)

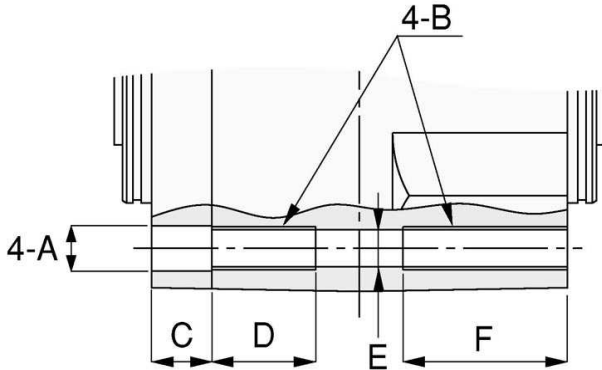

Frame No.	Reduction Ratio	Motor Power	A	B	C	D	E	F
15	1/10 to 1/160	0.1 kW	$\phi 10.5$	M10xP1.5	13	25	$\phi 8.6$	38
25	1/10 to 1/60	0.2 kW	$\phi 10.5$	M10xP1.5	14.5	25	$\phi 8.6$	39.5
30	1/10 to 1/60	0.4 kW	$\phi 10.5$	M10xP1.5	15.5	25	$\phi 8.6$	40.5
	1/80 to 1/240	0.2 kW	$\phi 12.5$	M12xP1.75	15.5	30	$\phi 10.6$	45.5
35	1/80 to 1/240	0.4 kW	$\phi 16.5$	M16xP2	18	40	$\phi 14$	58

When attaching the mounting bolts, it is recommended to have the engagement of the bolt with thread D or F be at least two times the screw size (bolt diameter).(i.e. For an M10, 20 mm or more of thread engagement with D or F is recommended.)

● Fastening the Reducer and Torque Arm

- [1] Because the torque arm sustains a reactive force from rotation, consideration needs to be given to impact loads particularly during startup and braking, and bolts and plates that are sufficiently strong must be used. It's best to use an optional torque arm.
- [2] To install the torque arm and reducer, fasten them using spring washers and flat washers with the installation bolts.

Bolt Size and Tightening Torque
(reference value)

Bolt Size	Tightening Torque N·m {kgf·m}
M8	13 {1.3}
M10	25 {2.6}
M12	44 {4.5}
M14	69 {7.0}
M16	108 {11}

● How to Install the Torque Arm Detent

[1] Oscillating Movement

Fasten the torque arm detent so there is no looseness or wobble. When doing this, center the detent hole with that of the application to make sure that no radial load (suspension load) is applied against the drive shaft and hollow bore of the reducer. (See Fig.6)

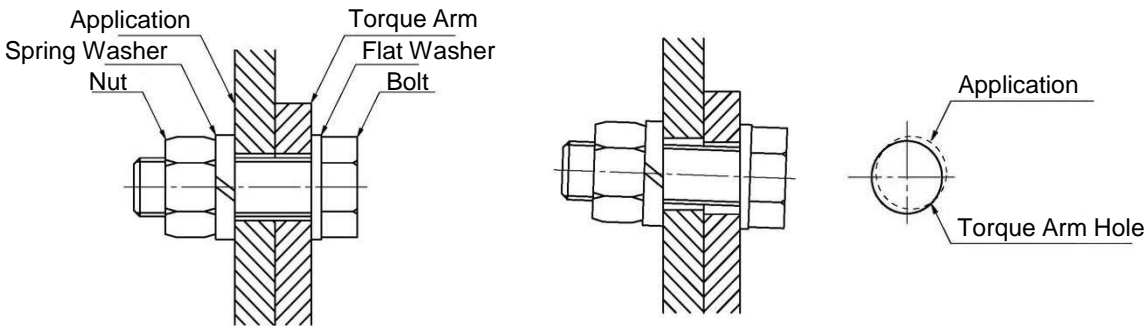

Fig. 6: Fastening the Detent

Unnecessary force applied to the drive shaft and hollow bore can result in defects.

Bad Example

Note: If looseness develops due to oscillating movement or start and stop frequency, start-up impact will be borne by the torque arm, causing the installation bolt to loosen, which can result in defects.

[2] Unidirectional Movement

When start-up torque is not frequently applied, the torque arm can be used without a detent. However, it is still necessary to fasten the drive shaft to the reducer. Refer to figures 2-4 on pages 12-13.

In this case, it is necessary to provide sufficient clearance for looseness in both radial and thrust directions for alignment between the application and detent. (See Fig. 7.)

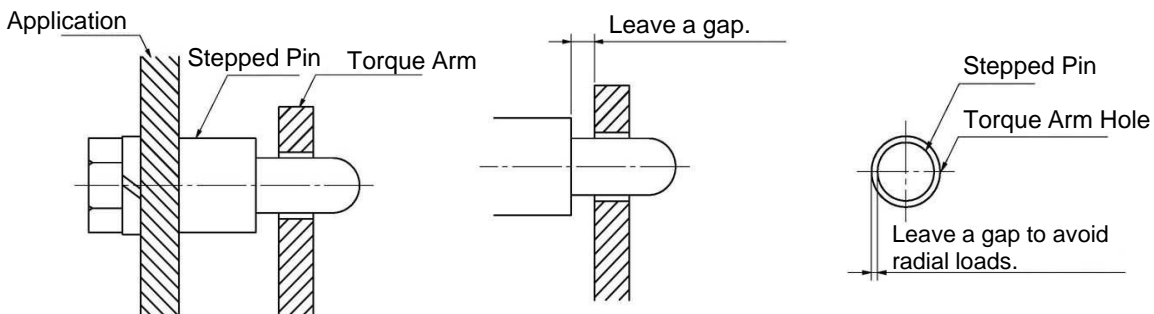

Fig. 7: Example of Stepped Pin Usage

3. Specifications and Performance

3-1 Motor and electromagnetic brake specifications

■ Motor Specifications

Motor Power Item	50W		100W			200W		400W	
Motor	Brushless Motor								
Voltage (V)	12	24	12	24	48	24	48	24	48
Rated Current (A)	5.9	2.7	12.4	5.8	2.7	9.8	5.1	20.1	9.9
Wire Size (mm ²)	0.9 (AWG18)		2 (AWG14)						
Maximum Extended Length (m)	5								
Ambient Temperature (°C)	0~40°C								
Ambient Humidity (%RH)	85%RH or less (no condensation)								
Ambient Storage Temperature (°C)	-10 to 60°C (no freezing)								
Ambient Storage Humidity (%RH)	85%RH or less (no condensation)								
Vibration	0.5 G or less								
Altitude	1,000 m or lower								
Atmosphere	No corrosive gasses, flammable gasses or steam. Environment should be dust-free with good ventilation.								
Installation Location	Indoor								

* The rated current values in the table above are values for the motor unit only (gearhead removed).
For gearmotor information, see p.18-19.

■ Electromagnetic Brake Specifications

Motor Power Item	50W		100W			200W		400W	
Brake Type	Power-Off (Spring Close)								
Static Torque [Motor Shaft] (N·m)	0.20		0.57			0.95		1.76	
Excitation Voltage (±10%) (V)	12	24	12	24	48	24	48	24	48
Current Draw (20°C) (A)	0.44	0.25	0.65	0.36	0.17	0.58	0.28	0.58	0.31
Power Draw (20°C) (W)	5.3	6.0	7.8	8.6	8.3	13.9	13.2	13.9	15.1
Wire Size (mm ²)	0.5 (AWG20)								



Be sure to insert a Surge protector to protect the driver from surge generated by turning on/off the electromagnetic brake. Use the varistor (82 V, 1J or higher) included in the package or a diode (100 V, 1A, or higher).

3-2 Gearmotor Characteristics

The coefficient of rotation speed to load and the coefficient of current draw to load for gearmotor units are shown in these graphs. These characteristics are gearmotor unit characteristics. Customers may refer to these graphs when creating drivers. Standards for usage that conform to time ratings (5 sec. and 30 sec.) are shown, but we ask that our customers confirm this on their application.

- * The rotational speed in the graphs below corresponds to the motor shaft. Use the gear ratio to calculate the output rotational speed.
- * In the graphs below, 100% corresponds to output allowable torque in the performance tables.
- * When operating inside the limited duty range, there is the possibility that the life of the gearmotor will be reduced and that electromagnetic brakes will have reduced braking power. Contact our company for more details.

When using a Brother driver

- Used within the rated speed range (100 to 2500 r/min) at 100% load factor.

— Load factor – Rotation speed
 — Load factor – Current

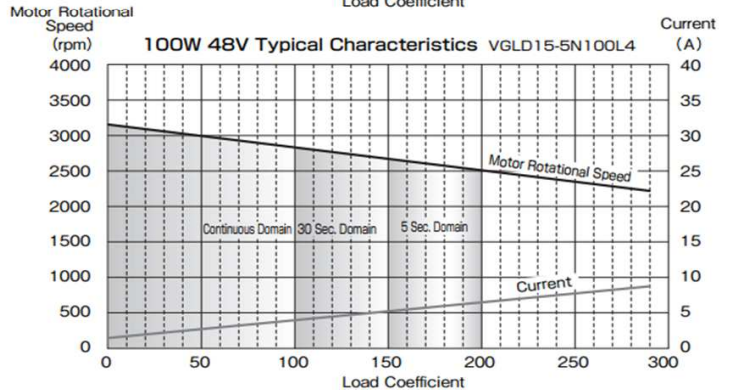
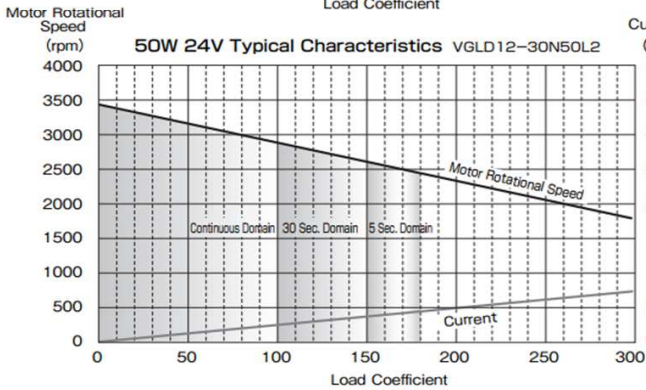
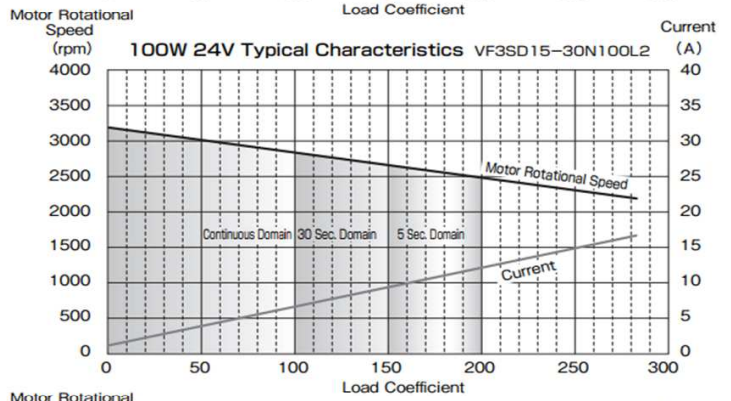
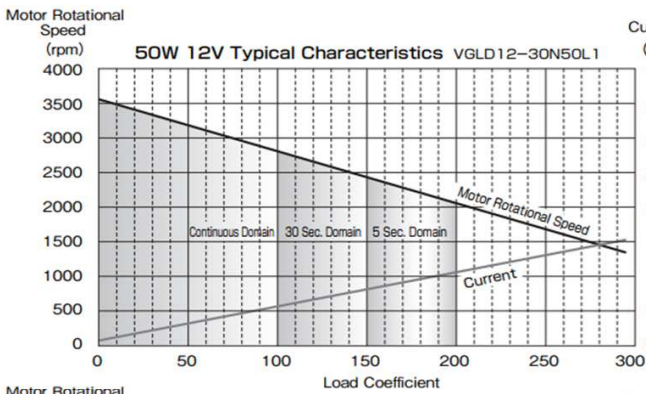
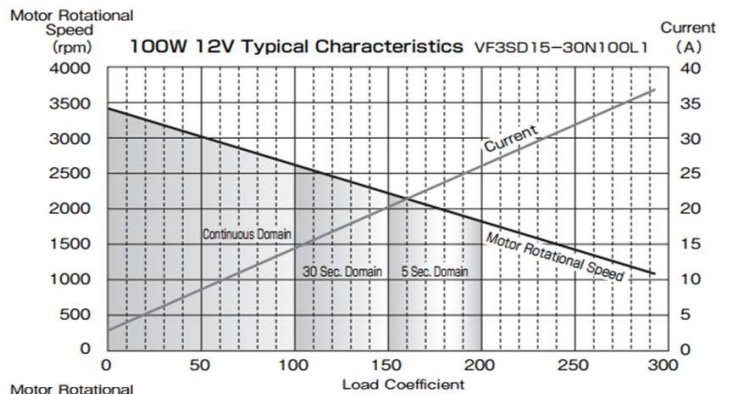

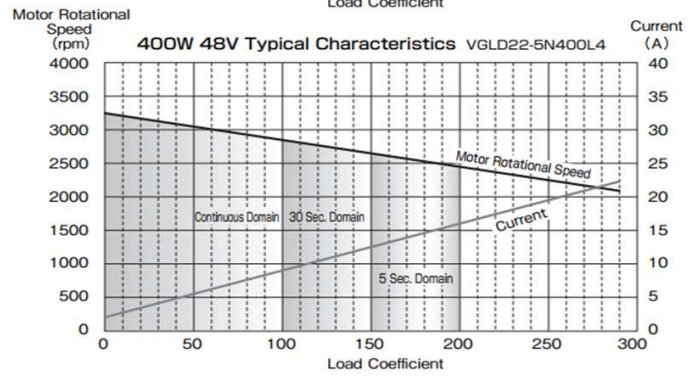
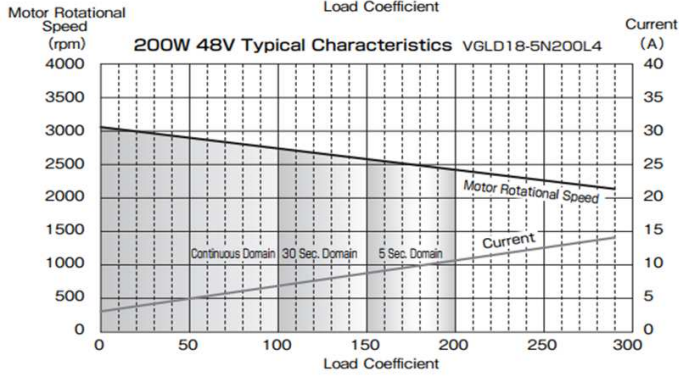
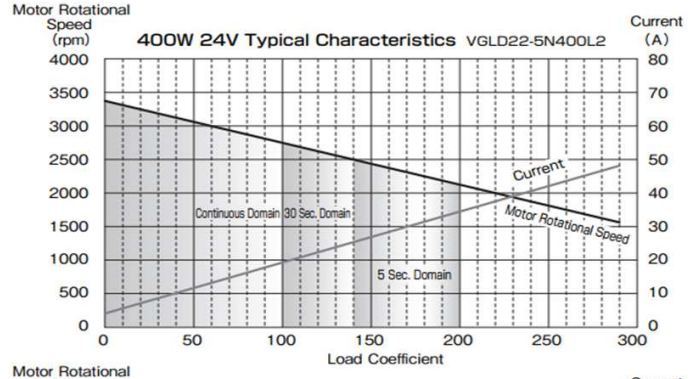
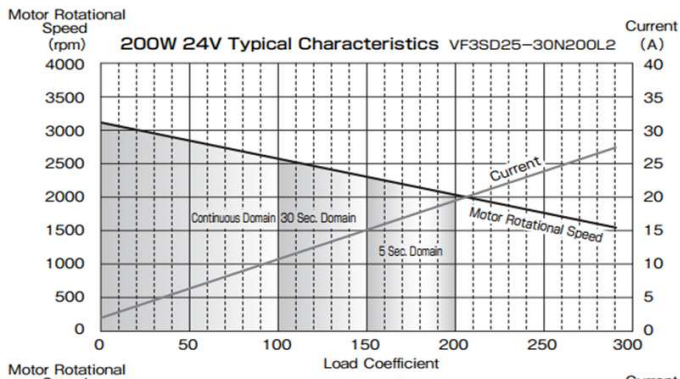

3-3 When making a driver

■ Type and specifications of Hall IC

Manufacturer: Asahi Kasei Microdevices Model: EW-500

Power supply voltage	18 V
Output current	15 mA
Operating temperature	-20 to 115°C

■ Excitation pattern

- It rotates in the forward direction as illustrated below.
- Excitation current flows when rotating in the reverse direction.

Signal transition

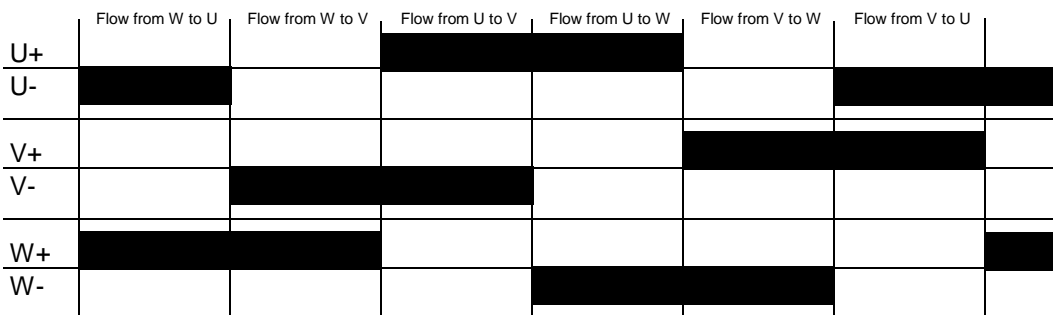
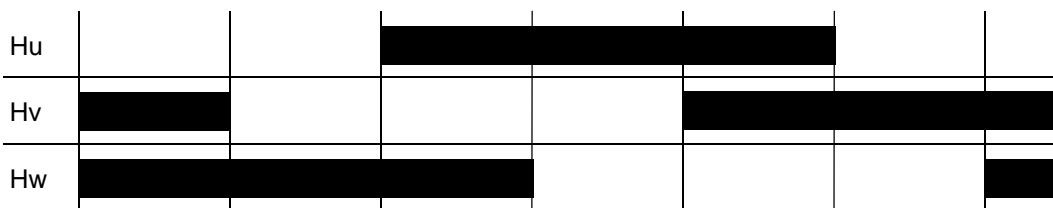

ON indicated by the zone

■ Specifications of motor and electromagnetic brake

- Electromotive force constant and torque of a single motor are described below.

Characteristics of the motor	50 W		100 W			200 W		400 W	
	12 V	24 V	12 V	24 V	48 V	24 V	48 V	24 V	48 V
Electromotive force constant (V/kr/min)	1.42	2.95	1.33	2.89	6.08	3.15	6.00	2.97	6.06
Torque constant (Nm/A)	0.031	0.007	0.029	0.059	0.120	0.069	0.128	0.071	0.145
Line resistance (Ω) at 20°C	0.168	0.661	0.048	0.184	0.835	0.087	0.320	0.044	0.130

- The resistance values of the electromagnetic brake are described below.

Characteristics of the electromagnetic	50 W		100 W			200 W		400 W	
	12 V	24 V	12 V	24 V	48 V	24 V	48 V	24 V	48 V
Coil resistance (Ω) at 20°C	19.8	96.4	18.4	66.9	282.5	41.6	174.1	41.6	154.5

4. Maintenance, Service Life, and Inspection

4-1 Maintenance and service life

- All models that we offer use a grease lubrication system and do not require grease replacement/replenishment.

The gearmotor is designed for 10,000 hours of operation.

- The service life of the oil seal differs according to use conditions. It may need to be replaced before it has reached 10,000 hours.

4-2 Periodic inspection

Gearmotor inspection items are described in the table below.

Please determine the best inspection timing based on the inspection frequency described below while taking into account usage conditions/environment.

Inspection items	Inspection frequency	Inspection and maintenance procedure	Remarks
Connectivity between motor and machine.	Before starting operations	<ul style="list-style-type: none"> • Make sure that the gearmotor-machine mounting screws are tight enough. • Make sure that the gearmotor-is firmly connected to the load. • Check for misalignment. 	-
Vibrational and acoustic check	Every day	<ul style="list-style-type: none"> • Make tactual and aural checks. 	No increase from the normal sound level
Appearance check	Whenever required	<ul style="list-style-type: none"> • Perform cleaning with a cloth, compressed air, etc. 	-
Checking for grease leakage	Every 2 or 3 days	<ul style="list-style-type: none"> • Make sure that the connections of the gearmotor case, oil seal, bracket, etc. are free from leakage. 	-

4-3 Brake gap adjustment method

This is a holding brake.

It is not necessary to make gap adjustments for normal use. However, if this brake is repeatedly used for emergency purposes, etc., the brake friction disc will wear very quickly, resulting in a wide gap.

If this is the case, the brake cannot be released; refer to the method described below and adjust the gap.

 DANGER
<ol style="list-style-type: none"> 1 When making cap adjustments, make sure that the power is OFF. Failure to observe this precaution may result in injury. If the toothed lock washer nut is removed, pay attention to its mounting direction. If you fail to put it back into its correct position, it may become damaged. For its correct position, see P .22 Toothed lock washer nut mounting direction. 2 After completion of gap checks/adjustments, turn the power on and off and check the operation of the brake before the start of full-scale operation. Falling/runaway accident may occur. 3 After inspection/adjustment, be careful not to operate the motor with the brake cover removed. You may get caught in the motor, resulting in serious injury.

[Adjustment method]

■ 50 W

- (1) Remove the brake cover [5].
- (2) Loosen the setscrew [4].
- (3) Put a 0.2 mm feeler gauge in the gap g2 part, hold the friction disc [3], and loosen the setscrew [4].
- (4) Remove the feeler gauge.

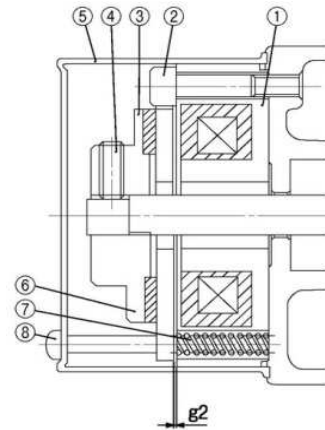

- | | |
|------------------------------|-------------------------------|
| [1] Field | [6] Armature |
| [2] Hex socket Head Cap bolt | [7] Spring |
| [3] Friction disc assembly | [8] Brake cover setting screw |
| [4] Setscrew | |
| [5] Brake cover | |

Acceptable gap : $g2 = 0.2 \pm 0.1$

■ 100 W, 200 W, 400 W

- (1) Remove the brake cover [9].
- (2) Disengage the castellated nut [6] from the groove in the friction disc [3].
- (3) Tighten the castellated nut [6] to slightly lock it.
($g1 = 0.2$ in this condition)
- (4) If the castellated nut [6] is removed, pay attention to its mounting direction.
(See the toothed lock washer nut mounting direction shown in the figure below.)
- (5) Bend the castellated nut [6] nearest to the friction disc [3].

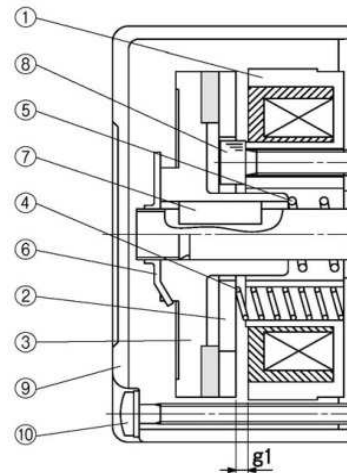

Acceptable gap : $g1 = 0.4 \pm 0.1$

- | | |
|-------------------|--------------------------------|
| [1] Field | [6] Castellated Nut |
| [2] Armature | [7] Key |
| [3] Friction disc | [8] Hex socket Head Cap bolt |
| [4] Spring 1 | [9] Brake cover |
| [5] Spring 2 | [10] Brake cover setting screw |
- g1: Gap

■ Castellated nut mounting direction

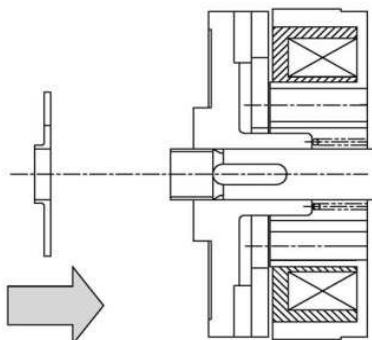

5. Standard Terms and Conditions of Sale

■ General

These standard Terms and Conditions of Sale shall be incorporated into any contract between Purchaser and Brother International Corporation (hereafter Brother) and shall apply to all purchase orders issued by Purchaser. Unless specifically provided herein or in a separate written agreement duly executed by Brother, the quotation and this form constitute the entire agreement between Brother and Purchaser and no other terms or conditions oral or written shall be of any effect. All orders, whether placed pursuant to a quotation or not, are accepted only upon express condition that purchaser agrees to the Terms and Conditions as specified herein.

■ Price and Delivery Terms

Price and delivery terms are F.O.B. Brothers nearest U.S. facility and do not include sales, use, excise, or any other taxes. Our responsibility ceases when delivery is made to the transportation company and any claims for loss or damage in transit must be handled by the Purchaser with the carrier.

■ Packing

No charge is made for standard boxing for domestic shipments. Purchaser will be quoted and charged separately for export or special packing requirements.

■ Payment Terms

To Purchasers with credit standing satisfactory to Brother, terms of payment are cash in full, net 30 days. If at any time Brother deems that by reason of financial condition of the Purchaser or otherwise, the continuance of production or shipments is not justified, Brother may revoke its extension of credit, enforce any security interest(s) created hereby on all goods furnished by Brother to the Purchaser and otherwise secure itself as to Purchasers performance of its obligation.

■ Cancellation

Changes, suspension or cancellation of any order by Purchaser may be made only upon written approval of an authorized officer of Brother.

■ Warranty

All Brother gearmotor product are warranted against defects in materials and workmanship for a period of 2 years from the date of manufacture. This constitutes Brother's only warranty in connection with this sale, and is in lieu of all other warranties expressed or implied, written or oral. There are no implied warranties of merchantability or fitness for a particular purpose that apply to this sale. If performance guarantees are requested, they should be requested in writing. Full consideration will be given to such requests when complete details of the proposed application are included.

■ Limitation of Remedy

Brother will repair or replace, at brother's option, F.O.B. Brother's factory, freight prepaid, any Brother gearmotor proved defective in materials or workmanship if immediate written notice of claim is made to Brother by Purchaser within 2 years from the date of manufacture. It is agreed that such repair or replacement is the exclusive remedy available from Brother. Under no circumstances shall Brother be liable to anyone for any special, incidental or consequential damages, whether the result of negligence or otherwise.

■ Warranty Exclusions

The warranty of Brother gearmotor products does not cover and Brother makes no warranty with respect to:

1. Failures not reported in writing to Brother within the warranty period of 2 years after the date of manufacture.
2. Failures or damages due to miss-application, abuse, improper installation or abnormal conditions of temperature, humidity, dirt or corrosive matter.
3. Failures due to operation, either intentional or otherwise, above rated capacities or in an otherwise improper manner.
4. Product which has in any way been tampered with or altered by anyone other than an authorized representative of Brother.
5. Expenses incurred by the Purchaser in an attempt to repair or rework an allegedly defective product.
6. Product damaged in shipment or otherwise without the fault of Brother.

■ Returns

No product will be accepted for return unless authorized in writing with a returned merchandise authorization (RMA) number assigned. Any returned goods must be returned with transportation charges prepaid.

■ Regulatory Laws and/or Standards

It is the Purchaser's obligation to install and operate all Brother gearmotor products in conformance with all applicable national or local laws and safety codes.

■ Patents

Brother represents that its gearmotors are designed and manufactured such that they do not infringe on any United States Patent(s), and that Brother will, at its expense, defend any claim charging such infringement and will save Purchaser harmless from any adverse judgements resulting there from. Purchaser agrees to give Brother, prompt written notice of any claim of infringement and to turn over to Brother the complete control of any litigation involving such claims including the right to settle such claims. This indemnity does not apply to Products which are incorporated by the Purchaser into Products which are changed to infringe a Patent or to Product which is used by Purchaser in performance of a method or process which is charged to infringe a Patent.

■ Law

These Standard terms and Conditions of Sale shall be interpreted in accordance with the Laws of the State of New Jersey.

■ Severability

If any of the terms and Conditions shown here are determined to be invalid, illegal, or unenforceable the remainder of these Terms and Conditions shall remain in full force and effect.

brother
at your side

Brother International Corporation

Gearmotor Division

200 Crossing Blvd. Bridgewater, NJ 08807

Phone: 866-523-6283 | Fax: 908-704-8235

www.BrotherGearmotors.com

E-mail: GearMotors@brother.com